



## Operating Instructions

**SDD 1 SGM**  
**with S 150 control unit**

SM1-671

**Sterling Material Processing**  
5200 West Clinton Ave.

Milwaukee, WI 53223

Telephone (414) 354-0970

Fax: (414) 354-6421

www.sterlco.com

**Parts & Service department:**

Telephone: (800) 423-3183

**Edition: 07/01**

This operation manual is for\*:

(\* Please fill in personally)

Serial number: \_\_\_\_\_

Built in: \_\_\_\_\_

Date of delivery: \_\_\_\_\_

Number of delivery: \_\_\_\_\_

Date of commissioning: \_\_\_\_\_

Location: \_\_\_\_\_

Group of machines: \_\_\_\_\_

SM1-671

Sterling Material Processing retains all rights to change the information in these operating instructions at any time without notice.

We assume no liability for any errors or direct or indirect damage resulting in context with these operating instructions.

Copying, translation or publication in any form except for personal use of purchaser requires approval from Sterling Material Processing.

All rights reserved.

## Table of contents

<b>1. Safety instructions</b> .....	<b>1-1</b>
1.1. For your safety .....	1-2
1.2. For the operating safety of the equipment .....	1-4
<b>2. Concerning these Operating Instructions</b> .....	<b>2-1</b>
2.1. Warning Messages and Symbols .....	2-2
2.2. Explanations and Definitions .....	2-3
2.3. Notes on Usage .....	2-3
<b>3. Putting into operation.</b> .....	<b>3-1</b>
3.1. Control System S 150 .....	3-2
3.1.1. Key Assignment .....	3-3
3.1.2. Symbols .....	3-4
3.2. Initial operation procedure .....	3-5
3.3. Basic Parameter Setting .....	3-9
3.4. Calibration .....	3-12
3.4.1. Preparations .....	3-12
3.4.2. Determining the Calibration Weight .....	3-14
3.4.3. Preparing the Feed Station for Normal Operation .....	3-16
3.5. Modify/Create Recipe .....	3-17
3.5.1. Save Recipe .....	3-20
3.6. Starting mode .....	3-21
3.7. Starting the Continuous Operation .....	3-21
3.8. Viewing the Actual Values .....	3-22
3.9. Stopping the Continuous Operation .....	3-22
3.10. Calling up the recipe .....	3-23
3.11. Switching off the Device .....	3-23
3.12. Alarm Messages .....	3-24
<b>4. Maintenance</b> .....	<b>4-1</b>
4.1. Maintenance intervals .....	4-3
4.2. Removing/replacing scraper in the SDD dosing station .....	4-4
4.3. Cleaning the SDD dosing station .....	4-6
4.4. Changing the dosing disc in the SDD dosing station .....	4-8
4.4.1. Installing Different Types of Dosing Discs .....	4-10
4.5. Removing/replacing the scraper in the SDT dosing station .....	4-11
4.6. Cleaning the SDT dosing station .....	4-13
4.7. Exchangeable stations .....	4-15
4.8. Exchanging Fuses .....	4-16

**5. Assembly instructions . . . . . 5-1**

    5.1. Transport . . . . . 5-2

    5.2. SDD 1 SGM . . . . . 5-2

        5.2.1. Mounting on the processing machine . . . . . 5-3

    5.3. Control system S 150 . . . . . 5-4

    5.4. Electrical Connection . . . . . 5-5

**6. Functional description . . . . . 6-1**

    6.1. SDD 1 SGM . . . . . 6-2

    6.2. Control Unit S 150 . . . . . 6-2

**7. Technical Data . . . . . 7-1**

    7.1. SDD 1 SGMI . . . . . 7-1

    7.2. Control unit S 150 . . . . . 7-2

    7.3. Dimension sheet . . . . . 7-3

**8. Spare parts list . . . . . 8-1**

**9. Accessories . . . . . 9-1**

Drilling jig

Values required for the basic parameter

Level probe KCB-M32GP/015

-----

-----

**10. Electrical manual . . . . . 10-1**

## 1. Safety instructions



These safety instructions apply to all persons within the range of action of the equipment.

Please inform all persons within the range of action of the equipment of the direct and indirect hazards connected with the equipment.

These operating instructions are to be used by all persons assigned activities connected with the equipment.

Knowledge of the English language is prerequisite.

Ensure in each case that the operating personnel are familiar with the operating instructions and the function of the equipment.

## **1.1. For your safety**

### **General**

The operating personnel of this equipment must be at least 16 years old.

Please read these operating instructions carefully before taking into operation for the first time. Contact us should questions arise. This avoids injury and damage to equipment!

These operating instructions must be kept available at all times at the place of operation of the equipment. Improper operation results in danger of accidents!

Please note that, for reasons of clarity, not all conceivable cases regarding operation or maintenance of the equipment can be covered in these operating instructions.

Please observe all safety instructions and warnings on the equipment. This avoids injury and damage to equipment!

All work on the equipment is to be carried out by persons whose qualifications are specified in the pertaining chapters of the operating instructions. Improper operation results in danger of accidents!

The proper working clothes are to be worn during any work on the equipment. This avoids injury!

The local regulations and requirements pertaining to this equipment must be observed.

Disconnect electrical components from the mains supply before work is carried out on these components. Caution: Danger to life through electrical shock!

Compile detailed operating instructions based on these Operating instructions for the sequence of procedures to be carried out on this equipment. Improper operation results in danger of accidents!

### **Assembly**

Compare the connected loads with those of the mains supply. Danger of injury through electrical shock!

When using lifting gear, please observe the pertaining regulations. Caution: Danger of accidents!

Do not modify, add other equipment or change the design of the equipment without the approval of the manufacturer. Caution: Danger of accidents!

Attachments not supplied by Sterling must be manufactured in accordance with safety instruction EN 294. Caution: Danger of accidents!

The equipment may only be operated when all the associated components are properly connected up and in accordance with the relevant regulations. This avoids injury and damage to equipment!

Operate the device only if all its components are grounded. Danger: accident through electrical shock!

Please note for installation that the equipment is top-heavy. Danger exists that it may topple over!

### **Operation**

Appoint an equipment foreman to be responsible for the equipment.

Ensure that the operating personnel are provided detailed instruction in the operation of the equipment. Improper operation results in danger of accidents!

When the main switch is switched off for reasons pertaining to safety, it must be secured against unauthorized activation. Caution: Danger of accidents!

Repair work may be carried out by trained personnel only. Caution: Danger of accidents!

Never operate the equipment when partially dismantled. Caution! Danger exists that limbs may be caught; danger of electrical shock!

In case of malfunction, shut down the equipment immediately. Have malfunctions corrected immediately. Caution: Danger of accidents!

The equipment is intended only for dosing granulated plastics and additives. Other use of the equipment is contrary to its specifications.

This equipment is not suitable for foods processing.

Observe the safety instructions for connected equipment.

The device may only be started up if all feed stations and blind lids have been mounted or if there is a weighing container in the intermediate piece for proportioning. Danger: Limbs may be caught in machinery!

### **Maintenance**

Before starting maintenance work, appoint a supervisor.

Inform the responsible personnel before maintenance work on the system is started. Caution: Danger of accidents!

Disconnect the equipment from mains supply before starting maintenance procedures to ensure that it cannot be switched on unintentionally. Caution: Danger of accidents!

Check all lines, hoses and screwed connections regularly for leaks and obvious damage. Repair damage immediately. Caution: Danger of accidents!

Never reach into a dosing station or an intermediate piece for dosing while the control system is still connected to the power supply. Danger of squeezing!

When handling the scraper be careful, the scraper is sharp. Danger of injury exists!

Wait at least one minute before starting to work at the switching cabinet. Danger to life! Discharge of high-voltage possible!



## **1.2. For the operating safety of the equipment**

Never change settings if the consequences are not precisely known.

Use only original Sterling spare parts.

Please observe the maintenance intervals.

Keep record of all maintenance and repair procedures.

Observe precautions for handling electrostatic sensitive devices.

Check all electrical connections for proper fit before the equipment is taken into operation for the first time and at regular intervals.

The control system may be operated only at temperatures from 0 to 50 °C (32 to 120 °F).

The control system may only be stored at temperatures from -20 to +70 °C (-4 to +160 °F).

Note down all setting data entered in the control system.

Check the rotational direction of the dosing motor before taking into operation (see rotational direction arrow).

Ensure that all plugs are properly connected.

Never connect conveying equipment with the dosing stations without the corresponding supports.

Ensure that the machine flange has sufficient carrying capacity.

Please note that the dosing motor may reach temperatures of up to 70 °C (160°F) during continuous operation.

Please observe the operating instructions of the connected equipment.

All components must be sufficiently grounded.

In case the temperature within the housing of the control system exceeds 85°C (185°F), the control system will be automatically switched off.

## 2. Concerning these Operating Instructions



These operating instructions are addressed to all users of the device.

These operating instructions must be used by every person charged with work on the unit.

## 2.1. Warning Messages and Symbols

The following warning messages and symbols are used in these operating instructions:



This symbol indicates danger to life! Fatal or serious injury is possible if the corresponding instructions, regulations or warnings are not observed.



This symbol indicates that serious injury is possible if the corresponding instructions, regulations or warnings are not observed.



This symbol indicates that extensive damage to equipment is possible if the corresponding instructions, regulations or warnings are not observed.



This symbol indicates information important for becoming familiar with the equipment, i.e. technical correlations.



This symbol indicates that a technical term is explained at this point.

## **2.2. Explanations and Definitions**

In this operating manual, certain terms are used repeatedly for better clarity. Therefore please keep in mind that these terms stand for the explanations given here.

- **Unit**  
“Unit” may designate either a single device, a machine or a plant.
  
- **User**  
The user is the person who uses the unit on his or her own responsibility or on the responsibility of someone else.
  
- **Operator**  
The operator of a unit (production manager, foreman etc.) is the person responsible for the sum of the processes. The operator instructs the users to do something.
  
- **Operating manual**  
The operating manual describes the correlations between several units, processes or manufacturing procedures. The operating manual must be prepared by the operator of the units.
  
- **Co-ordinator**  
If several users work on one unit, the “co-ordinator” co-ordinates the processes. The co-ordinator must be designated by the operator.
  
- **Trained personnel**  
Trained personnel are people who are qualified by their training to carry out the respective work in a professional manner.

## **2.3. Notes on Usage**

- Experienced operators of dosing systems can begin directly with the chapter on “Putting into Operation” if the unit has been properly installed.
  
- If the unit has not been installed yet, observe the instructions in the chapter on “Assembly Instructions”.

---

**Concerning these Operating Instructions 2-3**

### 3. Putting into operation



This chapter is intended for operating personnel.

Prerequisite for this chapter is general knowledge of the operation of dosing and blending units on injection moulding machines.

Also prerequisite for this chapter is that the functional description has been read and understood.

Ensure in each case that the operating personnel are sufficiently informed.



LED = light emitting diode

“bzw.” = “or”

### 3.1. Control System S 150

The Control system is switched on by means of the On/Off switch (switch set in position "1"). The control system is operated via the key board (B). The individual operating modes are indicated by symbols (C). Messages appear on a 4-digit display (D). Up to ten recipes can be saved and read on request. recipes can be assigned respective numbers.

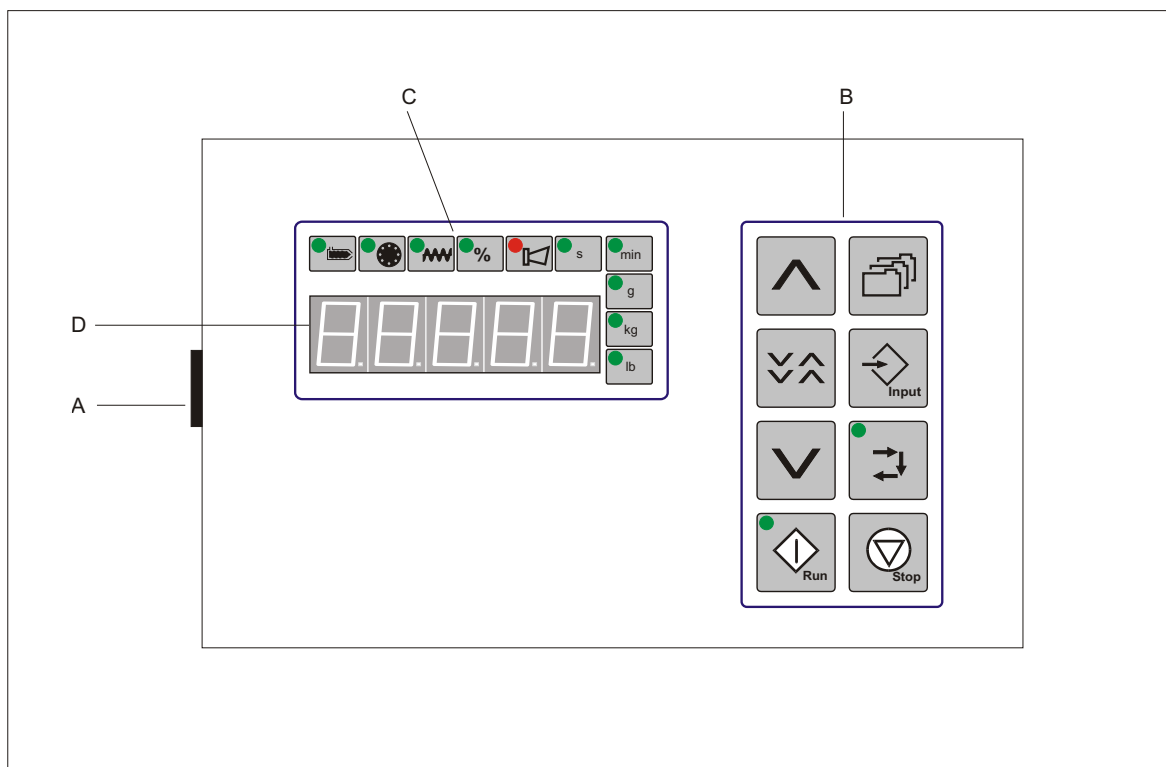

S 150

### 3.1.1. Key Assignment



“recipe”  
For saving, calling up or modifying recipes

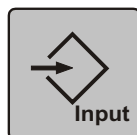

“input”  
For the input of program parameters

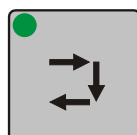

“calibration”  
Switches to the calibration mode, the LED flashes in case the calibration process was started by pressing the “run” key.  
Starts the starting mode if the key is depressed for more than 2 seconds.



“stop”  
Stops the continuous operation or the weighing procedure; will set the metered amount of additive to zero if the key is depressed for more than 2 seconds.



“run”  
Starts the continuous operation (the LED is lit up) or the calibration mode (the LED flashes).



arrow key  
for increasing the set value



arrow key  
for decreasing the set value



arrow key  
for quick in- or decreasing of the set value (the key must be pressed simultaneously with the key for in- or decreasing the set value).

### 3.1.2. Symbols

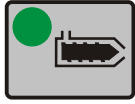

“Screw retract time”

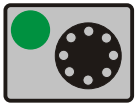

“Dosing disc”



“Screw speed”

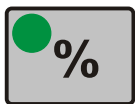

“Percent”



“Alarm”

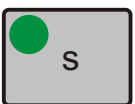

“Seconds”



“Minutes”



“Grams”

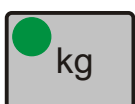

“Kilograms”



“Pound”



### 3.2. Initial operation procedure

The control system is factory-programmed. Nevertheless, specific values have to be predefined or to be checked (basic parameter setting).

The input values will be saved and will still be available after having switched off the system or a power failure.

**The following values are required (in the appendix, there is a copy of the list where the values can be entered):**

Pulses of the encoder: .....



**BISON motor (= black motor)**  
**14103 for motors with 12 rpm**  
**4387 for motors with 38 rpm**

**Bauer motor (= blue motor)**  
**11739 for motors with 6.5 rpm**  
**2135 for motors with 35.5 rpm**  
**2100 for SDD S**

Nominal current of the motor for the dosing motor (see name plate): .....



**If the value has been exceeded, an alarm message will be sent.**

Configuration value (see Determining the Configuration Value): .....

**Only in case of mounting on a Mico mixing-hopper:**

Material contents of the mixing-hopper (g): .....



Volume mixing-hopper MN*:	5.25 l
Volume mixing-hopper MV*:	13.25 l
*measured up to the upper edge of the free material inlet (swan-neck inlet)	

**Only in case of external desired value specification:**

Min. input frequency (see Frequency Output of the Extruder): .....

or if a voltage signal is available (0 - 10 V):

$$\text{Frequency [Hz]} = \frac{\text{Input voltage [V]} \times 10000 \text{ [Hz]}}{10 \text{ [V]}}$$

or if a current signal is available (0 - 20 mA):

$$\text{Frequency [Hz]} = \frac{\text{Input current [mA]} \times 10000 \text{ [Hz]}}{20 \text{ [mA]}}$$

Span factor: .....

$$\text{Span factor [Hz / rpm]} = \frac{\Delta \text{ Frequency [Hz]}}{\Delta \text{ Rotational speed of the extruder [rpm]} \times 10}$$

**Only in case of connection to a HOST:**

Communication address: .....



If there is no external desired value specification and/or connection to a host, use the values for the standard regulation.

**Determining the Configuration Value**

Mark the functions required. Move the numerical value to the empty field. Add the values at the bottom for use in basic parameter setting.



After Sterling consultation additional configurations will be possible for special applications.

















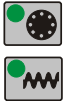
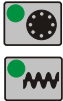
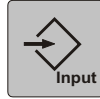



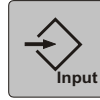
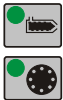

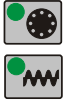

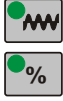

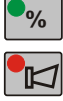
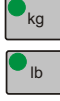
- raw material probe ..... 1 ... \_\_
  - additive probe ..... 2 ... \_\_
  - blending unit ..... 8 ... \_\_
  - throughput in lb ..... 16 ... \_\_
  - throughput g/shot (1-6500 g) (0.001-6.5 kg) ..... 0 ... \_\_
  - or**
  - throughput g/shot (1-6500 g) (0.001-6.5 kg) x factor 10 ..... 32 ... \_\_
  - or**
  - throughput g/shot (1-6500 g) (0.001-6.5 kg) x: factor 10 ..... 128 ... \_\_
  - external release starts dosing ..... 64 ... \_\_
  - mounting on a Mico mixing-hopper ..... 256 ... \_\_
  - alarm output is also switched in case of power failure ..... 512 ... \_\_
  - printer available ..... 16348 ... \_\_
- Configuration value:**..... .. \_\_

**Example:**



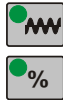





level probes: raw material probe  
 additive probe  
 throughput: 10 through 65 kg/shot  
 throughput: displayed in lb (kg)

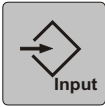
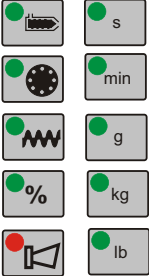

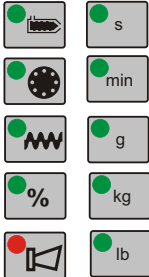
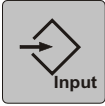



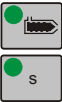
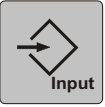
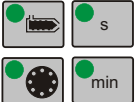

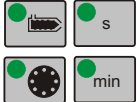

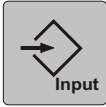
- raw material probe ..... 1 ... 1
- additive probe ..... 2 ... 2
- blending unit ..... 8 ...
- throughput in lb (kg) ..... 16 ... 16
- throughput g/shot (1-6500 g) (0.001-6.5 kg) ..... 0 ...
- or**
- throughput g/shot (1-6500 g) (0.001-6.5 kg) x factor 10 ..... 32 ... 32
- or**
- throughput g/shot (1-6500 g) (0.001-6.5 kg) : factor 10 ..... 128 ...
- external release starts dosing ..... 64 ...
- mounting on a Mico mixing-hopper ..... 256 .....
- alarm output is also switched in case of power failure ..... 512 .....
- printer available ..... 16348 .....
  
- Configuration value:** .....     51

### 3.3. Basic Parameter Setting

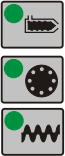
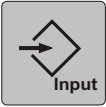
Press key	LED display	display
 	 	<p>"7"</p> <p>pulses of the encoder regulation:            14103 (12 rpm), 4387 (38 rpm),-black motor            11739 (6.5 rpm), 2135 (35.5 rpm)-blue motor            or 2100 (SDD S) respectively</p>
 	 	<p>enter the impulses of the encoder</p>
		<p>"8"</p> <p>nominal current of the motor            Bauer motor: 0.7 A - blue motor            Bison motor: 0.5 A - black motor            SDD S: 0.5 A</p>
 		<p>enter the nominal current of the motor</p>
	       	<p>"9"</p> <p>configuration value            see list "Determining the Configuration Value"</p>
 	       	<p>enter configuration value</p>

SM1-671

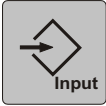
Press key	LED display	display
		<p>"10" configuration value: 1, if Bauer motor present</p>
 		<p>enter configuration value</p>
		<p>"11" minimum input frequency or number of machine cycles per dosing standard regulation: 50 Hz Only injection molding operation after contact with Sterling Service</p>
 		<p>enter input frequency / number of machine cycles</p>
		<p>"12" span factor standard regulation: 5.56 rpm/Hz</p>
 		<p>enter span factor</p>

Press key	LED display	display
		"13" communication address standard regulation: 1 Only if Euromap17-report is in use
 		enter communication address
		"14" material contents of the mixing hopper, standard regulation: 5000 g (5 kg) Only in case of mounting on a Mico mixing-hopper
 		enter material contents
		pulses of the encoder regulation
		or
		quit the menu at any time while taking on the entered values

### 3.4. Calibration



The calibration procedure has to be re-determined for each material to be metered since the calibration weight differs from material to material.



Calibration weight  
metered material weight for one revolution of the dosing disc

The following is required:

- a scale which permits weighing to at least the nearest 0.01 g (0.00001 kg)
- the weighing container which is part of the delivery

Fill the feed station with sufficient material.

#### 3.4.1. Preparations



The device may only be started up if all components have been properly installed. Danger: Limbs may be caught in machinery!

#### Feed Station with Intermediate Piece for Proportioning

Remove the blind lid at the intermediate piece for proportioning.

Slide the weighing container in the intermediate piece for proportioning.



### Standard Feed Station

Open the safety screws at the toggle-type fastener.

Open the two toggle-type fastener at the dosing motor.

Lift the feed station from the dosing motor and turn the feed station (180°) so that the output points away from the mixing hopper.

Put the feed station back on the dosing motor.

Place the weighing container under the outlet opening/outlet flange of the feed station.



Close the toggle-type fasteners.

Mount the safety screws.

### SDD 1 SGM S feed station



The device may only be started up if all components have been properly installed. Danger: Limbs may be caught in machinery!

Turn the feed station approx. 45° clockwise.

Lift the feed station from the dosing motor and turn the feed station so that the output of the dosing disc points away from the diving hose in the hopper piece.

Put the feed station back on the dosing motor (pay attention to the guide pins).

Press the feed station on the dosing motor and turn the feed station approx. 45° counter-clockwise.

### 3.4.2. Determining the Calibration Weight



Before the actual weighing, a filling process takes place which is not taken into account.

It is recommended to carry out at least five weighing procedures.

Weigh the empty weighing container and note the weight (= tare weight).

















#### **“Proportioning”**

Remove the weighing container.

Weigh the weighing container.

Subtract the tare weight of the weighing container from the determined value.

Slide the weighing container back in the intermediate piece for proportioning  
or  
place the weighing container under the outlet opening/outlet flange of the feed station.

Press key	LED display	display
		-----
		filling procedure
		<b>If calibration weight "0" in the recipe:</b> The dosing motor turns for one revolution at half of the maximum rotational speed.
 		"proportioning" and entry of the weight
		start proportioning procedure: The dosing motor turns for one revolution at the calculated speed.
 		"proportioning" and entry of the weight.
		repeat proportioning, maximum of five proportioning procedures.
		or
		terminate proportioning <b>while not taking</b> on the calibration weight
		or
		terminate proportioning <b>while taking</b> on the calibration weight

### 3.4.3. Preparing the Feed Station for Normal Operation



The device may only be started up if all components have been properly installed. Danger: Limbs may be caught in machinery!

#### Standard Feed Station

Open the safety screws at the toggle-type fastener.

Open the two toggle-type fastener at the dosing motor.

Lift the feed station from the dosing motor and turn the feed station (180°) so that the output points away from the mixing hopper.

Put the feed station back on the dosing motor.



Close the toggle-type fasteners.

Mount the safety screws.

#### Feed Station with Intermediate Piece for Proportioning

Remove the weighing container.

Mount the blind lid at the intermediate piece for proportioning.

#### Colorblend S feed station



The device may only be started up if all components have been properly installed. Danger: Limbs may be caught in machinery!

Turn the feed station approx. 45° clockwise.

Lift the feed station from the dosing motor and turn the feed station so that the output of the dosing disc is located over the diving hose in the hopper piece.

Put the feed station back on the dosing motor (pay attention to the guide pins).

Press the feed station on the dosing motor and turn the feed station approx. 45° counter-clockwise.

### 3.5. Modify/Create Recipe



By pressing the “stop” key, you can quit the menu at any time while taking on the entered values.











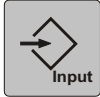



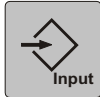

The following is required:

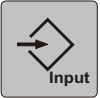



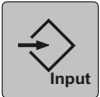
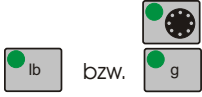



- the desired colouring (%)
- the shot weight (g, optionally: lb)
- the screw retract time/plastification time of the processing machine (s)
- the calibration weight (g, optionally: lb)

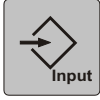



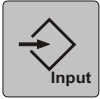

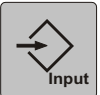

In case the steps described in the chapter “Determining the Calibration Weight” have been carried out just before, the determined value is displayed.

- the maintained running time of the blending unit (s, optional if there is only one blending unit)
- a printer (optional, only if you wish to print recipe parameters)

Press key	LED display	display
		"1" parts of the additive (colouring) in %
 		enter parts of the additive
		"2" shot weight in g or lb respectively
 		enter shot weight
		"3" plastification time of the machine in seconds
 		enter plastification time
		"4" calibration weight in g or lb respectively, <b>if "0"</b> : Set to value indicated in section 4.7, then carry out calibration.
 		enter calibration weight

Press key	LED display	display
		"5" maintained running time of the blending unit in seconds
 		enter maintained running time of the blending unit
		"6" printer Only if a printer (optional) is available
 		enter printer parameters 0 = no printing 1 = printing setpoints 2 = printing parameters 3 = page change 4 = printing each event 5 = printing alarms
		total throughput in kg (lbs.)

### 3.5.1. Save Recipe

Press key	LED display	display
		"L (= load)" and the most recently called up recipe number
		"S (= save)" and the most recently saved recipe number
 		select recipe number (1 - 10)
 > 2s	 bzw. 	save recipe



If you want to save the recipe under a number that already exists, the recipe stored under that number will be overwritten.



### 3.6. Starting mode









Only in case of mounting on a Mico mixing-hopper.

Press key	LED display	display
	$> 2s$	
	bzw.	
		total throughput

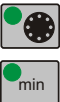

### 3.7. Starting the Continuous Operation

Press key	LED display	display
	bzw.	
		totalizer

### 3.8. Viewing the Actual Values

Press key	LED display	display
 > 2s		totalizer
		throughput
		rotational speed of the dosing motor
		nominal current of the motor in %









### 3.9. Stopping the Continuous Operation

Press key	LED display	display
		totalizer





If the "stop" key is pressed for more than 2 seconds, the weights are reset to zero.

### 3.10. Calling up the recipe

Press key	LED display	display
	 lb bzw.  kg	totalizer
		“L (= load)” and the most recently called up recipe number
 		select recipe number (1 - 10)
 > 2s	 lb bzw.  kg	call up recipe

### 3.11. Switching off the Device

Press key	LED display	display
	 lb bzw.  kg	totalizer

Switch off the device by pressing the On/Off switch.

### 3.12. Alarm Messages

In case a malfunction occurs, an alarm message will be displayed.



An A and an error number will be shown in the display.

The LED "alarm" is lit up.



The control system cannot resume the operation, unless the malfunction has been remedied.

Press the "stop" key.



By means of pressing the stop key the reason for the malfunction will not be resolved.

**"A0001"**

Strap "safety switch" is missing.

Sterling Service.

**"A0002"**

The nominal current of the dosing motor (= 100 %, see name plate) is being exceeded for more than 2 seconds by 30 % or for a maximum of 0.5 seconds by 80 %.

Dosing motor defective or jammed. Check the dosing motor and exchange it if necessary.  
Check whether the dosing disc is jammed by material and remove the material if necessary.

**"A0003"**

The nominal current of the dosing motor (= 100 %, see name plate) is being exceeded for more than one minute.

Dosing motor defective or jammed. Check the dosing motor and exchange it if necessary.  
Check whether the dosing disc is jammed by material and remove the material if necessary.

**"A0004"**

Excess temperature

The temperature within the housing is > 85°C (185°F).

Check whether the cooling plate at the back of the device is sufficiently cooled down.

**"A0005"**

The encoder (pulse generator) does not emit any pulses for approx. 2 seconds.

The dosing motor does not turn. Check whether the dosing disc is jammed by material and remove the material if necessary.

Defect at the dosing motor. Check dosing motor, exchange if necessary.

Defect at the encoder. Check encoder, exchange if necessary.

**"A0006"**

For approx. 4 seconds, there is a deviation of the motor speed of more than 20 % from the nominal rotational speed.

Defect at the dosing motor. Check dosing motor, exchange if necessary.

Check whether the dosing disc is jammed by material and remove the material if necessary.

Power supply part or control out of order. Sterling Service.

**"A0007"**

Dosing motors stops or does not work.

Brake at the dosing motor out of order.

Control system out of order. Sterling Service.

**“A0008”**

The screw retract time of the processing machine is shorter than 0.1 seconds.

The unit cannot be operated in combination with this processing machine.

**“A0009”**

The calculated speed of the motor is either too high or too low.

Check basic parameter setting and recipe, modify if necessary.

**“A0010”**

The feed station is not able to meter the desired recipe.

Check basic parameter setting and recipe, modify if necessary.

**“A0011”**

The raw material probe is not covered.

Refill material.

**“A0012”**

The additive probe is not covered.

Refill material.



The dosing process will not be interrupted.

**“A0014”**

Power failure.

**“A0015”**

EEPROM data loss, EEPROM not programmed.

Sterling Service.

**“A0016”**

No communication between HOST and unit.

Check cable fittings.

Sterling Service.

## 4. Maintenance



This chapter is intended for persons with skills in electrical and mechanical areas due to their training, experience and received instructions.

Personnel using the instructions in this chapter must be instructed of the regulations for the prevention of accidents, the operating conditions and safety regulations and their implementation.

Ensure in each case that the personnel are informed.

For maintenance work taking place at heights of over approx. 6 feet (1829 mm), use only ladders or similar equipment and working platforms intended for this purpose. At greater heights, the proper equipment for protection against falling must be worn.

Use only suitable lifting gear which is in proper working order and load suspension devices with sufficient carrying capacity. Do not stand or work under suspended loads!

Ensure that the electric motors/switch cabinets are sufficiently protected against moisture.

Use only suitable workshop equipment.

Before starting maintenance work, appoint a supervisor.

Inform the responsible personnel before maintenance work on the system is started.

Never operate the equipment when partially dismantled.

All maintenance and repair work **not** described in this chapter may only be carried out by Sterling service personnel or authorized personnel (appointed by Sterling).



Disconnect the equipment from mains supply before starting maintenance procedures to ensure that it cannot be switched on unintentionally.

Depressurize all compressed air piping of the equipment before starting maintenance work.



Please observe the maintenance intervals.

Before starting maintenance work, clean the equipment of oil, fuel or lubricants.

Ensure that materials and incidentals required for operation as well as spare parts are disposed of properly and in an environmentally sound manner.

Use only original Sterling spare parts.

Keep record of all maintenance and repair procedures.



Observe that a dosing and blending unit may only be put into operation if all dosing stations and covers are in place. Danger of squeezing!



### 4.1. Maintenance intervals

Daily:	Check warning signs on equipment for good legibility and completeness
Weekly:	Check function of the on/off switch
Every 3 months:	Check scraper in dosing station DD/DT
Every 6 months:	Check all electrical and mechanical connections for tight fit  Check adjustment of the level probes (optional), see chapter "Accessories"
Annually:	Check dosing disc in dosing station DD/DT
Each time after material is changed:	Clean dosing station  Check scraper  Check dosing disc



This maintenance schedule is calculated for 3-shift operation.



The given maintenance intervals are average values.

Check whether in your individual case the maintenance intervals must be shortened.

## 4.2. Removing/replacing scraper in the SDD dosing station

### Removing the scraper

Empty the dosing station.



Switch the control unit off by means of the on/off switch.  
Disconnect from mains voltage.

Open the tightening strap (B) on the dosing hopper.

Remove the dosing hopper from the dosing unit.

Open the safety screws at the toggle-type fasteners.

Open the toggle-type fasteners on the dosing motor.

Remove the dosing unit from the dosing motor.

Remove the cover from the connecting piece (D).

Loosen the two screws (C) on the underside of the dosing unit housing (E).

Remove the scraper (A).

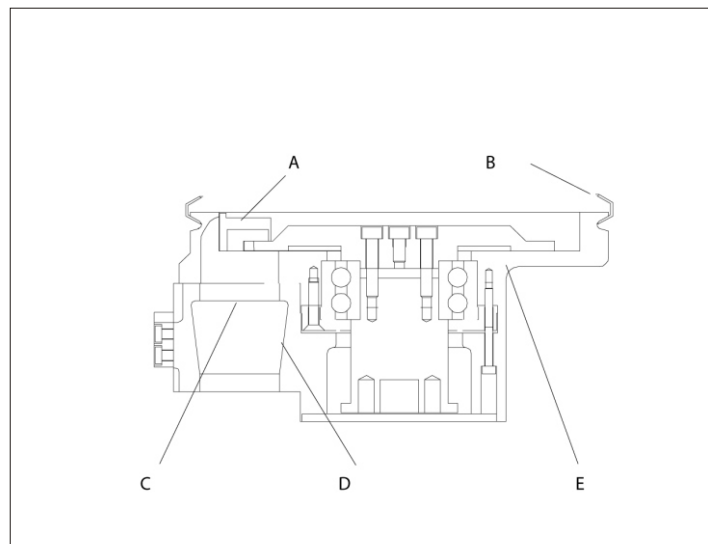

Dosing unit (side view)



When handling the scraper be careful, the scraper is sharp.  
Danger of injury exists!

**Installing the scraper**

Place the new scraper in the dosing unit housing.

Ensure that the scraper is positioned correctly.

Screw the scraper in place by means of 2 hexagon socket screws (M5 x 16).

Turn the dosing disc to check for smooth movement.

Mount the cover on the connecting piece.

Position the dosing unit on the dosing motor (note guide pins).



Close the toggle-type fasteners on the dosing motor.  
Mount the safety screws.

Position the dosing hopper on the dosing unit.



Mount the tightening strap.  
Mount the screw at the tightening strap.



Observe that a dosing and blending unit may only be put into operation if all dosing stations and covers are in place. Danger of squeezing!



Order number scraper: ID 21392

### 4.3. Cleaning the DD dosing station

#### Dismantling the dosing station

Empty the dosing station.



Switch the control unit off by means of the on/off switch.

Disconnect from mains voltage.

Open the tightening strap on the dosing hopper.

Remove the dosing hopper from the dosing unit.

Dismantle the dosing unit and remove the scraper (D).

Loosen the two hexagon socket screws (B, M6 x 30) on the top side of the dosing disc (A).

Loosen the center hexagon socket screw (C, M6 x 12) and replace by an M6 x 60 screw.

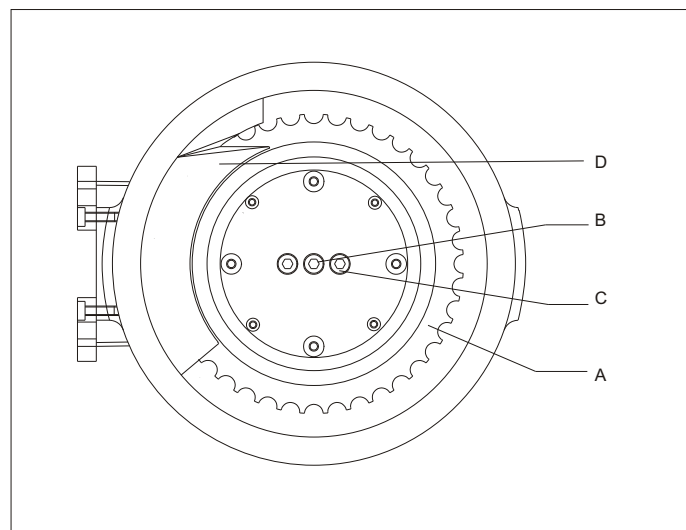

Dosing unit (top view)

Lift the dosing disc (A) from the dosing unit housing (B) by this screw.

Clean the scraper using a cotton cloth.

Clean the dosing hopper and the dosing disc in soapy water.

The dosing unit housing may also be cleaned with soapy water.

Ensure that soapy water does not enter the ball bearings.

Dry all parts thoroughly.

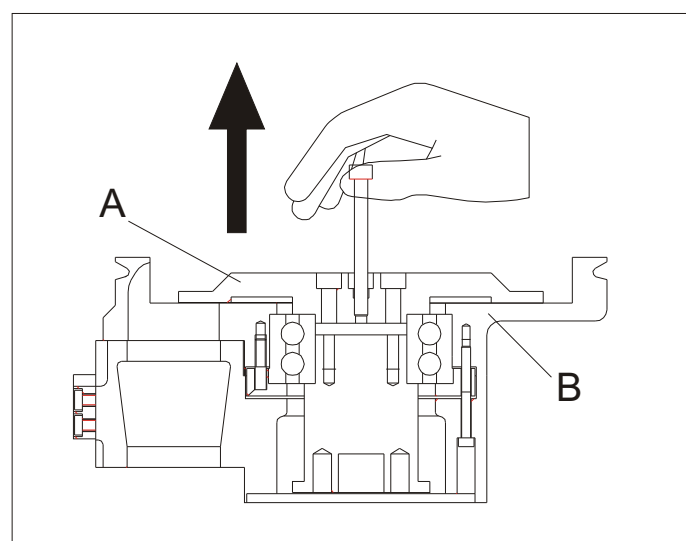

Dosing unit (side view)

**Installing the dosing station**

Place the dosing disc in the dosing unit housing.

Remove the screw (M6 x 60).

Screw the dosing disc in place by means of 2 hexagon socket screws (M6 x 30).

Mount the center hexagon socket screw (M6 x 12).

Install the scraper and then the dosing unit.

Turn the dosing disc to check for smooth movement.

Position the dosing hopper on the dosing unit.

Tighten the tightening strap.



Observe that a dosing and blending unit may only be put into operation if all dosing stations and covers are in place. Danger of squeezing!

## 4.4. Changing the dosing disc in the SDD dosing station

### Removing the dosing disc

Empty the dosing station.



Switch the control unit off by means of the on/off switch.  
Disconnect from mains voltage.

Open the tightening strap on the dosing hopper.

Remove the dosing hopper from the dosing unit.

Dismantle the dosing unit and remove the scraper.

Loosen the two hexagon socket screws (M6 x 30) on the top side of the dosing disc.

Loosen the center hexagon socket screw (M6 x 12) and replace by an M6 x 60 screw.

Lift the dosing disc from the dosing unit housing by this screw.

### Installating the dosing disc

Change and place the dosing disc in the dosing unit housing.

Remove the screw (M6 x 60).

Screw the dosing disc in place by means of 2 hexagon socket screws (M6 x 30).

Mount the center hexagon socket screw (M6 x 12).

Install the scraper and then the dosing unit.

Turn the dosing disc to check for smooth movement.

Position the dosing hopper on the dosing unit.

Tighten the tightening strap.



Observe that a dosing and blending unit may only be put into operation if all dosing stations and covers are in place. Danger of squeezing!



Order numbers

Dosing disc

72 chambers:	ID 31447
40 chambers:	ID 21710
25 chambers:	ID 21711
18 chambers:	ID 23057

Dosing disc, wear resistant

40 chambers:	ID 28214
25 chambers:	ID 27141
18 chambers:	ID 27142

### 4.4.1. Installing Different Types of Dosing Discs

Dosing discs of the same type may be exchanged for each other without any problems.

If dosing discs with a different compartment number are installed, this has to be entered in the control system.

Enter the (preliminary) calibration value of the freshly installed dosing disc  
(\* = bulk density 550 g/l (1.21 lbs/l), \*\* = bulk density 700 g/l) (1.54 lbs/l).

Dosing disc	Preliminary calibration value
SDD30-030672	*1.5 , **2.0
SDD30-051040	*4.0 , **5.0
SDD30-051725	*7.0 , **9.0
SDD30-051818	*13.0 , **17.0

Execute “calibration” to determine the final calibration value.



When saving recipes, note the dosing disc by means of which the calibration was released.

Mind that the appropriate dosing disc has to be installed when calling up stored recipes.



#### 4.5. Removing/replacing the scraper in the SDT dosing station

Empty the dosing station.



Switch the control unit off by means of the on/off switch.  
Disconnect from mains voltage.

Open the tightening strap (C) of the dosing container.

Remove the tightening strap (C).

Remove the dosing container (B) along with the dosing hopper (A).

Loosen the 3 plastic screws on the stripper (DT-t: metal screws).

Remove the scraper and holding plate.

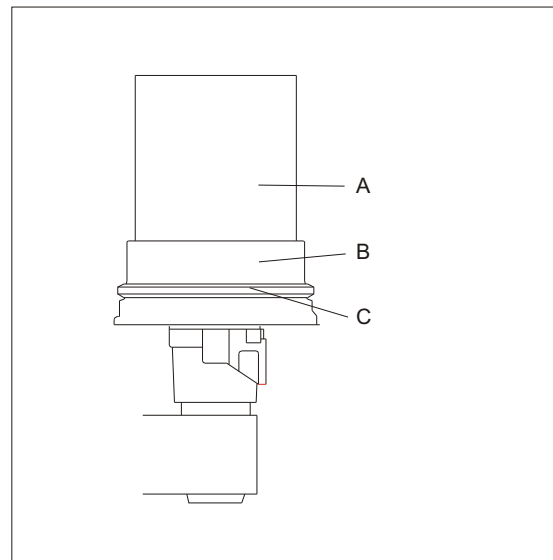

DT 30

Install the new scraper along with the holding plate.

Tighten down the 3 plastic screws. Make sure that the stripper is fitted parallel to the dosing plate.



Use only plastic screws (DT-t: metal screws).

Install the dosing container along with the dosing hopper on the dosing housing (pay attention to the guide pins).



Mount the tightening strap.

Mount the screw at the tightening strap.



Observe that a dosing and blending unit may only be put into operation if all dosing stations and covers are in place. Danger of squeezing!



Order numbers

Plastic screws:	ID 96039
Scraper:	ID 05334
Holding plate:	ID 05353

Dosing disc	
20 chambers:	ID 23056
12 chambers:	ID 23060
10 chambers:	ID 18405

## 4.6. Cleaning the SDT dosing station

Empty the dosing station.



Switch the control unit off by means of the on/off switch.  
Disconnect from mains voltage.

Open the tightening strap (C) of the dosing container.

Remove the tightening strap (C).

Remove the dosing container (B) along with the dosing hopper (A).

Open the safety screws at the toggle-type fasteners.

Open the toggle-type fasteners.

Remove the dosing housing (D) from the mixing hopper.

Clean the dosing housing (D) with a paint brush.

Clean the dosing container (B) and the dosing hopper (A) in soapy water.

Dry all parts thoroughly.

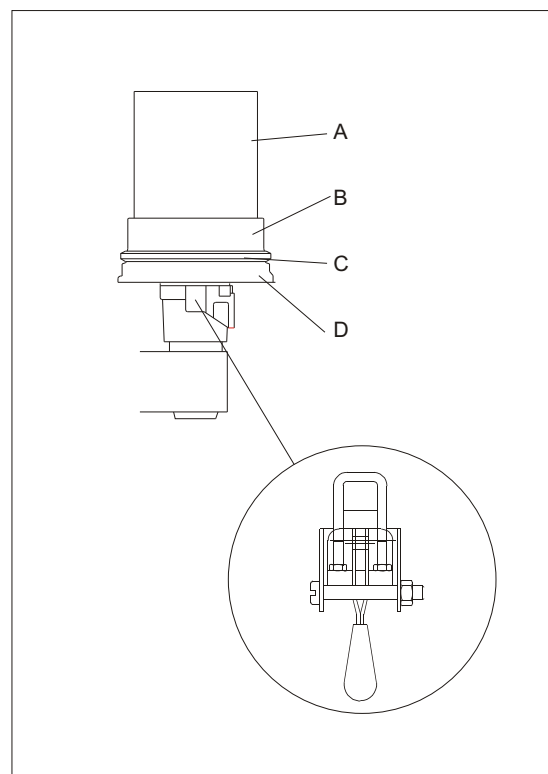

Toggle-type fastener

Mount the dosing housing onto the dosing motor.  
Observe that the guide pins are locked into position.



Close the toggle-type fasteners.  
Mount the safety screws.

Install the dosing container along with the dosing hopper on the dosing housing (pay attention to the guide pins).



Mount the tightening strap.  
Mount the screw at the tightening strap.



Observe that a dosing and blending unit may only be put into operation if all dosing stations and covers are in place. Danger of squeezing!

#### 4.7. Exchangeable stations

Dosing discs of the same type may be exchanged for each other without any problems.

If dosing discs with a different compartment number are installed, this has to be entered in the control system.

Enter the (preliminary) calibration value of the freshly installed dosing disc  
(\* = bulk density 550 g/l (35lbs/ft<sup>3</sup>), \*\* = bulk density 700 g/l) (44lbs/ft<sup>3</sup>).

Feed station	Number of dosing compartments	Preliminary calibration value
SDD30-030672	72	*1.5 , **2.0
SDD30-051040	40	*4.0 , **5.0
SDD30-051725	25	*7.0 , ** 9.0
SDD30-051818	18	*13.0 , **17.0
SDT30-101820	20	*28.0 , **35.0
SDT30-203012	12	*93.0 , **118.0
SDT30-204010	10	*148.0 , **190.0

Execute "calibration" to determine the final calibration value.



When saving recipes, note the dosing disc by means of which the calibration was realised.

Mind that the appropriate dosing disc has to be installed when calling up stored recipes.

## 4.8. Exchanging Fuses



These tasks may be carried out by trained personnel only.

Stop the continuous operation.

Wait until the dosing unit has come to a standstill.

Switch off the device by means of the On/Off switch.

Cut off the voltage supply.

Wait at least one minute before starting to work at the switching cabinet.  
Danger to life! Discharge of high-voltage possible!

Never try to repair a defective fuse.

Open the screws (A) and remove the lid (B).

Remove the blind lid (C) and open the screws.

Move the lid (D) aside.

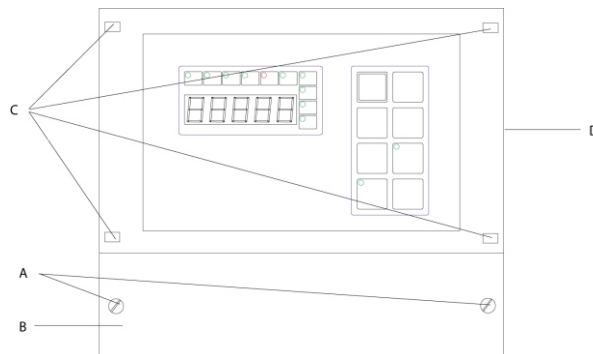

Remove the defective fuse from the fuse carrier.

Install the new fuse (while observing the value).

Mount the lid (D).

Fasten the screws and the blind lids (C).

Mount the lid (B).

Mount the screws (A).



Purchase order numbers

Fuse

F1, 5 AT: ID 84773

F2, 4 AF: ID 84770

F3, 0,5 AF: ID 83670

F4, 2 AT: ID 99815

F5, 2 AT: ID 99815

F7, 5 AT: ID 84773



## 5. Assembly instructions



These installation instructions are intended for persons with skills in electrical and mechanical areas due to their training, experience and received instructions.

Personnel using these installation instructions must be instructed in the regulations for the prevention of accidents, the operating conditions and safety regulations and their implementation.

Ensure in each case that the personnel are informed.

The installation instructions provided in the corresponding operating instructions apply for all connected equipment.

Observe all safety regulations for the operation of lifting gear.

All installation work must be carried out with the equipment disconnected from electrical power and compressed air supply.



For installation work taking place at heights of over approx. 6 feet (1829 mm), use only ladders or similar equipment and working platforms intended for this purpose. At greater heights, the proper equipment for protection against falling must be worn.

Use only suitable lifting gear which is in proper working order and load suspension devices with sufficient carrying capacity. Do not stand or work under suspended loads!

Use only suitable workshop equipment.



Install the equipment such that all parts are easily accessible; this facilitates maintenance and repair work.

### **5.1. Transport**

The equipment is delivered as a complete assembly.

Only use for transport of the equipment a suitable hoist (e. g. a fork lift truck or a workshop crane).



Please ensure adequate carrying capacity of the lifting gear.

Note that the equipment is top-heavy.

Please observe all safety regulations for the operation of lifting gear.

### **5.2. SDD 1 SGM**

SDD 1 SGM is vibration-proof. It can be mounted directly on the processing machine.

Ensure after assembly that the dosing station does not knock against other components (also when the processing machine is in operation).

### 5.2.1. Mounting on the processing machine

Remove the machine hopper from the processing machine.

Check the carrying capacity of the machine flange.



If the carrying capacity is not sufficient, a support must be mounted.

Check whether the hopper piece fits on the machine flange.

Mount the hopper piece on the processing machine if the diameter of the inlet of the machine flange is bigger than the diameter of the outlet of the hopper piece.

Observe the dimension sheet.

Mount the adapter plate or prepare an adapter plate, if the diameter of the inlet of the machine flange is smaller than the diameter of the outlet of the hopper piece.

Mount the hopper piece on the adapter plate.

Observe the dimension sheet.

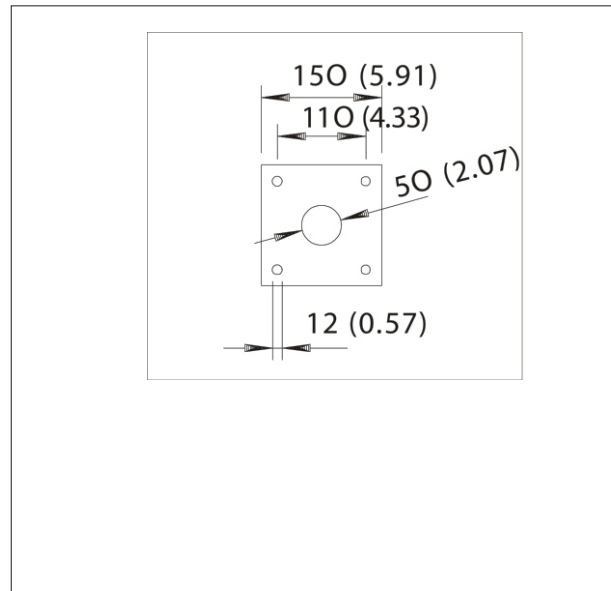

Dimension sheet (all dimensions in mm (in))



Attachments not supplied by Sterling must be manufactured in accordance with safety instruction EN 294. Caution: Danger of accidents!



The diameter of the inlet of the machine flange must be bigger than the diameter of the outlet of the hopper piece.

Ensure that all screwed connections are tight.

### 5.3. Control system S 150

The control system may be installed either directly at the hopper piece or separately (vertical installation).

The control system has to be fixed at the pre-determined fastening station.

Design an appropriate drilling jig and drill the respective holes.

Observe the indicated dimensions (see Chapter "Technical Data").

Fix the control system at the fastening stations a, b, and c:

Hang up the control system in position "a" and screw it tight in position "b" and "c".

Make sure that the cooling plate (D) is sufficiently cooled down at the back of the cooling system.

Neither expose the control system to heat (max. ambient temperature: 50°C) (122°F) nor to moisture.

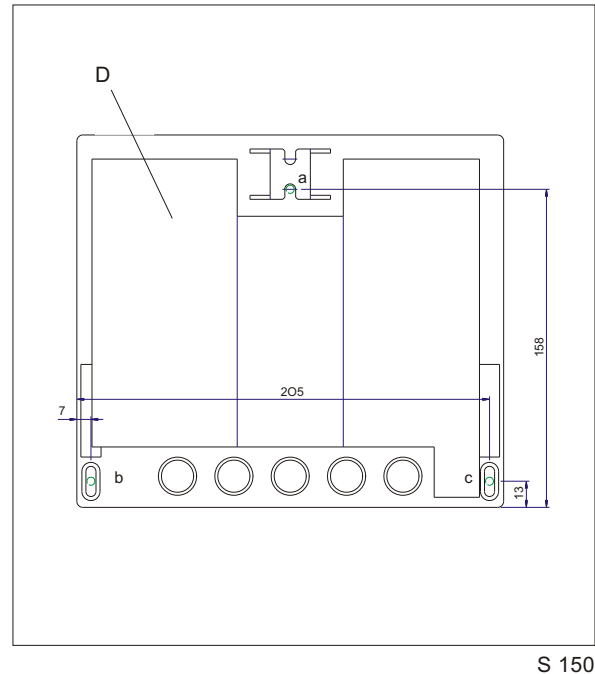

In case the temperature within the housing of the control system exceeds 85°C (185°F), the control system will be automatically switched off.

## 5.4. Electrical Connection



The electrical connection may be carried out by trained personnel only.

Other persons are not permitted to carry out the electrical connection.

The regulations of the local electricity board must be observed.

Before having the electrical connection established, please make sure that the supply voltage as well as the power frequency are identical with the data indicated on the name plate.

All work should be carried out when there is no voltage or pressure to be measured at the device.



Observe the instructions in the connection diagram.

The operating voltage amounts to 230 VAC  $\pm$  10 %, 50/60 Hz.  
Special voltages on request.

The connected load amounts to approx. 200 Watt.

## 6. Functional description



This functional description is intended for all operating personnel of the equipment.

Prerequisite for this functional description is general knowledge of dosing and blending units.

Ensure in each case that the operating personnel are sufficiently informed.

## **6.1. SDD 1 SGM**

The SDD 1 SGM is a synchronized, digital dosing system designed to precisely dose plastic additives (either in pellet or powder form) on any plastics processing machine, whether injection molding, blow molding, or all extrusion applications.

The precise dosing of additives is accomplished using a correctly sized dosing disc in combination with a special DC drive motor and our easy to operate control. This combination allows for additives to be dosed in synch with the processing machine and the flow of the main component material. When the additive and main material hit the processing screw, they will be mixed at exactly the right proportion, according to your inputted recipe. The SDD 1 SGM controllers are connected to the process machine and monitor the screw recovery time for injection, injection blowmolding and the screw speed of an extruder. Sterling guarantees delivery of a homogeneous mix every time without risk of de-mixing even with the use of micro-batch (or micro pellets).

Our design makes material changeover almost effortless. Simply lift two quick disconnects and lift off the additive station. By the use of a spare station, changeover is immediate. If you elect not to purchase a spare station, clean up and material change occurs off the machine in minutes, reducing downtime and risk of injury. Additive may also be automatically loaded by the use of one of Sterling's hopper loaders.

The SDD 1 SGM is mounted directly in the throat of the processing machine. We have various sizes and adapters to accommodate machine sizes and hopper loader configurations.

## **6.2. Control Unit S 150**

The Sterling S150 controller is a microprocessor based controller to operate the SDD 1 SGM automatic dosing station for injection molding applications.

To control the variable speed AC motors, we utilize pulse width modulation technology. This technology keeps the motor torque constant over the entire control range of operation. The drive operates with a built-in quartz cycle, digital control circuit, directly tied into the impulse speed transmitter in the dosing motor. This holds the inputted motor speed at an accuracy level of 1 minute. A sturdy key pad allows operational inputs. Operating conditions are displayed by symbols.

The additive is dosed synchronously to the main component and plasticization time of the injection molding machine. The dosing motor speed is monitored continuously and, if necessary, adjusted in a fully automatic way.

## 7. Technical Data

### 7.1. SDD 1 SGM

#### Basic Version

- Components to dose granulate, micro-batch/pellets or powder (please specify requirement)
- Quick disconnect for changeover/cleaning
- Sampling tube for simple calibration
- Ability to handle materials up to 80 °C (176 °F)
- Connection wire to processing machine
- Operating voltage either 230 +/- 10 %, AC, Single phase, 50/60Hz
- 0.2 kW operating load
- Weight 23 kg/51 lbs
- Noise level with granules/powder max. 65 dB(A) (depending on the material)
- Min. shot weight\* 5 g (0.01 lbs)
- Max. shot weight\* 6500 g (6.5 lbs.)

\*All feed rates are approximate, actual feed rates will vary according to the feed station, material, flow properties and particle size.

#### Optional Features

- Spare station for immediate changeover for pellets or powders
- Option for abrasive materials
- Hopper loaders for automatic refill
- Extern refilling systems
- Low level sensors
- Special voltage



## 7.2. Control unit S 150

### Basic equipment

- 5 digit LED display
- Memory backup for recipe and data storage
- Dry contact cycle signal input
- Input for level probe for both raw material and additives
- IP64 shielding
- short circuit proof outputs
- Operates between 0°C to +50°C (32 to 120° F)
- Storage temperature range -20 to +70° C (-4 to +160°F)
- Operating voltage 230 VAC ±10 %, 50/60 Hz
- Connected load of 100 W maximum during operation
- Dry contact alarm output
- Thermal device protection

### Optional equipment

- RS422/465 for Euromap 17 protocol interface
- Special voltage available

### Functionality

- Direct input of desired additive percentages
- Automatic calculation of calibration values for dosing
- Operating conditions shown via symbols
- Display of additive consumption
- Storage of up to 10 recipes

7.3. Dimension sheet

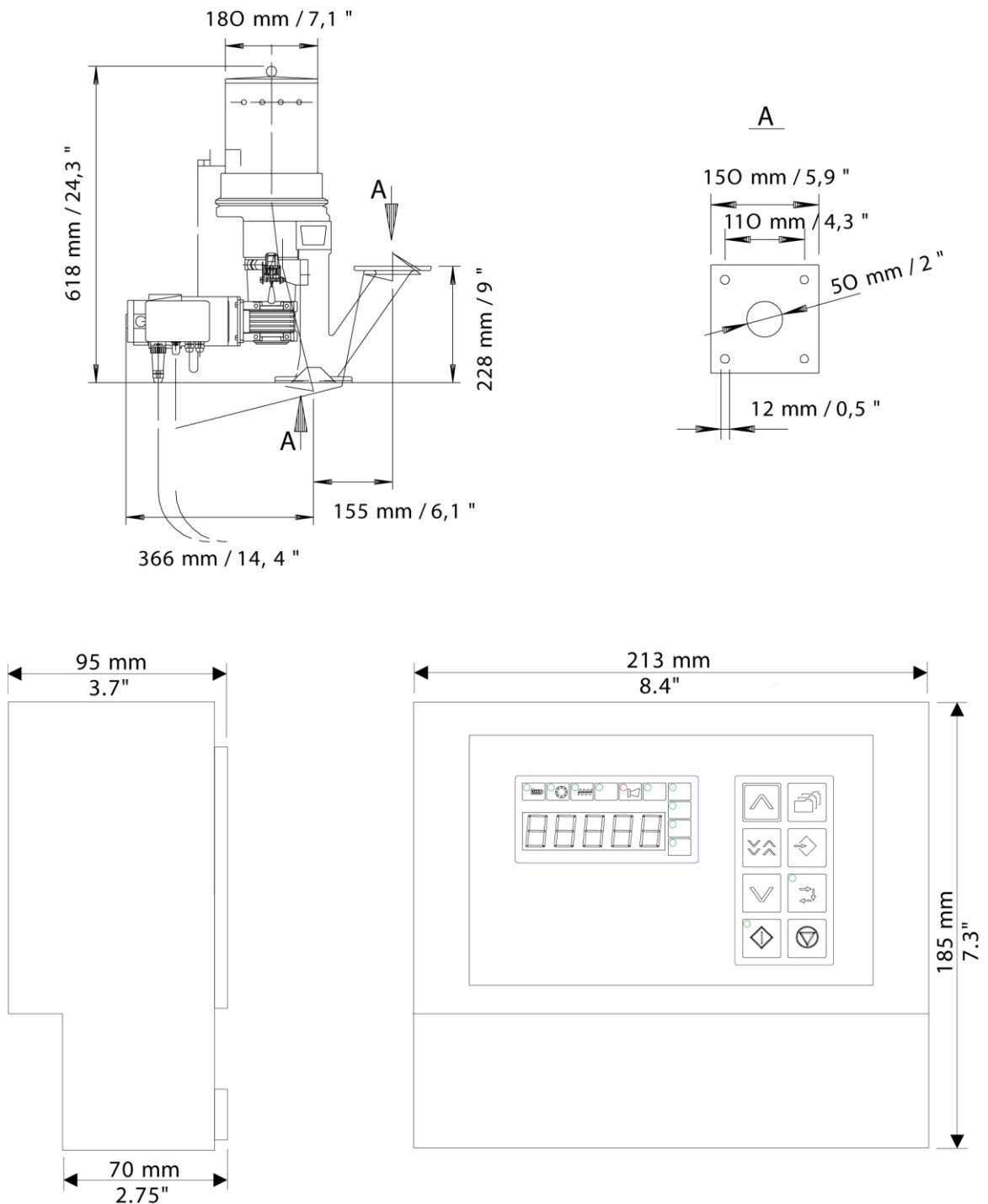

All dimensions in mm (in.). Specifications may be subject to alterations.

SM1-671

## 8. Spare parts list



This spare parts list is intended to be used only by trained personnel.  
Other persons are not permitted to modify or repair the equipment.

**Dosing station SDD**

Description	Order-Number
Scraper	21392
Dosing disc	
72 chambers:	31447
40 chambers	21710
25 chambers	21711
18 chambers	23057
Dosing disc, wear resistant	
40 chambers	28214
25 chambers	27141
18 chambers	27142

**Dosing station SDT**

Description	Order-Number
Scraper	05334
Plastic screws	96039
Holding plate	05353
Dosing disc	
20 chambers:	23056
12 chambers:	23060
10 chambers:	18405

**Control system**

Description	Order-Number
Fuse	
F1 / F7, 5 AT	84773
F2, 4 AF	84770
F3, 0,5 AF	83670
F4 / F5, 2 AT	99815

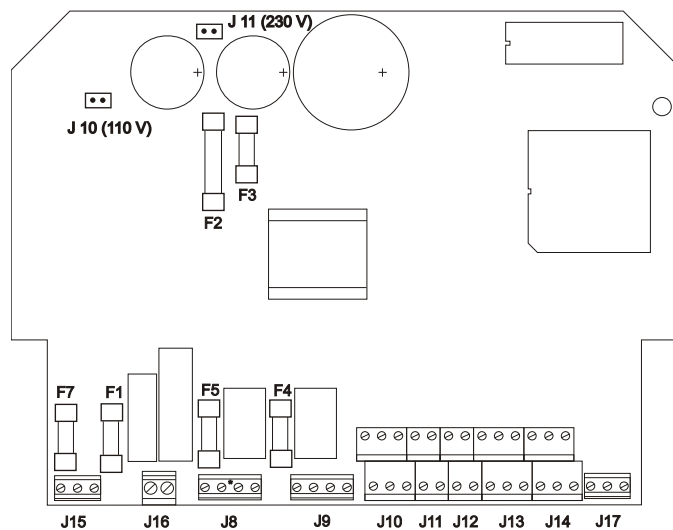

SM1-671

## 9. Accessories

- Drilling jig
- Values required for the basic parameter
- Level probe KCB-M32GP/015
- 
-

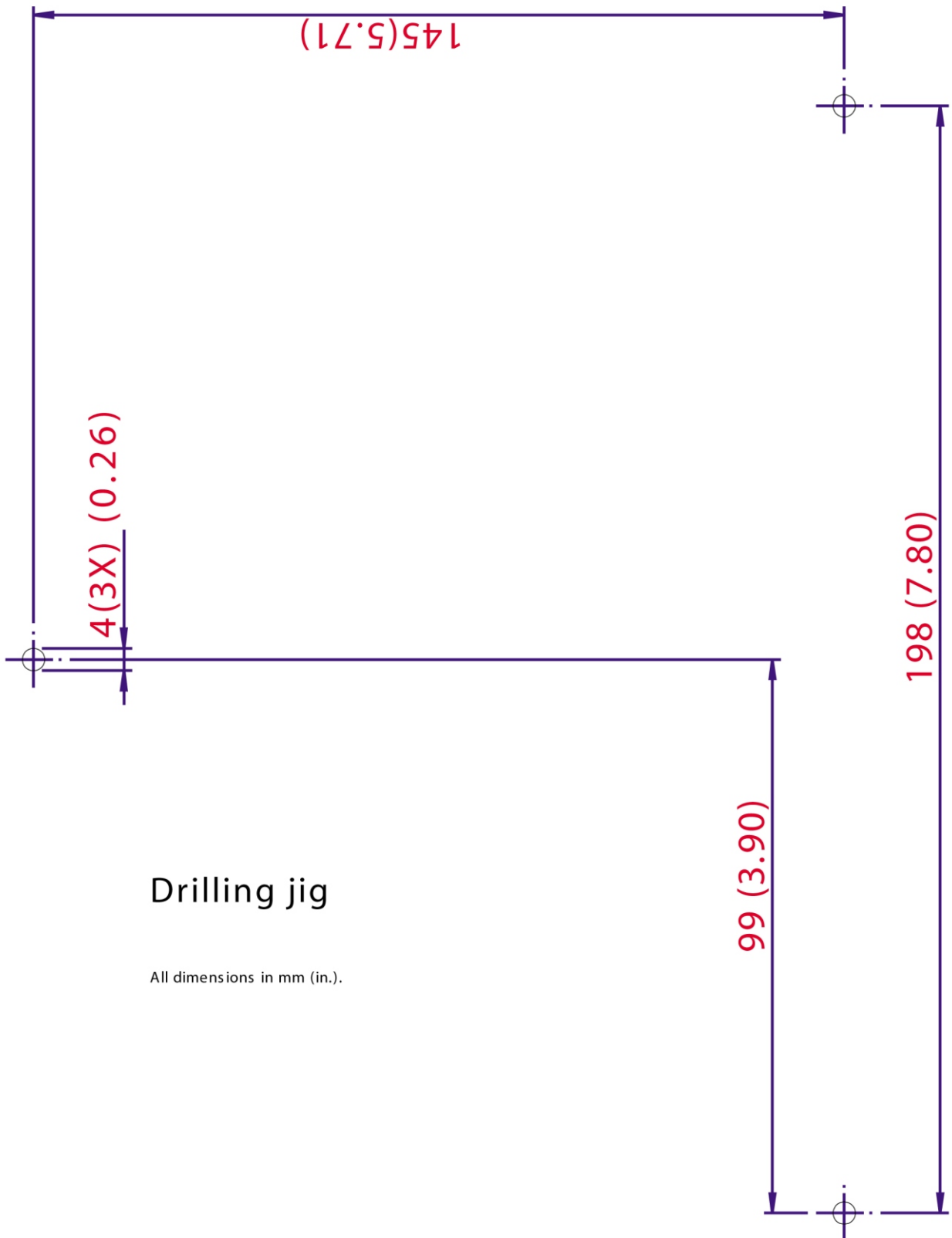

Drilling jig

All dimensions in mm (in.).

## Values required for the basic parameter:

Max. nominal current of the motor: .....

Pulses of the encoder: .....

Configuration value: .....

### In case of external desired value specification:

Min. input frequency: .....

Span factor: .....

### In case of connection to a HOST:

Communication address: .....

### In case of mounting on a Mico mixing-hopper:

Material contents of the mixing-hopper (g): .....

## **Accessories**

**Level probe  
KCB-M32GP/015**



**Adjustment of the level probes**



Do not clean the level probes before the adjustment.

Fill the dosing station until 1/3 of the level probe is covered.

Remove the plastic screw.

Turn the trim-pot until the yellow control lamp is switched off.

Don't turn further until the control lamp has switched off.

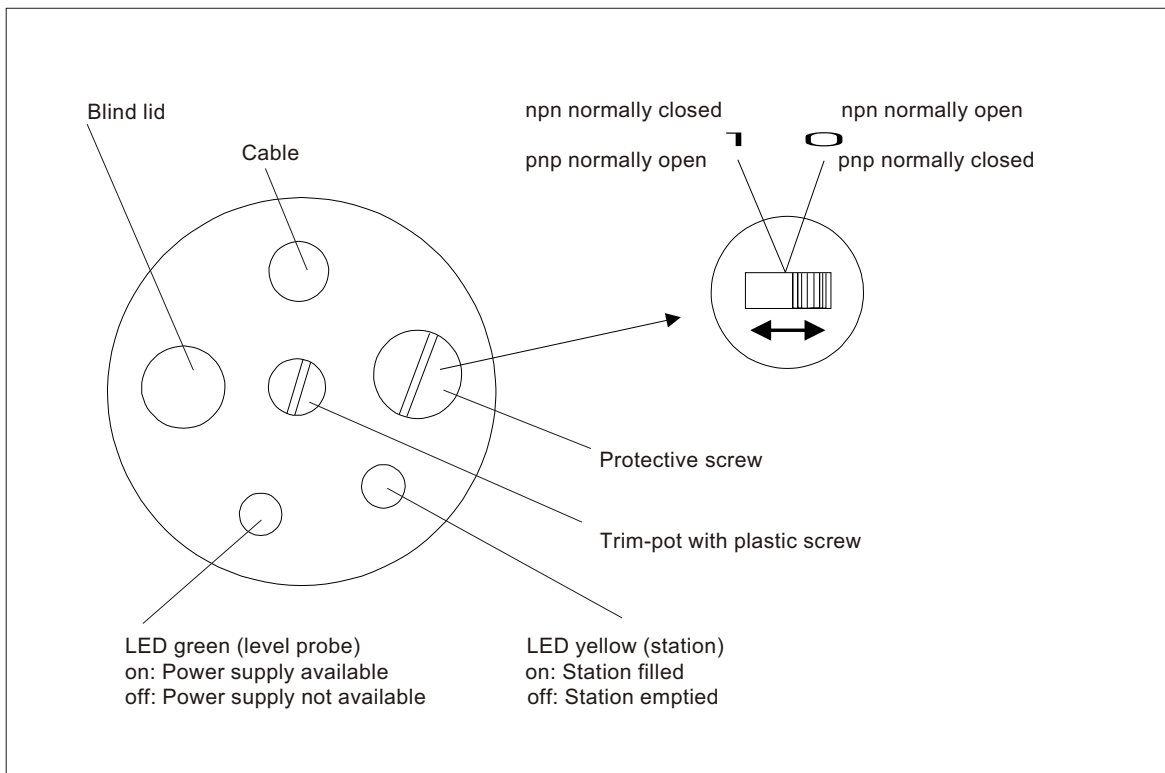

Level probe

SM1-671



Turning the trim-pot to the left decreases - turning the trim-pot to the right increases the switching-distance.

Fill the dosing station until 2/3 of the level probe is covered. The yellow control lamp must now switch on again.

Mount the plastic screw.

Check the setting during operation.



Order numbers

Level probe: ID 85871

Level probe : ID 27546  
(complete with cable)

## 10. Electrical manual



This electrical manual is exclusively determined for the use by Sterling Service personnel or by trained personnel authorised by Sterling only.

Other persons are not allowed to perform modifications or repairs on the devices.

All work should be carried out when there is no voltage to be measured at the device.

Wait at least one minute before starting to work at the switching cabinet.  
Danger to life! Discharge of high-voltage possible!

Before connection of an external power supply switch the equipment off.  
Unplug the mains plug.  
Remove the fuses F4 (= blending unit) or F5 (= alarm).



Switch off the device by means of the On/Off switch.

Cut off the voltage supply.

Wait at least one minute before starting to work at the switching cabinet.  
Danger to life! Discharge of high-voltage possible!

Loosen the screws (A) and remove the lid.

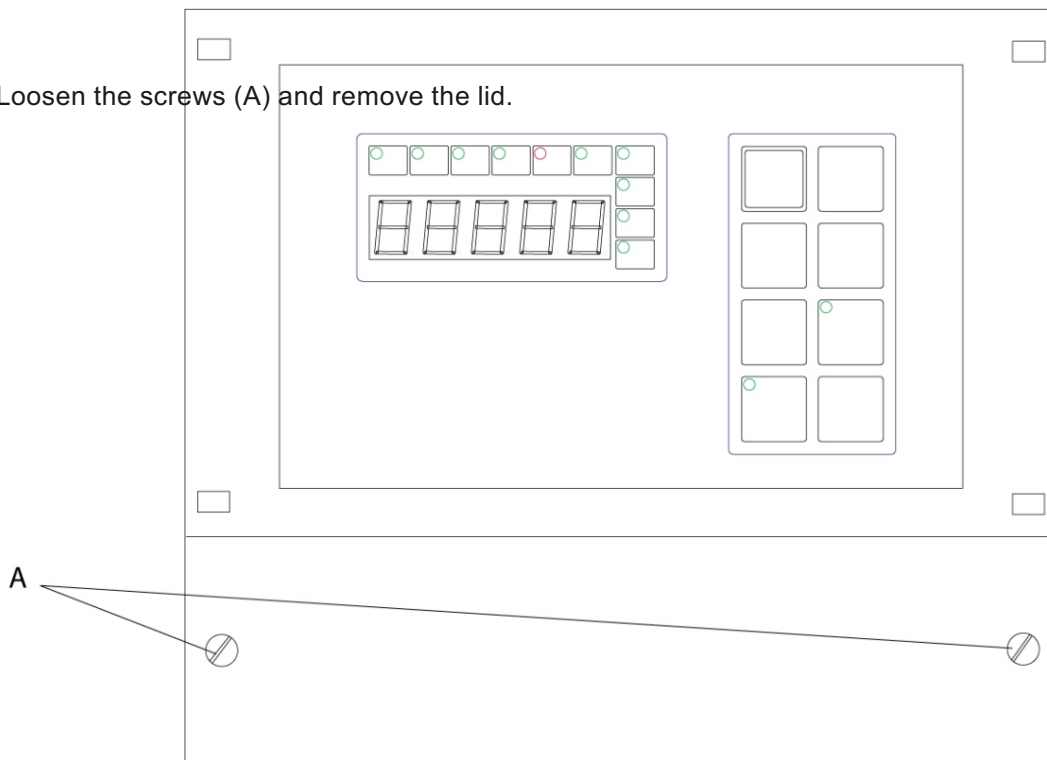

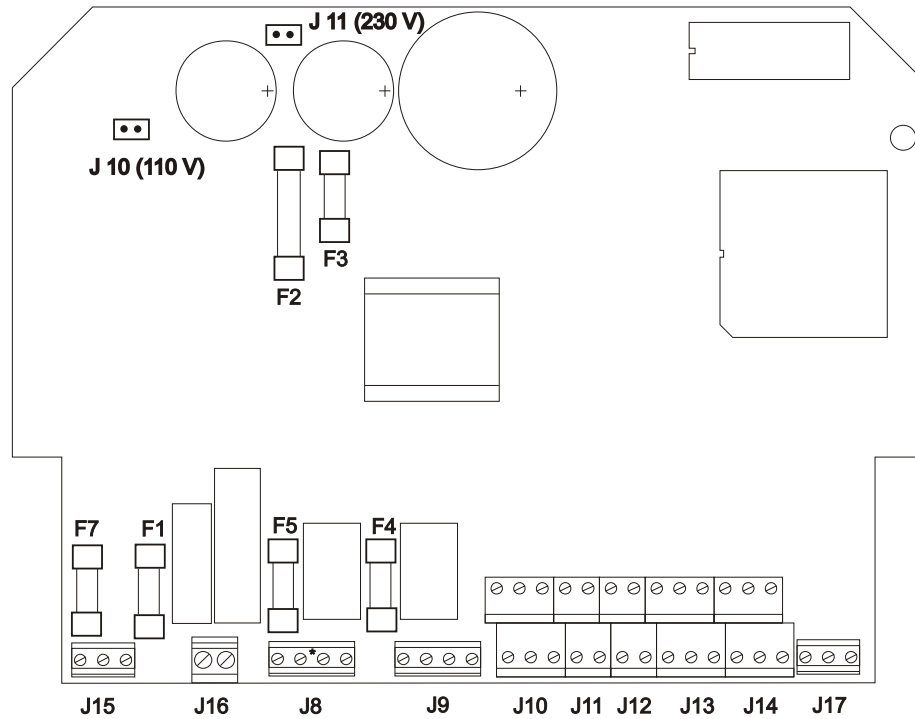

**J 15**  
Power supply

**J 16**  
1: Dosing motor -  
2: Dosing motor +

**J 8**  
1: 230 V, N  
2: PE  
3: Alarm COM  
(230 V, L1)  
4: Alarm NO

**J 9**  
1: 230 V, N  
2: PE  
3: Mixer COM  
(230 V, L1)  
4: Mixer NO

**J 10 (RS485/422)**  
1: External feed  
max. 7 V  
2: GND extern  
3: TX+  
4: TX-  
5: RX+  
6: RX-

**J 11**  
1: Start  
2: GND  
3: Alarm  
acknowledgement  
4: GND

**J 12**  
1: Reserve Input  
2: +15 V  
3: Speed Control  
4: GND

**J 13**  
1: +15 V  
2: Raw material probe  
3: GND  
4: +15 V  
5: Additive probe  
6: GND

**J 14**  
1: +15 V  
2: Rotary valve  
3: Calibration switch  
4: Tachometer-In  
5: Safety switch  
6: Tacho

**J 17**  
1: GND  
2: Tachometer-In  
3: +5 V

### Terminal Assignment S150 (115/230 V), from serial number 031.03-0108162090 onwards

From the serial number cited above onwards the blending unit and alarm relay is once again implemented as a change-over contact on the J9 or J8 terminal.

The max. terminal load consists of 230 V/2A.



**Mischer = mixer**  
**Alarm = alarm**

When the blending unit is configured (from software P2.08, E2.08 onwards):

activated J9 3-4 closed, 3-5 open,  
non-operative status: J9: 3-4 open, 3-5 closed  
(If C150 is being metered and during the run on time)

When the blending unit is not configured (from software P2.08, E2.08 onwards):

activated J9 3-4 closed, 3-5 open,  
non-operative status: J9: 3-4 open, 3-5 closed  
(When the 'RUN' key is pressed (ready for operation))

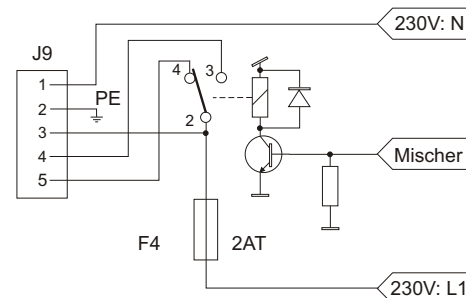

Alarm (from software P2.08, E2.08 onwards):

activated J8: 3-4 open, 3-5 closed  
If an error occurs: J8: 3-4 closed, 3-5 open

An opening function for the alarm relay can also be set in the equipment configuration:

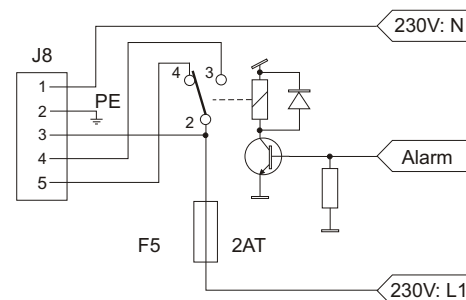

**Mark the function "alarm output is also switched in case of power failure" see page 7, chapter 3: determining the configuration value".**

Alarm (from software P2.08, E2.08 onwards):

activated J8: 3-4 closed, 3-5 open  
If an error occurs J8: 3-4 open, 3-5 closed

- Default setting:  
Injection or extrusion with external set value 0-10 kHz

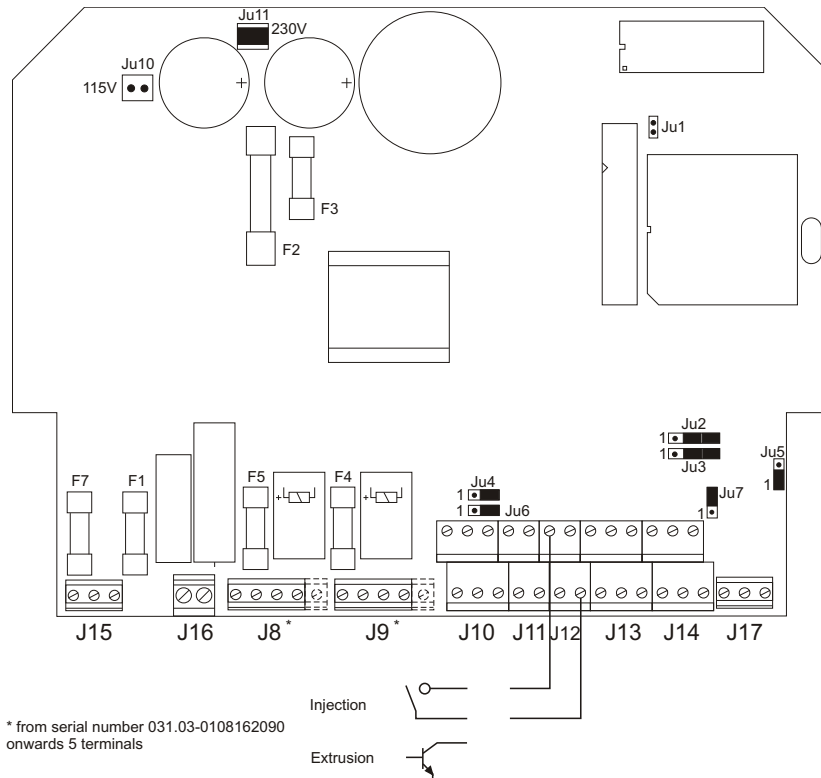

### S 150 jumper assignment

- Ju1: 1-2: Microprocessor in power save mode, open (standard)
- Ju2/3: 1-2 + 2-4: Material sensor with open collector output  
2-3 + 4-5: Material sensor with source driver (standard)
- Ju4/6: 1-2: External RS422 supply  
2-3: Internal RS422 supply (standard)
- Ju5: 1-2: Set value 0-10 kHz (standard),  
2-3: Set value 0-10 V, 0-20 mA
- Ju7: 1-2: Set value 0-20 mA,  
2-3: Set value 0-10 kHz (standard) or 0-10 V
- Ju10: Equipment supply voltage 115 V
- Ju11: Equipment supply voltage 230 V (standard)

- Extrusion with external set value 0-10 V

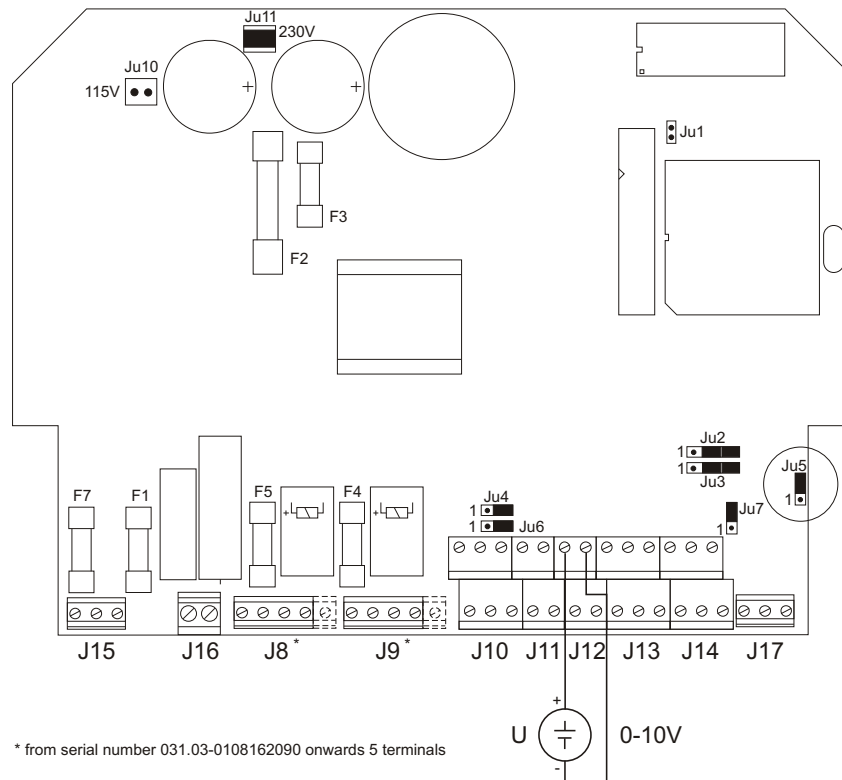

### S 150 jumper assignment

- Ju1: 1-2: Microprocessor in power save mode, open (standard)
- Ju2/3: 1-2 + 2-4: Material sensor with open collector output  
2-3 + 4-5: Material sensor with source driver (standard)
- Ju4/6: 1-2: External RS422 supply  
2-3: Internal RS422 supply (standard)
- Ju5: 1-2: Set value 0-10 kHz (standard),  
2-3: Set value 0-10 V, 0-20 mA
- Ju7: 1-2: Set value 0-20 mA,  
2-3: Set value 0-10 kHz (standard) or 0-10 V
- Ju10: Equipment supply voltage 115 V
- Ju11: Equipment supply voltage 230 V (standard)



- Extrusion with external set value 0-20 mA

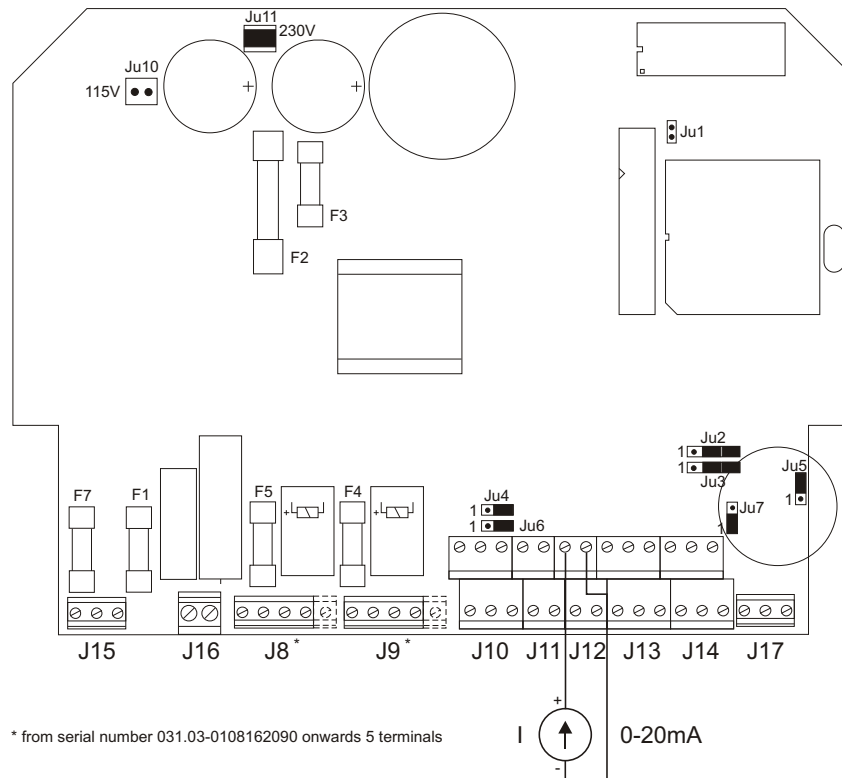

### S 150 jumper assignment

- Ju1: 1-2: Microprocessor in power save mode, open (standard)
- Ju2/3: 1-2 + 2-4: Material sensor with open collector output  
2-3 + 4-5: Material sensor with source driver (standard)
- Ju4/6: 1-2: External RS422 supply  
2-3: Internal RS422 supply (standard)
- Ju5: 1-2: Set value 0-10 kHz (standard),  
2-3: Set value 0-10 V, 0-20 mA
- Ju7: 1-2: Set value 0-20 mA,  
2-3: Set value 0-10 kHz (standard) or 0-10 V
- Ju10: Equipment supply voltage 115 V
- Ju11: Equipment supply voltage 230 V (standard)

● Connection of an alarm horn to the equipment voltage supply

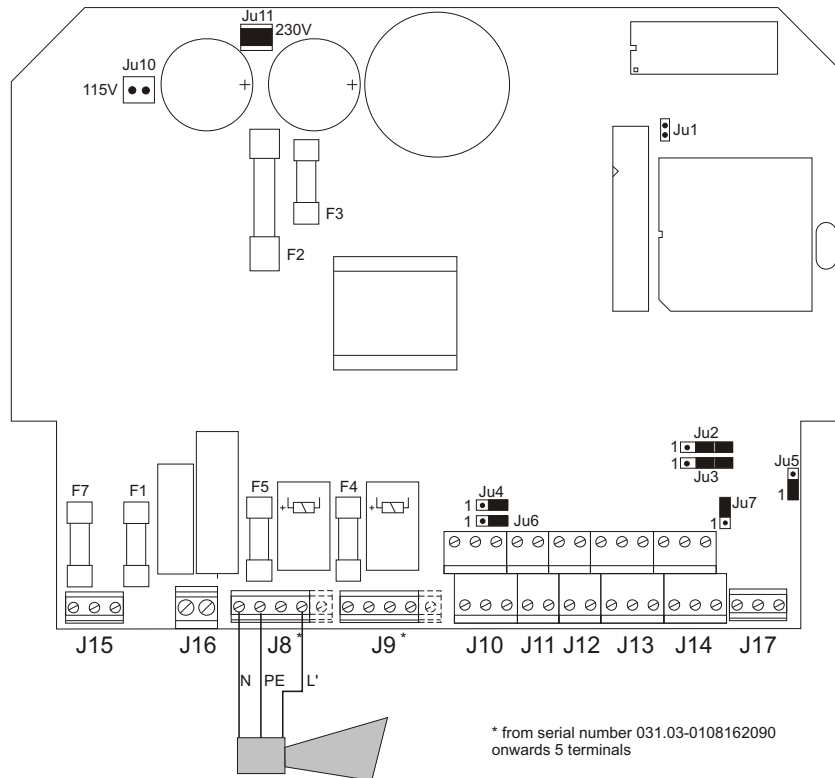

**S 150 jumper assignment**

- Ju1: 1-2: Microprocessor in power save mode, open (standard)
- Ju2/3: 1-2 + 2-4: Material sensor with open collector output  
2-3 + 4-5: Material sensor with source driver (standard)
- Ju4/6: 1-2: External RS422 supply  
2-3: Internal RS422 supply (standard)
- Ju5: 1-2: Set value 0-10 kHz (standard),  
2-3: Set value 0-10 V, 0-20 mA
- Ju7: 1-2: Set value 0-20 mA,  
2-3: Set value 0-10 kHz (standard) or 0-10 V
- Ju10: Equipment supply voltage 115 V
- Ju11: Equipment supply voltage 230 V (standard)

SM1-671

● Connection of an alarm horn to an external source of power



Before connection of an external power supply switch the equipment off.  
 Unplug the mains plug.  
 Remove the fuses F4 (= blending unit) or F5 (= alarm).

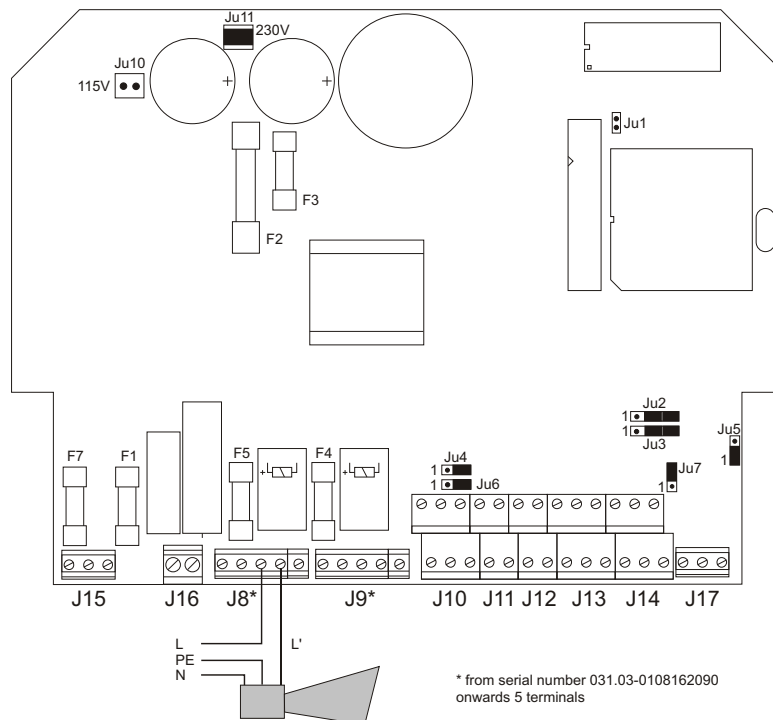

**S 150 jumper assignment**

- Ju1: 1-2: Microprocessor in power save mode, open (standard)
- Ju2/3: 1-2 + 2-4: Material sensor with open collector output  
 2-3 + 4-5: Material sensor with source driver (standard)
- Ju4/6: 1-2: External RS422 supply  
 2-3: Internal RS422 supply (standard)
- Ju5: 1-2: Set value 0-10 kHz (standard),  
 2-3: Set value 0-10 V, 0-20 mA
- Ju7: 1-2: Set value 0-20 mA,  
 2-3: Set value 0-10 kHz (standard) or 0-10 V
- Ju10: Equipment supply voltage 115 V
- Ju11: Equipment supply voltage 230 V (standard)

SM1-671

**Terminal Assignment S150 (115/230 V)**

A make contact function is available; the switchable relay output can be operated without potential or with potential.

The auxiliary voltage consists of 230 VAC.

Mixer:  
non-operative status J9: 3 - 4 open,  
in operation J9: 3 - 4 closed.

Alarm:  
non-operative status J8: 3 - 4 open,  
in operation J8: 3 - 4 closed  
(make contact).

A break contact function can also be set for the alarm relay in the device configuration.



**Mark the function “alarm output is also switched in case of power failure” see page 7, chapter 3: determining the configuration value”.**

Alarm:  
non-operative status J8: 3 - 4 closed,  
in operation J8: 3 - 4 open (break contact).



**Mixer  
Blower1 (2)  
Alarm**

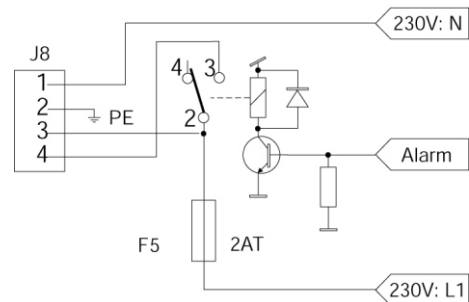
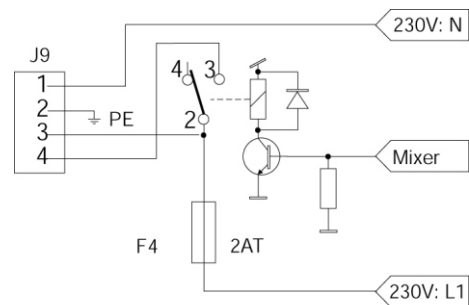

**Terminal Assignment S150  
(230 V, old version)**

Potential-free change-over contacts are available for this device generation.

Blower 1: function not used

Mixer:  
non-operative status J9: 1 - 2 closed,  
in operation J9: 2 - 3 closed.

Blower 2: function not used

Alarm:  
non-operative status J8: 6 - 5 closed,  
in operation J8: 6 - 4 closed.

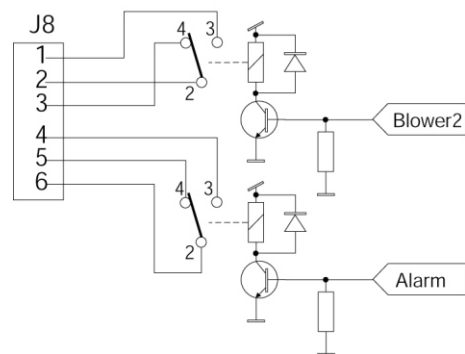
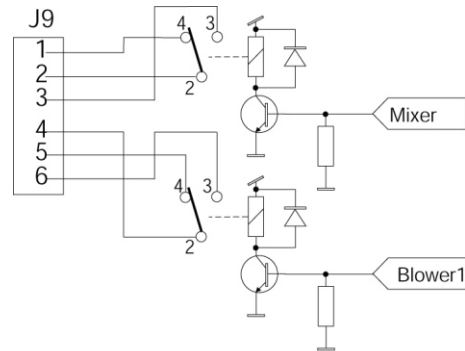

**Mixer  
Blower1 (2)  
Alarm**

## Free Manuals Download Website

<http://myh66.com>

<http://usermanuals.us>

<http://www.somanuals.com>

<http://www.4manuals.cc>

<http://www.manual-lib.com>

<http://www.404manual.com>

<http://www.luxmanual.com>

<http://aubethermostatmanual.com>

Golf course search by state

<http://golfingnear.com>

Email search by domain

<http://emailbydomain.com>

Auto manuals search

<http://auto.somanuals.com>

TV manuals search

<http://tv.somanuals.com>