

STERLING

A KOHLER COMPANY

INSTALLATION INSTRUCTIONS

SINGLE CONTROL KITCHEN FAUCET With Spray in Escutcheon

1 Before you begin

Use this diagram to familiarize yourself with the various parts of the faucet assembly. Make sure you have all the illustrated parts before you begin installation.

If you are putting in a new sink, it is easier to mount the faucet, drain and any other accessories **before** installing the sink into the countertop.

- Observe all local plumbing codes.
- Carefully inspect the valve parts for any damage.
- Flush all piping thoroughly before installing.
- Shut off hot & cold water supplies.
- Do not use plumber's putty or thread sealants on mounting nuts or coupling nuts.

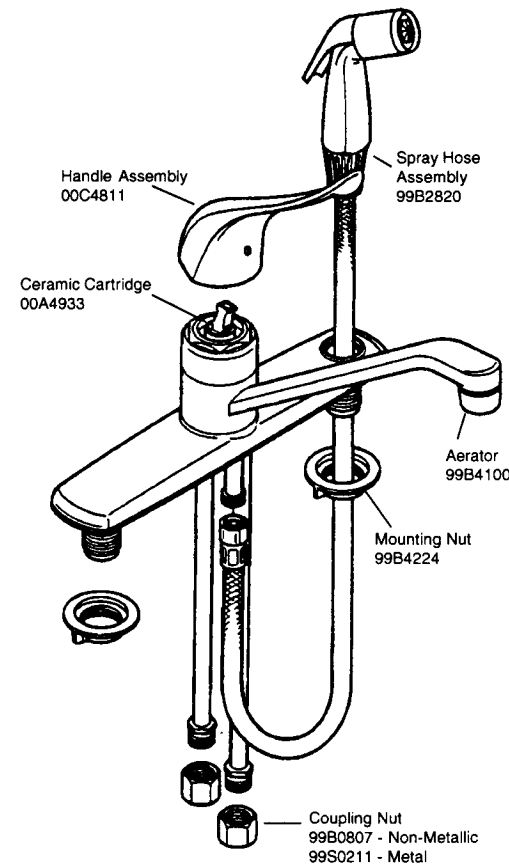

E044100

5/99

STERLING

A KOHLER COMPANY

P.O. Box 427, Oklahoma Street
Sheridan, Arkansas 72150-0427

Download from www.Somanuals.com. All Manuals Search And Download.

E044100

SINGLE CONTROL KITCHEN FAUCET

2 Items you need

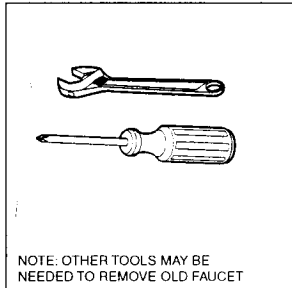

NOTE: OTHER TOOLS MAY BE NEEDED TO REMOVE OLD FAUCET

- 1 Phillips screwdriver, crescent wrench

OPTIONAL MATERIALS:

- Supply stops (2) Some installations may require stops to be installed.
- Supply tubing (2) and fittings will need to be provided.

- 2 You may need the above materials.

HELPFUL OPTION:

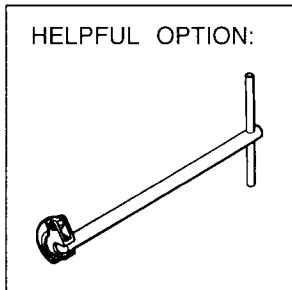

- 3 Basin wrench for removing old faucet.

3 Remove old faucet

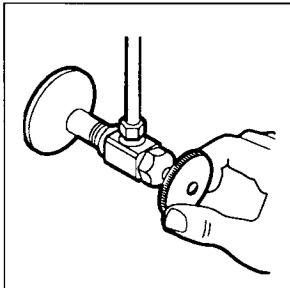

- 1 Turn off both water supplies.

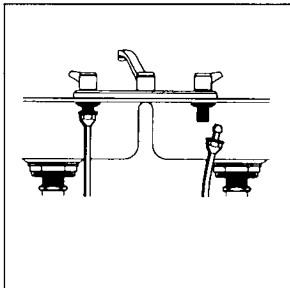

- 2 Disconnect supply lines.

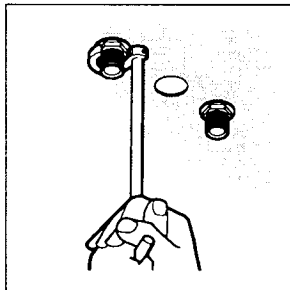

- 3 Remove mounting nuts, lift off faucet.

4 Install faucet

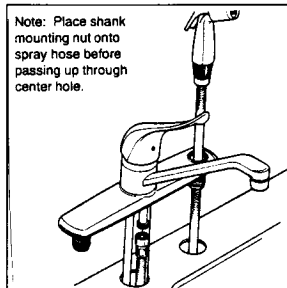

Note: Place shank mounting nut onto spray hose before passing up through center hole.

- 1 Pass spray hose down through hole in escutcheon and extreme right sink deck hole and up through center sink deck hole. Attach spray hose to spray outlet.

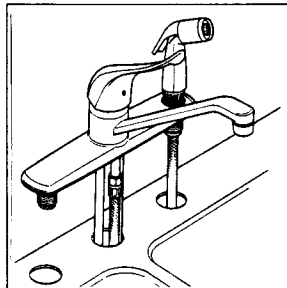

- 2 Place a bead of plumber's putty around base of faucet. Insert shanks into sink deck holes with spout to front over sink.

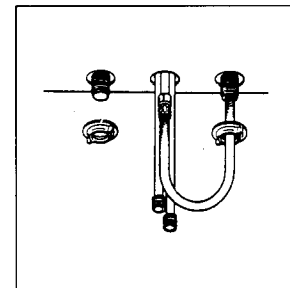

- 3 Thread mounting nuts onto shanks. FINGER tighten securely.

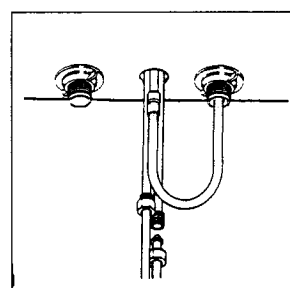

- 4 Connect hot and cold supply lines onto faucet tubes with coupling nuts. FINGER tighten securely.

5 Flush lines

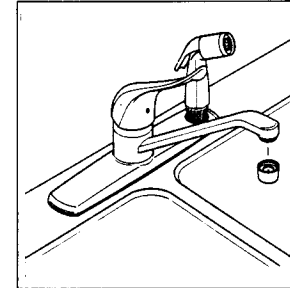

- 1 Turn on water supplies and check for leaks. With faucet off remove aerator, turn on water rotating hot through cold to flush lines and faucet. Turn faucet off and replace aerator.

6 Sterling Limited Lifetime Warranty

Sterling Plumbing Group, Inc. ("Sterling") warrants this faucet to be free of manufacturing defects and to be drip free for as long as you own your home. Damage due to improper installation, maintenance or handling are not considered manufacturing defects and are not covered by this warranty. Labor, shipping and installation costs or other charges incidental to warranty service are to be borne by the original purchaser. This warranty is valid for the original purchaser only.

Sterling will, at its election, repair or replace a faucet where Sterling's inspection discloses any such defects occurring in normal residential usage.

To obtain warranty service return the defective part(s) to your cooperating retail seller or send them to our Customer Service Department, P.O. Box 427, Sheridan, AR 72150. Refer any questions to our Customer Service Department at 1-800-245-2207.

IMPLIED WARRANTIES INCLUDING THAT OF MERCHANTABILITY AND FITNESS FOR A PARTICULAR PURPOSE ARE EXPRESSLY LIMITED TO ONE YEAR FROM DATE OF PURCHASE. STERLING DISCLAIMS ANY RESPONSIBILITY FOR SPECIAL, INCIDENTAL OR CONSEQUENTIAL DAMAGES. Some states do not allow limitations on how long an implied warranty lasts, or the exclusion or limitation of special, incidental or consequential damages, so these limitations or exclusions may not apply to you. This warranty gives you special legal rights. You may also have other rights which vary from state to state.

This is our exclusive written warranty.

For more information on Sterling Faucets, please call 1-800-STERLING.

STERLING
A KOHLER COMPANY

P.O. Box 427, Sheridan, AR 72150

Free Manuals Download Website

<http://myh66.com>

<http://usermanuals.us>

<http://www.somanuals.com>

<http://www.4manuals.cc>

<http://www.manual-lib.com>

<http://www.404manual.com>

<http://www.luxmanual.com>

<http://aubethermostatmanual.com>

Golf course search by state

<http://golfingnear.com>

Email search by domain

<http://emailbydomain.com>

Auto manuals search

<http://auto.somanuals.com>

TV manuals search

<http://tv.somanuals.com>