



## SCC 2-Pump 20-Station Controllers

Part Number: 882.00251.00  
Bulletin Number: CV3-630  
Effective: 10/25/05

Write Down Your Serial Numbers Here For Future Reference:

_____	_____
_____	_____
_____	_____

We are committed to a continuing program of product improvement.  
Specifications, appearance, and dimensions described in this manual are subject to change without notice.

DCN No. \_\_\_\_\_  
© Copyright 2005  
All rights reserved.

## Please note that our address and phone information has changed. Please reference this page for updated contact information.



These manuals are obsolete and are provided only for their technical information, data and capacities. Portions of these manuals detailing procedures or precautions in the operation, inspection, maintenance and repair of the products may be inadequate, inaccurate, and/or incomplete and shouldn't be relied upon. Please contact the ACS Group for more current information about these manuals and their warnings and precautions.

### Parts and Service Department

The ACS Customer Service Group will provide your company with genuine OEM quality parts manufactured to engineering design specifications, which will maximize your equipment's performance and efficiency. To assist in expediting your phone or fax order, please have the model and serial number of your unit when you contact us. A customer replacement parts list is included in this manual for your convenience. ACS welcomes inquiries on all your parts needs and is dedicated to providing excellent customer service.

#### For immediate assistance, please contact:

- North, Central and South America, 8am – 5pm CST +1 (800) 483-3919 for drying, conveying, heating and cooling and automation. For size reduction: +1 (800) 229-2919.  
North America, emergencies after 5pm CST (847) 439-5855  
**North America email: [acsuscanadacustserv@corpemail.com](mailto:acsuscanadacustserv@corpemail.com)**
- Mexico, Central & South America  
**Email: [acslatinamericacustserv@corpemail.com](mailto:acslatinamericacustserv@corpemail.com)**
- Europe, Middle East & Africa +48 22 390 9720  
**Email: [acseuropecustserv@corpemail.com](mailto:acseuropecustserv@corpemail.com)**
- India +91 21 35329112  
**Email: [acsindiacustserv@corpemail.com](mailto:acsindiacustserv@corpemail.com)**
- Asia/Australia +86 512 8717 1919  
**Email: [acsasiacustserv@corpemail.com](mailto:acsasiacustserv@corpemail.com)**

### Sales and Contracting Department

Our products are sold by a worldwide network of independent sales representatives. Contact our Sales Department for the name of the sales representative nearest you.

Let us install your system. The Contract Department offers any or all of these services: project planning; system packages including drawings; equipment, labor, and construction materials; and union or non-union installations.

#### For assistance with your sales or system contracting needs please Call:

North, Central and South America +1 (262) 641-8600 or +1 (847) 273-7700 Monday–Friday, 8am–5pm CST

Europe/Middle East/Africa +48 22 390 9720

India +91 21 35329112

Asia/Australia +86 512 8717 1919

#### Facilities:

ACS offers facilities around the world to service you no matter where you are located. For more information, please visit us at [www.acscorporate.com](http://www.acscorporate.com)

United States:

#### ACS Schaumburg – Corporate Offices

1100 E. Woodfield Road  
Suite 588  
Schaumburg, IL 60173  
Phone: + 1 847 273 7700  
Fax: + 1 847 273 7804

#### ACS New Berlin – Manufacturing Facility

2900 S. 160<sup>th</sup> Street  
New Berlin, WI 53151  
Phone : +1 262 641 8600  
Fax: + 1 262 641 8653

Asia/Australia:

#### ACS Suzhou

109 Xingpu Road SIP  
Suzhou, China 215126  
Phone: + 86 8717 1919  
Fax: +86 512 8717 1916

Europe/Middle East/Africa:

#### ACS Warsaw

Ul. Działkowa 115  
02-234 Warszawa  
Phone: + 48 22 390 9720  
Fax: +48 22 390 9724

India

#### ACS India

Gat No. 191/1, Sandbhor Complex  
Mhalunge, Chakan, Tal Khed,  
Dist. Pune 410501, India  
Phone: +91 21 35329112  
Fax: + 91 20 40147576

# Shipping Information

---

## ***Unpacking and Inspection***

You should inspect your equipment for possible shipping damage. Thoroughly check the equipment for any damage that might have occurred in transit, such as broken or loose wiring and components, loose hardware and mounting screws, etc.

## ***In the Event of Shipping Damage***

According to the contract terms and conditions of the Carrier, the responsibility of the Shipper ends at the time and place of shipment.

Notify the transportation company's local agent if you discover damage

Hold the damaged goods and packing material for the examining agent's inspection. **Do not return any goods before the transportation company's inspection and authorization.**

File a claim with the transportation company. Substantiate the claim by referring to the agent's report. A certified copy of our invoice is available upon request. The original Bill of Lading is attached to our original invoice. If the shipment was prepaid, write us for a receipted transportation bill.

Advise customer service regarding your wish for assistance and to obtain an RMA (return material authorization) number.

## ***If the Shipment is Not Complete***

Check the packing list as back-ordered items are noted on the packing list. In addition to the equipment itself, you should have:

- Bill of lading
- Packing list
- Operating and Installation packet
- Electrical schematic and panel layout drawings
- Component instruction manuals (if applicable)

Re-inspect the container and packing material to see if you missed any smaller items during unpacking.

## ***If the Shipment is Not Correct***

If the shipment is not what you ordered, **contact the shipping department immediately**. For shipments in the United States and Canada, call 1 (630) 595-1060; for all other countries, call our international desk at (630) 595-1060. Have the order number and item number available.

***Hold the items until you receive shipping instructions.***

## ***Returns***

Do not return any damaged or incorrect items until you receive shipping instructions from the shipping department.

### ***Credit Returns***

Prior to the return of any material, **authorization** must be given by **the manufacturer**. A RMS number will be assigned for the equipment to be returned.

Reason for requesting the return must be given.

All returned material purchased from **the manufacturer** is subject to 15% (\$75.00 minimum) restocking charge.

All returns are to be shipped prepaid.

The invoice number and date or purchase order number and date must be supplied.

No credit will be issued for material that is not within the manufacturer's warranty period and/or in new and unused condition, suitable for resale.

### ***Warranty Returns***

Prior to the return of any material, **authorization** must be given by **the manufacturer**. A RMS number will be assigned for the equipment to be returned.

Reason for requesting the return must be given.

All returns are to be shipped prepaid.

The invoice number and date or purchase order number and date must be supplied.

After inspecting the material, a replacement or credit will be given, at **the manufacturer's** discretion, if the item is found to be defective in materials or workmanship. Purchased components are covered under their specific warranty terms.

# Table of Contents

---

<b>CHAPTER 1: SAFETY .....</b>	<b>3</b>
1-1 How to Use This Manual .....	3
<i>Safety Symbols Used in this Manual</i> .....	3
<i>Controller Safety Tags</i> .....	vii
<i>Safety Circuit Standards</i> .....	vii
1-2 Warnings and Precautions .....	4
1-3 Safety Devices and Interlocks .....	6
<i>Safety Circuit Standards</i> .....	6
<i>Fail Safe Operation</i> .....	viii
<i>Safety Device Lockouts</i> .....	viii7
1-4 Responsibility .....	ix
<i>General Responsibility</i> .....	ix
<i>Operator Responsibility</i> .....	ix
<i>Maintenance Responsibility</i> .....	x
<i>Reporting a Safety Defect</i> .....	x
<b>CHAPTER 2: FUNCTIONAL DESCRIPTION.....</b>	<b>1</b>
2-1 Models Covered in This Manual .....	81
2-2 General Description.....	81
2-3 Standard Features.....	81
<i>Electrical Features</i> .....	8
<i>Controller Features</i> .....	12
2-4 Optional Features.....	92
<b>CHAPTER 3: INSTALLATION .....</b>	<b>10</b>
3-1 Uncrating .....	10
3-2 Mounting the Control Panel.....	10
3-3 Controller Identification (Serial Number) Tag .....	135
3-4 Electrical Connections .....	146
<i>Making Control Panel Power Drop Wiring Connections</i> .....	16
<i>Connecting the Control Panel to Vacuum Hoppers</i> .....	16
<i>Connecting the Control Panel to the Pump Package</i> .....	16
3-5 Setup .....	26
<i>Setting Alarm Duration</i> .....	27
<i>Setting Up Pump Staging</i> .....	28
<i>Setting Up Touch Switch Display</i> .....	20
<i>Setting Up Stations</i> .....	21
<i>Setting Up Pumps</i> .....	231
<i>Finishing Setup</i> .....	27
3-6 Initial Startup .....	268
<b>CHAPTER 4: OPERATION .....</b>	<b>30</b>
4-1 Overview .....	30
4-2 Basic Tasks .....	30
<i>Reviewing Station Status</i> .....	30
<i>Reviewing Pump Status</i> .....	31
<i>Logging On and Logging Off</i> .....	292

	<i>Enabling and Disabling Stations and Pumps</i> .....	303
	<i>Starting and Stopping the System</i> .....	313
	<i>Reviewing and Adjusting Basic Station Settings</i> .....	314
	<i>Navigating Among the Station Operator Screens</i> .....	324
	<i>Adjusting Convey Time and Dump Delay</i> .....	325
	<i>Activating and Stopping Priority Convey for a Station</i> .....	33
4-3	Adjusting Advanced Settings.....	33
	<i>Reviewing and Resetting a Pump Hour Meter</i> .....	33
	<i>Transferring Stations to a Standby Pump</i> .....	34
4-3	Alarms.....	36
	<i>Reviewing Alarms</i> .....	36
	<i>Silencing Alarms</i> .....	37

## **CHAPTER 5: RESTORING A LOST/CORRUPT PROGRAM...380**

5-1	Corrective Maintenance .....	400
	<i>PLC Memory Module</i> .....	40

## **CHAPTER 6: CONFIGURABLE SETTINGS..... 40**

6-1	Station Setup -Factory Presets .....	40
6-2	Pump Setup - Factory Presets .....	42

## **CHAPTER 7: TROUBLESHOOTING ..... 43**

7-1	General Troubleshooting.....	43
7-2	Alarms.....	44
	<i>Station Alarms</i> .....	44
	<i>Pump Alarms</i> .....	44
	<i>System Alarms</i> .....	44

## **CHAPTER 8: APPENDIX ..... 45**

8-1	Warranty.....	45
8-2	Drawings and Diagrams .....	457
8-3	Spare Parts List.....	468
	<i>AC Voltage</i> .....	468
	<i>DC Voltage</i> .....	468
8-4	Technical Assistance (Contact Information).....	49
	<i>Parts Department</i> .....	49
	<i>Service Department</i> .....	49
	<i>Sales Department</i> .....	49
	<i>Contract Department</i> .....	49

# Chapter 1: Safety

---

## 1-1 How to Use This Manual

Use this manual as a guide and reference for installing, operating, and maintaining your equipment. The purpose is to assist you in applying efficient, proven techniques that enhance equipment productivity.

This manual covers only light corrective maintenance. No other maintenance should be undertaken without first contacting a service engineer.

The Functional Description section outlines models covered, standard features, and optional features. Additional sections within the manual provide instructions for installation, pre-operational procedures, operation, preventive maintenance, and corrective maintenance.

The Installation chapter includes required data for receiving, unpacking, inspecting, and setup of the equipment. We can also provide the assistance of a factory-trained technician to help train your operator(s) for a nominal charge. This section includes instructions, checks, and adjustments that should be followed before commencing with operation of the equipment. These instructions are intended to supplement standard shop procedures performed at shift, daily, and weekly intervals.

The Operation chapter includes a description of electrical and mechanical controls, in addition to information for operating the equipment safely and efficiently.

The Maintenance chapter is intended to serve as a source of detailed assembly and disassembly instructions for those areas of the equipment requiring service. Preventive maintenance sections are included to ensure that your equipment provides excellent, long service.

The Troubleshooting chapter serves as a guide for identification of most common problems. Potential problems are listed, along with possible causes and related solutions.

The Appendix contains technical specifications, drawings, schematics, and parts lists. A spare parts list with part numbers specific to your machine is provided with your shipping paperwork package. Refer to this section for a listing of spare parts for purchase. Have your serial number and model number ready when ordering.

### **Safety Symbols Used in this Manual**

The following safety alert symbols are used to alert you to potential personal injury hazards. Obey all safety messages that follow these symbols to avoid possible injury or death.

**Danger!**      *DANGER indicates an imminently hazardous situation which, if not avoided, will result in death or serious injury.*

**Warning!**      *WARNING indicates a potentially hazardous situation or practice which, if not avoided, could result in death or serious injury.*

**Caution!**      *CAUTION indicates a potentially hazardous situation or practice which, if not avoided, may result in minor or moderate injury or in property damage.*



### Controller Safety Tags



High Voltage  
Inside Enclosure



Read Operation and  
Installation Manual

## 1-2 Warnings and Precautions

Our equipment is designed to provide safe and reliable operation when installed and operated within design specifications, following national and local safety codes. This may include, but is not limited to OSHA, NEC, CSA, SPI, and any other local, national and international regulations.

To avoid possible personal injury or equipment damage when installing, operating, or maintaining this equipment, use good judgment and follow these safe practices:

- Read and follow these operation and installation instructions when installing, operating, and maintaining this equipment. If these instructions become damaged or unreadable, additional copies are available from the manufacturer.**
- Follow all **SAFETY CODES**.
- Wear **SAFETY GLASSES** and **WORK GLOVES**.
- Work only with approved tools and devices.
- Disconnect and/or lock out power before servicing or maintaining the equipment.
- Use care when **LOADING, UNLOADING, RIGGING, or MOVING** this equipment.
- Operate this equipment within design specifications.
- OPEN, TAG, and LOCK ALL DISCONNECTS** before working on equipment. You should remove the fuses and carry them with you.
- Make sure the equipment and components are properly **GROUNDING** before you switch on power.
- When welding or brazing in or around this equipment, make sure **VENTILATION** is **ADEQUATE**. **PROTECT** adjacent materials from flame or sparks by shielding with sheet metal. An approved **FIRE EXTINGUISHER** should be close at hand and ready for use if needed.
- Do not restore power until you remove all tools, test equipment, etc., and the equipment and related components are fully reassembled.
- Only **PROPERLY TRAINED** personnel familiar with the information in this manual should work on this equipment.

We have long recognized the importance of safety and have designed and manufactured our equipment with operator safety as a prime consideration. We expect you, as a user, to abide by the foregoing recommendations in order to make operator safety a reality.

### 1-3 Safety Devices and Interlocks

This section includes information on safety devices and procedures that are inherent to the Controller. This manual is not intended to supersede or alter safety standards established by the user of this equipment. Instead, the material contained in this section is recommended to supplement these procedures in order to provide a safer working environment.

At the completion of this section, the operator and maintenance personnel will be able to do the following:

- Identify and locate specific safety devices.
- Understand the proper use of the safety devices provided.
- Describe the function of the safety device.

#### **Safety Circuit Standards**

Safety circuits used in industrial systems protect the operator and maintenance personnel from dangerous energy. They also provide a means of locking out or isolating the energy for servicing equipment.

Various agencies have contributed to the establishment of safety standards that apply to the design and manufacture of automated equipment. The Occupational Safety and Health Administration (OSHA) and the Joint Industrial Council (JIC) are just a few of the organizations that have joined with the plastics industry to develop safety standards.

Every effort has been made to incorporate these standards into the design of the conveying system; however, it is the responsibility of the personnel operating and maintaining the equipment to familiarize themselves with the safety procedures and the proper use of any safety devices.

#### **Fail Safe Operation**

If a safety device or circuit should fail, the design must be such that the failure causes a "Safe" condition. As an example, a safety switch must be a normally open switch. The switch must be held closed with the device it is to protect. If the switch fails, it will go to the open condition, tripping out the safety circuit.

At no time should the safety device fail and allow the operation to continue for example, if a safety switch is guarding a motor, and the safety switch fails, the motor should not be able to run.

#### **Safety Device Lock-Outs**

Some safety devices disconnect electrical energy from a circuit. The safety devices that are used in this Controller are primarily concerned with electrical power disconnection.

**WARNING!** *Always disconnect and lockout all electrical power and pneumatic (i.e. compressed air) sources prior to servicing the 2-Pump, 20-Station Controller. Failure to do so may result in serious injury. No one but the person who installed the lockout may remove it.*



## 1-4 Responsibility

These machines are constructed for maximum operator safety when used under standard operating conditions and when recommended instructions are followed in the maintenance and operation of the machine.

All personnel engaged in the use of the machine should become familiar with its operation as described in this manual.

Proper operation of the machine promotes safety for the operator and all workers in its vicinity.

Each individual must take responsibility for observing the prescribed safety rules as outlined. All warning and danger signs must be observed and obeyed. All actual or potential danger areas must be reported to your immediate supervisor.

### ***General Responsibility***

No matter who you are, safety is important. Owners, operators and maintenance personnel must realize that every day, safety is a vital part of their jobs.

If your main concern is loss of productivity, remember that production is always affected in a negative way following an accident. The following are some of the ways that accidents can affect your production:

- Loss of a skilled operator (temporarily or permanently)
- Breakdown of shop morale
- Costly damage to equipment
- Downtime

An effective safety program is responsible and economically sound.

Organize a safety committee or group, and hold regular meetings. Promote this group from the management level. Through this group, the safety program can be continually reviewed, maintained, and improved. Keep minutes or a record of the meetings.

Hold daily equipment inspections in addition to regular maintenance checks. You will keep your equipment safe for production and exhibit your commitment to safety.

Please read and use this manual as a guide to equipment safety. This manual contains safety warnings throughout, specific to each function and point of operation.

### ***Operator Responsibility***

The operator's responsibility does not end with efficient production. The operator usually has the most daily contact with the equipment and intimately knows its capabilities and limitations.

Plant and personnel safety is sometimes forgotten in the desire to meet incentive rates, or through a casual attitude toward machinery formed over a period of months or years. Your employer probably has established a set of safety rules in your workplace. Those rules, this manual, or any other safety information will not keep you from being injured while operating your equipment.

Learn and always use safe operation. Cooperate with co-workers to promote safe practices. Immediately report any potentially dangerous situation to your supervisor or appropriate person.

### ***Maintenance Responsibility***

Proper maintenance is essential to safety. If you are a maintenance worker, you must make safety a priority to effectively repair and maintain equipment.

Before removing, adjusting, or replacing parts on a machine, remember to turn off all electric supplies and all accessory equipment at the machine, and disconnect and lockout electrical power. Attach warning tags to the disconnect switch.

Be sure that all non-current carrying parts are correctly connected to earth ground with an electrical conductor that complies with current codes. Install in accordance with national and local codes.

When you have completed the repair or maintenance procedure, check your work, remove your tools. Rigging, and handling equipment.

### ***Reporting a Safety Defect***

If you believe that your equipment has a defect that could cause injury, you should immediately discontinue its use and inform the manufacturer.

The principle factors that can result in injury are failure to follow proper operating procedures (i.e. lockout/tagout), or failure to maintain a clean and safe working environment.

# Chapter 2: Functional Description

---

## 2-1 Models Covered in This Manual

This manual provides operation, installation, and maintenance instructions for 2-Pump, 20-Station Conveying Controllers. Model numbers are listed on the serial tag. Make sure you know the model and serial number of your equipment before contacting the manufacturer for parts or service.

The 2-Pump, 20-Station Conveying Controller is a programmable logic controller, with 24 VDC or 115 VAC control circuit, easy-to-use touchscreen operator interface terminal and optional audible/visual alarm.

## 2-2 General Description

Our material conveying systems create vacuum for the automatic conveying of most free-flowing, dry, pelletized, or granular materials. Material characteristics determine the type of equipment needed to convey the material.

A typical use for our equipment is an in-plant distribution system for plastic processing plants.

Our central vacuum systems are as varied as the applications they service. The tubing and equipment furnished in our system is designed to convey the material(s) specified at the time of purchase at specific rates and distances.

We can advise you on your system capabilities based on system makeup, distance, material, and conveying rates you want.

**System capacity is directly affected by the pressure drop in the overall system, such as number of material line bends, pipe length, Y-tubes, T-tubes, etc.**

Use the minimum effective amount of vinyl flex hose to maximize material line efficiency. Keep material lines as straight as possible. Refer to the Mechanical Components Product manual (Part No. A0536580) for installation recommendations.

## 2-3 Standard Features

### ***Mechanical Features***

**Time-fill Capability.** The time a station's vacuum valve remains open to allow material to be drawn into its receiver.

**Volume-fill Capability.** The vacuum valve will close when material covers the station's volume-fill proximity sensor or the time entered elapses, whichever comes first.

**Pump Blowback Filter Cleaning Outputs.** When this feature is enabled, the controller periodically sends air backward through the pump's air filter to dislodge accumulated dust and debris.

### ***Electrical Features***

- 115/1/60 supply voltage
- 24 V DC control voltage or 115V AC control voltage.
- Single-point power and ground connection

- Non-fused disconnect switch, lockable
- Branch circuit fusing
- Fully accessible NEMA 12-style electrical control enclosure

#### **Controller Features**

- Allen-Bradley PLC with 6” color touch screen display
- Monitors Station status and Pump status
- Allows operator to transfer stations to a standby pump when a pump fails
- Electronic time delay between pump startups to prevent an excessive power demand at your facility

## **2-4 Optional Features**

Options marked with “\*” indicate options that can be factory installed or retrofitted in the field.

**230/1/60 Operation.** Required to operate with a 230/1/60 supply voltage.

**Audible/visual alarm.** Alarm light and horn assembly that can be remote mounted and wired into the controller to indicate an alarm condition.

**CE Package for 220/1/50 Operation.** Required in Europe and other areas that need 220/1/50 supply voltage.

# Chapter 3: Installation

---

## 3-1 Uncrating

2-Pump, 20-Station Controllers are shipped mounted on a skid, enclosed in a plastic wrapper, and contained in a cardboard box.

1. Pry the crating away from the skid.

**Note:** *Remove the nails holding the box to the skid and lift the box off carefully; avoiding staples in the 1' x 4' wood supports. Cut the steel banding.*

2. Use a pry bar to remove the blocks securing the unit to the skid.
3. Lift unit from sides, inserting forklift under the base. The forks must be equidistant from the centerline of the unit and the unit must be balanced on the forks. Lift slowly and only high enough to clear the skid. Use a pry bar if necessary to carefully remove the skid from the unit.
4. Lower slowly.

## 3-2 Mounting the Control Panel

**Note:** *Before you mount the panel, consider how you will route wiring to the vacuum hoppers, the filter chamber atmospheric valve (if so equipped) and the pump motor starter(s), vacuum switch(es), and vent valve(s).*

Mount the panel on a flat, vertical area. It should be a visible area that gives your operator access to the control. The panel requires a low voltage power drop as listed on the serial tag.

**Figure 1: 2 Pump 20 Station Controller with 6" Display**

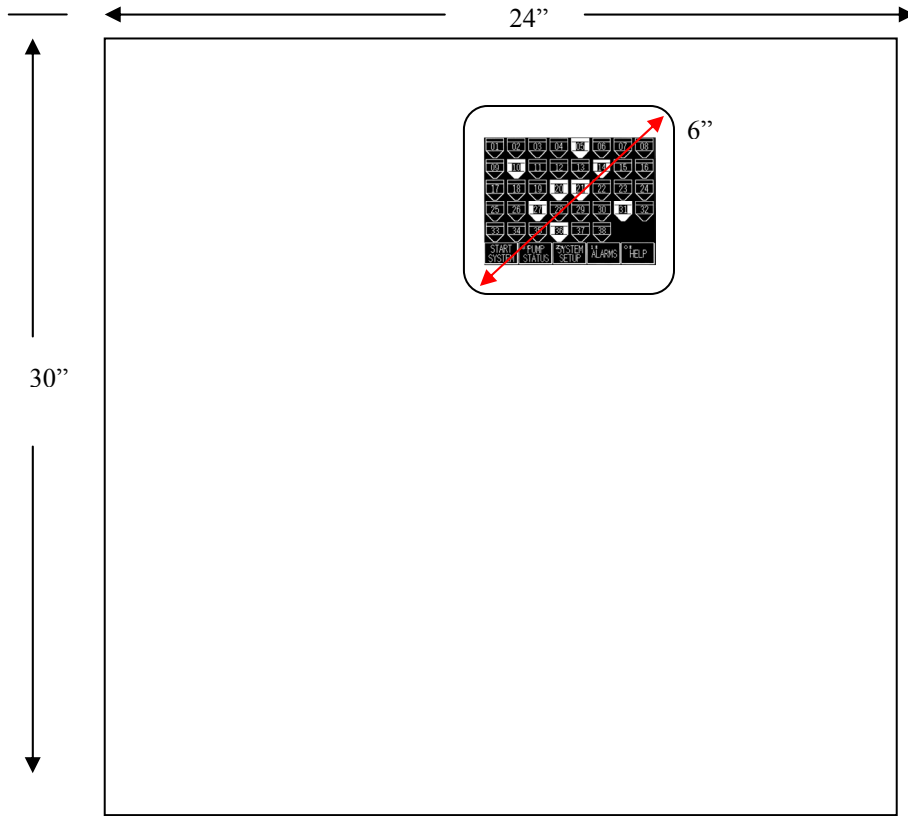

\* Depth dimension is 12"



### 3-3 Controller Identification (Serial Number) Tag

(Located on the side of the controller box)

Street Address	
Town, State, Zip Code	
Telephone Number	
Fax Number	
<hr/>	
XXX CONTROL PANEL	
Model No. XXX2-20	Serial No. 31K0182
<input type="text" value="115"/> Volt	<input type="text" value="60"/> Hz
	<input type="text" value="1"/> Ph
Control Voltage 24VDC	
<input type="text"/>	

## 3-4 Electrical Connections

Refer to local electrical codes, the schematic and connection diagrams supplied with this unit and the serial tag for wiring considerations. Run all wiring in conduit if codes require it.

### **Making Control Panel Power Drop Wiring Connections**

Hardwire the input power at 110/1/50-60 VAC or 230V/1/50-60 VAC, depending on the specifications, which are located on the Control Panel Serial Tag. The main power switch is located on the front of the enclosure.

**Caution!** *We recommend that you protect PLC memory by providing the control panel with a dedicated circuit, a true earth ground, and a spike/surge protector.*

### **Connecting the Control Panel to Vacuum Hoppers**

**Note:** *Wire size depends on control voltage, distance, number of vacuum hoppers, and the number of wires in each raceway. Consult a qualified electrician.*

1. On 115 VAC control voltage systems, run a common hot (115 VAC) wire and a common neutral wire from the controller to each vacuum hopper in the system.  
On 24 VDC control voltage systems, run a common +24 VDC wire and a common 0 (zero) VDC wire from the controller to each vacuum hopper in the system.
2. On all systems, run two wires to each vacuum hopper: one each from the controller to the Bin-Full switch (LS) and to the Atmospheric/Sequence-T solenoid (SOL) valve.
3. Make sure that the solenoid and the proximity switch (if supplied) on vacuum hoppers are the same voltage as the control panel voltage. Consult the control panel serial tag and the solenoid valve nameplates.
4. Wire size depends on control voltage, distance, number of vacuum hoppers, and the number of wires in each raceway. *Consult a qualified electrician.*
5. Properly ground each hopper to reduce static build up generated by material conveying.

### **Connecting the Control Panel to the Pump Package**

1. Wire the pump package motor starter coil (M) to the terminal provided in the control panel enclosure.
2. Wire the pump package vacuum relief valve solenoid (SOL A) to the terminal provided in the control panel enclosure.
3. Wire the pump package vacuum switch (VS) to the terminal located in the control panel enclosure.
4. On vacuum pumps, wire the pump package blowback solenoid (SOL B) to the terminal located in the control panel enclosure.

5. On 115 VAC control voltage systems, run a common hot (115 VAC) wire and a common neutral wire from the controller to each pump package in the system.

On 24 VDC control voltage systems, run a common +24 VDC wire and a common 0 (zero) VDC wire from the controller to each pump package in the system.

**Note:** Reference “Mechanical Components Operation and Installation manual” for more details on component locations (manual part # A0536580).

### 3-5 Set-up

This section provides the procedures for configuring your 2-pump, 20-station controller.

Configuration of your controller includes setting the number of stations and pumps, setting variables such as convey time and blow-back interval, and setting up passwords. We recommend that you carry out these procedures in the order given here.

**Note:** Before carrying out these procedures, install all equipment as described in this section and in the Mechanical Components manual.

#### Setting the Number of Stations and the Number of Pumps

Figure 2: Default “Station Status” Screen Before Setup



1. At the “Station Status” screen (Figure 2) or at the “Pump Status” screen, touch the **Menu** button. The “Menu” screen opens.

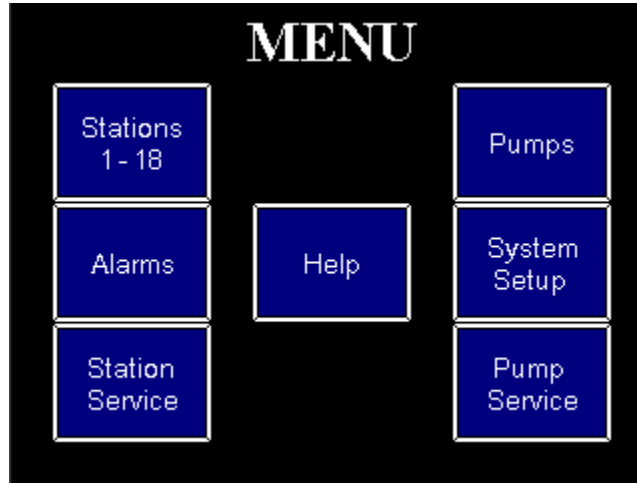

Figure 3: “Menu” Screen



- At the “Menu” screen, (Figure 3), touch the **System Setup** button. The “System Setup” screen opens.

Figure 4: “System Setup” Screen Before Setup

Strobe Suppress 0 Min	<b>System Setup</b>	Horn Silence 5 Min	Stations 1-18
Stations Present 1	Pumps Present 1	Pump Staging 5 Sec	Stations 19-20
Operator Password 0000	Operator Duration 5 Min	Button Delay 1.5 Sec	Pumps
Setup Password 0000 Min	Setup Duration 5 Min		Menu

- At the “System Setup” screen, (Figure 4), touch **Stations Present**. A keypad pops up.
- Enter the total number of stations (1-20) to be controlled by the system. Use  (Backspace Key) to erase any mistakes. Use  (Enter Key) to enter the value. The keypad disappears, and the new setting appears under **Stations Present**.
- Touch **Pumps Present**. A keypad pops up.

6. Enter the total number of pumps (1-2) to be controlled by the system. Use



(Backspace Key) to erase any mistakes. Use  (Enter Key) to enter the value. The keypad disappears, and the new setting appears under **Pumps Present**.

### Setting Up Alarm Duration

When an alarm occurs, a horn sounds and a strobe light flashes at each installed central alarm. An alarm banner screen appears. An alarm message and **Alarm Silence** button are on the banner. Touching this button silences the horn and turns off the lights for configurable periods of time and causes the alarm banner to disappear. You can set different lengths of time for keeping the horn silent and keeping the light turned off. If a new alarm occurs, the horn sounds and the light turns on again.

To set the lengths of time for suppressing the alarm strobe and horn, complete the following steps:

1. Go to the “System Setup” screen (Figure 5) by touching the **Menu** button on any screen. Then touch **System Setup**. The “System Setup” screen will pop up.
2. On the “System Setup” screen (Figure 5), touch the **Strobe Suppress** button. A keypad pops up with an entry of 0.

Figure 5: System Setup Screen

Strobe Suppress 0 min	System Setup	Horn Silence 5 Min	Stations 1-18
Stations Present 1	Pumps Present 1	Pump Staging 5 Sec	Stations 19-20
Operator Password 0000	Operator Duration 5 Min	Button Delay 1.5 Sec	Pumps
Setup Password 0000	Setup Duration 5 Min		Menu

3. Enter the number of minutes (between 0 and 99) that you want the strobe lights to stay off. If you want the light to stay on as long as the alarm persists, leave the setting at 0. If

you want the light to stay off until a new alarm occurs, enter 99 in the keypad. Use



(Backspace Key) to erase any mistakes. Use  (Enter Key) to enter the value. The keypad disappears and the new setting appears under **Strobe Suppress**.

4. On the “System Setup” screen (Figure 4), touch the **Horn Silence** button. A keypad pops up with an entry of 0.

5. Enter the number of minutes (between 0 and 99) that you want the horn to stay off. If you want the horn to stay on as long as the alarm persists, leave the setting at 0. If you

want the horn to stay off until a new alarm occurs, enter 99 in the keypad. Use 

(Backspace Key) to erase any mistakes. Use  (Enter Key) to enter the value. The keypad disappears and the new setting appears under **Horn Silence**.

### **Setting Up Pump Staging**

To avoid an excessive power demand at your facility when the conveying system starts up, you can stagger the times at which pumps start. Whenever a demand would cause two pumps to start simultaneously, your choice for pump staging sets the delay between the start of one pump and the start of the next. The factory default is a delay of three seconds. You need to change this setting only if this delay is too long or too short for your facility.

To set the delay between the start of one pump and the next, complete the following steps:

1. Go to the “System Setup” screen by touching the **Menu** button on any screen. Then touch **System Setup**. The “System Setup” screen will pop up.
2. Touch the **Pump Staging** button. A keypad pops up.
3. Enter the number of seconds (between 0 and 99) for the length of the delay between the

start of one pump and the next. Use  (Backspace Key) to erase any mistakes.

Use  (Enter Key) to enter the value. The keypad disappears, and the new setting appears under **Pump Staging**.

### **Setting Up Touch Switch Delay**

During operation, the controller normally displays the “Station Status” screen or the “Pump Status” screen, showing the current status of all stations or pumps. Briefly touching the icon for a station or pump toggles between taking it offline (disabling it) and putting it online (enabling it). Touching the icon and holding it takes the user into the controller’s menu system. The setting for button delay determines how long the user must keep an icon touched before a menu appears. The factory default is 1.5 seconds. You need to change this setting only if you find that users are having difficulty with the current setting.

To change the touch switch delay, complete the following steps:

1. Go to the “System Setup” screen by touching the **Menu** button on any screen. Then touch **System Setup**. The “System Setup” screen will pop up.
2. On the System Setup screen (Figure 4), touch the **Button Delay** button. A keypad pops up.

3. Enter the number of seconds (between 0 and 99) for the button delay. Use 

(Backspace Key) to erase any mistakes. Use  (Enter Key) to enter the value. The keypad disappears, and the new setting appears under **Button Delay**.

## Setting Up Stations

Before starting the system, you must define several settings for each station, such as which pump conveys material to it. This section first discusses how to use the controller's menu system to configure stations. The table on pages 40–41 discusses the individual choices.

### Setting Up a Single Station

1. Go to the “Station Status” screen if needed. To reach this screen from any other screen, touch **Menu** on the right hand side of the screen, and then touch **Stations**. The “Station Status” screen appears.

Figure 6: “Station Status” Screen

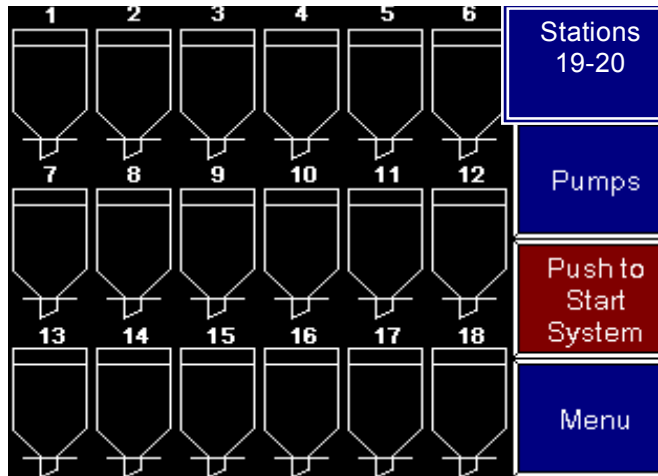

2. On the “Station Status” screen (Figure 6), touch the icon for the station you want to setup, and hold it for several seconds. The “Station Operator” screen opens.

Figure 7: “Station Operator” Screen Before Setup

Back	STATION 1 OPERATOR	Next
Convey Time 30 Secs	Last Convey 0 Secs	Stations
Dump Delay 15 Secs	Assigned To Pump 0	Station Setup
Priority Convey Activate		Menu

3. On the “Station Operator” screen (Figure 7), touch the **Station Setup** button. The “Station Setup” screen opens.

Figure 8: “Station Setup” Screen

STATION 1 SETUP			Next
Convey Time 30 Secs	Dump Delay 15 Secs	Last Convey 0 Secs	Back
Assigned To Pump 0	No Convey Disabled	3 Attempts B4 Alarm	Goto **
Special Convey Disabled	Priority Convey Activate	Reset to Defaults	Copy
			Stations
			Menu

- On the “Station Setup” screen (Figure 8), adjust settings as required. Touching any box that appears in red (for “disabled”) toggles it to green (for “enabled”), and vice versa. Touching any white box gives you a keypad to enter a new value.

Touching **Reset To Defaults** in the lower right of the screen changes all the settings for this station back to their factory defaults.

See pp. 382–42 for details on the options and their default settings.

- As appropriate, setup the rest of the stations using either of the following methods:
  - Copy this station’s settings to one or more other stations, as described below.
  - Use the **Back** or **Next** buttons to navigate to other stations. Touch **Back** to go to the previous “Station Setup” screen, or touch **Next** to go to the next “Station Setup” screen.
  - Touch **Goto** and enter a station number to go to that station’s setup screen.

#### Copying Settings from One Station to Others

If other stations at your facility will use the same settings as a station you have already set up, you can copy the settings from this station to the others. To copy settings from one station to others, complete the steps below.

- At the “Station Setup” screen (See Figure 8) for the station you want to copy *from*, touch **COPY**. The “Station Copy” screen appears, showing the station number for the station you are copying from.



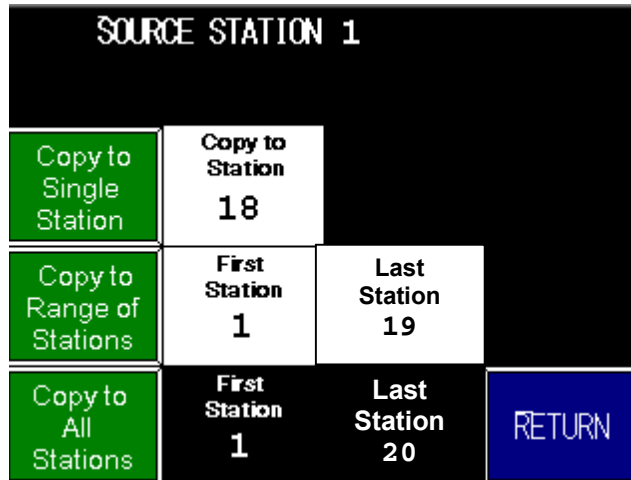

Figure 9: "Station Copy" Screen



Follow the directions below to copy settings to one other station, a range of stations, or all stations:

Copying to One Other Station:



1. On the "Station Copy" screen (Figure 8), touch the gray **Copy to Station** button. The keypad pops up.

2. Enter the station number for the station you are copying to. Use  (Backspace Key) to erase any mistakes. Use  (Enter Key) to enter the value. The keypad disappears, and the "Station Copy" screen shows the station number you entered.



3. Touch the green **Copy to Signal Station** button. **Complete** briefly appears on the screen.
4. As appropriate, either continue copying to other stations, or touch **Return** to go back to the "Station Setup" screen.

Copying to a Range of Other Stations:

1. On the "Station Copy" screen (Figure 9), touch the gray **First Station** button. The keypad pops up.

2. Enter the station number for the lower end of the range you are copying to. Use  (Backspace Key) to erase any mistakes. Use  (Enter Key) to enter the value. The keypad disappears, and the "Station Copy" screen shows the station number you entered under **First Station**.

3. On the "Station Copy" screen (Figure 9), touch the gray **Last Station** button. The keypad pops up.

4. Enter the station number for the upper end of the range you are copying to. Use  (Backspace Key) to erase any mistakes. Use  (Enter Key) to enter the

value. The keypad disappears, and the “Station Copy” screen shows the station number you entered under **Last Station**.

5. Touch the green **Copy to Range of Stations** button. **Complete** briefly appears on the screen.
6. As appropriate, either continue copying to other stations, or touch **Return** to go back to the “Station Setup” screen.

Copying to All Other Stations:

1. On the “Station Copy” screen (Figure 9), touch the green **Copy to All Stations** button. **Complete** briefly appears on the screen.
2. Touch **Return** to go back to the “Station Setup” screen.

### Setting Up Pumps

Before starting the system, you must define several settings for each pump, such as how quickly to shut it down when it is not in use. This section first discusses how to use the controller’s menu system to configure pumps. The table on page 422 discusses the individual choices.

#### Setting Up a Single Pump

1. Go to the “Pump Status” screen if needed. To reach this screen from any other screen, touch **Menu** on the right-hand side of the screen, and then touch **Pumps**. The “Pump Status” screen appears:

Figure 10: “Pump Status” Screen

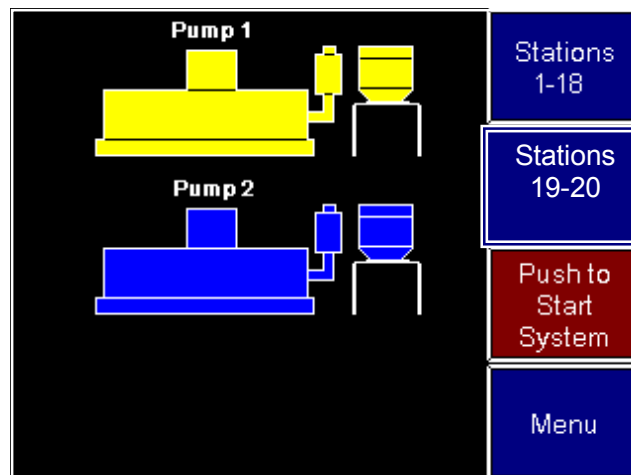

2. Touch the icon for the pump you want to set up, and hold it for several seconds. The “Pump Setup” screen opens.

Figure 11: Pump Setup Screen

Idle Time 30 Sec	<b>PUMP 1 SETUP</b>	Transfer to Standby	Next
Hour Meter Reset	0 HOURS Resettable	0 HOURS	Back
Blowback Disabled	Blowback Every 5 Loads	Blowback 5 Pulses	Goto ***
ON Time 0 . 2 Secs	OFF Time 2 . 0 Secs	Pump Fault Disabled	Copy
			Pumps
			Menu

- Adjust settings as required. Touching any box that appears in red (for “disabled”) toggles it to green (for “enabled”), and vice versa. Touching any box that appears in white gives you a keypad to enter a new value.

See page 422 for details on the options and their default settings.

- As appropriate, setup the rest of the pumps using either of the following methods:
  - Copy this pump’s settings to one or more other pumps, as described below
  - Use the **Back** or **Next** buttons to navigate to other pumps. Touch **Back** to go to the previous “Pump Setup” screen, or touch **Next** to go to the next “Pump Setup” screen.
  - Touch **Goto** and enter a pump number to go to that pump’s setup screen .

#### Copying Settings from One Pump to the Other

If another pump at your facility will use the same settings as a pump you have already set up, you can copy the settings from this pump to another. To do so:

At the “Pump Setup” screen (Figure 11) for the pump you want to copy *from*, touch **Copy** in the upper right corner. The Pump Copy screen appears, showing the pump number for the pump you are copying from.

**Figure 12: Pump Copy Screen**

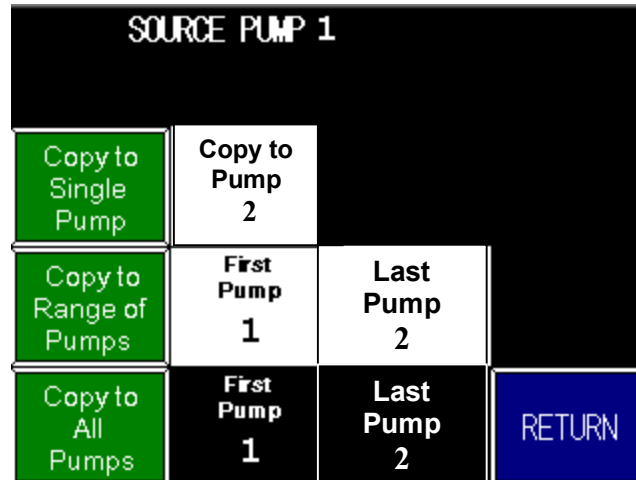

Follow the directions below to copy settings to one other station, a range of stations, or all stations:

- Copying to One Other Pump:

1. On the “Pump Copy” screen (Figure 12), touch the gray **Copy to Pump** button. The keypad pops up.





2. Enter the pump number for the station you are copying to. Use  (Backspace

Key) to erase any mistakes. Use  (Enter Key) to enter the value. The keypad disappears, and the “Pump Copy” screen shows the pump number you entered.

3. Touch the green **Copy to Single Pump** button. **Complete** briefly appears on the screen.
4. As appropriate, either continue copying to other pumps, or touch **Return** to go back to the “Pump Setup” screen.

- Copying to the Other Pump:

1. On the “Pump Copy” screen (
- 2.

3. Figure 12) touch the gray **First Pump** button. The keypad pops up.
4. Enter the pump number for the lower end of the range you are copying to. Use  (Backspace Key) to erase any mistakes. Use  (Enter Key) to enter the value. The keypad disappears, and the “Pump Copy” screen shows the pump number you entered under **First Pump**.
5. On the “Pump Copy” screen (Figure 12), touch the gray **Last Pump** button. The keypad pops up.
6. Enter the pump number for the upper end of the range you are copying to. Use  (Backspace Key) to erase any mistakes. Use  (Enter Key) to enter the value. The keypad disappears, and the “Pump Copy” screen shows the pump number you entered under **Pump Station**.
7. Touch the green **Copy to Range of Pumps** button. **Complete** briefly appears on the screen.
8. As appropriate, either continue copying to other pumps, or touch **Return** to go back to the “Pump Setup” screen.

### **Finishing Setup: Setting Up Passwords**

You can set up passwords for two levels of security: for operators and for setup personnel. The controller comes from the factory with neither password set. This allows every user access to all functions.

#### **Setup Password**

If you define a password for setup personnel, then most settings can be changed only after entering the password. The password will be required to display the following screens:

- System Setup (to review and change system-wide settings, clear the alarm log, and go to the network status screens).
- Station Setup (to review and change settings for all station options).
- Pump Setup (to review and change settings for all pump options).

#### **Operator Password**

If you define a password for operators, then a password will be required to carry out *any* function (other than reviewing station and pump status, silencing alarms, reviewing the alarm log, and looking at help screens). Entering the operator’s password will give the user access to the functions at the following screens:

- Station Status (to enable or disable a station, and start or stop system)
- Pump Status (to enable or disable a pump, and start or stop system)
- Station Operator (to adjust a station’s convey time and dump delay, activate priority convey, and review the station’s last convey time and pump assignment; depending on

the options installed, the screen may also enable the operator to adjust the mix percentage for a remote proportioning valve, review the last purge time and purge valve, and set the intended material line for material proofing).



Entering the setup password will give the user access to all functions.

**Note:** *If you want to protect the operator's functions with a password, you must also define a setup password. If you leave the setup password undefined, then all users will have access to all functions.*

*If you want two different levels of password protection, you must make the passwords different from each other. If the two passwords are the same. Then any user who enters the password will have access to all functions.*

To set (or remove) password protections, complete the following steps:

1. Go to the "System Setup" screen by touching the **Menu** button on any screen. Then touch **System Setup**. The "System Setup" screen will open.
2. On the "System Setup" screen (Figure 4), touch the **Operator Password** button or the **Setup Password** button, depending on which password you want to set up. A keypad pops up.
3. Enter up to four digits. If you want to remove password protection, enter 0 as the

password. Use  (Backspace Key) to erase any mistakes. Use  (Enter Key) to enter the value. The keypad disappears, and the "System Setup" screen shows the password you entered.



**Note:** *When entering a password, all four digits must be supplied. For example, if you enter a password of 2 here, you will need to enter 0002 when the controller prompts for the password.*

If desired, you can also change the duration for which a password remains effective. During operation, the password-protected screens are available either until the user logs off or until this time elapses, whichever comes first. This feature prevents the password from remaining active if a user forgets to log off.

**Note:** *The password timer starts when the user logs on. It expires even if the user is actively using the screens when the chosen time is up. If the timer expires, the system goes to the "Station Status" screen. Your password duration should be long enough to allow authorized users to complete their tasks but short enough to provide adequate protection against tampering.*

To change the duration of the password, complete the following steps:

1. On the "System Setup" screen (Figure 4), touch the **Operator Password Duration** button or the **Setup Password Duration** button, depending on which password duration you want to change. A keypad pops up.
2. Enter the number of minutes (between 1 and 99) that you want to set as the password

duration. Use  (Backspace Key) to erase any mistakes. Use  (Enter Key)

to enter the value. The keypad disappears, and the “System Setup” screen shows the new setting.

### **3-6 Initial Startup**

Once you have finished all the setup described above, you are ready to start the system. To start your system, complete the following steps.

1. At any screen, touch **Menu** on the right side of the screen. The “Menu” screen appears (Figure 3).
2. Touch **Stations**. The “Station Status” screen appears (Figure 6).
3. For each station that you want to use, briefly touch its icon. The icon turns blue, indicating that the station is ready, or the icon turns yellow, indicating that the station needs material.
4. Touch **Pumps**. The “Pump Status” screen opens (Figure 10)
5. For each pump that you want to use, briefly touch its icon. The icon turns blue, indicating that the pump is ready.
6. Touch **Push to Start System** in the lower right-hand corner of the screen.
7. The system starts. If any alarm messages appear on the screen, see p. 436.

# Chapter 4: Operation

## 4-1 Overview

Your 2-pump, 20-station controller electrically controls valves and solenoids to convey material from a central location to individual stations as needed. The controller senses demands for material at the stations and responds to the demands in a timely fashion.

This section gives the procedures for using your controller, and it covers tasks that can be carried out with no password or with an operator's password. The section is divided into three sub-sections:

- Basic tasks: tasks normally carried out by a station operator
- Advanced tasks: tasks normally carried out by setup personnel
- Alarms: silencing and clearing alarms

**Note:** Before you carry out any of the procedures in this chapter, the system must be set up as described in the previous chapter.

## 4-2 Basic Tasks

### Reviewing Station Status

The starting point for all operations is the "Station Status" screen. To reach this screen from any other screen, touch **Menu** on the right-hand side of the screen, and then touch **Stations**. The "Station Status" screen appears.

Figure 13: "Station Status" Screen During Operation

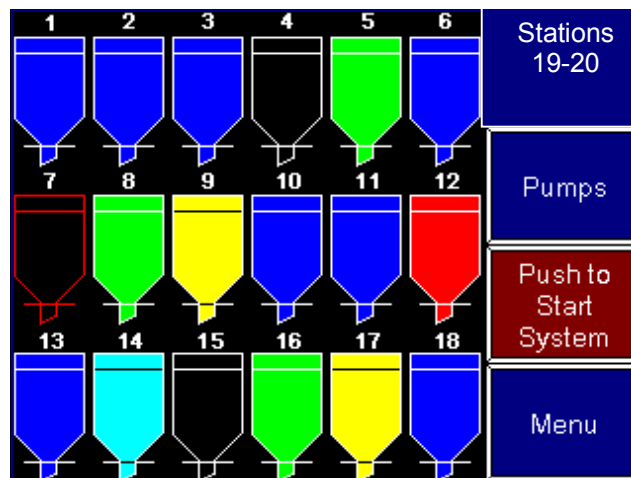

The status of each station is color-coded. You can see an explanation of each status by using the online help. To do so from this screen, complete the following steps:

1. Touch **Menu**. The "Menu" screen opens.
2. Touch **Help**. The "Help Menu" screen opens.
3. Touch **Station States**. The "Station Symbols Help" screen opens, explaining the status represented by each color.



4. When you are finished reviewing the information, touch **Return**. The “Help Menu” screen opens.
5. Touch **Menu** to return to the “Menu” screen.

The following table explains the status represented by each color at the “Station Status” screen.

Color	Label	Description
Gray outline	Offline	Station is not enabled. The controller ignores any demands or alarms.
Blue	Ready	Station is enabled and idle (full).
Yellow	Demand	Station requires material.
Green	Loading	Station is being loaded with material.
Light blue	Dumping	Station is dumping material into its receiver.
Green, blinking	Priority	Station is in priority convey mode. Its pump will be temporarily dedicated to filling it as soon as possible.
Red, blinking	Alarm	Station is in alarm.
Red outline, blinking	Critical	Station is in critical alarm. The controller has disabled the station until the alarm is cleared.

Additional basic information about each station (convey time, dump delay, and pump assignment) is available at the “Station Operator” screen. See page 314 for details.

Detailed configuration settings for each station are available at the “Station Setup” screen. See page 40 for details about each of these settings.

### Reviewing Pump Status

The “Pump Status” screen is the counterpart of the “Station Status” screen. To reach the “Pump Status” screen from any other screen, touch **Menu** on the right-hand side of the screen, and then touch **Pumps**. The “Pump Status” screen appears.

Figure 14: “Pump Status” Screen During Operation

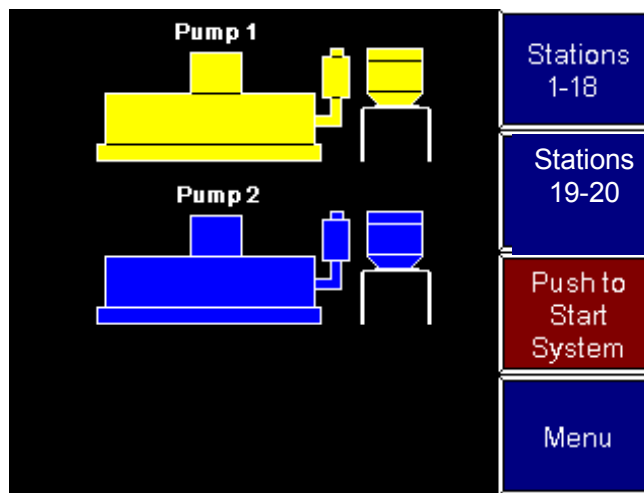

The status of each pump is color-coded. You can see an explanation of each status by using the online help. To do so from this screen, complete the following steps:

1. Touch **Menu**. The “Menu” screen appears.
2. Touch **Help**. The “Help Menu” screen appears.
3. Touch **Pump States**. The “Pump Symbols Help” screen appears, explaining the status represented by each color.
4. When you are finished reviewing the information, touch **Return**. The “Help Menu” appears.
5. Touch **Menu** to return to the “Menu” screen.

The following table explains the status represented by each color at the Station Status screen.

Color	Label	Description
Gray outline	Offline	Pump is not enabled. The controller ignores any alarms.
Yellow	Ready	Pump is off, waiting for demand from a station.
Blue	Idle	Pump is on, waiting for demand from a station. If there is no demand before the end of the auto shutdown delay, the pump will turn off.
Green	Loading	Pump is conveying material to a station.
Blue, blinking	Blow Back	Pump’s air filter is being cleaned by blowing compressed air backward through it.
Red, blinking	Alarm	Pump is in alarm.
Red outline, blinking	Critical	Pump is in critical alarm. The controller has disabled the pump until the alarm is cleared.

Additional basic information about each pump, including configuration settings and the number of hours the pump has been running, is available at the “Pump Setup” screen. For details on configuration settings, see page 422. For details on the hour meter, see page 33.

### **Logging On and Logging Off**

Your controller may be set up to require a password for any operation (other than reviewing station and pump status, silencing alarms, reviewing the alarm log, and looking at help screens). If so, touching a button will open the “Password Entry” keypad screen.

**Figure 15: “Password Entry” Screen**

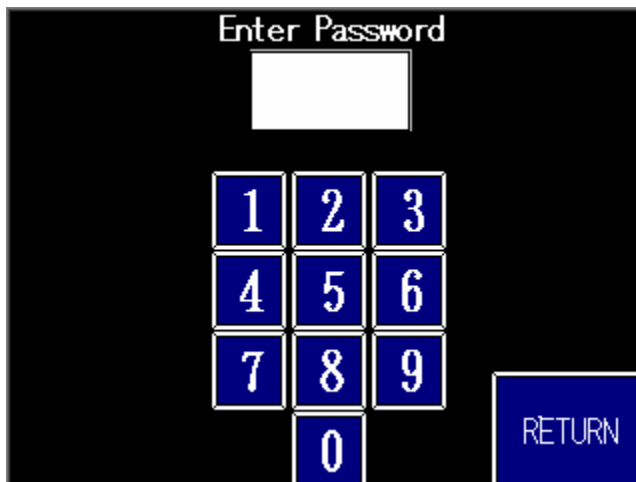

Enter the four-digit password (including any leading zeros). For example, if the password is 1, enter **0001**.

Each digit appears as an “**X**” as you touch it. When you touch the fourth digit, the controller carries out your request. For example, it enables or disables the requested pump or station, or it goes to the “Station Operator” screen. If you did not enter the correct password, the controller erases the entry. You can then try again. To give up, touch **Return**.

**Note:** *If you have lost the password(s), contact us for assistance.*

Once you have logged on, the password remains active until you log off or the password expires. (Setup personnel at your facility control the number of minutes before the password expires.) While the password is active, you can continue to carry out password-protected tasks without reentering the password. If the timer expires, the controller goes to the “Station Status” screen and you must reenter the password to continue working.

When you have finished any tasks that require the password, you should log off. (If you forget to do this, the controller will log you off when the password expires.) To log off, complete the following steps:

1. Go to the “Menu” screen by touching **Menu** from any other screen.
2. Touch **Log Off Password**. The “Station Status” screen opens.

### **Enabling and Disabling Stations and Pumps**

When a station or pump is disabled, the controller makes no attempt to use it and ignores any alarms that occur for it. Disabling a station or pump at the controller’s screen is similar to bypassing a station with its bypass switch. Enabling a station or pump makes it available for use.

**Note:** *For a station to be available for the system, it must be enabled at the controller’s screen and its bypass switch must be in the “0” position.*

To enable or disable a station (or pump), complete the following steps:

1. Go to the “Station Status” (or “Pump Status”) screen, if needed. To reach this screen from any other screen, touch **Menu** and then **Stations** (or **Pumps**).

Each disabled station (or pump) has an icon with a status of “offline” (black with a gray outline). All other statuses are enabled statuses.

2. Touch the icon for the station (or pump) briefly. The station (or pump) switches to the new state, as indicated by the color of its icon.

**Note:** *If the “Station Operator” (or “Pump Setup”) screen appears when you touch the icon, then you have kept your finger on the screen too long. Touch **Stations** (or **Pumps**) to return to the “Status” screen and try again. If you find it difficult to touch the icon briefly enough, ask the setup personnel at your facility to lengthen the touch switch delay.*

## Starting and Stopping the System

**WARNING!** *In an emergency, you can use the power switch at the controller cabinet if a password is required to stop the system and you do not know the password.*

**Note:** *Normally, all the stations and pumps you want to use should be enabled before you start the system. When the system is stopped, icons for enabled stations are blue and icons for enabled pumps are yellow. Enabling stations and pumps is described on p. 303.*

A button to start and stop the system is located in the lower right of the “Station Status” and “Pump Status” screens. When the system is off, the button is red and reads **Push to Start System**. When the system is on, the button is green and reads **Push to Stop System**. Depending on the setup at your facility, the system may prompt for a password when you touch this button.

**Note:** *If conveying does not begin when you start the system, check to make sure that all needed pumps are enabled. If they are, check that all needed stations are enabled.*

## Reviewing and Adjusting Basic Station Settings

The 2-pump, 20-station controller has a “Station Operator” screen for each station, as shown below. This screen enables you to review and adjust all basic settings for the station.

To reach the “Station Operator” screen, complete the following steps:

1. Go to the “Station Status” screen, if needed. To reach this screen from any other screen, touch **Menu**, and then touch **Stations**.
2. Touch and hold the icon for the station, until the controller either prompts for the password or displays the “Station Operator” screen. Once you have entered the password (if needed), the “Station Operator” screen appears.



Figure 16: “Station Operator” Screen

Back	<b>STATION 1 OPERATOR</b>	Next
<b>Convey Time</b> 30 Secs	<b>Last Convey</b> 26 Secs	Stations
<b>Dump Delay</b> 15 Secs	<b>Assigned To Pump</b> 1	Station Setup
<b>Priority Convey Activate</b>		Menu

Settings in the box labeled **Convey**, the red **Priority Convey Activate** button, and the menu controls on the right-hand side of the screen appear for all stations. Buttons in light gray are settings that you can adjust at this screen. Boxes in dark gray are for display only. If a pump assignment needs to be changed, this must be done at the “Station Setup” screen.

### ***Navigating Among the Station Operator Screens***

The controls in the upper right-hand corner of the screen enable you to move among the “Station Operator” screens:

- To display the screen for the next lower-numbered station (for example, to move from the screen for Station 15 to the screen for Station 14), touch ◀ **Back**.
- To display the screen for the next higher-numbered station (for example, to move from the screen for Station 15 to the screen for Station 16), touch **Next** ▶.
- To display the screen for a specific station, touch **Goto**. A keypad pops up. Enter the number for the desired station. Use  (Backspace Key) to erase any mistakes. Use  (Enter Key) to enter the value.
- To exit to the “Station Status” (or “Pump Status”) screen, touch **Stations** (or **Pumps**).

### ***Adjusting Convey Time and Dump Delay***

Convey time is the length of time the station’s vacuum valve remains open to allow material to be drawn in. (For a volume-fill station, the valve closes when material covers the station’s volume-fill proximity sensor or this time elapses, whichever comes first.)

Dump delay is the length of time allowed for material to drain from the station into its receiver. During this time, the controller does not attempt to deliver any more material to the station.



The settings for convey time and unload time should match the times actually required to fill and empty the station. The following problems may occur if these settings are incorrect:

- Material is backing up and causing “high vacuum” alarms (for time-fill stations only): Convey time is too long.
- System is not keeping up with the demand for material: Convey time is too short, or dump delay is too long.

For your reference, the “Station Operator” screen shows the length of time the controller actually spent conveying material during the most recent delivery under **Last Convey Time**.

To adjust a station’s convey time (or the dump delay), complete the following steps:

1. Go to the “Station Operator” screen by touching and holding a station icon, or go to the “Station Setup” screen.
2. Touch **Convey Time** (or **Dump Delay**) A keypad pops up.

3. Enter the number of seconds desired for convey time or dump delay. Use  (Backspace Key) to erase any mistakes. Use  (Enter Key) to enter the value. The new setting appears under **Convey Time** (or **Dump Delay**).

### **Activating and Stopping Priority Convey for a Station**

**Note:** *Before activating priority convey, make sure that all other stations using the same pump have adequate material in reserve to continue operation. No material will be conveyed to these stations during priority convey.*

If you want the controller to fill a specific station with material immediately, you can activate “priority convey” for that station. When you do so, the controller temporarily dedicates the station’s pump to it, ignoring demands from other stations assigned to that pump. Once the chosen station is full, normal operation resumes.

You can also use this feature to give one station a “head start” by conveying a few loads to it and then stopping the priority convey.

No more than one station for a given pump can be in “priority convey” at once. To activate priority convey, complete the following steps:

1. Go to the “Station Operator” by touching and holding a station icon, or go to the “Station Setup” screen.
2. Touch **Priority Convey Activate**. The button changes to **Priority Convey Active** and blinks until the station’s demand has been satisfied (or you stop the priority convey). The controller begins filling the chosen station only (after finishing any conveying already in progress).
3. To stop a priority convey before the station is completely full, touch the blinking **Priority Convey Active** button. The button changes to **Priority Convey Activate** and stops blinking. The controller finishes the current convey, if any, and resumes normal operation.

## **4-3 Adjusting Advanced Settings**

This section describes the procedures carried out during operation that are normally reserved for setup personnel. These procedures require use of the setup password (if your facility has defined one). The procedure for logging on and off with the setup password is the same as for logging on with the operator password; see p.32 for step-by-step instructions for logging on and off.

### **Reviewing and Resetting a Pump Hour Meter**

The controller keeps two meters for the length of time a pump has run. One, like a car’s odometer, keeps a running total and cannot be reset. The other, like a car’s trip odometer, counts the running time since the last reset.

To review and reset the hour meter, complete the following steps:

1. At any screen, touch the **Menu**, and then touch **Pumps**. The “Pump Status” screen opens.
2. Touch and hold the icon for the pump. The “Pump Setup” screen opens.

Figure 17: Pump Setup Screen

Idle Time 30 Sec	<b>PUMP 1 SETUP</b>	<b>Transfer to Standby</b>	Next
<b>Hour Meter Reset</b>	<b>0</b> HOURS Resettable	<b>0</b> HOURS	Back
<b>Blowback Disabled</b>	<b>Blowback Every 5 Loads</b>	<b>Blowback Every 5 Pulses</b>	Goto ***
<b>ON Time</b> <b>0.2</b> Secs	<b>OFF Time</b> <b>2.0</b> Secs	<b>Pump Fault Disabled</b>	Copy
			Pumps
			Menu

The box labeled **x Hours Resettable** shows the running time since the last reset. The box labeled **x Hours** shows total running time.

To reset the resettable meter, touch **Hour Meter Reset**. The time above **Hours Resettable** changes to 0.

#### ***Transferring Stations to a Standby Pump***

If a pump fails, you can transfer all of the controller's station assignments for that pump to a standby pump. To do this, you must disable (take offline) both the source pump and the standby pump, and the standby pump must have no stations already assigned to it.

The transfer operation at the controller's touch screen merely changes the pump assignment for every station on the failed pump. It does not transfer any pump settings for auto shutdown delay, alarms, or blow-back to the standby pump. Mechanical connections must be changed manually.

To transfer stations from a pump to a standby pump, complete the following steps:

1. At any screen, touch **Menu**, and then touch **Pumps**. The "Pump Status" screen appears.
2. Both the source pump and the standby pump must be offline. If either pump is any other state, disable it by touching its icon briefly. The icon becomes black with a gray outline.
3. Move the vacuum hose from the failed pump to the standby pump, and carry out any other mechanical procedures needed to use the standby pump.
4. At the "Pump Status" screen, touch and hold the icon for any pump until the "Pump Setup" screen appears.
5. At the "Pump Setup" screen, touch **Transfer Stations To Standby Pump**. The "Transfer to Standby Pump" screen opens:

Figure 18: “Transfer To Standby Pump” Screen

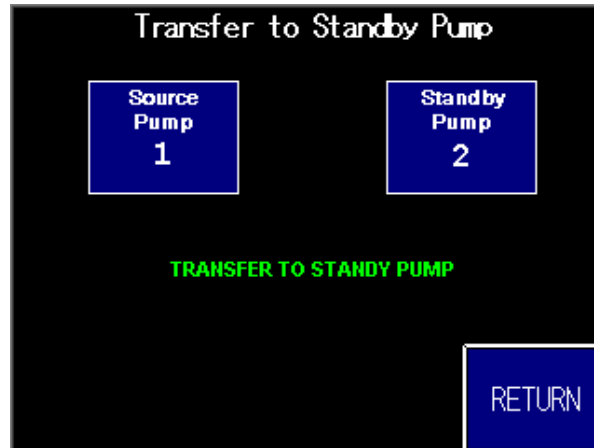





6. Touch Source Pump. The keypad pops up.
7. Enter the number of the failed pump. Use  (Backspace Key) to erase any mistakes. Use  (Enter Key) to enter the value. The number appears under **Source Pump**.
8. Touch **Standby Pump**. The keypad pops up.
9. Enter the number of the standby pump. Use  (Backspace Key) to erase any mistakes. Use  (Enter Key) to enter the value. The number appears under **Standby Pump**, and a button labeled **Transfer to Standby Pump** appears on the screen.

Figure 19: Transfer To Standby Pump Button



**Note:** When you enter the second pump number, the controller checks to make sure that both pumps are offline and that the standby pump has no stations assigned to it.

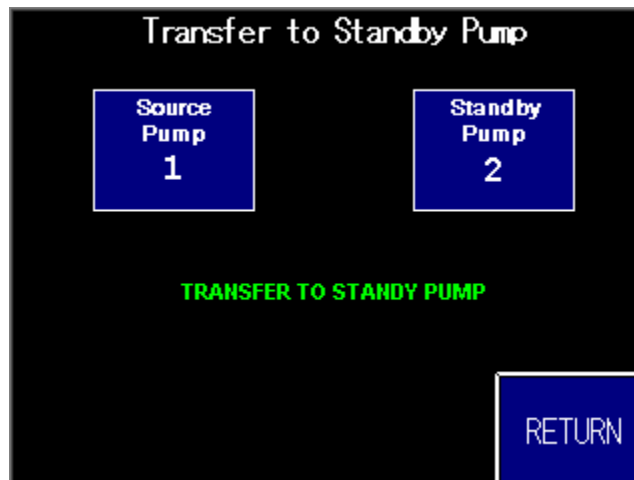

*If these conditions are not all met, error messages appear on the screen instead of a **Transfer to Standby Pump** button. If you get an error message, first check to make sure that you have entered the correct numbers and reenter if necessary. If another error occurs, see the Standby Pump Errors section below.*

10. Touch **Transfer To Standby Pump**. “Transfer in Progress” appears briefly on the screen, followed by “Transfer Complete,” in place of the **Transfer To Standby Pump** button. The controller switches the setting for **Source Pump** to the new pump and switches the setting for **Standby Pump** to 0 (unassigned).
11. Touch **Return**, and then **Pumps** to return to the “Pump Status” screen.
12. Put the standby pump online by briefly touching its icon. The icon changes color to show the new status, and the system begins using the pump. In addition, all “Station Operator” and “Station Setup” screens show the new pump assignment.

When the failed pump is operational again, you can repeat this process, this time using the standby pump’s number as the setting for **Source Pump** the repaired pump’s number as the setting for **Standby Pump**.

### **Standby Pump Errors**

If the error message tells you to disable the source pump and/or the standby pump, touch **Return** at this screen, then **Pumps** at the “Pump Setup” screen. Take the pumps offline and then return to the “Transfer to Standby Pump” screen.

If the error message tells you that the standby pump has stations assigned, you must either use a different standby pump or you must remove the pump assignment for all stations assigned to the standby pump. To remove the assignments, complete the following steps:

1. Touch **Return** at the “Standby Pump” screen, and then touch **Menu**.
2. From the “Menu” screen, touch **Stations**.
3. Touch and hold a station icon to get to the “Station Operator” screen.
4. Then touch **Setup** to go to the “Station Setup” screen.
5. Use ◀ **Back**. and **Next** ▶ to review all pump assignments.
6. Where necessary, choose **Assigned to Pump #n** to set station assignments to 0 (unassigned). Then return to the “Transfer to Standby Pump” screen.

## **4-4 Alarms**

### **Reviewing Alarms**

To review your system’s alarms, touch **Alarms** on “Menu” screen. The “Alarm Log” screen appears, with the newest alarm listed first.

**Note:** *Alarm log is not resettable! Log holds the 100 most recent alarms.*

**Figure 20: Alarm Log Screen**

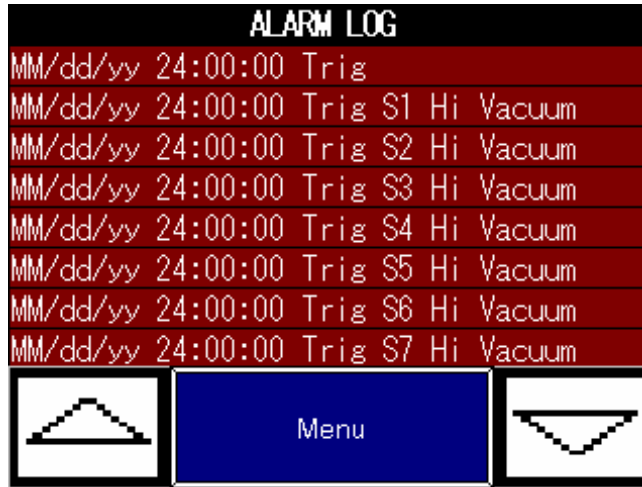

To scroll up and down through the list, touch ▲ and ▼ at the bottom of the list.

### **Silencing Alarms**

Whenever a new alarm occurs, your controller sounds the horn and turns on the strobe light at each central alarm.

Touch **Alarm Silence** on the alarm message banner that appears when a new alarm occurs or press the physical push button included in the central alarm option.

The horns and lights at the central alarms turn off. Your controller has separate, configurable settings for how long the horns should remain silent and how long the lights should remain off. (see "Setting U1p Alarm Duration" on page 19). If the alarm condition still exists when either of these times elapses, the corresponding device (horn or lights) turn on again and the alarm message banner appears with a "Suppression/Silence Time Expired" message. If a new alarm occurs, both horns and lights turn on. See page 436 for a list of alarms and their possible causes.

# Chapter 5: Restoring a Lost or Corrupt Program

## 5-1 Corrective Maintenance

### PLC Memory Module

A PLC memory module (ACS Part# A0567138) loaded with the appropriate program for the system purchased is provided as both a backup in the event of a catastrophic failure and as a means to upgrade the PLC program.

Depending on the system purchased, the memory module will contain:

1. A0573702                      VTC 2/20 AC Inputs
2. A0573712                      VTC 2/20 DC Inputs

In the event that the PLC memory becomes corrupted, the memory module can be used to reload the PLC program with factory default values. The red FAULT indicator on the PLC indicates a problem with the PLC memory or an error in the internal settings and may be flashing or on steady. Follow the procedures below to reload the PLC program.

1. Open the front cover of the PLC by pulling on the tab above the words “Allen-Bradley” to expose the memory module socket. Refer to the diagram, item 7 shown below.

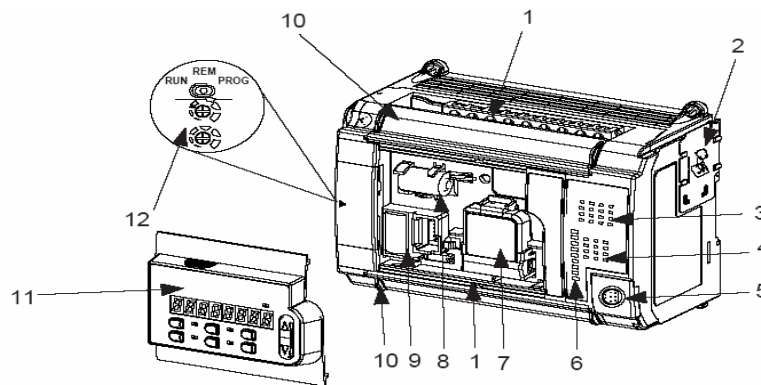

Feature	Description	Feature	Description
1	Removable Terminal Blocks	7	Memory Module/Real-Time Clock <sup>(1)</sup>
2	Interface to Expansion I/O, Removable ESD Barrier	8	Replacement Battery <sup>(1)</sup>
3	Input LEDs	9	Battery
4	Output LEDs	10	Terminal Doors and Label
5	Communication Port	11	Data Access Tool <sup>(1)</sup>
6	Status LEDs	12	Mode Switch, Trim Pots

2. Insert the memory module. Note: this step can be performed while the unit is powered, however care should be taken not to contact any wiring within the control cabinet.
3. Cycle power to the control cabinet allowing approximately 30 seconds for the DC power supply (if provided) to fully discharge.
4. After approximately 30 seconds, the PLC's green **RUN** indicator will flash indicating the PLC is reading the memory module. When complete, the PLC will automatically begin operation and the **RUN** indicator will be on solid.
5. Note that re-loading the memory module will restore *ALL* settings to their factory default values and the settings will have to be re-entered manually.

Contact ACS service at **1-800-423-3183** if the fault persists.

# Chapter 6: Configurable Settings/Defaults

This section describes the proper setup of the 2 pump, 20-station control system parameters. These parameters are operator changeable; however, these items should require setup only during the initial installation. Only authorized personnel should change them.

Many of the variables and setup parameters have been preset at the factory and do not need to be changed. However, this section of the manual will address all of the setup parameters that were available at the time of printing. The purpose of this is to familiarize the reader with all the setup parameters and their usage.

## 6-1 Station Setup - Factory Presets

Name	Description	Options	Default
<b>Conveying Options</b>			
<b>Convey time</b>	Length of time the station's vacuum valve remains open to allow material to be drawn in. (For a volume-fill station, the valve closes when material covers the station's volume-fill proximity sensor or this time elapses, whichever comes first.)  Adjust this value to match the actual time needed to fill the station.	1-999 sec.	30 sec.
<b>(Last convey time)</b>	<i>Display only.</i> Length of time the station's vacuum valve was open for receiving material during the most recent convey. This information is displayed for your reference when adjusting convey time and dump delay.	—	—
<b>Dump delay</b>	Length of time allowed for material to drain from the station into the receiver. The controller will not attempt to deliver more material to the station until this time has elapsed.  Adjust this value to match the actual time needed to drain the station. If it is set too short, the controller may attempt to refill the station before it is empty, causing material to back up and/or underusing the station's capacity. If it is set too long, the system may be unable to keep up with your equipment's demand for material.	1-99 sec.	15 sec.
<b>Assigned to pump <i>n</i></b>	Number (address) of the pump to which this station's vacuum line is connected.	0-2 (0 = not assigned)	0
<b>Special convey</b>	When this option is enabled, the station's vacuum valve remains open for the convey time, even if the station is not demanding material and is indicating that it is full. When disabled, the station's vacuum valve opens when there is demand from the station, and it remains open until the convey time has elapsed or material trips the volume-fill proximity switch. Enable this option if and only if the station has no flapper.	disabled, enabled	disabled

Name	Description	Options	Default
Alarm Options			
<b>No convey</b>	<p>When this option is enabled, the controller issues a “no convey” alarm if it has repeatedly attempted to convey material to the station but the flapper never opened during the dump delay. (The number of attempts is controlled by the next setting.)</p> <p>Usually this option should be enabled. At times, you may wish to disable it during operation as a stopgap measure for dealing with an alarm.</p>	disabled, enabled	disabled
<b># attempts before alarm</b>	<p>Number of attempts before alarm: the number of times the controller will attempt to convey material to a station before it issues a “no convey” alarm. The setting for this option depends on (a) how much material your injection mold uses to make each part compared with the capacity of the receiver and (b) how important it is to keep your injection mold from running out of material and shutting down. A higher setting will give you fewer alarms, at the risk of emptying the receiver without warning. A lower setting will give more frequent alarms, at the risk of disrupting operations unnecessarily.</p>	1–99	3

## 6-2 Pump Setup - Factory Presets

Several of the items in this screen are not setup options but are instead intended for use during operation. These items (hour meter and transferring stations to a standby pump) are described in Chapter 4, which cover operation procedures.

Name	Description	Options	Default
<b>Idle Time Options</b>			
<b>Auto shutdown delay</b>	Length of time the pump continues to run unloaded without demand from any station. After this time has elapsed, the pump shuts down to save power and to prevent wear on the pump. <b>Adjust this setting to fit the needs of your facility in trading off the savings against the costs associated with waiting for a pump to start up when there is a demand for material.</b>	0–999 sec.	45 sec.
<b>Alarm Options</b>			
<b>Pump fault</b>	The control has one input/pump that you can wire to generate alarms for situations of your choosing. For example, you may have a sensor that turns on when material reaches the top of a filter-chamber waste bin. When this option is enabled, the controller issues an alarm if the sensor wired to the input for Pump Fault turns on. <b>Enable this option if and only if your facility has installed a miscellaneous alarm on the input for Pump Fault for this pump.</b>	disabled, enabled	disabled
<b>Blow Back Options</b>			
<b>Blow back</b>	When this option is enabled, the controller periodically sends air backward through the pump's air filter to dislodge accumulated dust and debris. <b>Enable this option if and only if the pump has the equipment for filter cleaning.</b>	disabled	disabled
<b>Every <i>n</i> loads</b>	Number of conveying cycles to stations between filter cleanings. Adjust this setting based on experience. The more dust and debris in your material line, the smaller this number needs to be.	1–99	5
<b># pulses</b>	Number of pulses of air sent through the pump's filter during cleaning. If filter-cleaning is not working as desired, the service department may ask you to change this setting.	1–99	5
<b>On time</b>	Number of seconds that the output remains on for each pulse during filter cleaning. If filter-cleaning is not working as desired, the service department may ask you to change this setting.	0.1–99.0 sec.	1.0 sec.
<b>Off time</b>	Number of seconds between pulses during filter cleaning. If blow-back is not working as desired, the service department may ask you to change this setting.	0.5–99.0 sec.	1.0 sec.

# Chapter 7: Troubleshooting

## 7-1 General Troubleshooting

Problem	Possible Cause	Solution
The control panel doesn't light up at all	The control panel is not turned on.	Turn on the control panel.
	The external disconnect (recommended) in the dedicated circuit is open (off).	Close the switch (on).
	Fuse/circuit breaker in the power drop is blown/tripped.	Replace/reset.
	Control power switch is broken.	Replace.
The touch screen display doesn't come on when the control panel is powered up.	Fuse in display is blown.	Replace.
	Loose wiring to display.	Repair.
	Power supply problem.	Check 24V DC source.
	Display is faulty.	Replace.
A pump package doesn't run, even though it is on-line and its indicator is lit.	The motor overload has tripped.	Reset the overload and check the motor for the proper amp draw on tag.
	Hoppers not assigned/no demand.	Check hopper assignment, verify hoppers are online.
	Main fuse in power drop or optional fused disconnect has blown.	Replace the fuse.
	Motor contact is faulty.	Repair or replace as required.
A vacuum receiver is being bypassed in the loading cycle.	The hopper is off-line.	Use the controller to put the vacuum receiver on-line.
	Faulty level sensor or loose.	Check level sensor/wiring.
	The convey time for the hopper is set to zero.	Use the controller to enter a longer convey time.
	The field-installed station bypass switch is simulating a Bin Full condition.	Normal operation. Set the switch so the vacuum receiver is back in the loading sequence.
	The field-installed station bypass switch is bad or mis-wired.	Repair, replace, or re-wire.
	The vacuum receiver was assigned to the wrong pump during setup.	Repeat the setup procedure and verify that the pump is on.
Vacuum hoppers are overfilling.	Conveying times are too long (Time Fill Mode only).	Time the vacuum receiver (s) during loading, and set the conveying times to a few seconds less.
	Maximum conveying times are too long, and the PLC does not recognize the Vacuum Receiver Full Proximity Switch(es).	Check proximity sensors for proper operation and proper wiring to the PLC. Repair as needed. Reset the conveying times to a reasonable value, and adjust as needed.
	Special convey is enabled and convey time is too long.	Disable special convey. Reduce convey time.
Power is present but control will not function.	Check PLC. See if fault light is on.	Reload software. See page 43.
	Loose communication cable between PLC and display	Verify wiring.



## 7-2 Alarms

The format for all station alarms is “Station *n* [alarm text].” The format for all pump alarms is “Pump *n* [alarm text].” Any alarm that does *not* start with “Station” or “Pump” is a system alarm.

The following tables list all alarms alphabetically, together with possible causes. A “critical” alarm is one that causes the affected device to stop.

**Note:** You can also see a list of alarms and their causes in the controller’s online help. To display this information, touch the color key of statuses in the upper right-hand corner of either the “Station Status” or the “Pump Status” screen, or touch **Help** at any other screen. When you are finished reviewing the help, touch **Return**.

### Station Alarms

Alarm message	Possible cause
High vacuum	Material line is blocked.
	Pulling bag at gaylord.
	Vacuum line is blocked.
	Convey time is too long (time-fill station only).
	Sequence valve has malfunctioned.
	No compressed air.
	Vacuum switch has malfunctioned.
<i>Note:</i> After you have corrected the cause of this alarm, the alarm will be cleared when the controller has conveyed a full load to this station.	
No convey	Material container is empty.
	No compressed air to vacuum pump.
	Material line is disconnected from material source.
	Faulty atmospheric valve pump.
	Vacuum line is disconnected from station.
	Pump power is interrupted.
	Take-off compartment is not adjusted properly.
	Convey time is too short.
	Faulty sensor does not detect material.
<i>Note:</i> As a stopgap measure, you can disable the “no convey” alarm for this station until the problem can be remedied. See page 46.	
Not assigned ( <i>Critical</i> )	Station has not been assigned to a pump

### Pump Alarms

Alarm message	Possible cause
Pump failure ( <i>Critical</i> )	Circuit breaker or overload protector has tripped. Contactor has malfunctioned.
Pump fault	(Function determined by your facility.)

### System Alarms

Alarm message	Possible cause
Low battery	Battery for the controller is defective.
	Batter for the controller is old and drained.
	Battery terminals loose/not connected.

# Chapter 8: Appendix

---

## 8-1 Warranty

The manufacturer warrants all equipment manufactured by it to be free from defects in workmanship and material when used under recommended conditions. The company's obligation is limited to repair or replace FOB the factory any parts that are returned prepaid within one year of equipment shipment to the original purchaser, and which, in the company's opinion, are defective. Any replacement part assumes the unused portion of this warranty.

This parts warranty does not cover any labor charges for replacement of parts, adjustment repairs, or any other work. This warranty does not apply to any equipment which, in the company's opinion, has been subjected to misuse, negligence, or operation in excess of recommended limits, including freezing or which has been repaired or altered without the company's express authorization. If the serial number has been defaced or removed from the component, the warranty on that component is void. Defective parts become the property of the warrantor and are to be returned.

The company is not liable for any incidental, consequential, or special damages or expenses. The company's obligation for parts not furnished as components of its manufactured equipment is limited to the warranty of the manufacturers of said parts.

Any sales, use, excise, or other tax incident to the replacement of parts under this warranty is the responsibility of the purchaser.

The company neither assumes nor authorizes any other persons to assume for it any liability in connection with the sale of its equipment not expressed in this warranty.

Many types of the manufacturer's equipment carry an additional one-year service policy. Consult your sales representative for specific details.

## 8-2 Drawings and Diagrams

*Review electrical drawings supplied in the packet with this manual.*

*For Control Panels with 120V AC outputs use:*

A0569842 Control Panel layout

A0569879 Electrical/Wiring Schematics (4 per set)

*For Control Panels with 24V DC outputs use:*

A0569844 Control Panel Layout

A0569880 Electrical/Wiring Schematics (4 per set)

## 8-3 Spare Parts List

### AC Voltage

Quantity	Part Number	Description
1	A0563932	2.1A Power Supply for touch screen
1	A0559862	Input Card
1	A0572817	Output Card
1	A0569858	PLC.Base
1	<b>A0565880</b>	<b>PLC CPU (request Pre-programmed)</b>
1	<b>A0573717</b>	<b>6" Touch screen (Pre-programmed)</b>
1	<b>A0573702</b>	<b>Program, Memory Module, AC inputs</b>
2	A0569859	Air Grill with Filter
1	A0541611	Fuse, MDL – .75
4	A0540997	Fuse, MDL – 1
1	A0540993	Fuse, MDL – .5
1	W00020354	Fuse, MDL – 1.25
1	A0563910	Power line filter/noise supressor
1	A0558091	Alarm audible/Horn 120V AC
1	A0530479	Alarm strobe/visual 120V AC
1	A0572812	Alarm assy. 120V Ac (with both audible & visuals)

### DC Voltage

Quantity	Part Number	Description
1	A0569866	5A Power Supply
1	A0551976	Input Card
1	A0572817	Output Card
1	<b>A0565880</b>	<b>PLC CPU (request Pre-programmed)</b>
1	<b>A0573717</b>	<b>6" Touch screen (Pre-programmed)</b>
1	<b>A0573712</b>	<b>Program, memory module, DC inputs</b>
2	A0569859	Air Grill with Filter
3	A0540997	Fuse, MDL – 1
2	A0542200	Fuse, MDL – 1.5
1	A0542204	Fuse, MDL – 2.25
1	W00020354	Fuse, MDL – 1.25
1	<b>A0563910</b>	<b>Power line filter/noise supressor</b>
1	<b>A0536986</b>	<b>Alarm audible/Horn 24V DC</b>
1	<b>A0542566</b>	<b>Alarm strobe/visual 24V DC</b>
1	<b>A0572813</b>	<b>Alarm assy. 24V DC (with both audible &amp; visual)</b>
1	<b>A0565881</b>	<b>CPU, Base</b>

## 8-4 Technical Assistance (Contact Information)

### ***Parts Department***

Call toll-free 7am–5pm CST [800] 423-3183 or call [630] 595-1060, Fax [630] 475-7005

The ACS Customer Service Group will provide your company with genuine OEM quality parts manufactured to engineering design specifications, which will maximize your equipment's performance and efficiency. To assist in expediting your phone or fax order, please have the model and serial number of your unit when you contact us. A customer replacement parts list is included in this manual for your convenience. ACS welcomes inquiries on all your parts needs and is dedicated to providing excellent customer service.

### ***Service Department***

Call toll-free 8am–5pm CST [800] 233-4819 or call [630] 595-1060

Emergencies after 5pm CST, call [847] 439-5655

We have a qualified service department ready to help. Service contracts are available for most products.

### ***Sales Department***

Call [630] 595-1060 Monday–Friday, 8am–5pm CST

Our products are sold by a world-wide network of independent sales representatives. Contact our Sales Department for the name of the sales representative nearest you.

### ***Contract Department***

Call [630] 595-1060 Monday–Friday, 8am–5pm CST

Let us install your system. The Contract Department offers any or all of these services: project planning; system packages including drawings; equipment, labor, and construction materials; and union or non-union installations.

## Free Manuals Download Website

<http://myh66.com>

<http://usermanuals.us>

<http://www.somanuals.com>

<http://www.4manuals.cc>

<http://www.manual-lib.com>

<http://www.404manual.com>

<http://www.luxmanual.com>

<http://aubethermostatmanual.com>

Golf course search by state

<http://golfingnear.com>

Email search by domain

<http://emailbydomain.com>

Auto manuals search

<http://auto.somanuals.com>

TV manuals search

<http://tv.somanuals.com>