

Connect supplies Flush lines

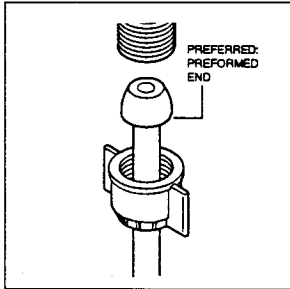

1 Connect water supply tubes to hot and cold faucet shanks with coupling nuts supplied. **FINGER** tighten. **NOTE:** Do not use supply tubes w/metal formed ends with non-metallic shanks.

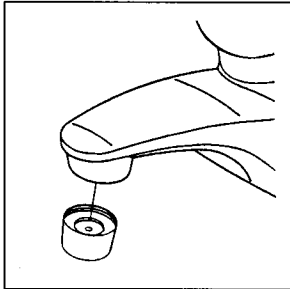

2 Turn on water supplies and check for leaks. With faucet off, remove aerator. Turn on hot and cold water to flush lines and faucet. Turn off faucet and replace aerator.

Sterling Limited Lifetime Warranty

Sterling Plumbing Group, Inc. ("Sterling") warrants this faucet to be free of manufacturing defects and to be drip free for as long as you own your home. Damage due to improper installation, maintenance or handling are not considered manufacturing defects and are not covered by this warranty. Labor, shipping and installation costs or other charges incidental to warranty service are to be borne by the original purchaser. This warranty is valid for the original purchaser only.

Sterling will, at its election, repair or replace a faucet where Sterling's inspection discloses any such defects occurring in normal residential usage.

To obtain warranty service return the defective part(s) to your cooperating retail seller or send them to our Customer Service Department, P.O. Box 427, Sheridan, AR 72150. Refer any questions to our Customer Service Department at 1-800-245-2207.

IMPLIED WARRANTIES INCLUDING THAT OF MERCHANTABILITY AND FITNESS FOR A PARTICULAR PURPOSE ARE EXPRESSLY LIMITED TO ONE YEAR FROM DATE OF PURCHASE. STERLING DISCLAIMS ANY RESPONSIBILITY FOR SPECIAL, INCIDENTAL OR CONSEQUENTIAL DAMAGES. Some states do not allow limitations on how long an implied warranty lasts, or the exclusion or limitation of special, incidental or consequential damages, so these limitations or exclusions may not apply to you. This warranty gives you special legal rights. You may also have other rights which vary from state to state.

This is our exclusive written warranty.

For more information on Sterling Faucets, please call 1-800-STERLING.

E043800

5/99

STERLING

P.O. Box 427, Oklahoma Street
Sheridan, Arkansas 72150-0427
Download from www.Somanuals.com. All Manuals Search And Download.

STERLING

A KOHLER COMPANY

INSTALLATION INSTRUCTIONS

CERAMIC SINGLE CONTROL BATH FAUCET

With or Without Pop-Up

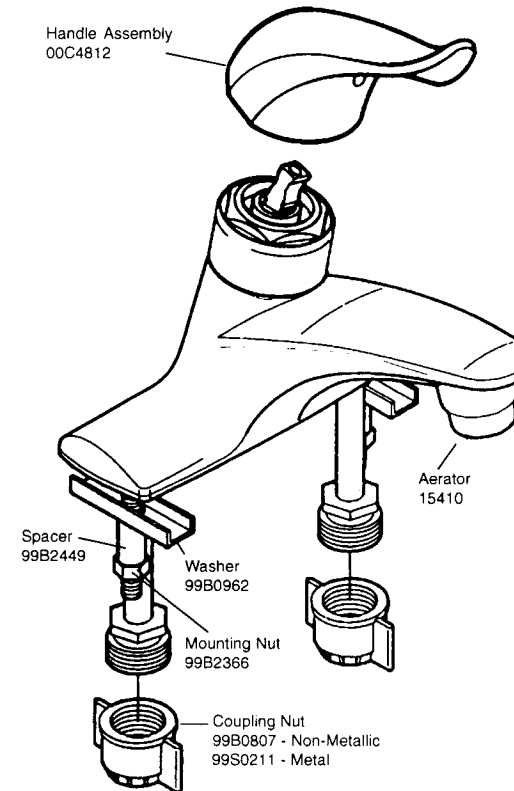

Before you begin

Use this diagram to familiarize yourself with the various parts of the faucet assembly. Make sure you have all the illustrated parts before you begin installation.

If you are putting in a new sink, it is easier to mount the faucet, drain and any other accessories **before** installing the sink into the countertop.

- Observe all local plumbing codes.
- Carefully inspect the valve parts for any damage.
- Flush all piping thoroughly before installing.
- Shut off hot & cold water supplies.
- Do not use plumber's putty or thread sealants on mounting nuts or coupling nuts.

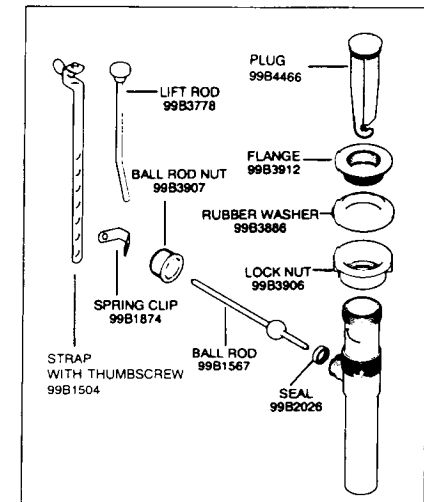

E043800

BATH FAUCET

2 Items you need

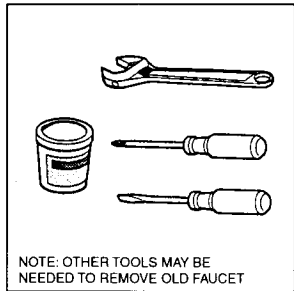

NOTE: OTHER TOOLS MAY BE NEEDED TO REMOVE OLD FAUCET

1 Adjustable wrench, Phillips and flathead screwdrivers, and Teflon tape.

OPTIONAL MATERIALS:

- Supply stops (2) Some installations may require stops to be installed.
- Supply tubing (2) and fittings will need to be provided.

NOTE: Do not use supply tubes w/metal formed ends with non-metallic shanks.

2 You may need the above materials.

HELPFUL OPTION

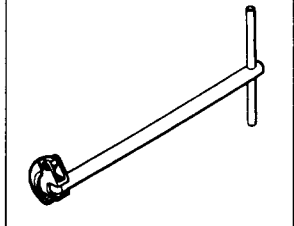

3 Basin wrench for removing old faucet.

3 Remove old faucet

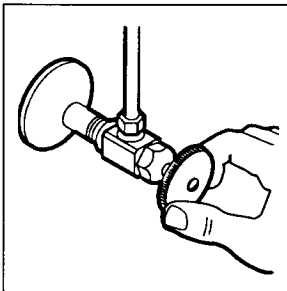

1 Turn off both water supplies at valves.

2 Disconnect supply lines.

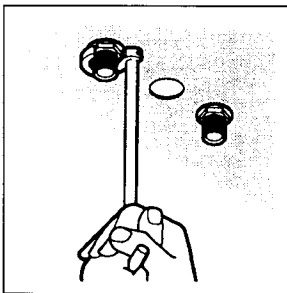

3 Remove mounting nuts, lift off faucet.

4 Install faucet

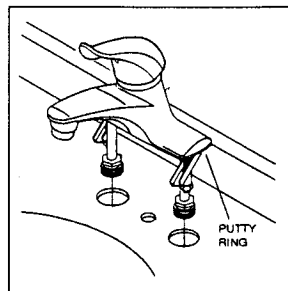

1 Place ring of putty around base edge of faucet. Loosely place washers, spacers, and nuts on threaded bolts. With washers angled, maneuver shanks and bolts through holes in deck.

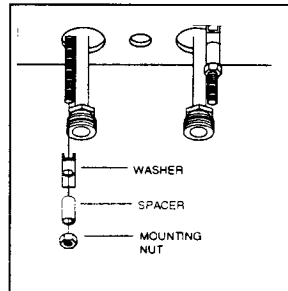

2 From underside of lavatory tighten mounting nuts until spacers and washers are flush with deck bottom. DO NOT OVERTIGHTEN. If deck is thick, spacers may be eliminated.

5 Install Pop-Up

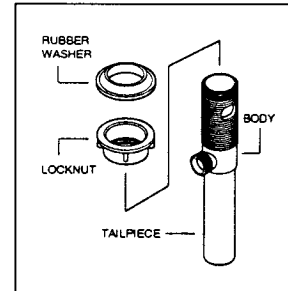

1 Thread locknut, flat side up, onto body. Slide rubber washer, beveled side up, onto body. Thread tail-piece into body.

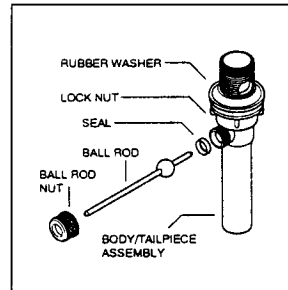

2 Place seal into opening of strainer tube with beveled edge out. Insert ball rod into strainer tube. Hand tighten ball rod nut.

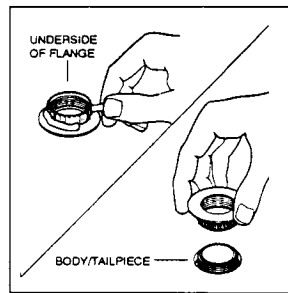

3 Place ring of putty around underside of drain flange. Insert strainer tube assembly up through hole of lavatory and screw flange onto top of strainer tube.

5 Install Pop-Up continued . . .

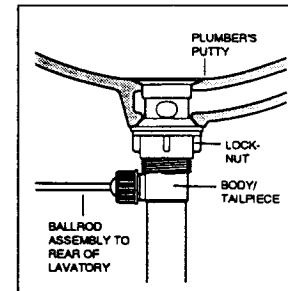

4 Drain flange should rest flush with lavatory basin. Tighten locknut securely against underside of lavatory. Ball rod assembly must be pointing to rear of lavatory.

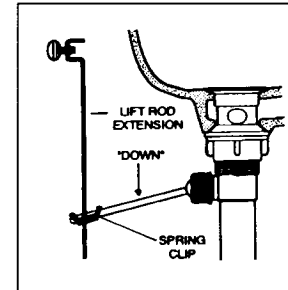

5 Place one end of spring clip over ball rod and slide back 1/2" to 1". Place ball rod through hole in strap that is appropriate for lavatory depth. Compress spring clip and slide ball rod through other spring clip hole to secure.

5 Install Pop-Up continued . . .

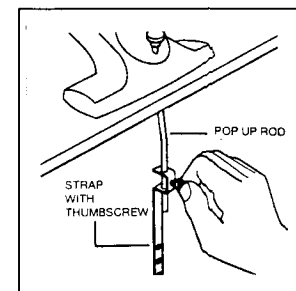

6 Insert pop-up rod down through hole in back of faucet. With ball rod in down position, attach strap to lift rod by securely FINGER tightening thumb screw.

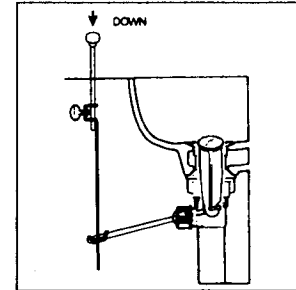

7 While pushing down on pop-up rod, insert plug into drain and turn 1/4 turn to engage stopper to ball lever rod.

STERLING
KOHLER

P.O. Box 427, Sheridan, AR 72150

Free Manuals Download Website

<http://myh66.com>

<http://usermanuals.us>

<http://www.somanuals.com>

<http://www.4manuals.cc>

<http://www.manual-lib.com>

<http://www.404manual.com>

<http://www.luxmanual.com>

<http://aubethermostatmanual.com>

Golf course search by state

<http://golfingnear.com>

Email search by domain

<http://emailbydomain.com>

Auto manuals search

<http://auto.somanuals.com>

TV manuals search

<http://tv.somanuals.com>