

STERLING

A KOHLER COMPANY

INSTALLATION INSTRUCTIONS

WASHERLESS NON-METALLIC BAR FAUCET

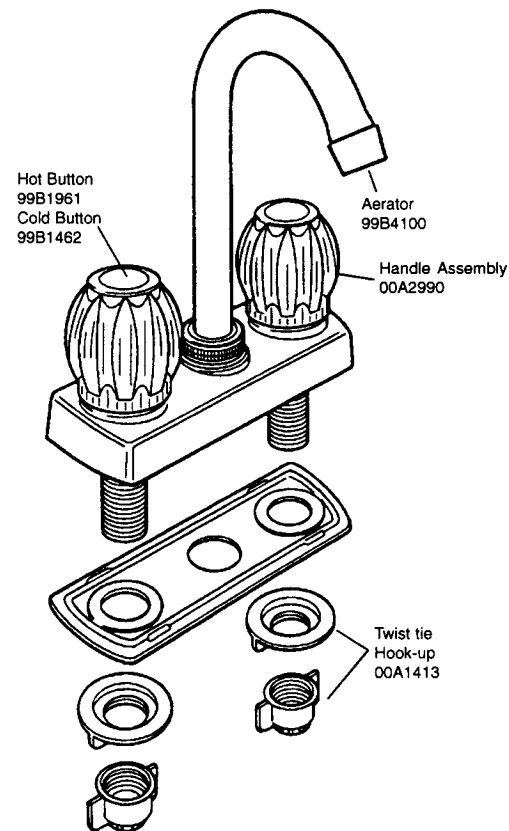

E045300

5/99

STERLING

A KOHLER COMPANY

P.O. Box 427, Oklahoma Street
Sheridan, Arkansas 72150-0427

Download from www.Somanuals.com. All Manuals Search And Download.

1

Before you begin

Use this diagram to familiarize yourself with the various parts of the faucet assembly. Make sure you have all the illustrated parts before you begin installation.

If you are putting in a new sink, it is easier to mount the faucet, drain and any other accessories **before** installing the sink into the countertop.

- Observe all local plumbing codes.
- Carefully inspect the valve parts for any damage.
- Flush all piping thoroughly before installing.
- Shut off hot & cold water supplies.
- Do not use plumber's putty or thread sealants on mounting nuts or coupling nuts.

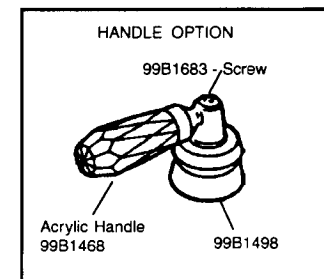

E045300

TWIN HANDLE BAR FAUCET

2 Items you need

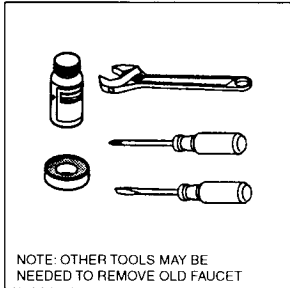

1 Adjustable wrench, pipe sealant or teflon tape, Phillips and flathead screwdrivers.

3 Remove old faucet

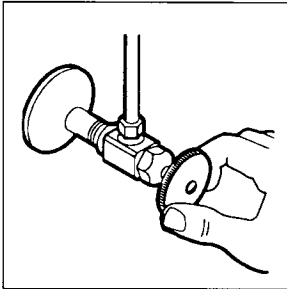

1 Turn off both water supplies.

4 Install faucet

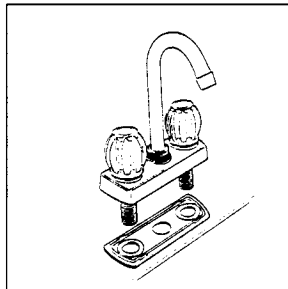

1 With putty plate in position, insert faucet shanks down through top of sink. Align faucet on sink.

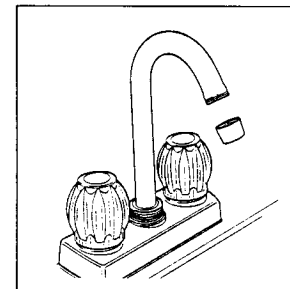

4 Unscrew aerator from the end of the spout. Turn on hot and cold water to flush lines and faucet. Turn faucet off and replace aerator.

OPTIONAL MATERIALS:

- Supply stops (2) Some installations may require stops to be installed.
- Supply tubing (2) and fittings will need to be provided.

2 You may need the above materials.

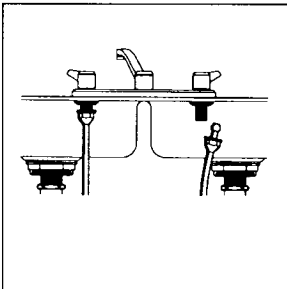

2 Disconnect supply lines.

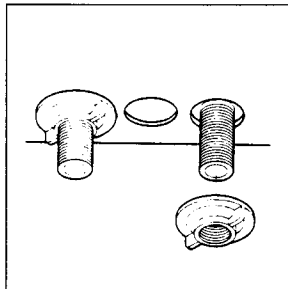

2 From underside of sink fasten faucet with plastic mounting nuts. FINGER tighten securely. DO NOT OVER TIGHTEN.

HELPFUL OPTION:

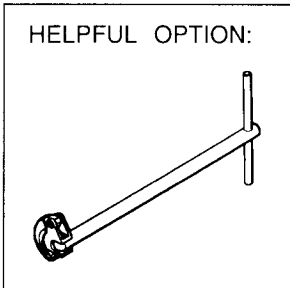

3 Basin wrench for removing old faucet.

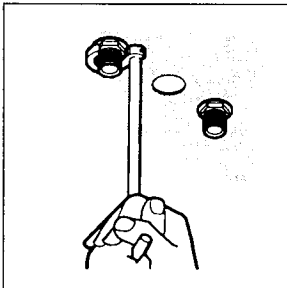

3 Remove mounting nuts, lift off faucet.

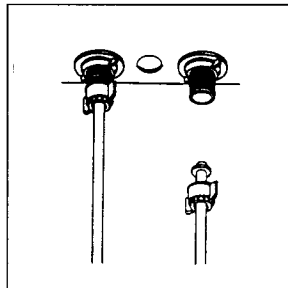

3 Connect hot and cold supply lines onto faucet shanks with coupling nuts. FINGER tighten securely.

5 Sterling Limited Five Year Warranty

Sterling Plumbing Group, Inc. ("Sterling") warrants this faucet to be free of manufacturing defects and to be drip free for five years. Damage due to improper installation, maintenance or handling are not considered manufacturing defects and are not covered by this warranty. Labor, shipping and installation costs or other charges incidental to warranty service are to be borne by the original purchaser. This warranty is valid for the original purchaser only.

Sterling will, at its election, repair or replace a faucet where Sterling's inspection discloses any such defects occurring in normal residential usage.

To obtain warranty service return the defective part(s) to your cooperating retail seller or send them to our Customer Service Department, P.O. Box 427, Sheridan, AR 72150. Refer any questions to our Customer Service Department at 1-800-245-2207.

IMPLIED WARRANTIES INCLUDING THAT OF MERCHANTABILITY AND FITNESS FOR A PARTICULAR PURPOSE ARE EXPRESSLY LIMITED TO ONE YEAR FROM DATE OF PURCHASE. STERLING DISCLAIMS ANY RESPONSIBILITY FOR SPECIAL, INCIDENTAL OR CONSEQUENTIAL DAMAGES. Some states do not allow limitations on how long an implied warranty lasts, or the exclusion or limitation of special, incidental or consequential damages, so these limitations or exclusions may not apply to you. This warranty gives you special legal rights. You may also have other rights which vary from state to state.

This is our exclusive written warranty.

For more information on Sterling Faucets, please call 1-800-STERLING.

STERLING
A KOHLER COMPANY

P.O. Box 427, Sheridan, AR 72150

Free Manuals Download Website

<http://myh66.com>

<http://usermanuals.us>

<http://www.somanuals.com>

<http://www.4manuals.cc>

<http://www.manual-lib.com>

<http://www.404manual.com>

<http://www.luxmanual.com>

<http://aubethermostatmanual.com>

Golf course search by state

<http://golfingnear.com>

Email search by domain

<http://emailbydomain.com>

Auto manuals search

<http://auto.somanuals.com>

TV manuals search

<http://tv.somanuals.com>