

STERLCO COOLING AND CIRCULATING UNIT  
SERVICE AND INSTRUCTION MANUAL  
MODEL: 7000-EX

STERLING, INC., 5200 W. Clinton Avenue, Milwaukee, Wisconsin 53223-0435

## Please note that our address and phone information has changed. Please reference this page for updated contact information.



These manuals are obsolete and are provided only for their technical information, data and capacities. Portions of these manuals detailing procedures or precautions in the operation, inspection, maintenance and repair of the products may be inadequate, inaccurate, and/or incomplete and shouldn't be relied upon. Please contact the ACS Group for more current information about these manuals and their warnings and precautions.

### Parts and Service Department

The ACS Customer Service Group will provide your company with genuine OEM quality parts manufactured to engineering design specifications, which will maximize your equipment's performance and efficiency. To assist in expediting your phone or fax order, please have the model and serial number of your unit when you contact us. A customer replacement parts list is included in this manual for your convenience. ACS welcomes inquiries on all your parts needs and is dedicated to providing excellent customer service.

#### For immediate assistance, please contact:

- North, Central and South America, 8am – 5pm CST +1 (800) 483-3919 for drying, conveying, heating and cooling and automation. For size reduction: +1 (800) 229-2919.  
North America, emergencies after 5pm CST (847) 439-5855  
**North America email: [acsuscanadacustserv@corpemail.com](mailto:acsuscanadacustserv@corpemail.com)**
- Mexico, Central & South America  
**Email: [acslatinamericacustserv@corpemail.com](mailto:acslatinamericacustserv@corpemail.com)**
- Europe, Middle East & Africa +48 22 390 9720  
**Email: [acseuropecustserv@corpemail.com](mailto:acseuropecustserv@corpemail.com)**
- India +91 21 35329112  
**Email: [acsindiacustserv@corpemail.com](mailto:acsindiacustserv@corpemail.com)**
- Asia/Australia +86 512 8717 1919  
**Email: [acsasiacustserv@corpemail.com](mailto:acsasiacustserv@corpemail.com)**

### Sales and Contracting Department

Our products are sold by a worldwide network of independent sales representatives. Contact our Sales Department for the name of the sales representative nearest you.

Let us install your system. The Contract Department offers any or all of these services: project planning; system packages including drawings; equipment, labor, and construction materials; and union or non-union installations.

#### For assistance with your sales or system contracting needs please Call:

North, Central and South America +1 (262) 641-8600 or +1 (847) 273-7700 Monday–Friday, 8am–5pm CST

Europe/Middle East/Africa +48 22 390 9720

India +91 21 35329112

Asia/Australia +86 512 8717 1919

#### Facilities:

ACS offers facilities around the world to service you no matter where you are located. For more information, please visit us at [www.acscorporate.com](http://www.acscorporate.com)

United States:

#### ACS Schaumburg – Corporate Offices

1100 E. Woodfield Road  
Suite 588  
Schaumburg, IL 60173  
Phone: + 1 847 273 7700  
Fax: + 1 847 273 7804

#### ACS New Berlin – Manufacturing Facility

2900 S. 160<sup>th</sup> Street  
New Berlin, WI 53151  
Phone : +1 262 641 8600  
Fax: + 1 262 641 8653

Asia/Australia:

#### ACS Suzhou

109 Xingpu Road SIP  
Suzhou, China 215126  
Phone: + 86 8717 1919  
Fax: +86 512 8717 1916

Europe/Middle East/Africa:

#### ACS Warsaw

Ul. Działkowa 115  
02-234 Warszawa  
Phone: + 48 22 390 9720  
Fax: +48 22 390 9724

India

#### ACS India

Gat No. 191/1, Sandbhor Complex  
Mhalunge, Chakan, Tal Khed,  
Dist. Pune 410501, India  
Phone: +91 21 35329112  
Fax: + 91 20 40147576

DWG. NO. A682-07139

ADDED CHECK  
VALVE ON RETURN  
4-30-82 CRL

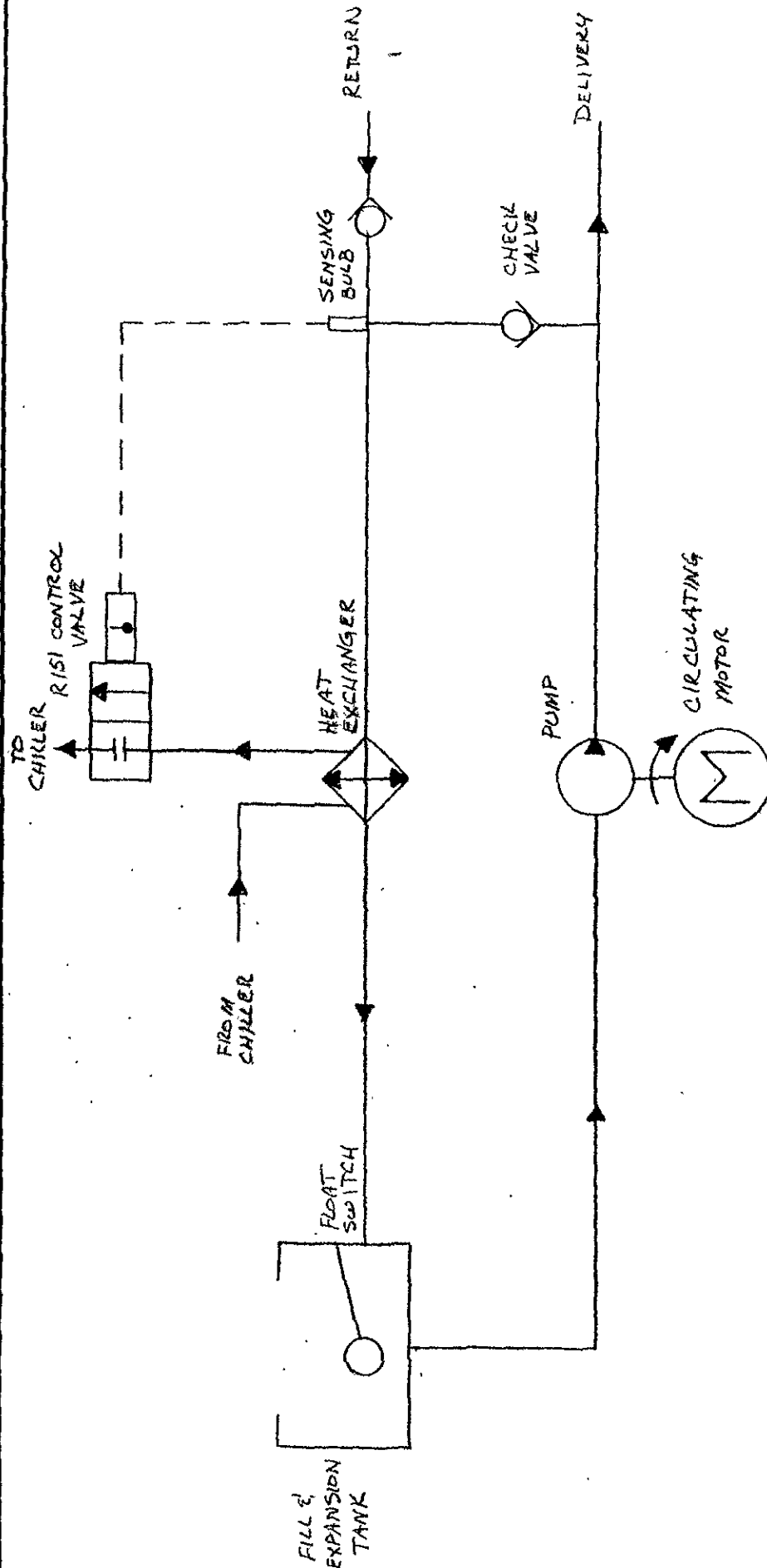

USED ON: 7000-EX

STERLING, INC.  
MILWAUKEE, WIS.

TITLE  
Flow SCHEMATIC

DR. DK

CH'K.

DATE  
4-12-82

SCALE  
N.T.S.

DRG. NO.  
A682-07139

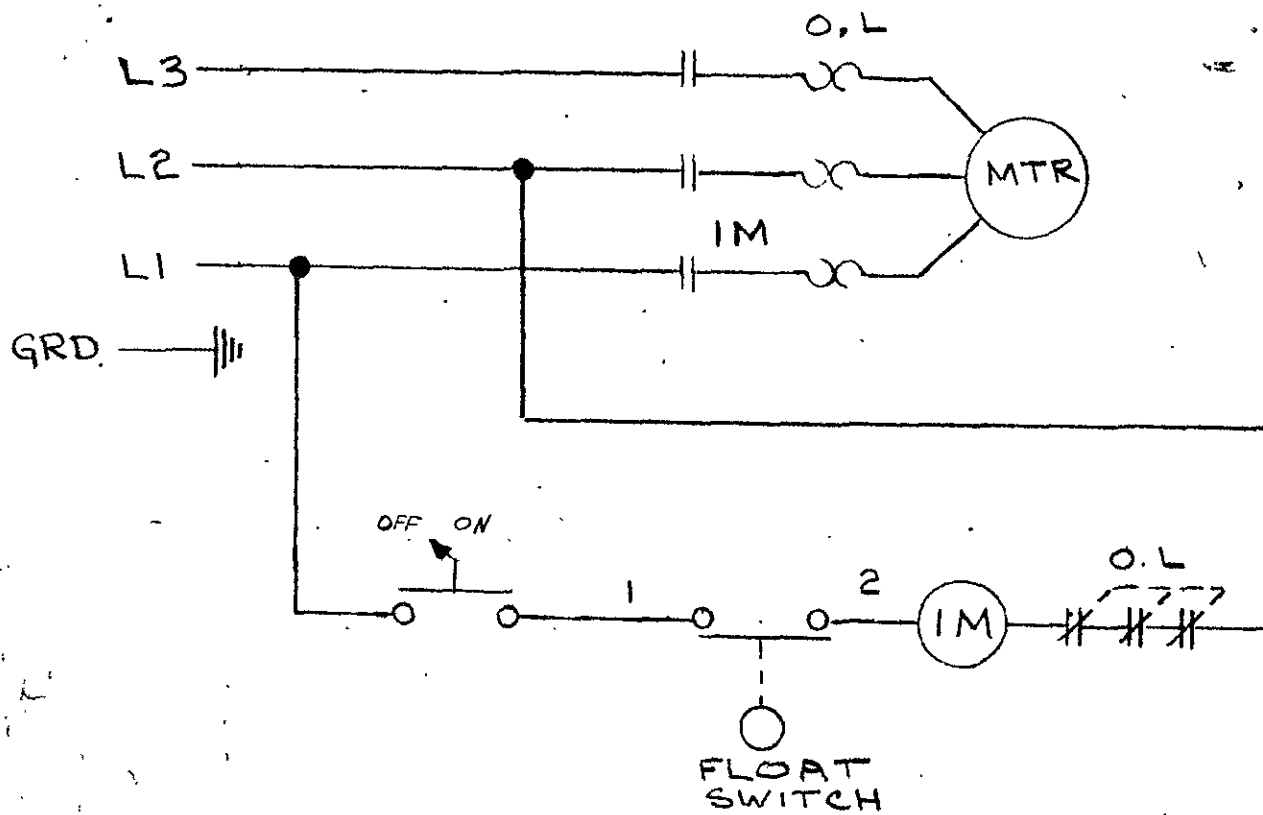

REPRO. OF A 684-00007

DR. C. J. C.	DATE 4-12	SCALE 1/2"	DRG. NO. 187 07.00
--------------	-----------	------------	--------------------

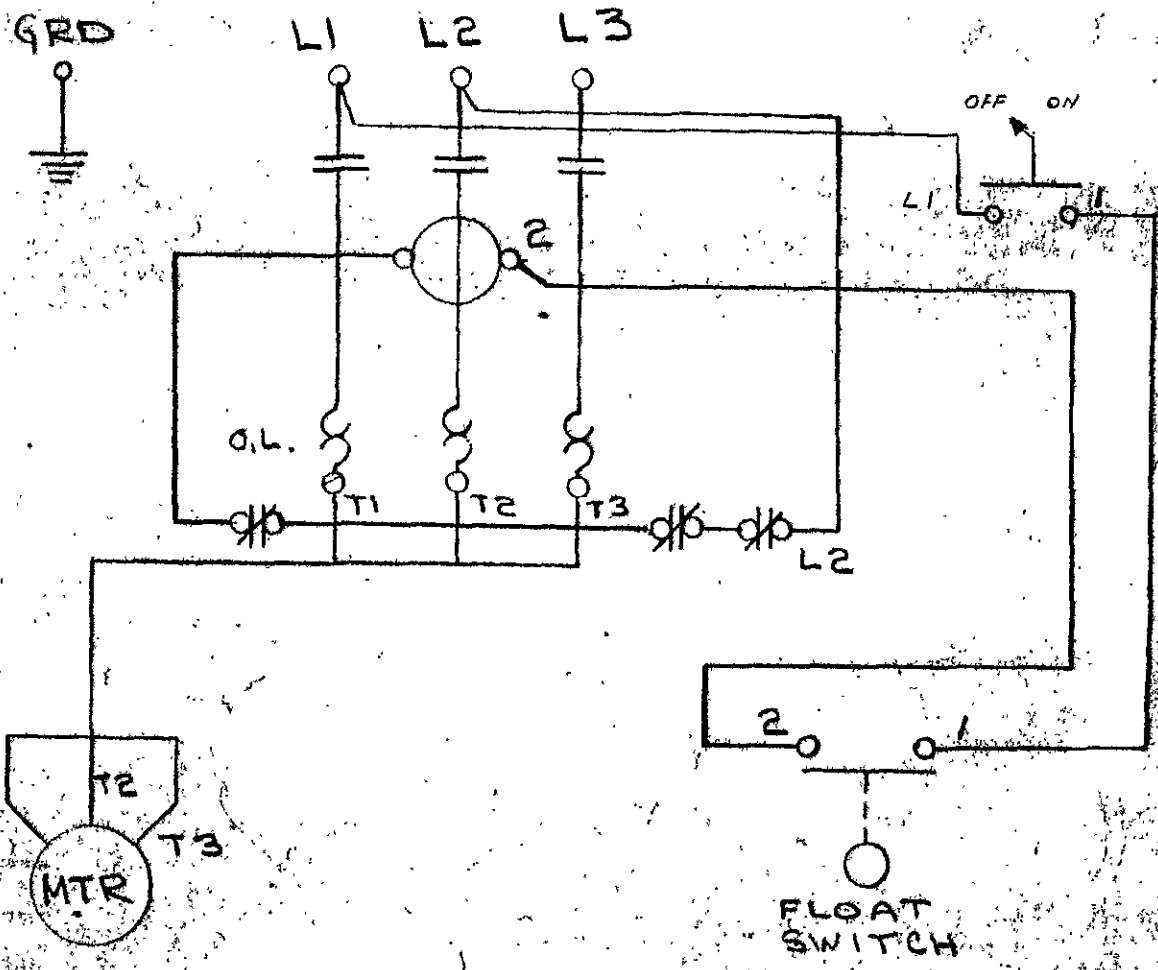

TITLE 7000-EX	DATE 1-16-68	SCALE 1/2"	DRG. NO. 187 07.00
---------------	--------------	------------	--------------------

DWG. NO. A682507180

## INSTALLATION

### ELECTRICAL CONNECTION

The nameplate of the unit will indicate the electrical rating and voltage requirement. Before making the electrical connection, be sure that the pump switch is off. To prevent accidents, the unit should be positively grounded before the power is turned on.

For those units wired for single phase operation, the pump rotation will always be correct. All 3-phase units should have motor rotation checked when the unit is installed.

### CIRCULATING CONNECTIONS

The circulating connections, marked delivery and return have 1-1/2" N.P.T. connections. If circulating lines are reasonably short, 1-1/4" pipe or hose will give good circulation. If they must be more than ten or fifteen feet long 1-1/2" pipe or hose should be used.

If two or more branches are to be fed by the unit, run a single large line from the unit to a point near the mold or other device being controlled, so that the smaller branches can be as short as possible.

Large hoses or piping and large passages in the mold or device being controlled will provide faster water circulation and consequently more accurate and sensitive control and more effective and even heating or cooling. Avoid couplings and fittings having small openings which may restrict flow, especially many types of quick-acting compressed air fittings which not only have extremely small openings but also leak when subjected to water pressure. This is very important! Small hoses, small passages in the equipment being controlled, small couplings, or anything else which slows up the circulation of the water will make the unit respond too slowly to adjustments or changes in conditions. As a result, it will take too long, when starting up, to set the controls for the desired temperature. In extreme cases poor circulation may make the unit seem to behave erratically or fail to hold temperatures steady.

Where hoses are used in circulating lines, there are many types which are large enough, flexible enough, and resistant to hot water. One satisfactory brand is Goodyear "Ortac" one-braid hose.

### WATER SUPPLY CONNECTION

A source of cold water under pressure should be provided by connection at the connection marked water supply.

Water supply pressures up to about 100 pounds per square inch will not harm this unit. But if you wish to operate with a lower water pressure to avoid hose leaks, or to protect the unit against extreme pressure fluctuations, use a low-priced pressure regulator such as the Bell & Gossett No. B3.

### DRAIN CONNECTION

A hose or pipe should be run from the connection marked drain to a location where waste warm water can be disposed of. Some users prefer to have the end of this line spill into a drain at a point where the operator of the unit can observe when and how the cooling control valve is operating.

The drain connection can be made to a closed return line, if desired, as long as the back-pressure is not great enough to prevent the warm water from flowing.

Delivery and return hoses should be of sufficient size to allow for good water flow with a low total resistance to flow. Recommended hose and coupling assemblies are illustrated on the sketches on the following pages.

# INSTALLATION AND OPERATION STERLCO TEMPERATURE CONTROL VALVES

## HANDLE GENTLY!

Temperature control valves are instruments, not pipe fittings. A dent in the body or a sharp bend in the capillary may prevent them from operating. Don't use pipe wrenches. Do not subject controls to water-hammer conditions or excessive pressures.

## BULB LOCATION

This is perhaps the most important factor in good installation. The entire bulb, not just part of it, must be exposed to the fluid of which the temperature is to be controlled. In a circulating system, the bulb must be directly in the line of flow. In a tank, it must be in a representative location, not in a corner which may be warmer or cooler than the rest of the tank. The temperature at the bulb is the only one which can be controlled.

## BULB WELLS

Should be used when needed to prevent corrosion or for removing the bulb without draining the tank or system.

## VALVE LOCATION (HEATING OR DIRECT ACTING CONTROL)

In supply line close to inlet. When heating with steam, always use a Sterlco float and thermostatic trap at the condensate outlet from the heating equipment. Don't install the control valve at the condensate outlet; water-hammer or poor control may result.

## VALVE LOCATION (COOLING OR REVERSE ACTING CONTROL)

Close to the cooling equipment. Where feasible, as in a heat exchanger, valve should be in the cooling water outlet line rather than the supply line. This keeps the exchanger filled with water and prevents the control from being affected by extreme variations of cooling water temperature.

## VALVE POSITION

Preferably with adjusting screw at top but can usually be used in any other position. If possible, let capillary run downward from valve to bulb. All valve bodies have arrows showing direction of flow. If installed backward, they will be noisy or inoperative.

## CAPILLARY LOCATION

Not next to a steam line or in a cold draft. If the capillary is exposed to extreme temperatures, it may be desirable to wrap it with insulating material.

## STRAINERS

A Sterlco 20-Y or 18-Y Strainer should always be installed just ahead of each control valve to protect it from large particles of dirt. And the system must be kept free of sediment, scale, etc.

## ADJUSTMENT

Temperature adjustment, within the range of the control, is made by simply turning an adjusting screw in the direction indicated on the valve body or nameplate. Turn the screw only a little at a time, then let temperatures reach equilibrium before adjusting further.

## OPERATION

Remember that this is a modulating control. It does not alternately open wide and shut tight like an electrical control device. It opens gradually wider and wider, in relation to the difference between the actual bulb temperature and the bulb temperature at which the valve is closed. In normal operation, the control valve remains in a constant, partially open position which is automatically adjusted whenever conditions require it.

## MAINTENANCE

The only servicing normally required is to keep the control clean. The valve can be inspected and cleaned by access through the inlet and outlet, without disassembly. The bulb must not become coated with any substance which interferes with the transmission of heat.

If repairs are needed, we recommend that these controls be returned to our factory for reconditioning. Skilled workmen, with proper tools, replacement parts, and testing facilities, will do a good job more economically than it can be done in the field. These controls are simple to disassemble and assemble for a person who is familiar with them. But an inexperienced worker will sometimes damage them by incorrect handling. And usually replacement parts, which are not available in the field, will be required. If for any reason it is necessary to disassemble one of these controls, please write us for detailed assembly drawings and instructions.

If a control has to be returned for repairs, please tell us as much as possible about what appears to be wrong, and ship it "as is" without disassembling it and possibly damaging good parts. This will help us to do the best and most economical work, and to advise you how to avoid further trouble.

## TROUBLE-SHOOTING

If the control does not appear to be holding temperatures steady, or if not enough heating or cooling is obtained, first check for external conditions which may prevent the control from operating correctly. Examples are: low or fluctuating steam or water supply pressure; damaged or obstructed valves, traps, strainers or other accessories; supply piping too small; dirty bulb or poor bulb location.

If the valve will not close, check for dirt or foreign matter between disc and seat. The valve can be inspected through the inlet and outlet openings without disassembly, and can usually be cleaned out with an air hose.

If overheating results because a direct-acting (heating) valve stays open or a reverse-acting (cooling) valve stays closed regardless of the temperature at the bulb, the thermostat may have lost its fill and become inoperative. To check this, remove valve and bulb from the line, set the control at about the middle of the range, and insert the bulb in water hotter than the maximum of the range. If the direct-acting control does not close or the reverse-acting control does not open, factory repairs to the thermostat are required.

If there is a leak to the exterior of the body, some part may be loose or partially disassembled. Otherwise, a seal bellows may be damaged requiring factory replacement.

If the valve chatters, this usually means a loose or disassembled interior part. Chattering is sometimes caused by other devices near the control, and can sometimes be eliminated by changing piping arrangements, valve position, or supply pressure.

STERLING, INC., MILWAUKEE, WIS.

## HEATING APPLICATIONS

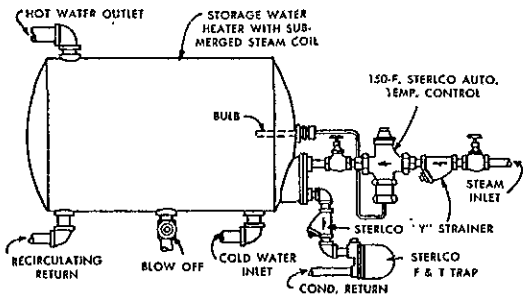

STORAGE WATER HEATER

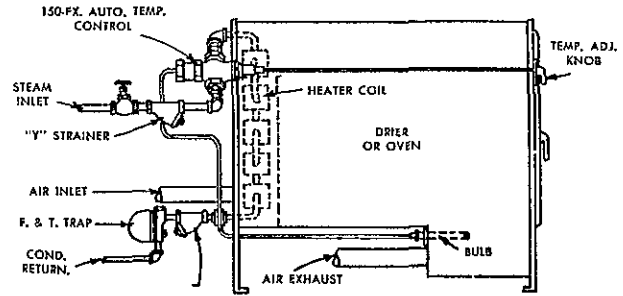

DRIER OR OVEN

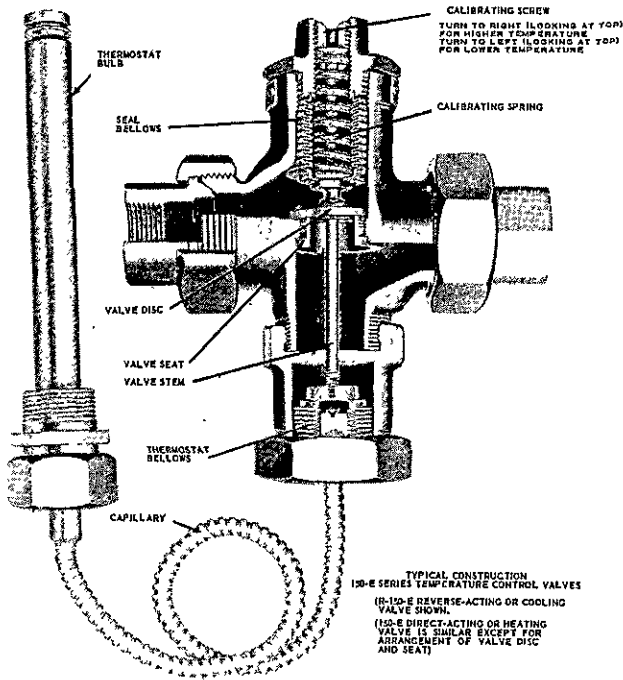

Shown above and below are only a few of the possible installations of Sterlco Temperature Control Valves.

We should be glad to give you our suggestions as to valve selection and installation at any time. Just send us a sketch of the equipment to be controlled, and specify pipe sizes, whether cooling or heating, pressure, temperature, and kind of fluid surrounding bulb, and capacity required.

## COOLING APPLICATIONS

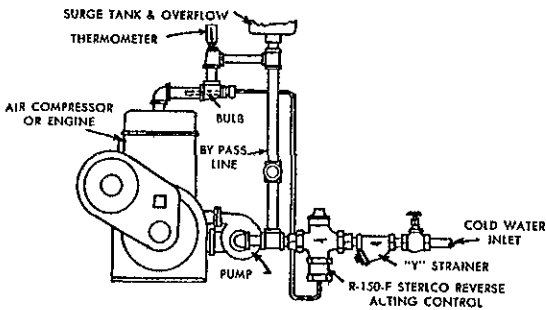

COMPRESSOR OR ENGINE

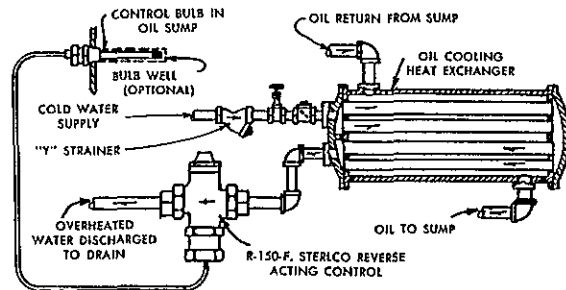

HEAT EXCHANGER



INDEX

	PAGE
INSTALLATION. . . . .	1
INSTALLATION PAGE 2 . . . . .	2
Elementary Diagram . . . . .	
Flow Diagram . . . . .	
OPERATION . . . . .	3
FORM I-4100-E1. . . . .	
Parts List-MP . . . . .	
BULLETIN 505A . . . . .	
FORM ITC. . . . .	
MOTOR BULLETIN. . . . .	
PARTS LIST. . . . .	
WARRANTY. . . . .	

MODEL: 7000-E

INDEX

FLOW SCHEMATIC . . . . .

ELEMENTARY DIAGRAM . . . . .

STERLCO PUMP AND MOTOR . . . . . I-4100-E1

PARTS LIST . . . . . #111

STERLCO CONTROL BULLETIN . . . . . 505A

INSTALLATION AND OPERATION . . . . . ITC

MOTOR BULLETIN . . . . . MFG.

SPARE PARTS LIST . . . . .

WARRANTY . . . . .

STERLING, INC.  
PARTS LIST (B-G)  
STERLCO PUMP 1 to 3 HP

<u>ITEM</u>	<u>PART NO.</u>	<u>DESCRIPTION</u>
O	001-05915	Motor Screw, (4) req'd
P	542-10404	Water Slinger
Q	B-615-00001	Bracket
R	081-00024	Rotary Seal Assembly
S		Impeller ~ specify part no. and dia. (See pump nameplate)
T	525-00001	Lock Washer
U	535-00001	Impeller nut
V	545-00002	Housing Gasket
W-A	615-00003	Threaded Inlet Casting;
W-B	615-00002	Tank Inlet Casting
X-A	001-05915	Pump Screw for pump w/threaded suction (8) req'd
X-B	001-05915	Pump Screw for pump w/tank suction (6) req'd
X-B	001-05923	Pump Screw for pump w/tank suction (7) req'd (Above parts illustrated on Form MP-1)
	M-160-00005	Motor Drip Cover (**)
	N-720-09003	Electric Motor 1 HP - 3/60/230-460 V open (#)
	N-720-09009	Electric Motor 1 HP - 3/60/230-460V TEFC (#ç)
	N-720-09004	Electric Motor 1-1/2 HP - 3/60/230-460V open (#)
	N-720-09010	Electric Motor 1-1/2 HP - 3/60/230-460V TEFC (#ç)
	N-720-09005	Electric Motor 2 HP - 3/60/230-460 V open (#)
	N-720-09011	Electric Motor 2 HP -3/60/230-460V TEFC (#ç)
	N-720-09285	Electric Motor 3 HP - 3/60/230-460V open (#)
	N-720-09012	Electric Motor 3 HP - 3/60/230-460V TEFC (#ç)

\*\* Used only on drip proof motors

\* State Motor Manufacturer

# State Motor Manufacturer if preferred

ç State special specification (i.e. 7EQ-Spec., 7E-Spec., etc.)

Sterling part numbers apply to non-special motors. Consult Parts List in your unit manual for specific motor requirements.

STERLING, INC., 5200 West Clinton Ave., Milwaukee, Wisconsin 53223-0435

Phone: (414) 354-0970

Telex: 2-6805

P.O. Box 23435

# REPLACING ROTARY SEAL ASSEMBLY ON STERLCO PUMP AND MOTOR

## PARTS

**A. Drip Cover**  
**B. Motor**  
**C. Water Slinger**  
**D. Motor Screws**

**E. Bracket**  
**F. Prime Cock**  
**G. Pump Screws**  
**H. Rotary Seal Assembly**

**I. Impeller**  
**J. Impeller Screw**  
**K. Housing Gasket**  
**L. Volute - A or B**

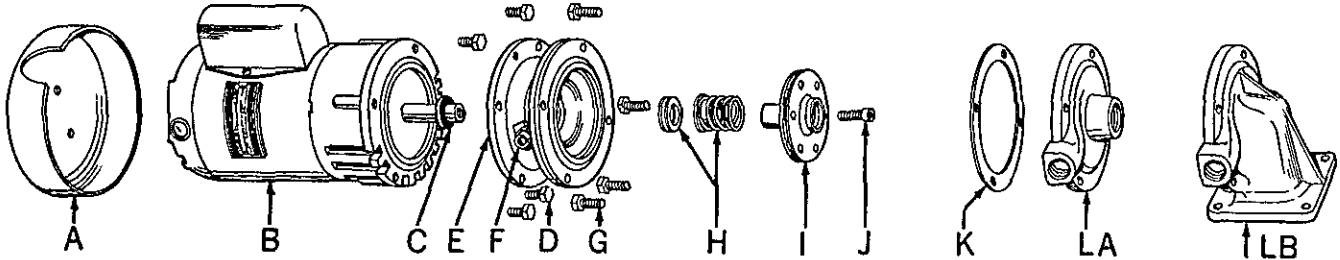

Step No. 1 — Dis-assembling (Removal of old seal assembly)

Step No. 2 — Re-assembly (Installation of new seal assembly)

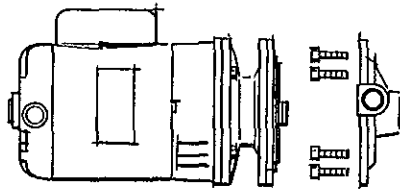

a) Remove volute from motor bracket and impeller assembly by removing pump screws.

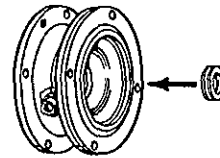

f) Coat outside edge of new seat with 3% detergent solution and slip it into the bracket. Press into bracket with thumbs or wooden dowel. Handle seat carefully so seating surfaces are not scratched or chipped . . . be sure it is squarely seated.

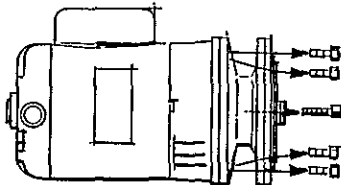

b) Remove impeller screw and motor screws. (Note: opposite end of motor shaft is fitted with screw driver slot to hold shaft securely while impeller screw is being removed. Drip cover must be removed to get at screw-driver slot).

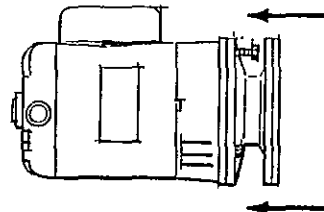

g) Remount bracket on motor.

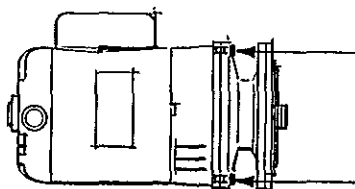

c) Insert two of the pump screws into the two threaded holes in the bracket. Tighten them slowly and evenly to force the impeller and bracket off the shaft. Do not pry the impeller or bracket!

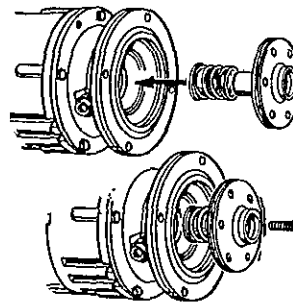

h) Lubricate impeller hub with 3% detergent solution . . . slip new bellows and spring onto impeller hub. Be sure bellows slides freely on impeller hub.

i) Replace impeller on motor shaft extension and secure with impeller screw. Hold shaft with screw driver slot while tightening screw.

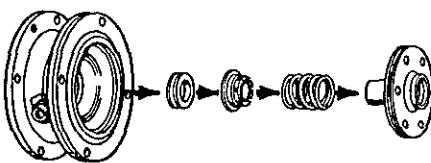

d) Remove old seal parts from impeller hub and bracket. Be sure water slinger is in place.

e) Clean impeller hub thoroughly . . . remove all loose particles of dirt, grease, etc. Use fine emery cloth if necessary. Also clean the recess in the bracket so the new seat will fit perfectly. Remove all particles and dirt on gasket surfaces of the two castings.

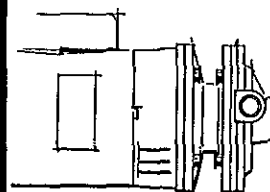

j) Replace volute onto bracket, using new housing gasket. Use one gasket for condensate pump and for temperature control units. Secure with pump screws. Be certain gasket is seated properly.

**NOTE:** When ordering parts please indicate pump model number and serial number.

**STERLING, INC.** 5200 W. Clinton Ave., Milwaukee, Wisconsin 53223



**STERLCO**

SELF-MODULATING  
**TEMPERATURE  
CONTROL VALVES**

STERLCO COOLING AND CIRCULATING UNIT

SERVICE AND INSTRUCTION MANUAL

MODEL 7000-E

STERLING, INC.  
5200 W. Clinton Ave.  
P.O. Box 23435  
Milwaukee, WI 53223-0435

PARTS LIST  
7000EX 0401  
August 5, 1988

MODEL 7000-EX

<u>PARTS NO.</u>	<u>DESCRIPTION</u>
106-00104	Heat Exchanger 40 Sq. Ft.
037-00047	Gauge, Sight
720-09005	Motor 2 HP
605-00091-02	Pump & Motor Assembly Complete 2 HP
726-00042-02	Starter, Motor G.E.
734-00012	Switch, Float
044-00013	Value, Check 1/2"
R152-02-C030	Value, Cooling 85/125

NOTE: Please give Model & Serial No's. when ordering parts. Part No's. are listed as a guide, but many units have special parts or features not covered by this list.

STERLING, INC., 5200 W. Clinton Avenue, Milwaukee, Wisconsin  
53223-0435

Phone: (414) 354-0970 Telex 2-6805

## Free Manuals Download Website

<http://myh66.com>

<http://usermanuals.us>

<http://www.somanuals.com>

<http://www.4manuals.cc>

<http://www.manual-lib.com>

<http://www.404manual.com>

<http://www.luxmanual.com>

<http://aubethermostatmanual.com>

Golf course search by state

<http://golfingnear.com>

Email search by domain

<http://emailbydomain.com>

Auto manuals search

<http://auto.somanuals.com>

TV manuals search

<http://tv.somanuals.com>