



Futura F144 and F131 w/ Blender

OWNER'S MANUAL

Manual No. 513603-1 March 2005

Need Parts or Service?

We stock the parts you need.

Our Technicians are factory trained and are certified in the Stoelting Technicare program.

CALL

Distributor: _____

Phone No.: _____

(fill in or affix label)

Model No.: _____

Serial No.: _____

Purchase Date: _____

Start-Up Date: _____

**Owner's Manual
For Futura F144/SF144
Stoelting Counter Model Gravity Freezer
Soft Serve/Shake**

This manual provides basic information about the freezer. Instructions and suggestions are given covering its operation and care.

The illustrations and specifications are not binding in detail. We reserve the right to make changes to the freezer without notice, and without incurring any obligation to modify or provide new parts for freezers built prior to date of change.

DO NOT ATTEMPT to operate the freezer until instructions and safety precautions in this manual are read completely and are thoroughly understood. If problems develop or questions arise in connection with installation, operation, or servicing of the freezer, contact the company at the following location:

**STOELTING, LLC
502 Hwy. 67
Kiel, WI 53042**

Ph: 920-894-2293

Fax: 920-894-7029

A Few Words About Safety

Safety Information

Read and understand the entire manual before operating or maintaining Stoelting equipment.

This Owner's Manual provides the operator with information for the safe operation and maintenance of Stoelting equipment. As with any machine, there are hazards associated with their operation. For this reason safety is emphasized throughout the manual. To highlight specific safety information, the following safety definitions are provided to assist the reader.

The purpose of safety symbols is to attract your attention to possible dangers. The safety symbols, and their explanations, deserve your careful attention and understanding. The safety warnings do not by themselves eliminate any danger. The instructions or warnings they give are not substitutes for proper accident prevention measures.

If you need to replace a part, use genuine Stoelting parts with the correct part number or an equivalent part. We strongly recommend that you do not use replacement parts of inferior quality.



Safety Alert Symbol:

This symbol Indicates danger, warning or caution. Attention is required in order to avoid serious personal injury. The message that follows the symbol contains important information about safety.

Signal Word:

Signal words are distinctive words used throughout this manual that alert the reader to the existence and relative degree of a hazard.



The signal word "WARNING" indicates a potentially hazardous situation, which, if not avoided, may result in death or serious injury and equipment/property damage.



The signal word "CAUTION" indicates a potentially hazardous situation, which, if not avoided, may result in minor or moderate injury and equipment/property damage.

CAUTION

The signal word "CAUTION" not preceded by the safety alert symbol indicates a potentially hazardous situation, which, if not avoided, may result in equipment/property damage.

NOTICE

The signal word "NOTICE" indicates information or procedures that relate directly or indirectly to the safety or personnel or equipment/property.

TABLE OF CONTENTS

SECTION 1 - SPECIFICATIONS	1
1.1 Description	1
1.2 Specifications	2
SECTION 2 - INSTALLATION INSTRUCTIONS	3
2.1 Safety Precautions	3
2.2 Shipment and Transit	4
2.3 Freezer Installation	4
2.4 Floor Stand Installation	5
2.5 Installing Permanent Wiring	5
SECTION 3 - INITIAL SET-UP AND OPERATION	7
3.1 Operator's Safety Precautions	7
3.2 Operating Controls and Indicators	7
3.3 Sanitizing	9
3.4 Freeze Down and Operation	10
3.5 Mix Information	11
3.6 Removing Mix from Freezer	11
3.7 Cleaning the Freezer	12
3.8 Disassembly of Freezer Parts	12
3.9 Cleaning the Freezer Parts	14
3.10 Sanitize Freezer and Freezer Parts	14
3.11 Assembly of Freezer	14
3.12 Routine Cleaning	16
3.13 Preventative Maintenance	16
3.14 Extended Storage	19
SECTION 4 - TROUBLESHOOTING	21
4.1 Troubleshooting Chart	21
4.2 Error Code System	23
SECTION 5 - REPLACEMENT PARTS	25
5.1 How to Order Parts	25
WARRANTY	27

LIST OF ILLUSTRATIONS

Fig.	Description	Page
1	Model Endura/Futura 131G Freezer	1
2	Specifications	1
3	Warning Label Locations	3
4	Space and Ventilation Requirements	4
5	Installing Tray and Insert	4
6	Power Cord	4
7	Floor Stand	5
8	Power Cord Connection	5
9	Controls	7
10	Mix Inlet Regulator	9
11	Sanitizing Procedure	9
12	Clean Control	9
13	Sanitizing Hopper	10
14	Spigot Opened and Solution Draining	10
15	Sanitizing Agitator Shaft	10
16	Dispensing Product	11
17	Removing Mix Inlet Regulator	11
18	Draining Mix	12
19	Cleaning Agitator Shaft	12
20	Auger Flight Wear and Front Auger Support Wear	13
21	Removing Front Door	13
22	Front Door Disassembly	13
23	Removing Agitator From Shaft	13
24	Removing Auger Support	13
25	Removing O-ring	14
26	Exploded View of Auger	15
27	Exploded View of Front Door	15
28	Install Mix Inlet Regulators	15
29	Condenser and Filter	18
30	Cleaning Condenser	18
31	Spigot, Front Door and Auger Assembly	26

SECTION 1 SPECIFICATIONS

1.1 DESCRIPTION

The Stoelting Futura F144 and F131 w/Blender countertop combination shake/softserve freezers are gravity fed. The freezers are equipped with fully automatic controls to provide uniform product. The freezer is designed to operate with almost any type of commercial soft serve and shake mixes available, including ice milk, ice cream, yogurt, and frozen dietary desserts.

The F144 series freezers allow the operator to dispense outstanding soft serve from the left spigot, and thick creamy shakes from the right spigot, with the convenience and cost of one unit. The freezer is designed to be used with both barrels in operation. If you desire to use one barrel only, the freezer must be cleaned, sanitized and filled with fresh mix daily. The F131 freezer includes a blender for mixing fruit and berries into the dairy product for making smoothies. For more information call your authorized Stoelting Serviceperson.

This manual is designed to assist qualified service personnel and operators in the installation, operation and maintenance of the Stoelting Model Futura 144 gravity freezer.



Figure 1. Model Futura 144/F131 Freezer
(F131 w/ blender shown mounted on
the optional floor stand.)

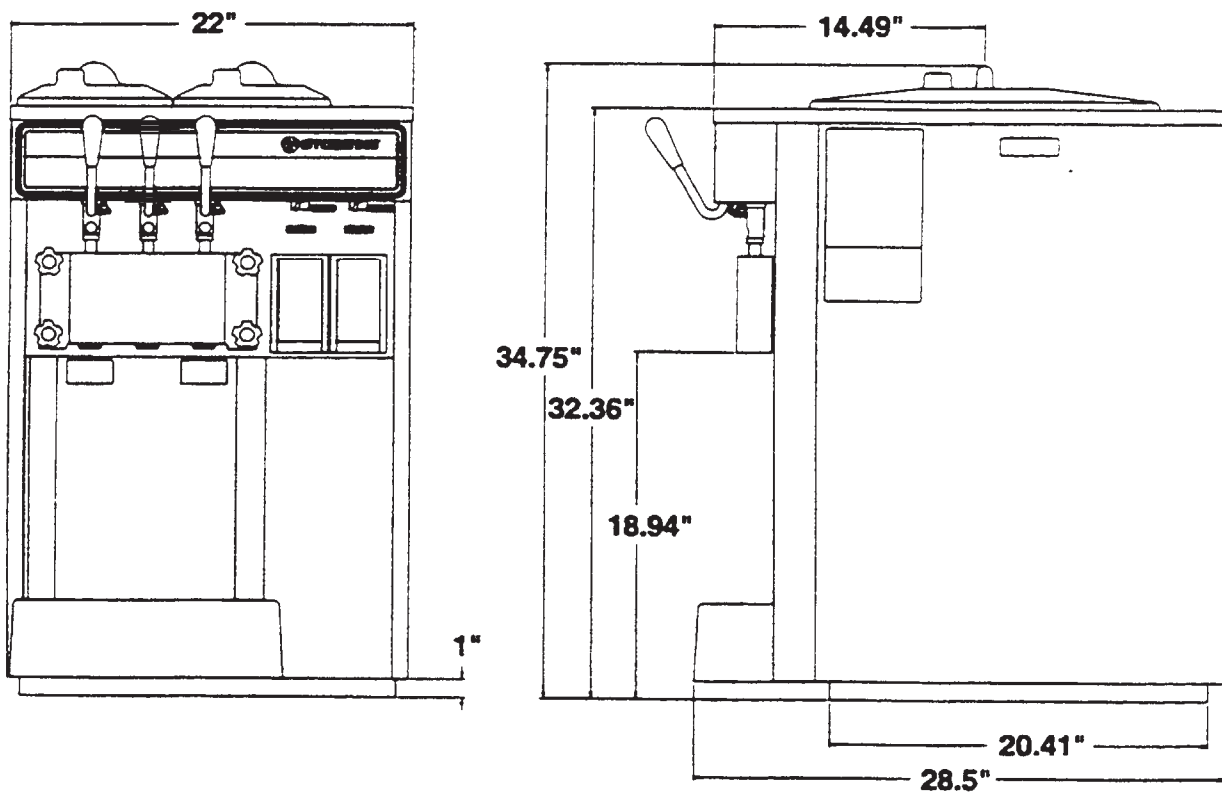

Figure 2. Specifications

1.2 SPECIFICATIONS
MODEL FUTURA 144
COUNTERTOP COMBINATION SHAKE/SOFTSERVE
GRAVITY FREEZER

Dimensions:

Freezer: 22" (56 cm) wide x 28" (72 cm) deep x 34.75" (88 cm) high

Crated: 28" (71 cm) wide x 35 1/2" (89.4 cm) deep x 40.3" (102.4 cm) high

Weight:

Freezer: 385 lbs. (174.6 kg) Crated: 470 lbs. (213.2 kg)

Electrical:

Approximately 11 total running Amps, 20 Amp. maximum fuse or circuit breakers. NEMA 6-20P power cord provided.

Automatic safeguard circuit built into electronic control - protects major freezer components under normal operating conditions.

Refrigerant:

R404a

Compressor:

12,000 B.T.U.H./hr.

Drive Motor:

(2) 3/4 H.P.

Cooling

Air cooled requires minimum 3" air clearance on right and left hand side and rear. Minimum 10" top clearance

Freezing Cylinder Volume

Two cylinders, .85 gallon, 3.4 Quarts (3,22 liters)

Hopper

2 each, 3 Gallons (11.35 liters) each refrigerated and insulated.

SECTION 2 INSTALLATION INSTRUCTIONS

2.1 SAFETY PRECAUTIONS

Do not attempt to operate the freezer until the safety precautions and operating instructions in this manual are read completely and are thoroughly understood.

Take notice of all warning labels on the freezer (Fig. 3). The labels have been put there to help maintain a safe working environment. The labels have been designed to withstand washing and cleaning. All labels must remain legible for the life of the freezer.

Labels should be checked periodically to be sure they can be recognized as warning labels.

If danger, warning or caution labels are needed, indicate the part number, type of label, location of label, and quantity required along with your address and mail to:

STOELTING, INC.
ATTENTION: Customer Service
502 HWY 67
Kiel, Wisconsin 53042-1600

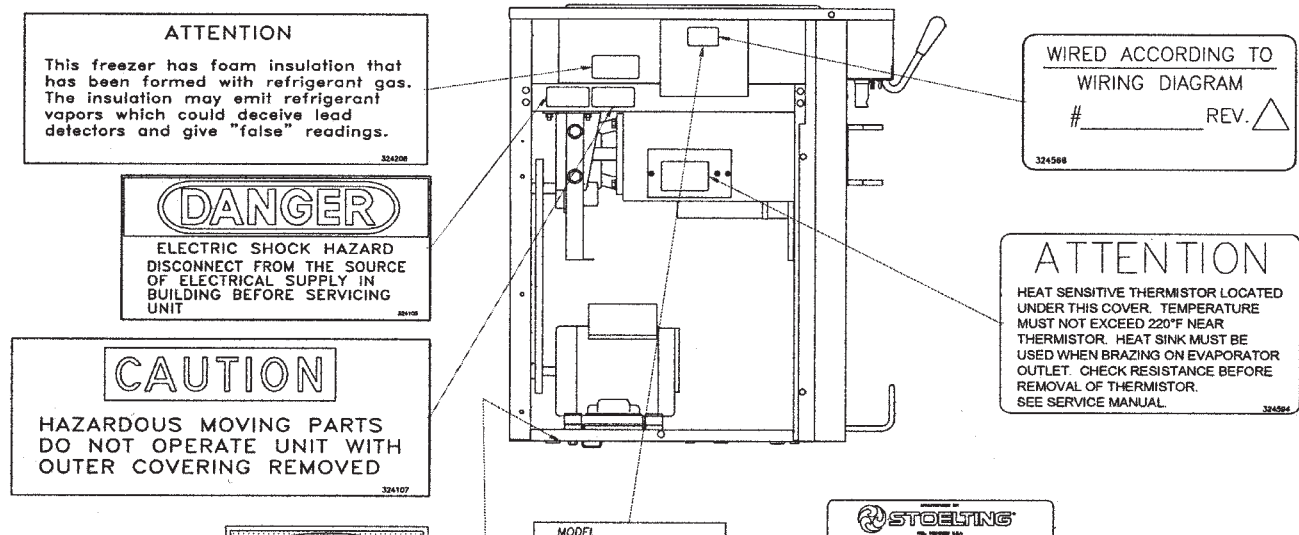

Fig. 3. Warning Label Locations

2.2 SHIPMENT AND TRANSIT

The freezer has been assembled, operated and inspected at the factory. Upon arrival at the final destination, the complete freezer must be checked for any damage which may have occurred during transit.

With the method of packaging used, the freezer should arrive in excellent condition. **THE CARRIER IS RESPONSIBLE FOR ALL DAMAGE IN TRANSIT, WHETHER VISIBLE OR CONCEALED.** Do not pay the freight bill until the freezer has been checked for damage. Have the carrier note any visible damage on the freight bill.

If concealed damaged and/or shortage is found later, advise the carrier within 10 days and request inspection. The customer must place claim for damages and/or shortages in shipment with the carrier. **Stoelting, Inc. cannot make any claims against the carrier.**

2.3 FREEZER INSTALLATION

Installation of the freezer involves moving the freezer close to its permanent location, removing all crating, setting in place, assembling parts, and cleaning.

- A. Uncrate the freezer.
- B. Accurate leveling is necessary for correct drainage of freezer barrel and to insure correct overrun. Place a spirit level on top of the freezer at each corner to check for level condition. If adjustment is necessary, level the freezer by turning the bottom part of each leg in or out. Then separate freezer base gasket and install with the seam to the back and the flat to the bottom.
- C. Air cooled freezers require correct ventilation. The right side of the freezer is the air intake and **must** have a 3" (7.5cm) clearance. Air discharges out of the left side of the unit and must have 3" (7.5cm) clearance. **Do not** obstruct the intake or discharge (Fig. 4).



Fig. 4. Space and Ventilation Requirements

CAUTION
Failure to provide adequate ventilation will void Warranty.

- D. Place the OFF-ON switch in the OFF position. See Figure 8.
- E. Install the drip trays, drain trays, covers and other miscellaneous parts on the freezer. (Fig. 5)



Figure 5. Installing Trays and Inserts (F131 w/ blender shown)

- F. Connect the power cord. The plug is designed for 208 or 230 volt/20 amp duty. Check the nameplate on your freezer for proper supply. The unit must be connected to a properly grounded receptacle. The electrical cord furnished as part of the freezer has a three prong grounding type plug (Fig. 6). The use of an extension cord is not recommended. If one must be used, use one with a wire size 12 gauge or heavier with a ground wire. Do not use an adaptor to get around grounding requirement.

 WARNING
Do not alter or deform electrical plug in any way. Altering the plug to fit into an outlet of different configuration may cause fire, risk of electrical shock, product damage and will void the warranty.



Figure 6. Power Cord

2.4 FLOOR STAND INSTALLATION

To install the F144 on the floor stand, follow the steps outlined below.

1. Uncrate the floor stand and place in an upright position.

NOTE

Detailed instructions are included with each floor stand.

2. Place a spirit level across the top of the stand to check for level condition, side to side and front to back. If adjustment is necessary, level the stand by turning the bottom part of each caster in or out, then tighten the lock nut, and lock caster.
3. Remove the four legs from the freezer and replace with the four leg adapters provided. Adapters must be fully tightened to the freezer.
4. Place the F144 freezer on the floor stand with the front of the freezer to the door end of the stand. Secure the freezer to the stand with the nuts and lock washers provided. Then separate freezer base gasket and install the seam to the back and the flat to the bottom (Fig. 7).



Fig. 7. Floor Stand

2.5 INSTALLING PERMANENT WIRING



WARNING

High voltage will shock, burn or cause death. Turn off and lock out main power disconnect before proceeding with installation. Do not operate machine with cabinet panels removed.

Electrical materials, arrangement and grounding must conform with national and local electrical codes. If permanent wiring is required by local codes, the following procedure must be performed:

- A. Remove the back panel.
- B. Disconnect the wires from the terminal block. Disconnect the green ground wire from the grounding stud.

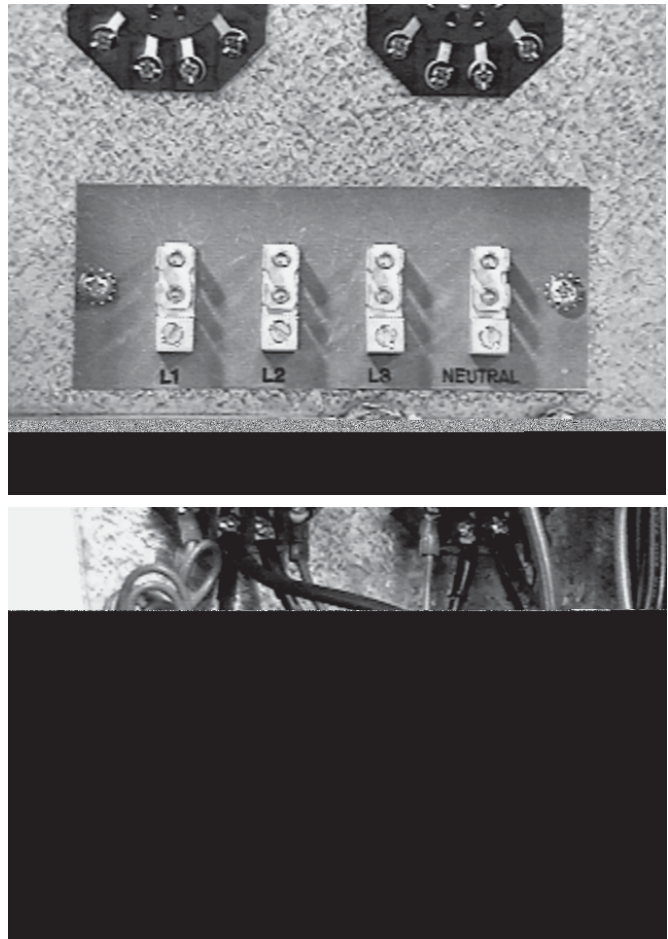

Figure 8. Power Cord Connection

- C. Remove the power cord.
- D. Install permanent wiring according to local code.
- E. Replace the back panel.

SECTION 3 INITIAL SET-UP AND OPERATION

3.1 OPERATOR'S SAFETY PRECAUTIONS

SAFE OPERATION IS NOT AN ACCIDENT; Observe these rules:

- A. **Know the freezer.** Read and understand the Operating Instructions.
- B. **Notice all warning labels on the freezer.**
- C. **Wear proper clothing.** Avoid loose fitting garments, and remove watches, rings or jewelry which could cause a serious accident.
- D. **Maintain a clean work area.** Avoid accidents by cleaning up the area and keeping it clean.
- E. **Stay alert at all times.** Know which switch, push button or control you are about to use and what effect it is going to have.
- F. **Disconnect electrical cord for maintenance.** Never attempt to repair or perform maintenance on the freezer until the main electrical power has been disconnected.

- G. **Do not operate under unsafe operating conditions.** Never operate the freezer if unusual or excessive noise or vibration occurs.

3.2 OPERATION CONTROLS AND INDICATORS

Before operating the freezer, it is required that the operator know the function of each operating control. Refer to Figure 9 for the location of the operating controls on the freezer.

A. SPIGOT SWITCH

The SPIGOT switch will automatically actuate the auger drive and refrigeration systems when the spigot is opened to dispense product. When the spigot is closed, the drive motor and compressor will remain "on" until the product in the barrel reaches the proper consistency.

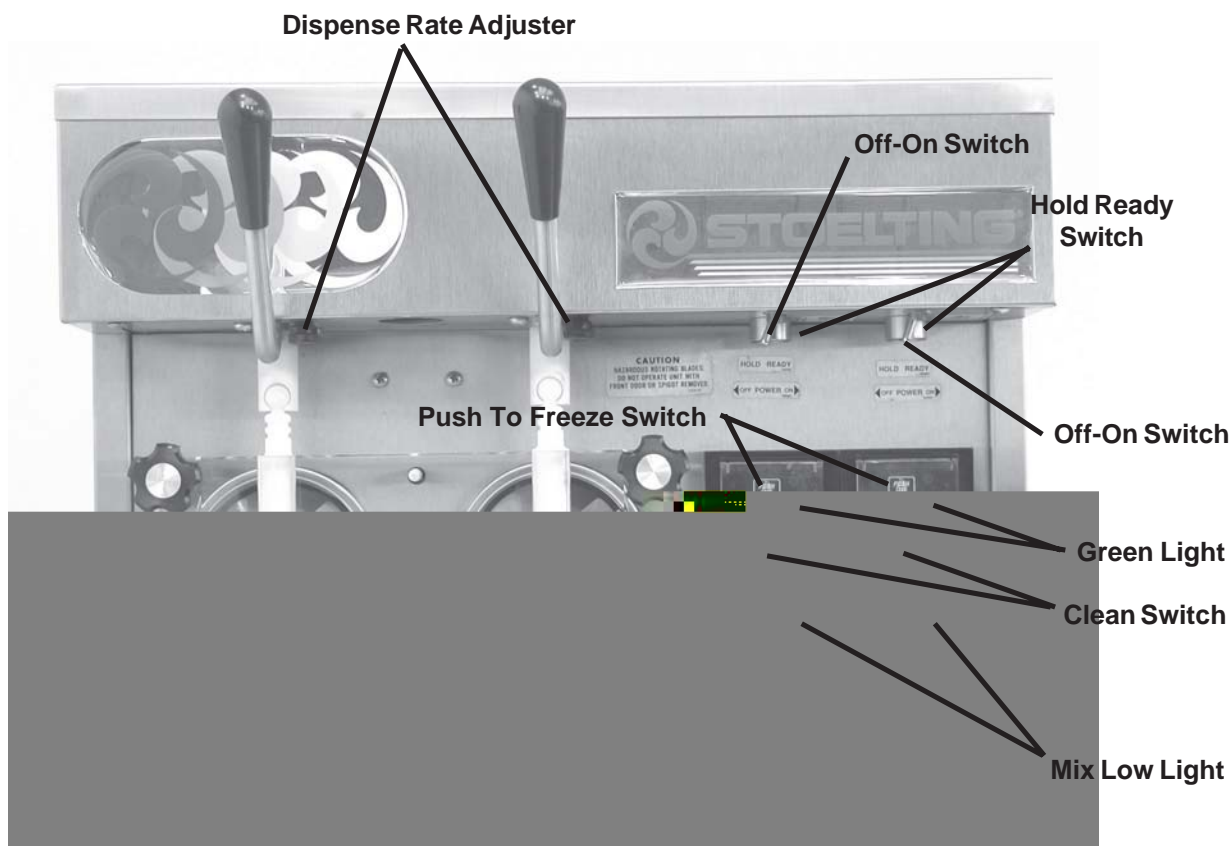

Figure 9. Controls



WARNING

High voltage will shock, burn or cause death. The OFF-ON switch must be placed in the OFF position prior to disassembling for cleaning or servicing. Do not operate machine with cabinet panels removed.

B. OFF-ON SWITCH

The OFF-ON switch is a two position toggle switch used to supply power to the control circuit. When the switch is in the OFF position, nothing will turn. When the switch is in the ON position, the freezer can be run in the freezing mode or cleaning mode. The freezer will be in the idle mode until a switch is activated.

C. PUSH TO FREEZE SWITCH

The PUSH TO FREEZE switch is a "snap" switch used to start the freezing cycle. During initial freeze down, the OFF-ON switch is placed in the ON position. Then the PUSH TO FREEZE switch is pressed until the drive motor and compressor come "ON".

NOTE

After the auger drive motor starts, there is a 3 second delay before the compressor starts.

During the normal operation, the red PUSH TO FREEZE switch light will illuminate after the freezer has been idle for the preset cycles. Before drawing product, press the red PUSH TO FREEZE switch if it is illuminated. Wait until the green light is illuminated before dispensing.

NOTE

If the freezer shuts off and the PUSH TO FREEZE light flashes, you have an error condition. Turn the OFF-ON switch to the OFF position, correct the problem and turn the freezer back on. (See Troubleshooting.)

D. GREEN LIGHT

The green light is used to indicate that the product has reached the proper consistency and is ready to be dispensed. The light begins to flash at 98% of consistency.

NOTE

If the PUSH TO FREEZE red light is illuminated, push the PUSH TO FREEZE switch and wait until the green light illuminates before dispensing.

E. CLEAN SWITCH

The CLEAN switch is a "snap" switch. When the switch is pushed the refrigeration system will be OFF and the auger will rotate for cleaning. When the switch is pushed again, the auger will stop and the CLEAN light will flash indicating the freezer is in the CLEAN mode. To exit the CLEAN mode turn the OFF-ON switch to the OFF position. If the freezer is left in CLEAN for more than 30 minutes or is pushed three times in ten seconds, it will go in error.

F. DRIVE MOTOR OVERLOAD

The internal drive motor overload will trip if the drive motor is overloaded. It will reset after approximately 10-12 minutes. If the drive motor continues to trip, refer to Section 4-Troubleshooting.

G. RED MIX LOW LENS

The red MIX LOW light is designed to alert the operator to a low mix condition. The lens will illuminate with approximately one gallon of mix in the hopper. When the MIX LOW lens is lit, refill hopper immediately.

NOTE

Failure to immediately refill hopper may result in operational problems.

H. HOLD READY SWITCH

The HOLD READY switch is a push button switch. When pushed in and held for 5 seconds, the hold ready mode will be activated. The product will remain ready to serve and the freezer will not go to idle. To return to normal operation push and hold for 5 seconds.

I. HIGH PRESSURE CUTOUT

The HIGH PRESSURE CUTOUT switch is a safety switch designed to protect the compressor from damage due to excessive head pressure. When tripped, the lever will be out, push in to reset.

J. DISPENSE RATE ADJUSTER

The DISPENSE RATE ADJUSTER limits the opening of the spigot.

To adjust product dispense rate, turn the adjusting knob clockwise for slower flow and counterclockwise for faster flow.

K. DOOR INTERLOCK SWITCH

When the door is securely fastened, the freezer will operate normally. When the door is removed, the drive and compressor will not run.

L. BLENDER POWER SWITCH (F131 Models Only)

The blender power switch is a two position toggle switch used to supply power to the blender. When the switch is in the OFF position, the agitator will not turn. When the switch is in the ON position, the agitator will be activated every time the blender activation switch is pressed.

M. BLENDER ACTIVATION SWITCH (F131 Models Only)

The blender activation switch is a two speed, momentary contact switch that will actuate the agitator to blend product when pressed in and held in either the HIGH or LOW speed position. The HIGH speed position is used to blend fruit into dairy mix when making smoothies. The LOW speed position is used during cleaning procedures.

3.3 SANITIZING

Sanitizing must be done after the freezer is clean and just before the hopper is filled with mix. **Sanitizing the night before is not effective.** However, you should always clean the freezer and parts after using it.

THE UNITED STATES DEPARTMENT OF AGRICULTURE AND THE FOOD AND DRUG ADMINISTRATION REQUIRE THAT ALL CLEANING AND SANITIZING SOLUTIONS USED WITH FOOD PROCESSING EQUIPMENT BE CERTIFIED FOR THIS USE.

When sanitizing the freezer, refer to local sanitary regulations for applicable codes and recommended sanitizing products and procedures. **The frequency of sanitizing must comply with local health regulations.** Mix sanitizer according to manufacturer's instructions to provide a 100 parts per million strength solution. Mix sanitizer in quantities of no less than 2 gallons (7.5 liters) of 120°F of water. Allow sanitizer to contact the surfaces to be sanitized for 5 minutes. Any sanitizer must be used only in accordance with the manufacturer's instructions.

CAUTION

Do not allow sanitizer to remain in contact with stainless steel freezer parts for prolonged periods. Prolonged contact of sanitizer with freezer may cause corrosion of stainless steel parts.

In general, sanitizing may be conducted as follows:

- A. Push the mix inlet regulator into hopper with air inlet (long) tube toward the front of the freezer. (Fig. 10).



Figure 10. Mix Inlet Regulator

- B. Prepare 2 gallons (7.5 liters) of sanitizing solution following manufacturer's instructions. Pour into hopper with mix inlet regulator in place (Fig. 11).



Figure 11. Sanitizing Procedure

- C. Place the OFF-ON toggle switch in the ON position while pressing the CLEAN switch. Check for leaks. (Fig. 12)



Figure 12. Clean Control

- D. Clean sides of hopper, mix inlet regulator and underside of hopper cover using a sanitized soft bristle brush dipped in the sanitizing solution (Fig. 13).



Figure 13. Sanitizing Hopper

- E. After five minutes, place a bucket under the spigot and open spigot to drain sanitizing solution. When solution has drained, press the CLEAN snap switch to stop the auger. Allow the freezer barrel to drain completely (Fig. 14).



Figure 14. Spigot Opened and Solution Draining

- F. Fill a tall cup with sanitizing solution. Completely immerse the blender's agitator shaft in the sanitizer solution. Do not wipe dry (Fig. 15).



Figure 15. Sanitizing Agitator Shaft

3.4 FREEZE DOWN AND OPERATION

This section covers the recommended operating procedures to be followed for the safe operation of the freezer.

- Sanitize just prior to use.
- Place the OFF-ON switch in the OFF position.
- With spigots open, pour approximately 1 gallon (3.8 liters) of mix into the hopper. Allow the mix to flush out about 8 ounces (0.23 liters) of sanitizing solution and liquid mix. Close the spigot.
- Fill hopper with approximately 3 gallons (11.4 liters) of prechilled (40°F or 4°C) mix.

NOTE

Do not overfill the hopper. Mix level must not be higher than 2 inches (5 cm) from the top of the air inlet tube on the mix inlet regulator.

- The freezer barrel will automatically fill until it is about 1/2 full. If freezer barrel does not fill, check for obstruction in the mix inlet regulator. If freezer barrel fills over 1/2 full, indicated by low overrun, check for leaks at the mix inlet regulator O-ring or check if the mix inlet regulator was installed correctly or that the freezer is level.

- Place the OFF-ON switch in the ON position, then press the PUSH TO FREEZE switch until the freezer starts.

NOTE

After the auger drive motor starts, there is a 3 second delay before the compressor starts.

- G. After about 6 to 10 minutes the freezer will shut off and the green lens will illuminate. The product will be ready to serve. Freeze down time may be longer for some frozen diet dessert mixes. High ambient temperatures may extend freeze down time.
- H. For normal dispensing, move the spigot handle fully open (Fig. 16).

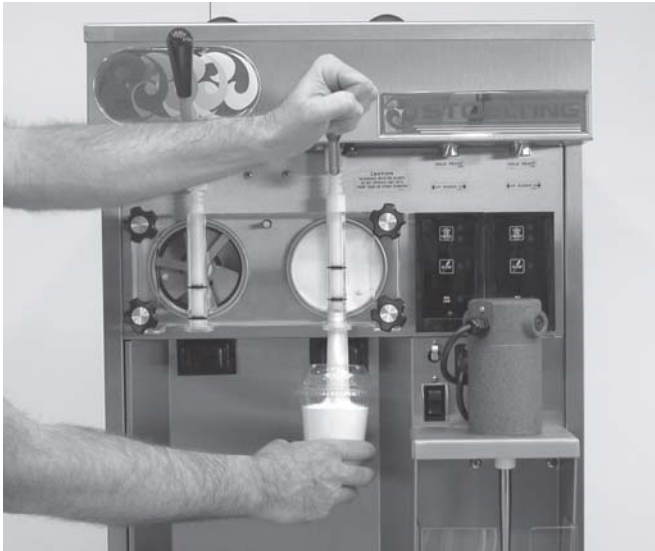

Figure 16. Dispensing Product

- I. The freezer is designed to dispense the product at a reasonable draw rate. If the freezer is overdrawn, the result is a soft product or a product that will not dispense at all. If this should occur, allow the freezer to run for approximately 30 seconds before dispensing additional product. After a while the operator will sense or feel when the freezer is beginning to fall behind, and will slow down on the rate of draw so as not to exceed the capacity.
- J. **Do not** operate the freezer when the MIX LOW light is on or with less than 1-3/4" (4.4 cm) of mix in the hopper. Refill the hopper immediately.

NOTE

The freezer has a standby mode sometimes referred to as a sleep or energy conservation mode. When the freezer is not used, after a preset time, it will enter the standby mode and remain there until someone draws a product or pushes the push-to-freeze switch. In the standby mode, the freezer will keep the product below 45°F. Standby modes are not to be used in place of cleaning and sanitizing. Frequency of cleaning and sanitizing is determined by Federal, State, and local regulatory agencies.

3.5 MIX INFORMATION

Mix can vary considerably from one manufacturer to another. Differences in the amount of butterfat content and quantity and quality of other ingredients have a direct bearing on the finished frozen product. A change in freezer performance that cannot be explained by a technical problem may be related to the mix.

When changing from one type of mix to another such as yogurt to Vitari, you may have to change the mix inlet regulator and/or control settings. Please call your distributor for further information.

Proper product serving temperature varies from one manufacturer's mix to another. Mixes should provide a satisfactory product in the 18° to 20°F (-7° to -6°C) range.

When checking the temperature, stir the thermometer in the frozen product to read the true temperature.

Mix **does not** improve with age. Old mix, or mix that has been stored at too high a temperature, can result in a finished product that is less than satisfactory in taste and appearance. To retard bacteria growth in dairy based mixes, the best storage temperature range is between 36° to 40°F (2.2° to 4.4°C).

Some products tend to foam more than others. If excess foam should occur, skim the foam off with a sanitized utensil and discard. Periodically, stir the mix in the hopper with a sanitized utensil.

3.6 REMOVING MIX FROM THE FREEZER

To remove the mix from the freezer, refer to the following steps:

- A. Remove the mix inlet regulator from the hopper by pulling straight up (Fig.17).



Figure 17. Removing Mix Inlet Regulator

- B. Place the OFF-ON rocker switch in the ON position and push the CLEAN switch to rotate the auger. Allow the mix to agitate in the freezer barrel until the mix has become a liquid, about 5 minutes.
- C. Drain the liquid mix by opening the spigot. A bucket or container should be placed under the spigot to catch the liquid mix (Fig. 18).



Figure 18. Draining Mix

3.7 CLEANING THE FREEZER

NOTE

The frequency of cleaning the freezer and freezer parts must comply with state and local health regulations.

After the mix has been removed from the freezer, the freezer must be cleaned. To clean the freezer, refer to the following steps:

- A. Close the spigot and fill the hopper with 2 gallons (7.5 liters) of cold tap water.
- B. Place the OFF-ON switch in the ON position while pushing the CLEAN switch to rotate the auger.
- C. Allow the water to agitate for approximately five minutes.

NOTE

If freezer is left in CLEAN for more than 30 minutes, it will go to error. Refer to Section 4 for instructions on clearing the error.

- D. Open the spigot to drain the water. Remember to place a bucket or container under the spigot to catch the water. When the water has drained, turn the OFF-ON switch to the OFF position. Allow the freezer barrel to drain completely.



CAUTION

Hazardous Moving Parts

Revolving blender agitator shaft can grab and cause injury. Remove watches and jewelry prior to operating blender. Keep hands and clothing away from revolving agitator. The Power switch must be placed in the OFF position for cleaning and when not in use.

- E. Fill a tall cup with clean 110°F (43°C) water. Press the low speed on the blender activation switch and allow agitator to run for 10 to 15 seconds (See Figure 19).



Figure 19. Cleaning Agitator Shaft

- F. Repeat steps A through E using a mild detergent solution.

3.8 DISASSEMBLY OF FREEZER PARTS



CAUTION

Hazardous Moving Parts

Revolving auger shaft can grab and cause injury. Place the POWER OFF-ON switch in the OFF position before disassembling for cleaning or servicing.

Inspection for worn or broken parts should be made at every disassembly of the freezer for cleaning or other purposes. All worn or broken parts should be replaced to ensure safety to both the operator and the customer and to maintain good freezer performance and a quality product. Two normal wear areas are the auger flights and front auger support bushing (Fig. 20). Frequency of cleaning must comply with the state and local health regulations.

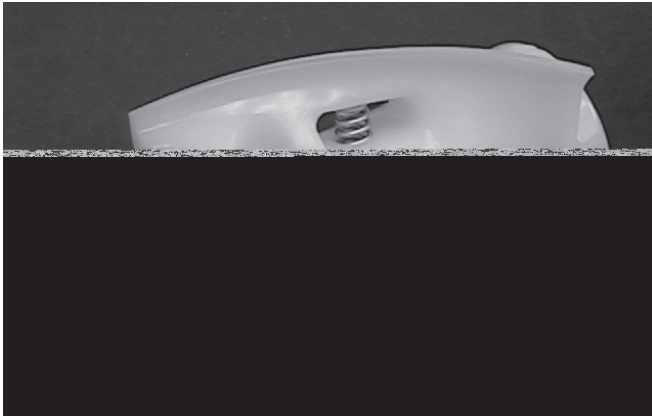

Figure 20. Auger Flight Wear and Front Auger Support Bushing Wear

D. Place the OFF-ON switch in the OFF position.

To disassemble the freezer, refer to the following steps:

- A. Remove the mix inlet regulator from the hopper by pulling straight up.
- B. Remove the front door by turning off the circular knobs and then pulling the front door off the studs (Fig. 21).



Figure 21. Removing Front Door

- C. Remove the rosette caps from the front door. Push the spigot body through the bottom of the front door and remove. (Fig. 22).

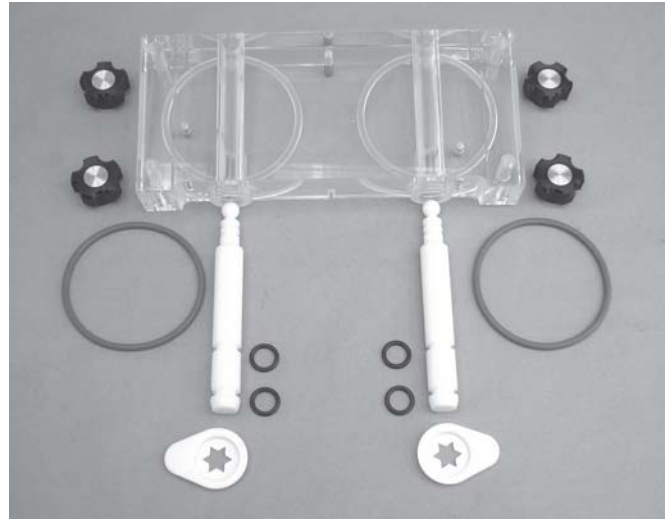

Figure 22. Front Door Disassembly

D. Remove the clear acrylic splash gaurd from the blender.

- E. Remove the blender's agitator from the agitator shaft. Grasp the agitator shaft in one hand, and turn the agitator in a clockwise direction with the other hand (Fig. 23).



Figure 23. Removing Agitator From Shaft

D. Remove the front auger supports and bushings (Fig. 24).



Figure 24. Removing Auger Supports

- G. Remove the auger assemblies from the freezer. Pull the augers out of the freezer barrel slowly. As the augers are being pulled out, carefully remove each of the plastic flights with springs.
- H. Keep the rear of the auger shafts tipped up once they are clear of the freezer barrels to avoid dropping rear seals.
- I. Wipe socket lubricant from the drive end (rear) of the auger with a cloth or paper towel.
- J. Remove the rear seals.
- K. Remove all O-rings from parts by first wiping off the lubricant using a clean paper towel. Then squeeze the O-ring upward with a dry cloth (Fig. 25). When a loop is formed, roll out of the O-ring groove.



Figure 25. Removing O-ring

CAUTION

Do not use any type of sharp object to remove O-rings. Using tools to remove O-rings may damage spigot and O-rings.

3.9 CLEANING THE FREEZER PARTS

Place all loose parts in a pan or container and take to the wash sink for cleaning. To clean freezer parts refer to the following steps:

- A. Place all parts in warm mild detergent water and clean with brushes provided. Rinse all parts with clean hot water.
- B. Wash the hopper and freezer barrel with warm detergent water and brushes provided.
- C. Clean the rear seal surfaces from the inside of the freezer barrel with warm detergent water.

NOTE

Clean the auger drive socket located inside the barrel at the rear seal area. Use clean cloth or paper towel for this purpose.

- D. Clean the drip trays and insert with a soap solution. Rinse with clean hot water.

3.10 SANITIZE FREEZER AND FREEZER PARTS

- A. Use a sanitizer mixed according to manufacturer's instructions to provide a 100 parts per million strength solution. Mix sanitizer in quantities of no less than 2 gallons (7.5 liters) of 120°F water. Allow the sanitizer to contact the surfaces to be sanitized for 5 minutes. Any sanitizer must be used only in accordance with the manufacturer's instructions.
- B. Place all parts in the sanitizing solution, then remove and let air dry.
- C. Using this sanitizing solution and the large barrel brush provided, sanitize the rear of the barrel and drive area by dipping the brush in the sanitizing solution and brushing the rear of the barrel.

3.11 ASSEMBLY OF FREEZER

To assemble the freezer parts, refer to the following steps:

NOTE

Petrol-Gel sanitary lubricant or equivalent must be used when lubrication of parts is specified.

NOTE

The United States Department of Agriculture and Food and Drug Administration require that lubricants used on food processing equipment be certified for this use. Use lubricants only in accordance with the manufacturer's instructions.

- A. Assemble all o-rings onto parts dry, **without lubrication**. Then apply a thin film of sanitary lubrication to exposed surfaces of the O-rings. Apply a thin film of sanitary lubricant to metal part of rear seal. Also apply a thin film of sanitary lubricant inside the hole of the front of the auger.
- B. Assemble the rear seals onto the augers with the large end to the rear. Be sure the O-ring is in place before installing the rear seal.
- C. Lubricate the inside of the auger drive sockets (rear) with a small amount of white socket lubricant. A small container of socket lubricant is shipped with the freezer.

- D. Screw the springs onto the studs in plastic flights.
Springs must be screwed into the flights completely to provide compression (Fig. 26).

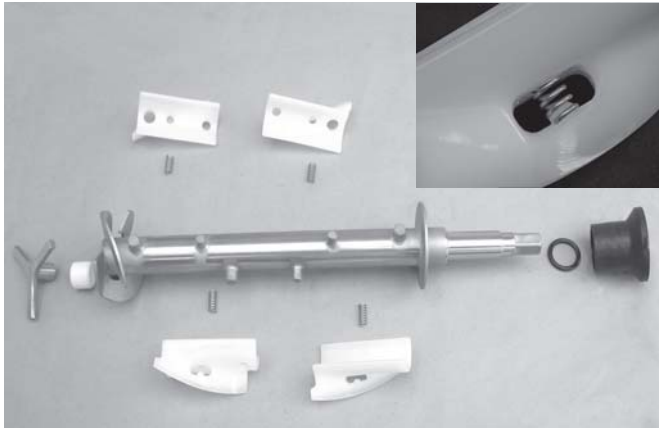

Figure 26. Exploded View of Auger

CAUTION
Do not place the mix inlet regulator into the hopper before installing the auger. Attempting to install the auger with mix inlet regulator in place will damage the mix inlet regulator.

- E. Install the two plastic flights onto rear of the auger and insert part way into freezer barrel.
- F. Install the third plastic flight, push the auger into the freezer barrel and rotate slowly until the auger engages the drive socket.
- G. Install the auger support and bearing into the front of the augers with one leg of the support at 9 o'clock.

NOTE

Apply a small amount of Petro-Gel to the surface of the cam on the spigot handle prior to assembly of handle to the spigot body.

- H. Install the spigot bodies with O-rings into the front door from the bottom (Fig.27). Push straight up until the spigots are in place. Install rosette caps.



Figure 27. Exploded View of Front Door

- I. Install the front door on the freezer.
- J. Install the circular knobs on the freezer studs.

CAUTION
Overtightening or uneven tensioning of circular knobs may cause damage to front door and cause leaking. Hand tighten circular knobs evenly.

Look for the proper seal between the freezer barrel, O-ring, and front door.

- K. Install the mix air regulator into the freezer with the air tube to the front of the freezer. (Fig. 28).

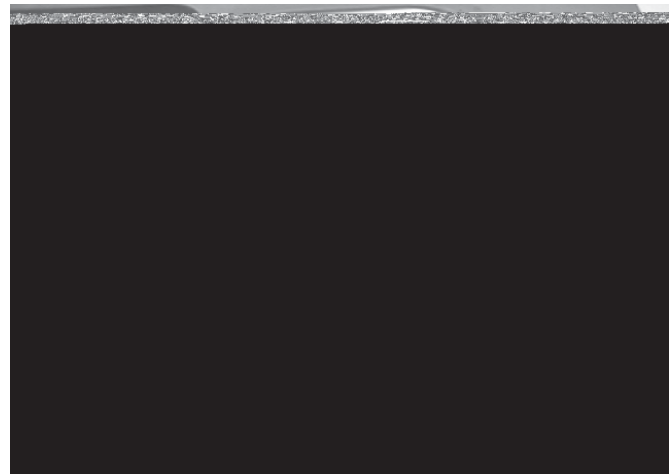

Figure 28. Install Mix Inlet Regulators

- L. Thread agitator onto blender agitator shaft. (Fig. 23).

NOTE

Refer to page 3-2, section 3.3, for sanitizing the assembled freezer before filling with mix.

3.12 ROUTINE CLEANING

To remove spilled or dried mix from the freezer exterior, simply wash in the direction of the finish with warm soapy water and wipe dry. **Do not** use highly abrasive materials as they will mar the finish.

3.13 PREVENTIVE MAINTENANCE

It is recommended that a maintenance schedule be followed to keep the freezer clean and operating properly.

A. Cleaning and Sanitizing Information

Soft serve freezers require special consideration when it comes to food safety and proper cleaning and sanitizing.

The following information has been compiled by Purdy Products Company, makers of Stera-Sheen Green Label Cleaner/Sanitizer and specifically covers issues for cleaning and sanitizing frozen dessert machines. This information is meant to *supplement* a comprehensive food safety program.

Soil Materials Associated with Frozen Dessert Machines

MILKFAT/BUTTERFAT – As components of ice-cream/frozen custard mix, these soils will accumulate on the interior surfaces of the machine and its parts. Fats are difficult to remove and help attribute to milkstone build-up.

MILKSTONE – Is a white/gray film that forms on equipment and utensils that come in contact with dairy products. These films will accumulate slowly on surfaces because of ineffective cleaning, use of hard water, or both. **Milkstone is usually a porous deposit, which will harbor microbial contaminants and eventually defy sanitizing efforts.**

Once milkstone has formed, it is very difficult to remove. Without using the correct product and procedure, it is nearly impossible to remove a thick layer of milkstone.
(NOTE: general-purpose cleaners DO NOT remove milkstone.) **This can lead to high bacteria counts and a food safety dilemma.**

IT IS BEST TO CONTROL MILKSTONE ON A DAILY BASIS BEFORE IT CAN BECOME A SIGNIFICANT FOOD SAFETY PROBLEM.

In addition to food safety, milkstone can cause premature wear to machine parts which can add to costs for replacement parts or possibly more expensive repairs if worn machine parts are not replaced once they have become excessively worn.

Important Differences Between Cleaning and Sanitizing

CLEANING vs. SANITIZING

It is important to distinguish between cleaning and sanitizing. Although these terms may sound synonymous, they are not. BOTH are required for adequate food safety and proper machine maintenance.

CLEANING

- Is the removal of soil materials from a surface.
- Is a prerequisite for effective sanitizing.

NOTE

An UNCLEAN surface will harbor bacteria that can defy sanitizing efforts.

Bacteria can develop and resist sanitizing efforts within a layer of soil material (milkstone). ***Thorough cleaning procedures that involve milkstone removal are critical for operators of frozen dessert machines.***

SANITIZING

- Kills bacteria.
- Can be effective on clean surfaces only.
- **DOES NOT** clean or remove milkstone.

NOTE

Using a SANITIZER on an unclean surface will not guarantee a clean and safe frozen dessert machine.

Proper Daily Maintenance: The Only Way to Assure Food Safety and Product Quality

Proper daily maintenance can involve a wide variety of products and procedures. Overall, the products and procedures fall into three separate categories. *(Please note that this is a brief overview intended for informational purposes only.)*

1. **CLEANING** – This involves draining mix from the freezer barrel and rinsing the machine with water. Next, a cleaner is run through the machine. Then, the machine is disassembled and removable parts are taken to the sink for cleaning.
2. **MILKSTONE REMOVAL** – Since almost all cleaners do not have the ability to remove milkstone, the use of a delimer becomes necessary. Although this procedure may not be needed on a daily basis, it will usually follow the cleaning procedure. It requires letting a delimer solution soak in the machine for an extended period of time. Individual parts are also soaked in a deliming solution for an extended period of time (more about delimers in *Additional Information*).

- SANITIZING** – After the machine has been cleaned and contains no milkstone, the machine is reassembled. Then a FDA approved sanitizing solution is run through the machine to kill bacteria. The machine is then ready for food preparation.

As a recommended cleaner and sanitizer for your frozen dessert machine, STERA-SHEEN has proven to be one of the best daily maintenance products for:

- CLEANING** – Thorough removal of all solids including butterfat and milk fat.
- MILKSTONE REMOVAL** – Complete removal of milkstone.
- SANITIZING** – FDA-approved no rinse sanitizer for food contact surfaces.

Additional Information

THE USE OF DELIMERS

A delimer is a strong acid that has the ability to dissolve milkstone. This type of chemical may become necessary once high levels of milkstone have developed. While these products are very effective for removing HIGH levels of milkstone, they are not ideal for two reasons:

- PRODUCT SAFETY** – Strong acids are dangerous chemicals and handling them requires safety
- MACHINE DAMAGE** – Strong acids will attack metal and rubber causing premature wear of parts. The use of a delimer needs to be closely monitored to avoid damage to machine surfaces and parts.

With proper daily use of STERA-SHEEN or it's equivalent, there is no need for the use of a *DELIMER*.

DO NOT USE BLEACH

- BLEACH HAS ABSOLUTELY **NO** CLEANING PROPERTIES.
- BLEACH IS CORROSIVE. It can and will damage components of the machine causing premature wear and metal corrosion.

GENERAL PURPOSE CLEANERS

General purpose cleaners **do not** have the ability to remove milkstone. Milkstone will become a problem *if not remedied* with additional products and procedures.

THE USE OF CHLORINE TEST STRIPS

“Test strips” are used to determine concentrations of active chlorine in sanitizing solutions. To use the strips, tear off a small portion and submerge it into the sanitizing solution. Then, compare the color change to the color key on the side of the test strip dispenser to determine the approximate chlorine concentration.

The ideal concentration of chlorine needs to be 100 ppm (as stated by the FDA).

NOTE

Follow the directions on the container for proper concentration.

There are two main factors that contribute to falling chlorine concentrations in a sanitizing solution.

- PRODUCT USE** – As the chlorine in the solution is being used, chlorine concentrations fall.
- TIME** – As time passes, small amounts of chlorine “evaporate” from the solution. (That is why you can smell it.)

Sanitizing solutions *should not* be allowed to fall below 100 ppm chlorine. New solutions should be mixed once old solutions become ineffective

B. DAILY

- The exterior should be kept clean at all times to preserve the lustre of the stainless steel. A mild alkaline cleaner is recommended. Use a soft cloth or sponge to apply the cleaner.

CAUTION
Do not use acidic cleansers, stron caustic compounds or abrasive materials to clean any part of the freezer exterior or plastic parts. Use of these types of cleaners will cause equipment damage.

C. WEEKLY

- Check O-rings and rear seal for excessive wear and replace if necessary.
- Remove the drip tray by gently lifting up to disengage from the support and pulling out. Clean behind the drip tray and front of the freezer with a soap solution.

D. QUARTERLY



WARNING

High voltage will shock, burn or cause death. Turn off and lock out main power disconnect before servicing. Do not operate machine with cabinet panels removed.

The air-cooled condenser is a copper tube and aluminum fin type. Condensing is totally dependent upon airflow. A plugged condenser filter, condenser, or restrictions in the louvered panel will restrict airflow. This will lower the capacity of the system and damage the compressor.

The condenser must be kept clean of dirt and grease. The freezer must have a minimum of 3" (7.5 cm) of ventilation on the right and left sides of the unit for free flow of air (Figure 29). Make sure the freezer is not pulling over 100° F (37° C) air from other equipment in the area.

The water-cooled condenser is a tube and shell type. The condenser needs a cool, clean supply of water to properly cool the freezer, inlet and discharge lines must be 3/8" I.D. minimum.

The condenser and condenser filter require periodic cleaning. To clean, refer to the following procedures.

1. Remove the Phillips head screw from the bottom of the right side panel, and then slide the panels down and out.
2. To remove the condenser filter, grasp the top and pull off. Visually inspect for dirt. If the filter is dirty, shake or brush excess dirt off the filter and wash in warm, soapy water. Once the filter is clean rinse thoroughly in warm, clear water and shake dry, taking care not to damage the filter in any way (Figure 29).
3. Visually inspect the condenser for dirt by shining a light through the coil from the back (inside) of the condenser.
4. If the condenser is dirty, place a wet towel over the front (outside) of the condenser.

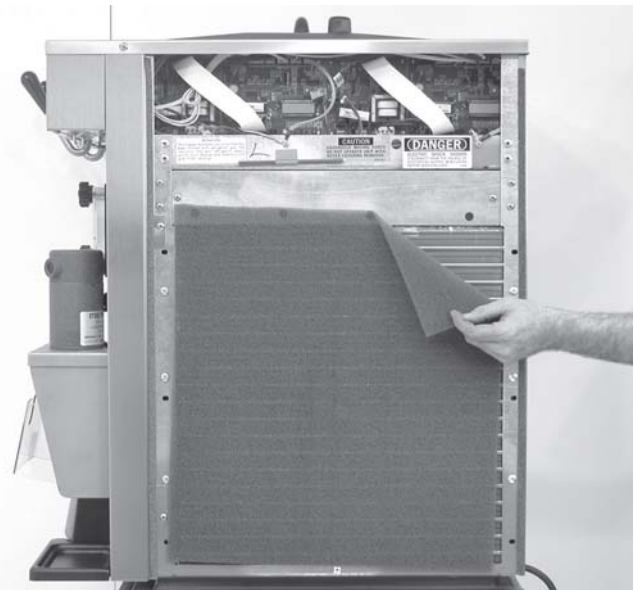

Figure 29. Condenser and Filter

5. Using a vacuum, carefully clean the condenser coil from the inside and outside of the freezer. A stiff bristled brush may help in releasing debris from between the condenser coils.



Figure 30. Cleaning Condenser

NOTE

If the condenser is not kept clean, loss of refrigeration efficiency will result; causing extended run time or soft product consistency.

Water-cooled condensers need an unrestricted supply of cold, clean water.

**SECTION 4
TROUBLESHOOTING CHARTS**

PROBLEM	POSSIBLE CAUSE	REMEDY
Freezer does not run.	<ol style="list-style-type: none"> 1. Power to freezer is off. 2. Fuse or circuit if blown or tripped. 3. Freeze-up (auger will not turn). 4. High pressure cut-out tripped. 5. Front door not in place. 	<ol style="list-style-type: none"> 1. Supply power to freezer. 2. Replace or reset. (If condition continues, see notes 1 or 2). 3. Turn OFF-ON switch to OFF for 15 minutes, then restart. 4. Reset high pressure cut-out. 5. Assemble front door in place.
Freezer does not run, PUSH TO FREEZE light flashes.	<ol style="list-style-type: none"> 1. Freezer has been left in the CLEAN mode for more than 30 minutes. 2. CLEAN switch has been activated 3 times within 10 seconds. 3. Low torque error. 	<ol style="list-style-type: none"> 1. Let light flash for 10 minutes, then place the OFF-ON switch to the OFF position to reset. 2. Leave OFF-ON switch in the ON position for 10 minutes, then place the OFF-ON switch to the OFF position to reset. 3. Place the OFF-ON switch to the OFF position to reset.
Freezer will not shut off.	<ol style="list-style-type: none"> 1. Not enough mix in hopper. 2. Drive belt failure. 3. Consistency temperature setting is too firm. 4. Consistency temperature control failure. 5. Refrigeration problem. 	<ol style="list-style-type: none"> 1. Fill hopper with mix. 2. Replace drive belt. 3. Readjust. (Call distributor for service.) 4. Replace. (Call distributor for service.) 5. Check system. (Call distributor for service.)
Product is too soft.	<ol style="list-style-type: none"> 1. Product is being dispensed when the PUSH TO FREEZE light is illuminated red. 2. No vent space for free flow of cooling air. 3. Air temperature entering condenser is above 100°F. 4. Condenser is dirty. 5. Consistency setting too soft. 6. Stabilizers in mix are broken down. 7. Auger is assembled wrong. 8. Refrigeration problem. 	<ol style="list-style-type: none"> 1. Press the PUSH TO FREEZE push button. Wait until the green light illuminates before dispensing. 2. A minimum of 3 inches of vent space required. 3. Change location or direct hot air away from freezer. 4. Clean. 5. Readjust. (Call distributor for service.) 6. Remove mix, clean, sanitize and freeze down with fresh mix. 7. Remove mix, clean, reassemble, sanitize and freeze down. 8. Check system. (Call distributor for service.)
Product is too firm.	<ol style="list-style-type: none"> 1. No mix in hopper. 2. Small portions are being dispensed in a short time. 3. Consistency temperature setting is too firm. 4. Consistency temperature control failure. 5. Line voltage fluctuating. 	<ol style="list-style-type: none"> 1. Fill hopper with mix. 2. Allow freezer to sit idle for 5 minutes before dispensing. 3. Readjust. (Call distributor for service.) 4. Replace. (Call distributor for service.) 5. Check. (Call distributor for service.)

PROBLEM	POSSIBLE CAUSE	REMEDY
Product does not dispense.	<ol style="list-style-type: none"> 1. No mix in hopper. 2. Mix inlet regulator tube is plugged. 3. Special mix inlet regulator needed for mix being used. 4. Capacity of freezer is being exceeded. 5. Drive motor overload tripped. 6. Drive belt failure. 7. Freeze-up. (Auger will not turn.) 	<ol style="list-style-type: none"> 1. Fill hopper with mix. 2. Unplug, using small sanitized brush. 3. Order special mix inlet regulator. 4. Slow up on the draw rate. 5. Wait 30 minutes for drive motor overload to reset. (If condition continues, call distributor for service.) 6. Replace drive belt. 7. Turn OFF-ON switch to OFF for 15 min., then restart.
Drive belt slipping or squealing.	<ol style="list-style-type: none"> 1. Worn drive belt. 2. Freeze-up (Auger will not turn). 	<ol style="list-style-type: none"> 1. Replace drive belt. 2. Turn OFF-ON switch to OFF for 15 min., then restart.
Low overrun.	<ol style="list-style-type: none"> 1. Auger is assembled wrong. 2. Mix inlet regulator missing. 3. Mix inlet regulator O-ring missing. 4. Mix inlet regulator air tube blocked. 5. Product breakdown. 	<ol style="list-style-type: none"> 1. Remove mix, clean, sanitize, and freeze down with fresh mix. 2. Replace mix inlet regulator. 3. Replace mix inlet regulator O-ring. 4. Clean with sanitized brush. 5. Fill freezer with fresh product.
Front door leaks	<ol style="list-style-type: none"> 1. Front door knobs are loose. 2. Spigot parts are not lubricated. 3. Chipped or worn spigot O-rings. 4. O-rings or spigot installed wrong. 5. Inner spigot hole in front door nicked or scratched. 	<ol style="list-style-type: none"> 1. Tighten knobs. 2. See paragraph 3.11 3. Replace O-rings. 4. Remove spigot and check O-ring. 5. Replace front door.
Hopper will not maintain mix temperature below 45°F (7°C)	<ol style="list-style-type: none"> 1. Consistency control on board needs to be adjusted. 2. Consistency control failure. 3. EPR valve needs adjustment. 4. Refrigeration problem. 	<ol style="list-style-type: none"> 1. (Call distributor for service.) 2. Replace. (Call distributor for service.) 3. Adjust EPR valve. (Call distributor for service.) 4. Check system. (Call distributor for service.)

ERROR CODE SYSTEM

<u>CODE</u>	<u>P.T.F. LIGHT FLASHES</u>	<u>MEANING</u>
01	Sequence of one	* Program board
02	Sequence of two	* Power board
03	Sequence of three	* Low torque error
04	Sequence of four	** Clean error
05	Sequence of five	* Barrel sensor
06	Sequence of six	* Hopper sensor
07	Sequence of seven	* Drive motor

*Refer to Page 19 for Troubleshooting.

**If the Clean switch is operated three times within 10 seconds, this will cause the Push-To-Freeze light to flash and the clean function will be disabled for 10 minutes. The power switch must remain on or the 10 minute timer will not time out. A flashing clean light is not an error.

NOTE

Flashing CLEAN light is not an error. It indicates the freezer is in the CLEAN mode. To exit, turn the OFF-ON switch to the OFF position.

SECTION 5 REPLACEMENT PARTS

5.1 HOW TO ORDER PARTS

To assure receipt of the proper replacement parts, supply your dealer or distributor with the following information:

- A. Model number of equipment.
- B. Serial number of model, stamped on nameplate.
- C. Part number, part name and quantity needed. Common part names and numbers are listed in this manual.

Part Number	Description	Part Number	Description
208135	Brush, Nylon: 16" x 4", Wooden Handle	324686	Danger Automatic Start
208380	Brush, Nylon: 14" x 1/4", Wire Handle	324105	Danger - Electrical Shock Hazard
208401	Brush, Nylon: 10" x 1", Wire Handle	324106	Caution - Electrical Wiring Materials
208467	Brush, Nylon: 5-1/4" x 3/8", Wire Handle	324141	Caution - Hazardous Rotating Blades
3177946-04	Model ID Plate	324584	Adequate Ventilation
324594	Heat Sensitive	324566	Wire According to
324107	Caution - Hazardous Moving Parts	324509	Decal, Cleaning

O-RING IDENTIFICATION SHEET MODEL FUTURA 144

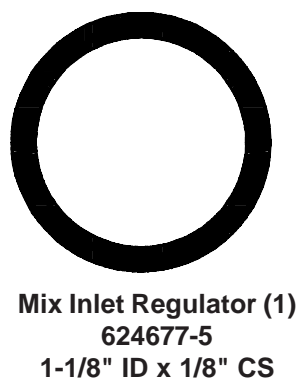
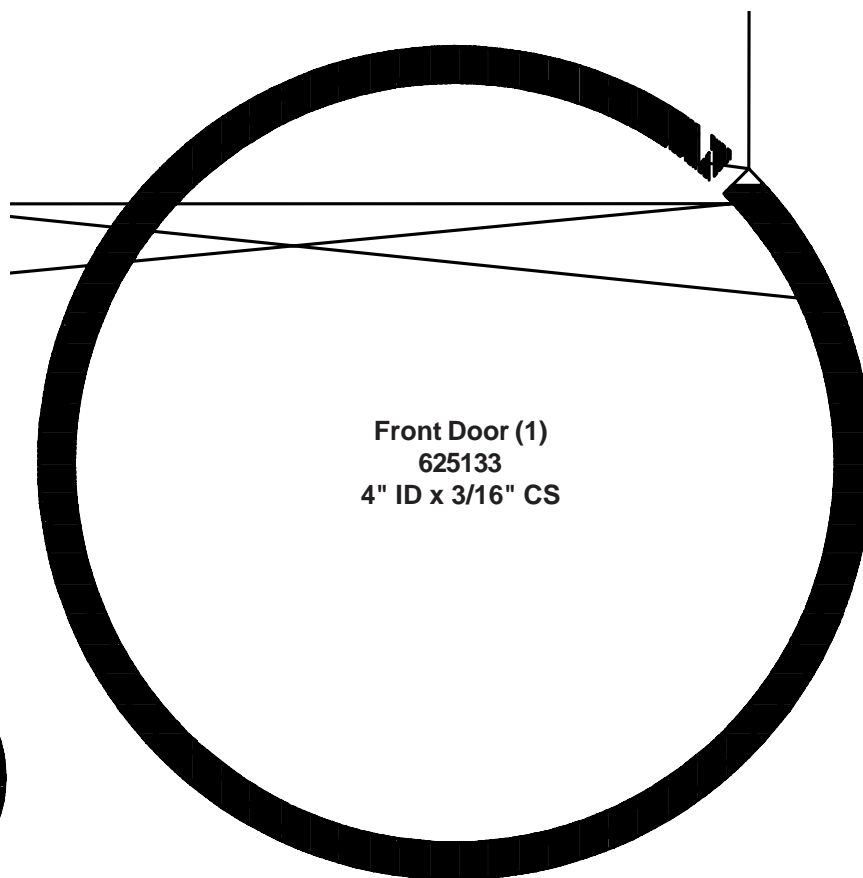
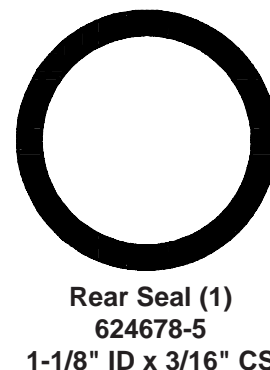

**O-rings are drawn to
Approximate Size**

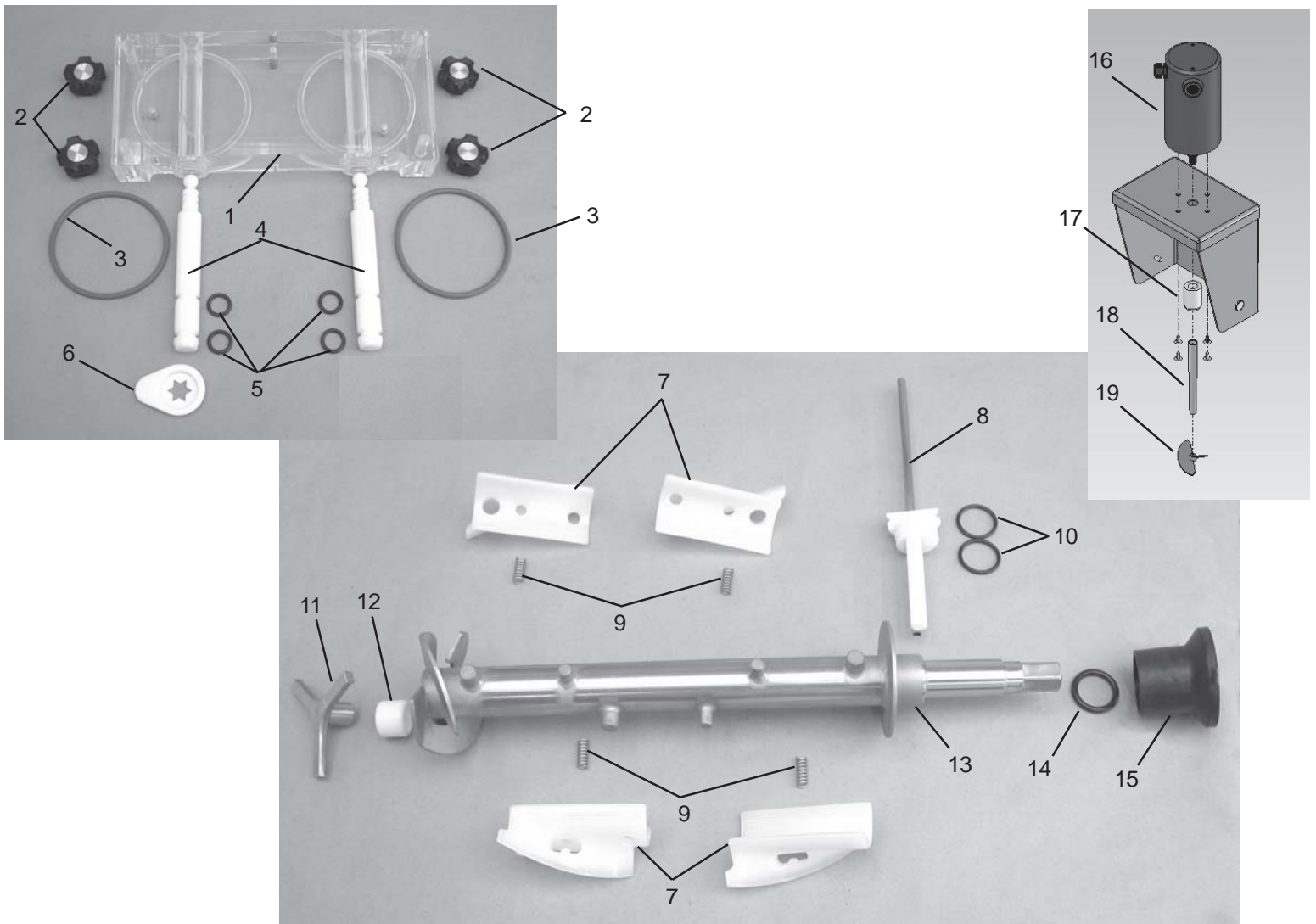

Figure 31. Spigot, Front Door and Auger Assembly

Item No.	Part No.	Description	Qty.
1	2183047	Front Door Only	1
	2177072	1.5" Spigot Extension	
	2177073	2.5" Spigot Extension	
	2177074	3" Spigot Extension	
2	482019	Circular Door Knob	4
3	625133	O-ring Front Door	2
4	3159696	Spigot	2
5	624598-5	O-ring Spigot (5 Pack)	4
6	232734	Rosette Cap	2
7	381804	Auger Flight	8
8	2149243-01	Mix Inlet Regulator	2
9	694255	Auger Spring	8
10	624677-5	O-ring Mix Inlet Regulator and Spigot Extension (5 Pack)	6
11	3170644	Front Auger Support	2
12	149003	Auger Bushing	2
13	4157968	Auger Shaft	2
14	624678	O-ring Auger Shaft Seal (5 Pack)	2
15	666786	Auger Shaft Seal	2
16	522839	Blender Motor	1
17	274031	Blender Agitator Collar	1
18	674147	Blender Agitator Shaft	1
19	521026	Blender Agitator	1
20	744299	Blender Drip Tray (Not Shown)	1
21	681514	Clear Swing Splash Shield (Not Shown)	1



WARRANTY SOFT SERVE / SHAKE FREEZERS

1. Scope:

Stoelting, LLC warrants to the first user (the “Buyer”) that the freezer cylinders, hoppers, compressors, drive motors, speed reducers, auger and auger flights of Stoelting soft serve / shake freezers will be free from defects in materials and workmanship under normal use and proper maintenance appearing within five (5) years, and that all other components of such equipment manufactured by Stoelting will be free from defects in material and workmanship under normal use and proper maintenance appearing within twelve (12) months after the date that such equipment is originally installed.

2. Disclaimer of Other Warranties:

THIS WARRANTY IS EXCLUSIVE; AND STOELTING HEREBY DISCLAIMS ANY IMPLIED WARRANTY OF MERCHANTABILITY OR FITNESS FOR PARTICULAR PURPOSE.

3. Remedies:

Stoelting’s sole obligations, and Buyer’s sole remedies, for any breach of this warranty shall be the repair or (at Stoelting’s option) replacement of the affected component at Stoelting’s plant in Kiel, Wisconsin, or (again, at Stoelting’s option) refund of the purchase price of the affected equipment, and, during the first twelve (12) months of the warranty period, deinstallation/reinstallation of the affected component from/into the equipment. Those obligations/remedies are subject to the conditions that Buyer (a) signs and returns to Stoelting, upon installation, the Checklist/Warranty Registration Card for the affected equipment, (b) gives Stoelting prompt written notice of any claimed breach of warranty within the applicable warranty period, and (c) delivers the affected equipment to Stoelting or its designated service location, in its original packaging/crating, also within that period. Buyer shall bear the cost and risk of shipping to and from Stoelting’s plant or designated service location.

4. Exclusions and Limitations:

This warranty does not extend to parts, sometimes called “wear parts”, which are generally expected to deteriorate and to require replacement as equipment is used, including as examples but not intended to be limited to o-rings, auger seals, auger support bushings and drive belts. All such parts are sold

AS IS.

Further, Stoelting shall not be responsible to provide any remedy under this warranty with respect to any component that fails by reason of negligence, abnormal use, misuse or abuse, use with parts or equipment not manufactured or supplied by Stoelting, or damage in transit.

THE REMEDIES SET FORTH IN THIS WARRANTY SHALL BE THE SOLE LIABILITY STOELTING AND THE EXCLUSIVE REMEDY OF BUYER WITH RESPECT TO EQUIPMENT SUPPLIED BY STOELTING; AND IN NO EVENT SHALL STOELTING BE LIABLE FOR ANY INCIDENTAL OR CONSEQUENTIAL DAMAGES, WHETHER FOR BREACH OF WARRANTY OR OTHER CONTRACT BREACH, NEGLIGENCE OR OTHER TORT, OR ON ANY STRICT LIABILITY THEORY.

Free Manuals Download Website

<http://myh66.com>

<http://usermanuals.us>

<http://www.somanuals.com>

<http://www.4manuals.cc>

<http://www.manual-lib.com>

<http://www.404manual.com>

<http://www.luxmanual.com>

<http://aubethermostatmanual.com>

Golf course search by state

<http://golfingnear.com>

Email search by domain

<http://emailbydomain.com>

Auto manuals search

<http://auto.somanuals.com>

TV manuals search

<http://tv.somanuals.com>