

User's and installer's Manual

Sine wave Inverter, Battery charger, Transfersystem

HP-COMPACT - HPC 2800-12
HP-COMPACT - HPC 4400-24
HP-COMPACT - HPC 6000-48
HP-COMPACT - HPC 8000-48

Remote control **RCC-01**

Remote - Power sharing **RPS-01**

Temperature sensor **CT-35**

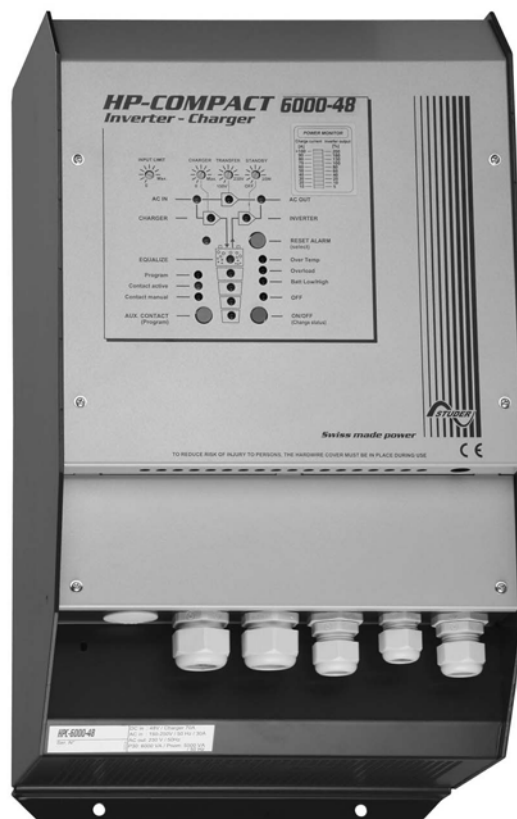

STUDER INNOTECH
Rue des Casernes 57
CH – 1950 Sion



TEL : ++41 (0)27 205 60 80
FAX : ++41 (0)27 205 60 88
E-MAIL : info@studer-innotec.com

English description	5
1 General Information	5
1.1 Operating instructions	5
1.2 Quality and Warranty	5
1.3 Warranty Disclaimer	5
1.4 Liability Disclaimer	6
1.5 Warning	6
1.6 Special precautions	6
2 Introduction	7
2.1 Principle schematic	7
2.2 Description of the main functions	8
2.3 Battery connecting	9
3 Mounting and installing	10
3.1 Installation place	10
3.2 Fixing	10
3.3 Connections	10
3.4 Connection Plan	10
3.5 Cabling	11
3.6 Pre-installation settings	11
4 Control	14
4.1 Display and control parameters	14
4.2 Light Emitting Diodes (LED)	15
4.3 Push buttons	16
4.4 Turning Knobs	16
4.5 The Inverter	16
4.6 The battery charger	18
4.7 The Transfer system	20
4.8 The Multifunctional Contact	21
4.9 The Remote Control RCC-01	22
4.10 The Temperature sensor CT-35	22
4.11 Remote control for „Power Sharing“ RPS-01	23
5 Programming	23
5.1 Standard setting	23
5.2 Reset value (default settings)	24
5.3 Battery voltages and absorption time	24
5.4 Auxiliary contact	25
5.5 Disabling some of the HP-COMPACT functions	27
6 Installation Maintenance	27
7 Declaration of CE Compliance	27
8 Technical Data	28

English description

1 General Information

1.1 Operating instructions

This manual is part of the delivery package of every HP-COMPACT inverter-charger. It serves as guidelines for safe and efficient operation of HP-COMPACT. The instructions are only valid for use with the following devices and options:

- HP-COMPACT : HPC 2800-12 – HPC 4400-24 – HPC 6000-48– HPC 8000-48
- Temperature sensor : CT-35
- Remote Control : RCC 01
- Remote power sharing : RPS-01

Every person who installs a HP-COMPACT and/or works with it must be fully familiar with the content of this manual and must follow exactly all the warning and safety instructions. Installation of or any work on the HP-COMPACT must be carried out by a skilled and trained personnel. Installation and application must comply with the respective local installations codes and safety regulations.

1.2 Quality and Warranty

During production and assembling, all HP-COMPACT appliances go through many controls and tests. Production, controls and tests are carried out in accordance with firm and established procedures. Every HP-COMPACT has its own serial number, which helps to refer back to its original data in the event of controls or repairs. That is why you should never remove the identification plate showing the serial number. The production assembly and tests on all HP-COMPACT appliances are totally carried out in our company in Sion, Switzerland. The warranty for these appliances is valid for uses and operating possibilities mentioned in this manual.

The warranty period for the HP-COMPACT is 2 years.

1.3 Warranty Disclaimer

We do not accept any liability for any damages occurring through use, manipulation, working situation and handling, which are not explicitly mentioned in these operating instructions.

Following cases are not covered by the warranty:

- High voltage at INPUT (i.e. 48V at the Battery INPUT of HP-COMPACT 2800-12)
- Reverse polarity on Battery connections (+/- reversed)
- Running liquid or oxidation through condensation in the appliance
- Defects caused by force, physical or mechanical means
- Changes not explicitly authorized by STUDER INNOTEC
- Not or only partly tightened screws and nuts after change of fuses or cables connecting
- Transport damage, i.e. through bad handling and /or packing
- Damage from atmospheric over voltage (lightning)

1.4 Liability Disclaimer

Respecting this manual, servicing and method of installation, functioning, application and maintenance of the appliance can not be controlled or supervised by STUDER INNOTEK. Hence we do not accept any liability and responsibility for damages, losses and costs which result through the use of this appliance or which result through incorrect installation, incorrect operation or wrong application and maintenance, or which by some other means maybe connected to each other.

The use of STUDER INNOTEK's inverters does exclusively involve the user's liability.

This device is not designed for applications involving health care and medical treatments where the patient life is concerned and where any mishap may be lethal.

Similarly, we do not accept any liability for any violation of the patents rights or violation of any third party's rights resulting from the use of this appliance

STUDER INNOTEK reserves the right to modify the technical data or these operating instructions without any prior notice.

1.5 Warning

This manual must be readily available for the user at any time. The user must be familiar with the precautions and safety aspects in the country of installation.

During operation of HP-COMPACT, high voltages are generated at the connections and inside of the appliance which could be lethal. Work on the appliance and on the installation should only be carried out by skilled and trained people.

The whole installation connected with the HP-COMPACT must comply with the rules and codes in force.

People without the written authorization from STUDER INNOTEK are strictly forbidden to carry out any change or repair on the appliances. For authorized changes only original parts are to be used.

The HP-COMPACT may only be used when it has been installed in accordance with these instructions and all parts have been correctly assembled and installed.

The HP-COMPACT may only be connected to lead-acid or lead-gel batteries.

Caution: Even when a HP-COMPACT has been disconnected from all connections, at the OUTPUT point there could still be deadly voltages present. To remove these voltages you must switch on the HP-COMPACT ON with the ON/OFF switch. After one minute the electronics are discharged and any work can now be safely carried out.

The HP-COMPACT is only suitable for internal use and under no circumstances should it be subjected to snow, rain, or any other wet conditions.

By installations in motorized vehicles the HP-COMPACT must be protected from water-spray and any other wet conditions.

Caution: In normal use lead-acid and lead-gel batteries give out explosive gases. Never smoke or allow a spark or flame in the vicinity of batteries. The batteries must always be stored or placed in a well ventilated room, they should be placed in such a way that there is no danger of short-circuit through carelessness. Never charge frozen batteries.

1.6 Special precautions

- While working on batteries there should always be a second person close to you or within your voice range, in case help is needed.

- Plenty of fresh water and soap must be ready at hand so that in case of acid coming in contact with skin, eyes and clothes, the areas in question can be thoroughly washed.
- If acid enters the eyes, you must thoroughly wash them with cold running water for at least 15 minutes. It is recommended that you immediately consult a medical doctor.
- Baking powder neutralizes battery acid electrolyte. Always keep some at hand.
- Special care must be taken when working with metal tools near or on the batteries. With tools such as screwdrivers, spanners etc. short-circuits can result. Sparks produced by the short circuit can cause an explosion.
- When working on batteries all personal metal items such as rings, necklaces and bracelets must be removed. Batteries are so powerful that short-circuit with these items can melt them and thus cause severe burns. Always follow the battery manufacturer instructions.
- Under certain conditions HP-COMPACT or a connected generator can start automatically. While working on an electrical installation you must ensure that these appliances are disconnected beforehand from the installation.

2 Introduction

The HP-COMPACT is a sine wave inverter with integrated battery charger with many additional functions, it has been developed to be used as stand-alone (no grid-feeding) AC provider, or as continuous / break-free current supply provider (UPS).

2.1 Principle schematic

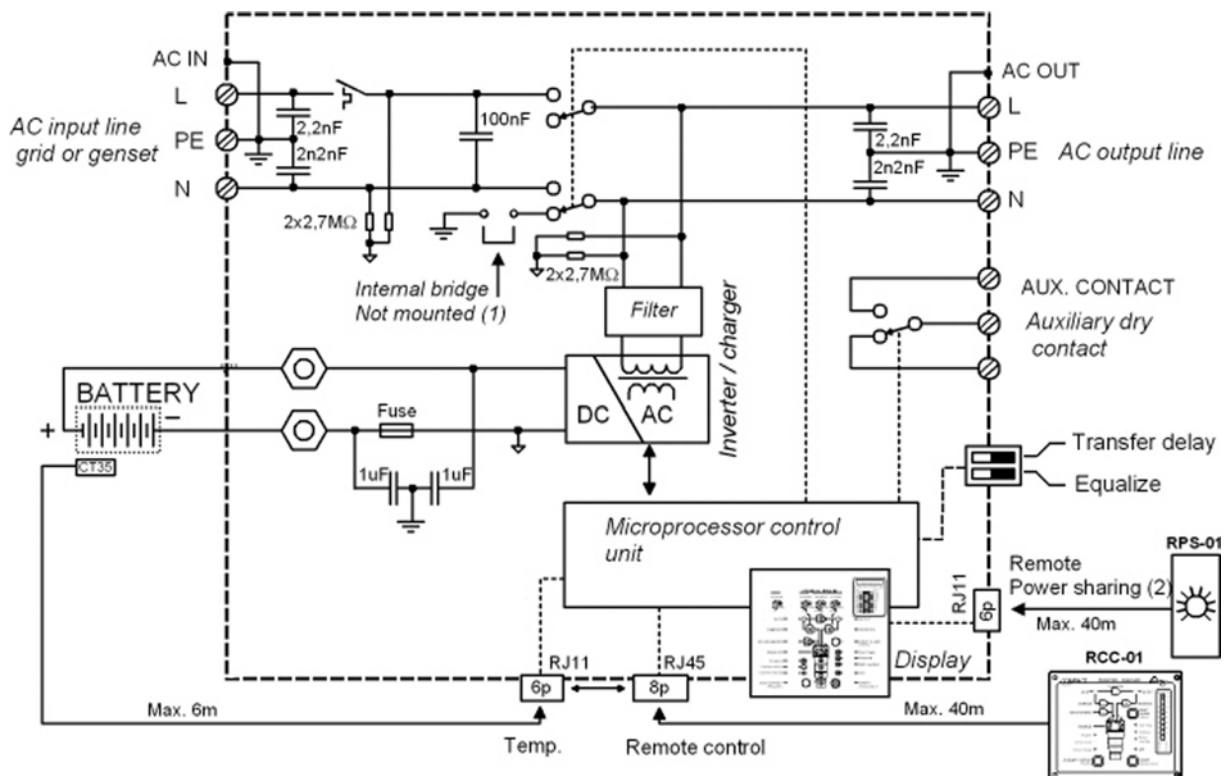

Notes:

(1) **The neutral of the appliance is not connected to the earth** whatever the function mode is. If requested and according to the local regulation, an automatic

connection between Neutral and earth in inverter mode only may be done by installing a bridge internally to the unit. Please contact your installer regarding this point.

(2) Remote control for remote adjustment of the input limit. (see chap. 4.6.3)

2.2 Description of the main functions

2.2.1 *The inverter*

The sine wave inverter HP-COMPACT generates a sinusoidal AC voltage with an exceptionally precise voltage and stabilized frequency. In order to start large electric motors, the user has the possibility to use a short surge power which is 3 times the nominal power of the HP-COMPACT.

The inverter is protected against overload and short circuit. A power stage with the latest MOS-FET power transistors, a toroidal transformer, and a fast regulating system makes a robust and reliable inverter with the highest efficiency. A 1-20 Watt adjustable charge detection system allows the smallest energy consumption and ensures a long life for the battery.

2.2.2 *The transfer system*

HP-COMPACT can be connected to an AC source. For example a stand-by emergency generator or the AC network. With the transfer system, on one side you have an alternating voltage at the output for the use of consumer appliances. On the other side the battery park is being charged. The distribution of energy between the consumer appliances and battery charger is automatic.

2.2.3 *The battery charger*

The built-in battery charger is so designed that it can charge the battery quickly and fully. A microprocessor controlled, Step charging process, ensures the optimal charging of the battery. The desired charging current can be set continuously from 0 to 70/90/100/110 A, as per the model. The setting is made accordingly to the battery capacity and power available.

The battery charger is designed for lead-acid and lead-gel batteries. Thanks to the floating charge system the batteries can remain continuously connected.

2.2.4 *Remote control*

As an option, a remote control RCC-01 can be connected to HP-COMPACT. All operating features and displays, save the adjustment levels (22/23/24/26), are available on the re-mote control. It is supplied with a 20m long cable. This cable can be up to 40m long. On the remote control, output power and charging current are also displayed.

2.2.5 *Remote control for Power Sharing*

This remote control RPS-01 can be connected to the HP-COMPACT in the gland for the temperature sensor. The maximum current available from the energy source can be adjusted by the turning button.

2.3 Battery connecting

Lead-acid batteries are normally available in blocks of 2V, 6V or 12V. In most cases, to generate the necessary operating voltage and the capacity of the batteries for the HP-COMPACT many batteries have to be connected together in parallel and or in series. Here are 3 examples of connection:

2.3.1 Connection in parallel

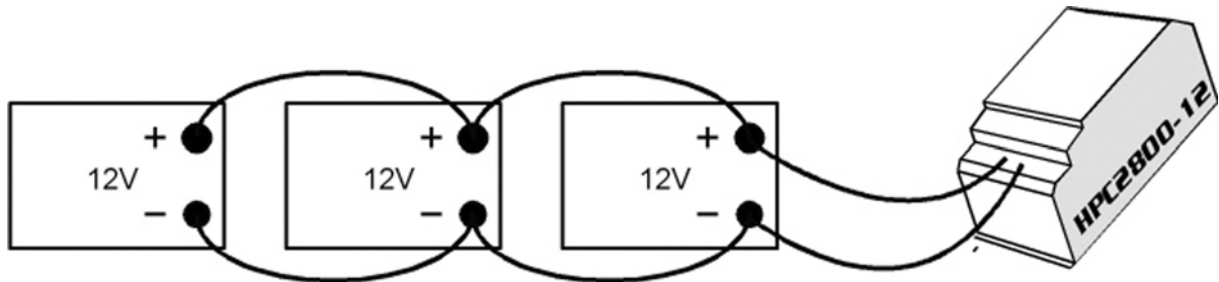

2.3.2 Serial connection

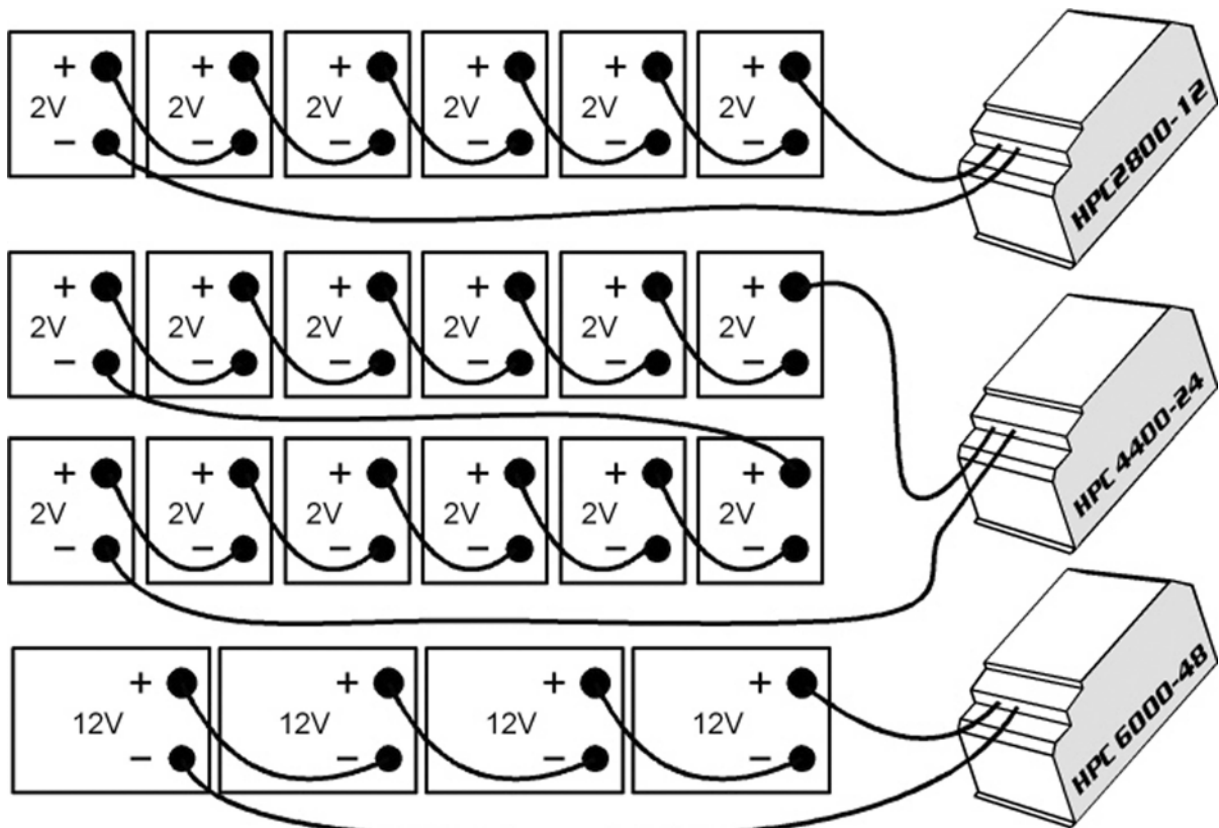

2.3.3 Serial and parallel connection

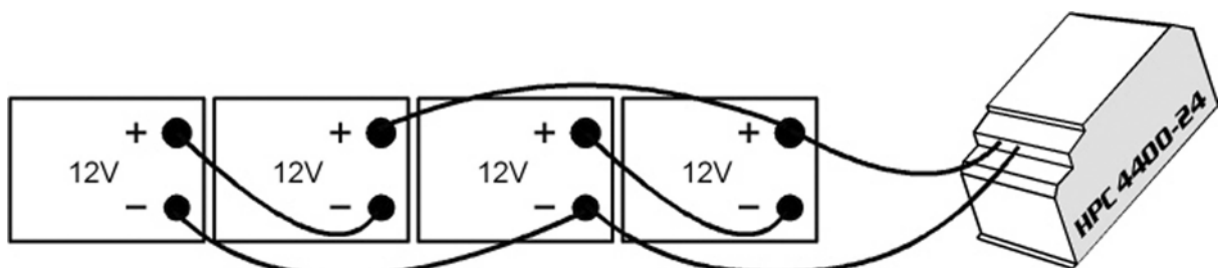

3 Mounting and installing

3.1 Installation place

The location of the HP-COMPACT must be driven by the following criteria:

- Protection from unauthorized handling
- Dry dust free room, no condensation
- Never install directly over the battery and never in a cabinet together with the batteries
- Keep ventilation holes free
- In mobile installations it is important to keep the vibrations down as low as possible

3.2 Fixing

Basically the HP-COMPACT can be installed in any desired location but only vertically. First of all the plate supplied along with the HP-COMPACT must be screwed firmly (due to the weight of the device) on the wall. Then the HP-COMPACT is hooked on the plate and screwed underneath.

Cautious: the fixing must be fully made otherwise the HP-COMPACT may fall and cause important damages.

In motor vehicles HP-COMPACT must be fixed on vibrations reducing elements. The HP-COMPACT must not be fixed on a combustible base, as the back of the casing can get hot and reach up to 60 degrees Celsius.

3.3 Connections

3.3.1 General instructions on connecting

- The cable connection on the terminals AC INPUT and AC OUTPUT must be carried out with a screwdriver Nr.3 and the connection of the AUX RELAY terminal with a screwdriver Nr.2.
- The conductor cross section on the terminals AC INPUT / AC OUTPUT / must comply with the local rules.
- All connecting cables and also the battery cables must be fixed with strain relief clamps.
- The fuses supplied with the HPC 4400-24, 6000-48 and 8000-48 have to be installed (see description in 3.4). The cable cross section for the HP 2800-12, 4400-24, 6000-48 and 8000-48 is resp. 95, 70, 50 and 70 mm² and their length must be as short as possible (max. 2m).
- The fuse supplied with the product (save for HPC 2800-12) does not protect the battery cables.
- **To protect the battery cables, a fuse corresponding to the conductor cross section must be fixed directly on to the battery.**
- All cables must be tightly screwed in place. For safety, a yearly control is recommended. In mobile installations controls must be carried out more often.
- Connecting must be done by qualified people. Material such as cable, connectors and distribution boxes, fuses etc. used in the installation must comply with the respective valid low-voltage installation rules and regulations in force.

3.3.2 Protection cover of the terminals connections

The protection cover must to be closed after any service on the appliance.

3.4 Connection Plan

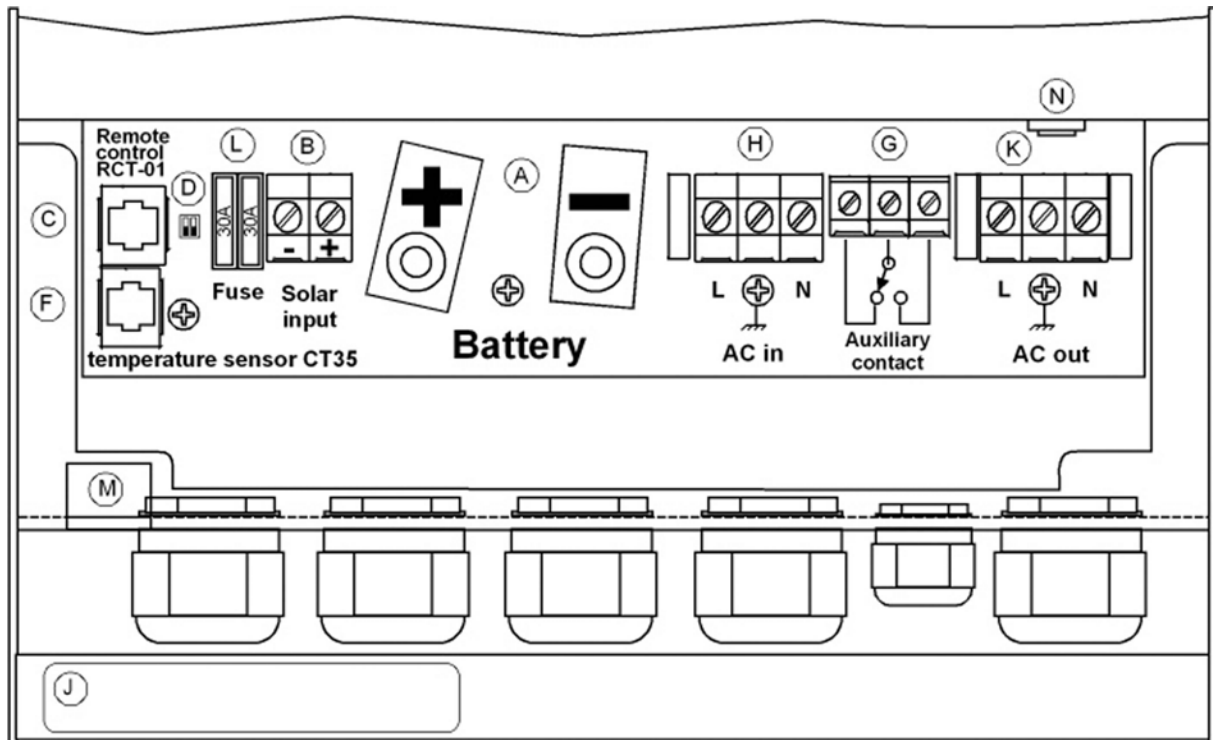

- | | | |
|---|----------------|---|
| A | Battery +/- | Connection terminal (M8) for battery cable (HPC 4400-24/6000-48/8000-48 with fuse) |
| B | Reserved | - |
| C | Remote contr. | Connection terminal for Remote Control RCC-01 |
| D | Transfer delay | Slide switch for Transfer Delay |
| E | Equalize | Slide switch for equalization of the Battery |
| F | Temp. | Connection terminal for Temperature sensor CT-35 and/or Remote Power Sharing RPS-01 |
| G | Aux. Contact | Connection terminal for Auxiliary Contact |
| H | AC Input | Connection terminal for AC-input |
| J | ID Plate | Identification plate with Technical data and Serial number |
| K | AC Output | Connection terminal for AC-output |
| L | Reserved | - |
| M | Hole | Pass through hole for RCC-01, CT-35 and RPS-01 |
| N | Protection | Thermal circuit breaker 30A (50A for HPC 8000-48) for the Transfer system |

3.5 Cabling

Connecting the HP-COMPACT is a very important step of the installation. You must take care that all connection work is carried out in a clean and correct way and that under no circumstance a cable is connected to a wrong terminal.

Connecting of the HP-COMPACT must be carried out in the following order. **In case of dismantling this order must be reversed.**

3.6 Pre-installation settings

Before you start with the cabling of the HP-COMPACT you must set the type of battery. In case sealed-gel batteries are used then you must set the small slide-switch „Equalize“ which is on the front with the connection terminals, in OFF position. In case of „normal“ lead-acid – batteries, these can handle a higher equalizing

charge, the same slide switch can be set in ON position. In case of doubt leave the setting in OFF position.

This will allow an equalizing cycle (higher end of charge voltage) during the next charge process. Since then equalizing will occur every 25 usual cycles.

3.6.1 Connection to battery

3.6.1.1 On the appliance side

Mount the supplied glands on the battery cable before the setting of the cable terminal. Set the cable terminal and mount the glands on the appliance. Repeat the process for the second battery cable.

Connect the red cable (+) on the “+ Battery” appliance connection point according to the plan below.

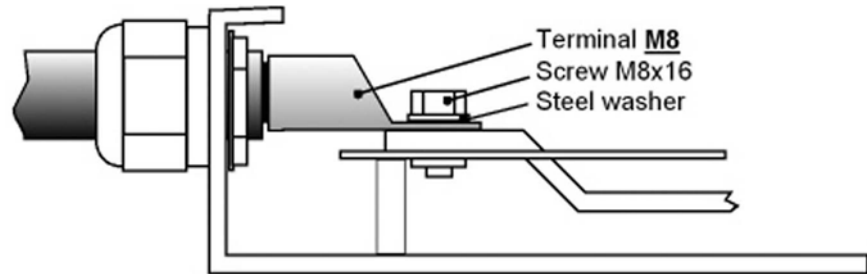

Connect the black cable (-) on the “- Battery” appliance connection point according to the plan above.

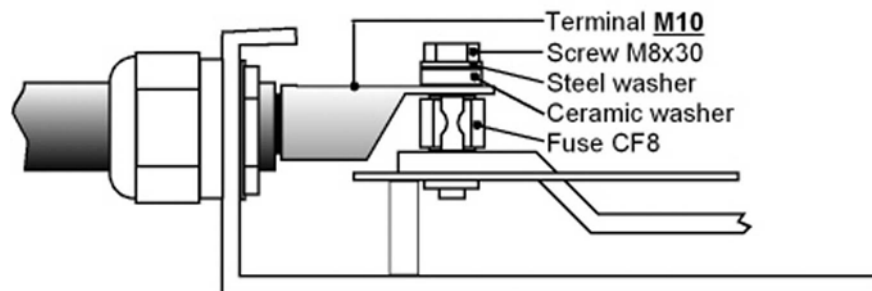

The supplied fuse (except with the HPC 2800-12) must be mounted according to the plan below.

3.6.1.2 On the battery side

Caution: before connecting the battery, check carefully the voltage and the battery polarity with a voltmeter. A polarity reverse will seriously damage the inverter (for example: connecting a HPC 2800-12 to a 48V-Battery).

Get the batteries ready for connection: suitable terminals, fuse on one of the connection points, cable in good shape with, if necessary, terminals rightly set. Mount the red cable on the positive (+) pole, and the black cable on the negative (-) pole of the battery.

While connecting the second cable, a spark due to the charge of the capacities at the input stage is normal. In the same time an acoustic signal tells that the control processor has started. All LED's of the synoptic light during a short time, then the synoptic shows that the appliance has stopped. The LED “OFF” (13) must be turned on.

After the battery connection, the battery state-of-charge LED shows a 100% capacity during 1 to 2 minutes, the necessary time for the processor to compute again the current state-of-charge of the battery.

If the LED “Battery Low/High” (12) is lighting, the battery voltage is too low. If it is blinking, the battery voltage is too high. Caution: a battery voltage too high or inappropriate can seriously damage the HP-COMPACT. For instance the connection of a 24 V battery with the HP-COMPACT 2800-12.

If by mistake the HP-COMPACT has been wrongly been connected (reverse battery polarity) it is likely that the internal protection fuse has melted and has to be replaced. In that case it is necessary to disconnect all connections to the HP-COMPACT,

including the battery. If after the fuse replacement and after re-connection of the battery with the right polarity, the HP-COMPACT remains out of order, it must be brought back to your merchant for service.

3.6.2 Connection to the 230Vac-consumer appliances (AC OUTPUT)

The 230V consumer appliances must be connected to the terminals AC OUTPUT with cables which cross section has to follow the local rules in force (usually 2.5mm²). Connections are marked as follows "N" Neutral, "PE" Earth (connected to the appliance box), "L" Live.

Caution: High voltages can be there. Make sure that the HP-COMPACT is turned off (LED 13 lighting) before the connection.

3.6.3 Connection to the 230Vac Input (AC INPUT)

The 230V-supply from network or from a generator must be connected to the input terminals AC INPUT with cables which cross section depends on the power source (usually 2.5mm²). Connections are marked as follows: "N" Neutral, "PE" Earth, "L" Live (connected to the appliance case).

3.6.4 Connection to Auxiliary Contact

This contact is a potential free change over contact the currents and voltages allowed for this contact are max. 16A/250Vac. The LED 5 "Contact active" shows the position of them: alight mind active and off mind non-active. The schematic view of the connections on the front, show the relay in the non-active mode.

3.6.5 Connection to Remote control

The Remote Control RCC-01 is connected in the terminal marked „Remote control“ with a 20m long cable and a RJ11/8 connector. The Remote Control can be plugged IN or plugged OUT during any operation situation. Push in the connector softly until you hear the „click“ showing that the connector is locked. The same applies to the plug in the Remote Control.

The length of the cable for Remote Control should not exceed 40m. We deliver it with 20m cable.

3.6.6 Connection to Temperature Sensor (Temp.)

The temperature sensor CT-35 is connected in the terminal marked „Temp“ with a 3m long cable and a RJ11/6 connector. The temperature sensor can be plugged IN or plugged OUT during any operating situation. Push in the connector softly until you hear the „click“ showing that the connector is locked. The temperature sensor must be glued to the wall of the battery or near it. **The Temperature Sensor cable must not be tied together with the battery cables or laid in a rope/bundle.**

3.6.7 Connection to the Remote Control for the „Power Sharing“ (RPS-01)

This remote control is connected with a 20m long cable and a RJ11/6 connector in the connection terminal „F“ (Temp. sensor). It can be connected and disconnected at any time. Push in the connector softly until you hear the „click“ showing that the connector is locked. In case the remote control is connected together with the Temp. sensor, a short cable with a Y-connector will be connected in the terminal „F“ (can be supply as an option).

4 Control

4.1 Display and control parameters

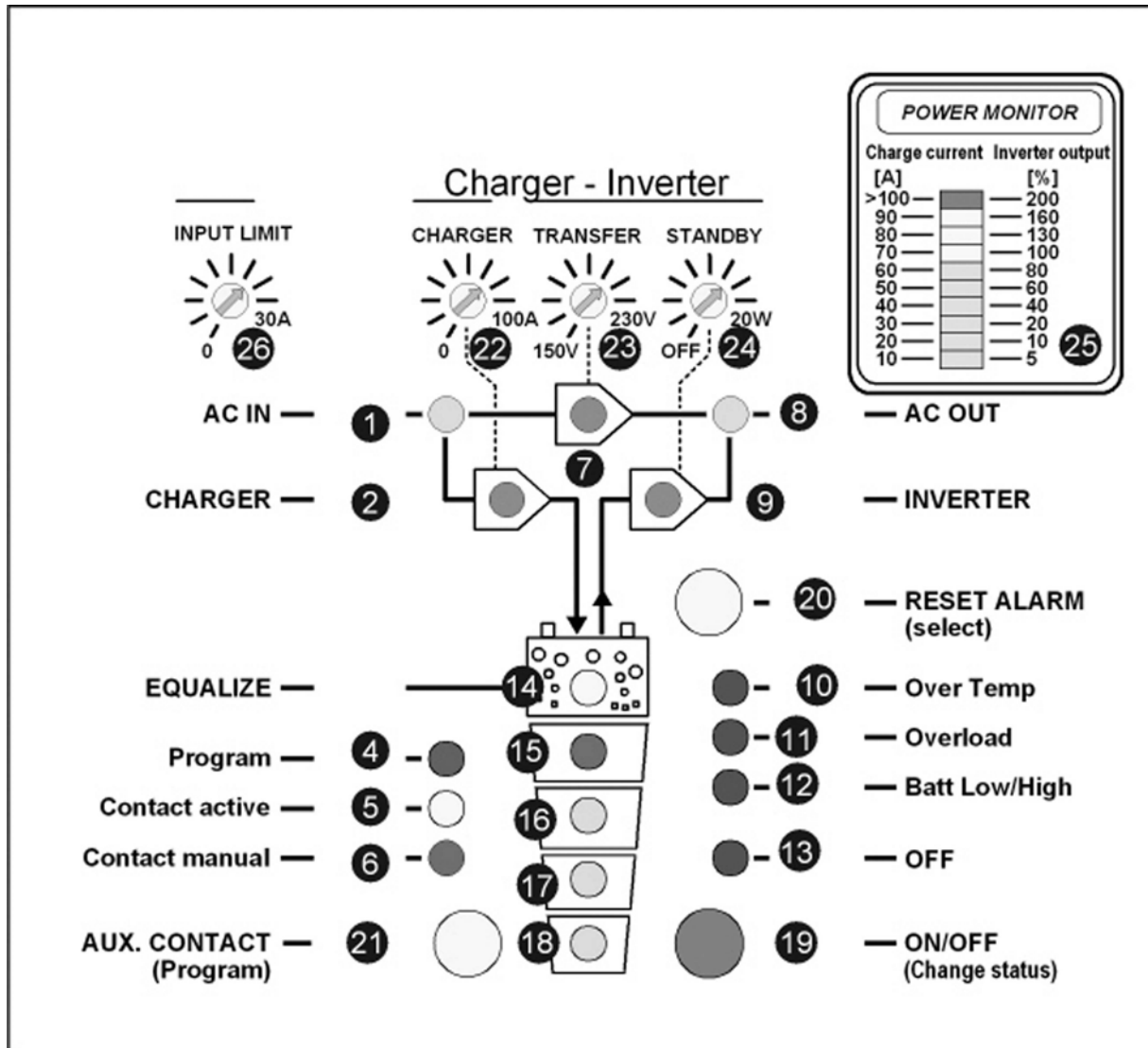

4.2 Light Emitting Diodes (LED)

LED	Marking	LED lit	LED blinks
1	AC IN	Voltage corresponding to self-adjusted values is at the AC IN input.	A voltage outside the self-adjusted values is at the AC IN input, or the HP-COMPACT is in synchronization phases
2	CHARGER	Battery charger is working	The battery charger is locked OFF (see chap. 4.6) or provisory out of order. In that last case it will restart within 10 seconds
3	Reserved		
4	Program	Program mode for Aux. Contact	
5	Contact active	Auxiliary Contact is activated	
6	Contact manual	Aux. Cont. manually activated	
7	TRANSFER	Transfer system is active. In-coming voltage is being sent directly to AC OUT outlet	Transfer (bypass) is disabled (see chap. 4.7)
8	AC OUT	There is a voltage at the AC OUT outlet	The Inverter is in Standby-Mode
9	INVERTER	Inverter is working	Forced Inverter Mode (see chap. 4.5)
10	Over Temp.	For the time being the HP-COMPACT is out of service because of overheating.	
11	Overload	The HP-COMPACT is out of service because of overload or short-circuit	
12	Batt. Low/High	Battery voltage is too low	Battery voltage is or was too high
13	OFF	HP-COMPACT is turned off. Turning it back on is only possible manually.	HP-COMPACT is for the time being turned off. Turning it back on will follow automatically !
14	EQUALIZE	Battery equalizing is set	
15-18		State of charge of the battery	LED 15 – Absorption time is running

25	POWER MONITOR	Display the value of the output power in % of Pnom (in Inverter Mode) and the charge current in Amps (in Charger Mode). In this mode the red LED indicates that power sharing is in use (>100A).
----	---------------	--

4.3 Push buttons

19	ON/OFF	Turning the HP-COMPACT on and off (Help Button for Programming)
20	RESET	Alarm Signal off (Help Button for Programming)
21	Aux. Contact	Control Aux. contact (Help Button for Programming)

4.4 Turning Knobs

22	CHARGER	Adjustment for max. Charging Current
23	TRANSFER	Adjustment for Transfer Voltage Threshold (TRANSFER – INVERTER)
24	STANDBY	Adjustment for „Standby“ system
26	INPUT LIMIT	Must be adjusted to the maximal available current of your AC INPUT supply

4.5 The Inverter

An Inverter is built in the HP-COMPACT, which generates a sinusoidal alternating voltage of a very high quality. With this Inverter any 230Vac alternating voltage appliance up to the nominal power of your HP-COMPACT can be operated. Thanks to the generous dimensioning of the HP-COMPACT, you can operate appliances requiring higher power than the nominal power of the HP-COMPACT for a short time. The HP-COMPACT provides up to 3-times the nominal power to start motors.

The Inverter mode is displayed through LED 9 (Inverter). If the Inverter Mode is disabled (see chap. 5.5) LED 9 will blink. If the LED 9 is lit, the Inverter is in operation and you have 230Vac at the output AC OUT. The actual power of the connected appliance is displayed on the power monitor 25 and on the Remote Control.

4.5.1 Charge detection system „Standby“

In order to avoid unnecessary discharge of the battery, the inverter switches OFF automatically if no appliance is connected and switches ON automatically again if appliance is connected. The LED 8 blinks if the inverter is in Standby-Mode. The switching-on/starting level can be adjusted with the turning knob 24 „STANDBY“. Adjusting the switching-on level is as follows: Switch off all consuming devices, turn the Turning Knob 24 to the right until the LED 8 is blinking, switch on the smallest consuming device (i.e. Mobile phone charger), turn the Turning Knob **slowly** to the left until LED 8 is lit.

If the Standby-Mode is not wanted, turn the Turning Knob 24 to the left, to the OFF position.

4.5.2 Overload

If the Inverter is too long or too heavily overloaded, it switches off. The LED 11 „Overload“ is lit and LED 13 „OFF“ blinks. After ca. 10 seconds the Inverter switches on automatically. If the Inverter is overloaded four times one after another in a short

time, then it no longer switches on automatically. The LED 13 remains lit. Press the push button 19 „ON/OFF“ in order to switch on the Inverter.

4.5.3 Overheating (Over Temp.)

If the Inverter has been overloaded for a long time or it has been working in too high surrounding temperatures, it will switch off. The LED 10 „Over Temp.“ is lit and the LED 13 „OFF“ blinks. After cooling down, the inverter switches back on automatically. One minute before the inverter switches off for too high temperature it gives out an acoustic alarm signal. If the Auxiliary Contact has been programmed to detect the high temperature then it synchronizes the relay with the alarm signal. In this way, for example, an emergency back- up system can be started without any break in the energy supply.

4.5.4 Battery Condition

Deep discharge of the lead-acid batteries leads to high losses in capacity and early aging. That is why the battery condition is continuously controlled and supervised. With low volt-age the inverter switches off. The LED 12 „L/H Batt.“ is lit and the LED 13 „OFF“ blinks. When the battery voltage gets up to 12.1V / 24.2V / 48.4V, the Inverter switches on automatically. One minute before the Inverter switches off due to low voltage it gives out an acoustic alarm signal. If the Auxiliary Contact has been programmed to detect the low voltage then it synchronizes the Aux. Contact with the alarm signal. In this way, for example, an emergency back up system can be started without any break in the energy supply.

The low voltage is set to 11.6V / 23.2V / 46.4V. These settings are standard for most batteries. These voltage levels are maintained by the built-in Battery-Management-System of the HP-COMPACT by matching the load and the battery condition.

This setting is comparable with the levels of 10.8V/ 21.6V / 43.2 which are given for most batteries at nominal load.

All voltage levels can be programmed. See the instructions under the section on Programming. Check with your battery supplier which voltage values should be set.

4.6 The battery charger

4.6.1 Cycle of charge

The full automatic HP-COMPACT Battery Charger is adjusted at the factory so that most lead-acid and lead-gel batteries can be charged to the maximum. As soon as the minimum alternating voltage for the AC IN set on the Turning Knob 23 is available at the input (LED 1 AC IN is lit), the Battery Charger is switched on automatically (LED 2 CHARGER is lit). The battery is fully automatically charged matching to the charge level, the adjusted volt-age levels and the charge current. Thanks to the built-in Float Charge System, the batteries can be left connected for unlimited time with the Battery Charger switched on.

During the charging phase the appliances at the outlet AC OUT are continually supplied with power (LED 8 AC OUT is lit).

The charger functions are shown in the following diagram:

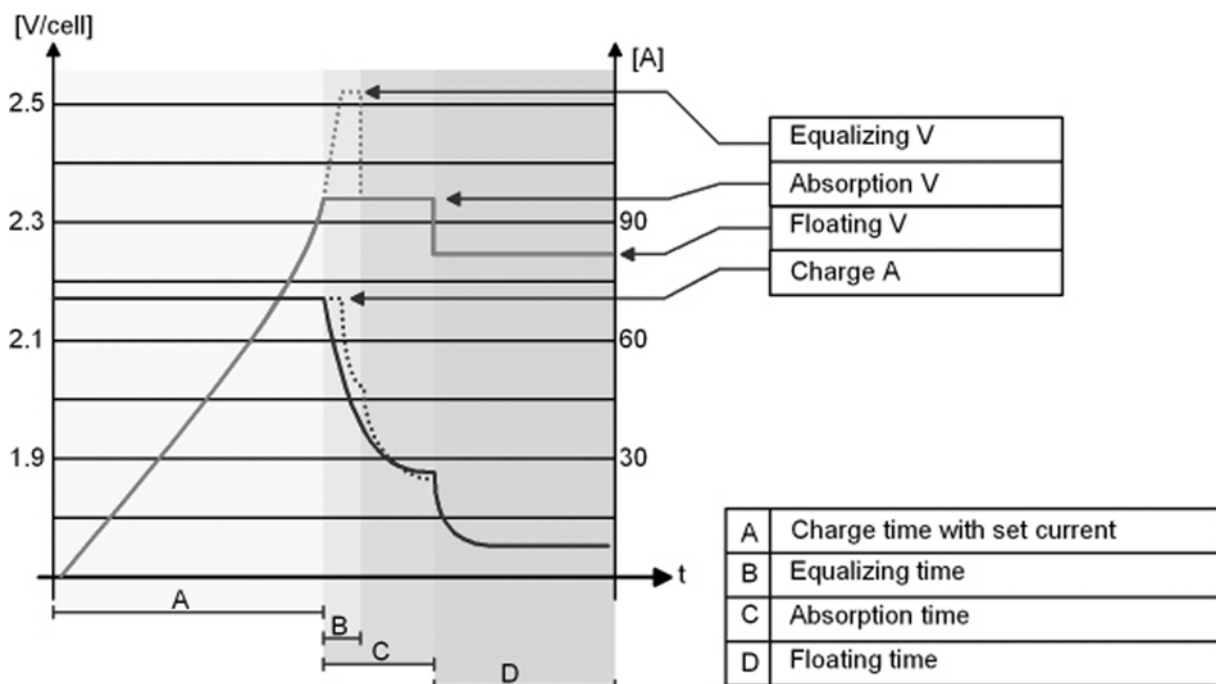

4.6.2 Default values for battery voltage thresholds

Low voltage			Float charge			Absorption			Equalization			Absorption time	Equalization time
12V	24V	48V	12V	24V	48V	12V	24V	48V	12V	24V	48V	12/24/48V	12/24/48V
11.6	23.2	46.4	13.5	27.0	54.0	14.4	28.8	57.6	15.6	31.2	62.4	2h	20'

These values can be modified by mean of the optional remote control

4.6.3 Equalization charging

Before you program the HP-COMPACT for Equalization-charge you must check with your supplier that the batteries are suitable for this process.

Equalization is recommended for the lead-acid batteries in order to mix well the electrolyte fluid and to clean the lead plates.

If the HP-COMPACT is operating with a lead-acid battery, which is suitable for equalization, the slide switch „Equalize“ which is on the cable connection side, must be placed in the ON position. In this setting, every 25 charge cycles an equalization is

carried out for 20 minutes (factory setting). During such a charge cycle the LED 14 is lit and during equalizing it is blinking. Charge cycle with equalization can be started independently from the actual program. For this purpose the slide switch must be slid from "OFF" to the "ON" position. The LED 14 will light up. If the periodic equalization is not required, slide switch must be slid back to the „OFF“ position after the completion of the manual cycle.

The equalizing voltage can be changed. How to proceed is explained in chap. 5.3.

Batteries not designed for equalize should never be charged this way.

CAUTION: During the equalization process, the batteries produce a lot more gas. DANGER OF AN EXPLOSION !! The battery room must be well ventilated. Equalization mode should never be used when using Gel-Batteries.

4.6.4 Input current repartition (Power sharing)

To manage the power available on the AC INPUT (depends on the supply use) the HP-COMPACT is equipped with a system usually called "Power sharing" or INPUT power distribution. With this function it is possible to limit the AC INPUT current assigned to the charger. The more current it uses on the OUTPUT the less it gives to the charger. Priority to the OUTPUT. When the power sharing is used the LED 200% (red) is lit to point out that the charge is limited.

Caution: if the power use on the OUTPUT is higher than the value of the INPUT LIMIT (26) the HP-COMPACT cannot limit the current, then the generator means to stop or the circuit breaker means to break before.

4.6.5 Set the INPUT LIMIT (26)

The current available for the HP-COMPACT depends on the supply used from a motor generator, the network of a camping or of a shore connection. The value of the turning knobs INPUT LIMIT (26) must be adjusted lower or equal to the current available from the source.

For example if you have a generator of 2kW you must adjust the turning knobs 26 to a max. 8.5A. To calculate this, one divides the nominal power (2000W) by the voltage (230V). If you have a circuit breaker (i.e. 6A) before the HP-COMPACT, then you set this value on the turning knobs (26) (i.e. 6A).

This adjustment can be done remotely with the optional RPS-01 (see section 3.6.7). In that case the smallest values will be taken into account.

Generator power	Current (230V)
500W	2A
900W	4A
1500W	6.5A
2000W	8.5A
3000W	13A
5000W	21A

4.6.6 Charging current

The maximum charging current for the battery can be adjusted with the Turning Knob 22 (CHARGER). The charging current of the battery should be set to approximately 10 – 20% of the battery capacity (at C10). This means that the charging current for a battery with 300Ah should be set between 30 – 60A.

The charging current is displayed on POWER MONITOR (25) of the front panel or on the Remote Control.

4.6.7 Battery Condition

Built-in microprocessor with a specially developed algorithm calculates the actual state of charge of the battery and displays it on LED 15 – 18. The LED 14 is lit when the system is carrying out a charge cycle with equalization.

Notice: the exact measure of the battery state of charge with electrical parameters is al-most impossible. The display of the state of charge is always more or less precise.

The measure system built in the HP-COMPACT takes into account the battery voltage, the discharge and charge current as well as the undulation of the voltage. If the battery and the HP-COMPACT are used according to their technical data, the battery state of charge is displayed accurately. In the following cases of use the display can diverge:

- Battery charge or discharge with too high currents
- Battery cable cross section too small
- Battery connections badly tightened or corroded
- Charge of the battery with external battery charger
- Discharge of the battery with users not connected to the HP-COMPACT
- Work with defective or sulphated batteries

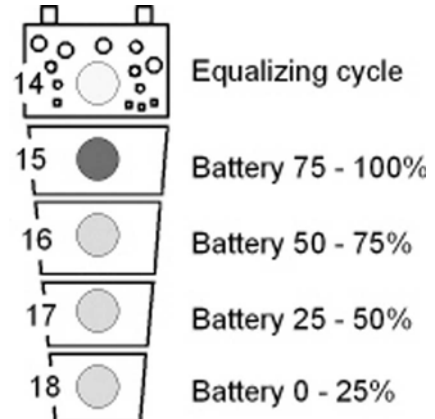

This means that the display can, within few minutes during the charge, commute from 25% to 75% or during the discharge, to the opposite direction.

As many of the working cases mentioned above often occur, the measure system of the HP-COMPACT takes into account, during the charge, only the peaks of the voltage undulation. As a consequence, the battery voltage at the start of the absorption stage, measured by a voltmeter will appear deeper. By decrease of the charge current the voltage will reach the exact values.

For safety reasons, you must get the recommended charge voltage and charge currents from your battery supplier. The voltage levels and charge characteristics can be changed through Programming. The instruction for programming of battery charger is in the section „Programming“ (Chap. 5.3). The correct charging is mandatory for a safe function and a long-life of the battery.

The battery charger are described by the graphic in chap. 4.6.1.

4.7 The Transfer system

When an AC voltage is at the input AC IN of the HP-COMPACT, the LED 1 AC IN is lit. When this voltage matches the lowest adjusted value set by the Turning Knob 23 TRANSFER, and the frequency is between 44Hz and 65Hz, this voltage is switched directly to the battery charger and to the output AC OUT. The LED 7 TRANSFER is lit. The inverter is switched off and the battery charger switched on. This process is automatic, unless the charger mode or the transfer mode is disabled (see Chap. 5.5).

The maximum current of the Transfer switch is 30A (50A for HPC-8000-48). That means through this system, appliances up to a maximum of 6900 Watt at 230V (11500W for HPC 8000-48) can be operated. When the Battery Charger is working, part of this power is used for charging according to the power sharing system.

The Transfer system is protected against overload with a circuit breaker on the AC Input side of the HP-COMPACT. If the system has been overloaded, the button/pin of the fuse will pop out. To put the automatic safety system back in to operating you must push this pin back.

Note: in the Inverter operation, The HP-COMPACT generates a true sinusoidal and quartz stabilized output voltage. However if the HP-COMPACT is supplied from a grid or a generator and the transfer contact is active, then you have at the output AC OUT the same voltage as that at the input. This voltage can not be modified by the HP-COMPACT !

4.7.1 Set the transfer voltage threshold

The voltage threshold of the transfer can be adjusted between 150 to 230V with the turning knobs (23). From factory this value is 200V. Most appliances can work on this voltage. When the Input voltages reach the selected value on turning knob, the inverter switches off and the AC INPUT goes directly on the AC OUTPUT. When the voltage INPUT is less of 20V the value set, the transfer is stopped and the OUTPUT switches back on the inverter.

Note : Don't use the turning knobs "TRANSFER" (23) to adjust the AC OUTPUT voltage ! This is only it's only a voltage threshold level to enable or disable the transfer.

4.7.2 FAST (UPS)- MODE for the Transfer Switch

The quick and break free Transfer mode is programmed with a slide switch „Transfer De-lay“ OFF, which is on the front side (cable connections side).

The aim of the HP-COMPACT is to supply the appliance with a break-free alternating volt-age. When the incoming voltage AC IN no longer matches values which have been set with the Turning Knob 23, the inverter switches on at once. The transfer is carried out in 0.02 seconds. This quick transfer ensures a break-free function for most appliances. If you have an alternating voltage back at the input AC IN, transfer system starts up again with-out any break, and the inverter is stopped.

4.7.3 Delayed mode of the Transfer System

The delayed mode of the transfer system „Transfer Delay ON“ is programmed with the slide switch on front with the cable connections. The HP-COMPACT provides a break-free alternating voltage for the appliance. A quick transfer switch is not always sensitive nor is it always desired. For example, when the appliances are operated by a small back-up generator. An overload of a short period on such a generator, i.e. start of a vacuum cleaner etc., has the effect of decreasing the voltage for a short time. As in such cases the transfer to the Inverter is not desired, the transfer system can be programmed with a delay. When the slide switch (Transfer delay) is in the „On“ position, the transfer to the inverter takes place with a delay of 5 seconds. If the voltage falls below 100Vac, the transfer takes place without delay ! The transfer switching to the Inverter takes place without any break.

4.8 The Multifunctional Contact

In the HP-COMPACT there is a built-in programmable power relay. The potential-free change-over contact (NO – NC) of this power relay is connected to the screw terminal AUX CONTACT.

**Maximum Contact load: 230Vac / 12Vdc / 24Vdc / 16A !
> 36Vdc / 3A !**

With the Push Button 21 „AUXILIARY CONTACT“ the contact can be manually switched on or off independently from programming and from the operating situation. The LED 5 “Contact active” shows the status of the contact. The drawing up the screw terminal “AUX CONTACT” is the inactive position mode, LED 5 “Contact active” off.

The switching on and off of this contact can be freely programmed for every operating situation of the HP-COMPACT witch situation is indicated with a LED. There is no limitation to its application and it is left to your wishes as to where and how you would like to use it. The example and the setting of this contact are explained in chapter 5.4.

In factory we program this for a dysfunction alarm. The contact is active when one of these situations is detected:

- Over temperature (LED 10 lit)
- Overload (LED 11 lit)
- Over or less voltage of batteries (LED 12 lit or blinking)
- HP-COMPACT is turned off manually or with a fault (LED 13 lit)

In case this function is not wished, it must be modified by programming according to procedure in chap. 5.4.

4.9 The Remote Control RCC-01

As an option, a Remote Control can be connected to the HP-COMPACT. All operating controls and displays except from level adjustment are available on the Remote Control. The Remote Control is supplied with a 20m long cable. It can as long as 40m. The Remote Control is suitable for surface mounting on the wall or on to a switch board. It is fixed with 4 screws. The HP-COMPACT can also be programmed with the Remote Control. The Programming is described in the section „Programming“.

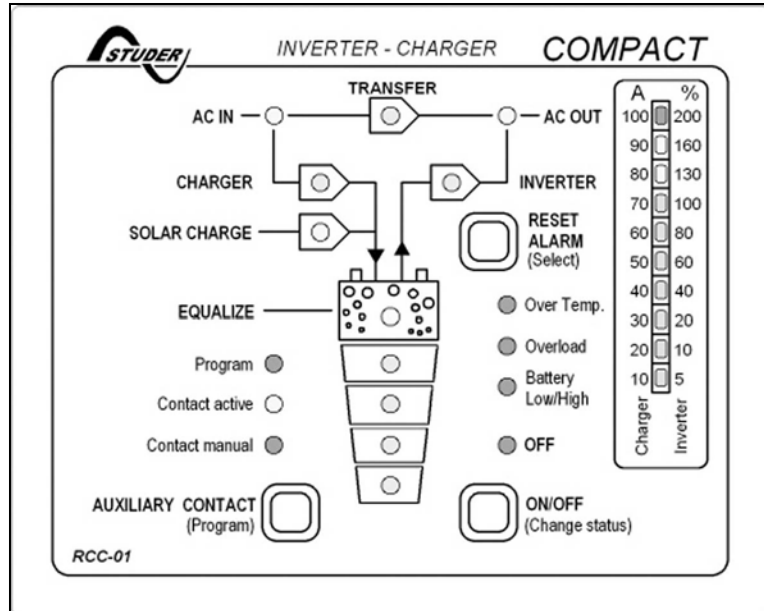

The output power and the charging currents are displayed on the Remote Control. In the Remote Control there is an additional Alarm Contact and a built-in Control Input. These two functions are available through Tip-jack RJ11/4 for use. This Auxiliary Contact is Front / Work Contact (max. 0.5A!), which is independent from the Auxiliary Contact of the HP-COMPACT. This contact is active in case of an alarm of the HP-COMPACT.

The Control Input is connected in parallel to the ON/OFF- push button. The HP-COMPACT can be switched on or off through this input with an impulse button or an impulse contact.

Caution: No external voltage should be connected to this Input Control.

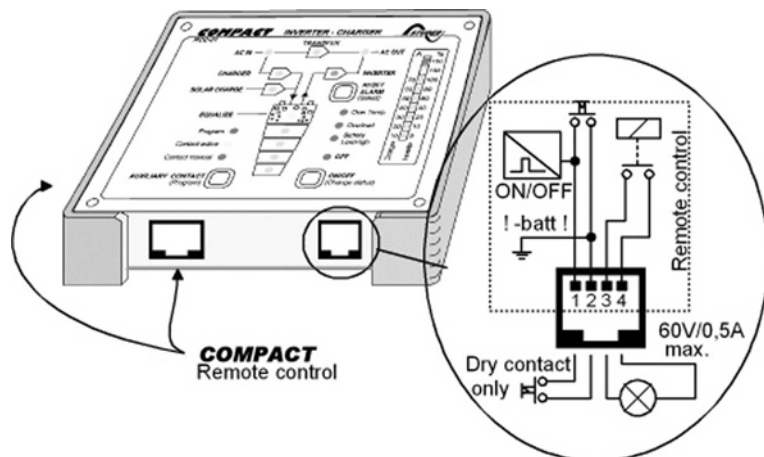

Order Number for Remote Control: RCC-01

Dimensions: H x B x T / 111.5 x 136.5 x 25mm

4.10 The Temperature sensor CT-35

Operating voltage of lead-acid batteries change depends on the temperature. To correct the operating voltages according to the



actual temperatures, a temperature sensor can be connected to the HP-COMPACT. The compensation through the sensor is $-3\text{mV}/^{\circ}\text{C}/\text{Cell}$.

Order Number: CT-35

Dimensions: H x B x T / 58 x 51.5 x 22mm

4.11 Remote control for „Power Sharing“ RPS-01

If the Remote control RPS-01 is installed, the Trimmer (26) “INPUT LIMIT“ has to be set on the value max.. The HP-COMPACT takes into account the lowest values set on the inverter and on the Remote control.

The current available at the HP-COMPACT input will be determined by the power of the connected source (generator, grid etc...). The potentiometer on the RPS-01 must be adjusted lower or equal to max. value of the power source.



For instance if the source is a generator of 2000 Watt, the potentiometer has to be set at max. 8A. This value is obtained in dividing 2000 Watt by 230V. If the HP-COMPACT is connected to a power source which is protected by a 6A circuit breaker, the potentiometer must be set at a max. value of 6A.

Caution: the HP-COMPACT will not limit if an appliance draws more current than available from the source ! This means that the connected generator will be over-loaded or that the circuit-breaker before the HP-COMPACT will break.

5 Programming

The HP-COMPACT (except for 60Hz versions) is equipped with a Flash processor fitted out with EEPROM Memory, which means that even when it is disconnected from the battery, the parameters that were programmed for the application remain after a new connection to the battery.

It is possible to reinitialize (RESET) the HP-COMPACT by pressing simultaneously on the three push buttons 19/20/21 during at least 2 seconds. A beep will confirm the RESET. The inverter switches off after this operation. It can be turned on again after the beep. The programmed parameters will remain.

5.1 Standard setting

The HP-COMPACT is delivered with the following default settings:

Auxiliary contact: active in case of defect or manual turn off with the LED 10/11/12/13

Battery voltage :	Low voltage	11.6V / 23.2V / 46.4V
	Float Charge	13.5V / 27.0V / 54.0V
	End of Charge Voltage	14.4V / 28.8V / 57.6V
	Equalization	15.6V / 31.2V / 62.4V

Absorption Time : 2 Hours

Equalizing Time : 20 Minutes

5.2 Reset value (default settings)

To come back to the default settings, press simultaneously on the push buttons 20/21 during at least 2 seconds. A beep will confirm the comeback to the factory settings. The inverter switches off after this operation. It can be turned on again after the beep.

5.3 Battery voltages and absorption time

5.3.1 Set the voltage and timing threshold

The programming is done in accordance with the following steps:

Push and hold down, the Push Button 21 (Program) and the Push Button 19 (Change status) for minimum 2 seconds simultaneously.

With the Push Button 20 (select) select which of the battery level and of the absorption time have to be changed.

These four red LED's show the function set:

Low voltage	LED 13 (ON/OFF)
Float charge	LED 12 (Batt. Low/high)
Absorption (End of charge)	LED 11 (Overload)
Equalization	LED 10 (Overtemp.)
Absorption Time	LED 10/11/12/13 (altogether)

With the Push Button 19 (Change status) set the desired parameter (voltage or time) to modify (LED 14/ 15/16/17/18). Push Button 19 (Change status) to set the desired value according to the table 5.3.2.

If desired, repeat the operation with any other parameter (voltage or time) to be changed.

If during 30 seconds no buttons are pressed, the selected values are automatically stored and the HP-COMPACT switches back in to the normal operating status.

The voltage levels and times changed through programming are only first active with the next charge cycle!

The voltage level which is not suitable can greatly reduce the battery life or could even destroy it ! Therefore check beforehand with your battery supplier.

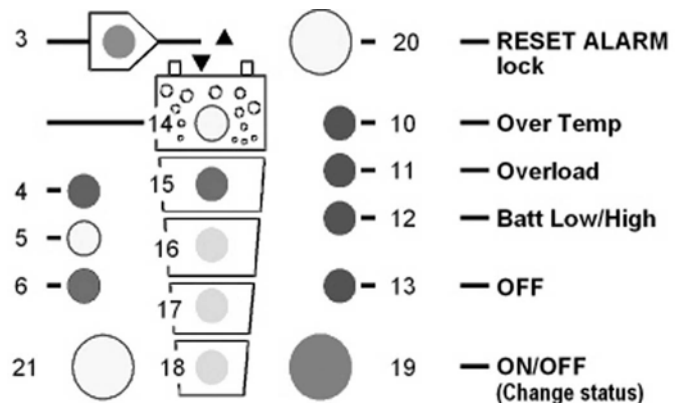

5.3.2 Table of voltage and timing threshold

The voltage levels (low voltage, float charge, end of charge and equalization) and the duration of the absorption charge can be changed.

The display of these voltages and the times in the program mode are in accordance with the diagram shown below:

LED	Low voltage			Float charge			Absorption			Equalization			Absorption time	Equalization time
	LED 13			LED 12			LED 11			LED 10			LED 10/11/12/13	LED 10/11
	12	24	48	12	24	48	12	24	48	12	24	48	12/24/48	12/24/48
14	12.0	24.0	48.0	13.7	27.4	54.8	16.2	32.4	64.8	16.2	32.4	64.8	4h	3h
15	11.8	23.6	47.2	13.6	27.2	54.4	15.6	31.2	62.4	15.9	31.8	63.6	3h	2h
16	11.6	23.2	46.4	13.5	27.0	54.0	15	30	60	15.6	31.2	62.4	2h	1h
17	11.4	22.8	45.6	13.4	26.8	53.6	14.4	28.8	57.6	15.3	30.6	61.2	1h	40'
18	11.2	22.4	44.8	13.3	26.6	53.2	14.2	28.4	56.8	15	30	60	0 – 1'	20'

The heavy printed values show the standard settings.

5.4 Auxiliary contact

5.4.1 Principle

The Auxiliary Contact can be basically programmed for any operating situation of the HP-COMPACT which is indicated with a LED. The programming is possible for one or more operating situations. If the contact is programmed for many situations, it is activated as soon as the HP-COMPACT finds itself in any one of the programmed situations. That means that the work of the contact meets that of the logic OR-Function.

5.4.2 The programming of the Auxiliary Contact

The programming of the Auxiliary Contact is carried out in the following Steps:

- The Push Button 21 (Program) presses down for min. 2 seconds. The LED 4 „Program“ is lit as an indication, that the HP-COMPACT is in program mode.
- A blinking LED shows the programmed condition for the auxiliary contact (LED 10/11/ 12/13 factory setting).
- With the Push Button 20 (select), select the desired condition in which the contact should be activated.
- With the Push Button 19 (Change status) confirm or change the status for this condition. If desired, with the Push Button 20 (select) select another condition in which the contact should be activated.
- With the Push Button 19 (Change status) confirm or change the status for this condition. If during 30 seconds no buttons are pushed, then the settled values are automatically stored and the HP-COMPACT switches back to normal operating condition.

5.4.3 Auxiliary Contact as generator starter

As per the battery capacity

When in the programming of the Auxiliary Contact, the Battery Capacity (LED 15-18) is used as a condition, you must then take note of the following requirements.

If you have to start an emergency back-up supply with a battery having a certain residual capacity, then two battery levels must be programmed. The first (i.e. Battery 25% LED 17) for the starting or activating the Auxiliary Contact and the second (i.e. Battery 100% LED15) for stopping or disabling the Auxiliary Contact. Programmed

like this the Auxiliary Contact works with the lowest set condition and stops when it has reached the highest programmed condition through charging.

Example: start of a generator with the HP-COMPACT

In order to program the auxiliary contact to start at 25% and to stop at 75% of the battery state-of-charge, here is the procedure to follow:

- Press the key AUX. CONTACT (Program) 21 during at least 2 seconds. Then the states will be displayed blinking (factory settings LED's 10/11/12/13). As these states are not wished for the start of the generator, they must be disabled.
- With the key (select) 20, select the LED's to disable (the active LED's are blinking) and disable them with the key 19 Change Status. Select the other LED's to switch off with the key (select) 20 and switch them off with the key 19 Change Status until all are disabled.
- Then select the LED 17 with the key (select) 20 and activate the contact with the key 19 Change Status. The generator will start once the LED 17 switches of.
- Then select the LED 16 with the key (select) 20 and activate the contact with the key 19 Change Status. The generator will stop once the LED 16 switches on.
- If no key is activated during 30 seconds, the normal operation states are displayed automatically again.

For a control the key Program can be pressed at least 2 seconds. The values set are displayed blinking.

As per the inverter output power (not available with some special executions)

Activating the auxiliary contact for the generator start can be programmed also on a pre-determined output power of the inverter. The auxiliary contact will be activated if the inverter output power exceeds 80% of the inverter nominal power during 3 minutes and/or 100% during 30 seconds.

The auxiliary contact will remain activated 30 minutes after the input current has come back to a value lower than the one adjusted by the "INPUT LIMIT" (chap. 4.6.4). In other words, the contact will be deactivated 30 minutes after the lighting out of the LED 200%.

This programming is achieved accordingly to chap. 5.4.2 of the user manual and by activating the contact on LED 100% of "Power Monitor" (25).

5.4.4 Power cut of the second priority loads

The auxiliary contact can also be used to cut the power of less priority loads when the battery state of charge is lower than a given threshold. In that case, only one of the battery state of charge, or the "transfer" function will be programmed as power cut criteria.

The second priority loads will be supplied only when the generator is ON or when the battery has a sufficient threshold.

5.4.5 Manual operating of Auxiliary Contact

The Auxiliary Contact can be operated at any time with the Push Button 21 (AUX. CONTACT). The LED 6 „Contact manual“ lights up as information that the Contact is manually operated, and LED 5 „Contact active“ lights up when the Contact is active. By pushing the Push Button 21 a second time, the Contact is disabled. By pushing it the third time, automatic functions are restored.

5.5 Disabling some of the HP-COMPACT functions

Each different function charger, inverter and transfer can be disabled. This is useful for specific applications witch required to disable some of these three functions.

If you press the buttons 19 and 20 more than 2 seconds you can have access to the different possibilities shown in the following diagram.

In programming mode the display shows only the different types of program with the three LED's 2, 7 and 9 to each function. To change the type of programming, press shortly the button 20 until you reach the right function used according to the table below. After 10 seconds the HP-COMPACT exits the programming mode and loads the new change.

In user mode, the disabled functions are displayed by blinking LED. So you can see which mode is disabled.

5.5.1 Diagram of the different modes

		All the functions are enabled. This is the factory setting.
		The inverter is disabled. Only the transfer switch and the charger will work normally.
		Inverter and charger are both disabled. Only the transfer switch function is enabled in input voltage and frequency is OK
		Charger and transfer switch are disabled the inverter will work continuously even if there is a correct AC voltage at the input.

6 Installation Maintenance

Apart from the periodic controls mentioned for the connections, the HP-COMPACT does need any maintenance. Keep the appliance clean and from time to time, wipe it clean with a damp cloth.

7 Declaration of CE Compliance

Hereby we state that the products described in this user manual comply with the following standards:

EN 61000-6-1, EN 61000-6-3, EN 55014, EN 55022, EN 61000-3-2, Dir. 89/336/EEC, LVD 73/23/EEC, EN 50091-2, EN 60950-1.

CH - 1950 Sion, the 31st of January 2002

STUDER INNOTEK (R. Studer)

8 Technical Data

Model	HPC 2800-12	HPC 4400-24	HPC 6000-48	HPC 8000-48
Inverter				
Nominal battery voltage	12V	24V	48V	
Input voltage range	9.5 - 17V	19 - 34V	38 - 68V	
Continuous power @ 25°C	2500VA	4000VA	5000VA	7000VA
Power 30 min. @ 25°C	2800VA	4400VA	6000VA	8000VA
Maximum power load 5 sec.	3 x Pnom			
Maximum load	up to short circuit			
Maximum asymmetric load	up to Pcont.			
Stand-by adjustment	1 to 25W			
Cos φ	0.1 - 1			
Maximum efficiency	93%	94%	96%	
Consumption OFF/Stand-by/ON	1.4/1.8/10W	1.7/2/16W	2/2.5/18W	2/3/30W
Output voltage	230Vac (- 10% / 0)			
Output frequency crystal controlled	50Hz +/- 0.05%			
Total harmonic distortion	< 2%			
Dynamic behaviour on load change 0 to 100%	0.5 ms			
Overload and short circuit protection	Automatic disconnection with 3 time restart attempt			
Overheat protection	Acoustic warning before shut-off - with automatic restart			

Battery charger (4 STEP) I-U-Uo-Equalize (every 25 cycles)

Charging current adjustable	0 - 110A	0 - 100A	0 - 70A	0 - 90A
Input current balance adjustment (Power Sharing)	1 - 30A			1 - 50A
Maximum input voltage	265Vac			
Minimum input voltage	Adjustable threshold from 150 to 230Vac			
Input frequency	45 - 65Hz			
Power Factor Correction (PFC)	EN 61000-3-2			

Battery control (thresholds and times adjustable by the user)

Absorption time	0-4 h			
End charge cycle voltage	14.4V	28.8V	57.6V	
Floating voltage	13.6V	27.2V	54.4V	
Equalization voltage	15.6V	31.2V	62.4V	
Deep-discharge protection	10.8V	21.6V	43.2V	
Temperature compensation (optional CT-35)	-3mV / °C / cell			

General data

Multifunction contact - potential free (3 points)	16A - 250Vac			
Max. current on transfer relay	30A/6.9kVA			50A/11.5kVA
Transfer time	< 20 ms			
Weight	33 kg	39 kg	41 kg	45 kg
Dimension h x l x L [mm]	242x288x480			242x288x500
Protection index IP20	IP 23			
CE conformity	EN 61000-6-1, EN 61000-6-3, EN 55014, EN 55022, EN 61000-3-2, Dir. 89/336/EEC, LVD 73/23/EEC, EN 50091-2, EN 60950-1			
Operating temperature range	-20 to 55 °C			
Ventilation	from 45 °C			
Acoustic level without / with ventilation	< 10 dB / < 35 dB			
Warranty	2 years			

Options

Remote control (112 x138 x 25mm / 20 m cable)	RCC-01
Remote power sharing (20 m. cable)	RPS-01
Battery temp. sensor (58 x 51.5x 22mm / 3 m cable)	CT-35

Data may change without any notice

Free Manuals Download Website

<http://myh66.com>

<http://usermanuals.us>

<http://www.somanuals.com>

<http://www.4manuals.cc>

<http://www.manual-lib.com>

<http://www.404manual.com>

<http://www.luxmanual.com>

<http://aubethermostatmanual.com>

Golf course search by state

<http://golfingnear.com>

Email search by domain

<http://emailbydomain.com>

Auto manuals search

<http://auto.somanuals.com>

TV manuals search

<http://tv.somanuals.com>