

SV Subwoofers

OWNERS' GUIDE

SVS PB1-Plus Powered Box, Single Driver Subwoofer

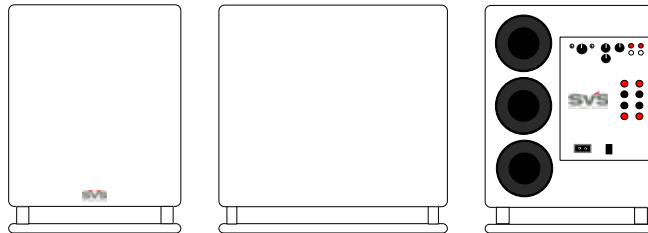

SVS
The Bass Authority

Contents:

- Page 1 Welcome
- Page 2 About your new SV Subwoofer
- Pages 4- 7 Setup, integration, and calibration
- Page 7- 8 Powered box amp features
- Pages 9 - 11 Parametric equalizer (PEQ)
- Pages 12 - 13 Variable tuning
- Pages 14 - 15 Bass demos

Last update: 27 January, 2004

Welcome.

From the entire SVS team, congratulations on your purchase of *the* standard in home theater and music bass!

Your new subwoofer isn't some generic, mass-produced box built someplace you can't even find on a map. It's made in Ohio (USA), by home audio enthusiasts... like you. Designed, tested and assembled by hand, while using state of the art automation and materials, your SVS is without a doubt one of the best investments you'll ever make in bringing music and theater *home*.

What's more, we'll help you to set up your sub right, and in no time, you'll be giving "demos" of your favorite music, DVDs or digital music to all your friends and neighbors (we pity them if you live in an apartment...please, be kind!). This isn't just a "subwoofer" after all, it's a carefully designed audio component carefully tuned in our labs, by bass authority and "Sub-human", Tom Vodhanel.

You're unlikely to have heard, or felt, bass like this before, unless it was in a top-notch commercial movie theater or high-end (high cost) audio boutique. Movies and music in your home will never be quite the same again. That's a promise.

Already have a question about your sub? You might answer it by reading this manual; we think you'll find it more informative than most. For even more detailed discussion about set-up topics check out our **FAQs** page at www.svsubwoofers.com. We touch on all the key points you need to know, and then some.

Maybe you just want to share a bit of bass news? Or perhaps you have a story about your SV Subwoofer to share with us? Maybe something we missed in our website? No matter, feel free to send a note straight to me: rons@svsubwoofers.com.

It's not often you can talk to the guys who made your audio components. In this case, we look forward to it.

*Ron Stimpson
Co-Founder SVS*

About your SV Subwoofer

Other subwoofers might look like them — but virtually none *work* like them. Not at this price. SVS's are decidedly different, in how they are designed, produced, sold, and even in the exceptional customer service after the sale. No surprise then, you could have spent *much* more and *still* not come close to the value and performance our **Powered Box** lines provide. But what makes a subwoofer an *SVS*???

Quality parts, sane prices. You might be surprised at how inexpensive the components in most *not-so-inexpensive* subwoofers might be. At SVS we scour the earth for the best, most cost effective parts (the few we don't make ourselves), and meld them into finely tuned designs that define high performance home theater and music bass. Still, cost is always the *second* consideration at SVS. Want woofers, amps, or even binding posts? We've tested and discarded plenty that didn't meet our tough standards. If we use it, whatever "it" is, you know it made the grade.

Get "cube-ular". Many we've seen are simply poorly made. We did a host of studies that optimized the materials, the size, and even the enclosure finish to ensure a rigid design that was still compact for its performance and able to take the abuse your family and friends can dish out. Proudly "Made in the USA", like most other SVS parts, the cabinet is no *ordinary* box. Selling direct means your sub, and not glossy ads, gets first priority. SVS is quality you can *hear*.

Stable downward firing woofer. Our contemporary enclosure design is one plus, but we've also taken great lengths to allow for downward firing woofers. Coupled with our unique base-plates, which minimize driver reactive forces, you'll find our subs can take a tremendous amount of power and remain rock solid. Compliant rubber feet on allow for stable placement on a variety of surfaces. No rattling, or buzzing allowed!

Custom low turbulence port designs. When you listen to your trend-setting ported sub you'll hear (and feel) bass like never before, with an exceptionally low noise and distortion. Huge, patented flared port fittings make the difference! One DVD or music CD and you'll realize something special went into this product.

Stylish, and understated. From the hand-finished American wood craftsmanship of the box, to the elegant base, you'll be amazed at how easy it is to lose your sub in a corner. SVS's aren't tiny, but this is one of those times size *does* matter. There are countless brands of "wannabe" subs out there. Fortunately, you didn't just unpack one.

World-class power. Our Canadian-built amps are manufactured with a level of fit and finish, plus a collection of features and power practically unheard of at this price. Did we mention power? It's there *in spades* (though we rate them conservatively). And SVS starts with efficient subwoofer designs which don't require significant levels of power-robbing equalization to go low and flat. So our amps can work harder at reproducing low frequencies, instead of struggling against a lack of enclosure space (the bane of clean, deep bass). As a result, we don't require the megawatts some subs do, instead running cool and reliable in our vented enclosures. These digital hybrid amps run *so* cool, we can even dispense with old-fashioned "cooling fins"!

Setup, calibrating and integration

What's to know? Well, first of all, setting up an SV Subwoofer is pretty darn easy. There are a few key things to get right if you want to get the most out of your new equipment however!

Unpacking. You're probably eager to fire up your sub (we're the same way), but take time to carefully unpack your sub. Set the box and other protective shipping materials aside; saving them in case you ever need to return the subwoofer for any reason. Fold your box flat for storage even.

Location. They say it's *all* about location right? It's the same with setting up your subwoofer. So, where to put it? **Go for a corner** if you can, and avoid putting your sub where it might adjoin large open areas. Studies have shown the deepest and flattest bass response is typically attained when a subwoofer is placed within a few feet of one of your room's corners. Whether you put the sub in front or to the rear of your seating area usually makes surprisingly little audible difference. Deep movie and music bass, like that from Dolby Digital (DD) "5.1 channel" DVDs and digital audio is largely non-directional. You can't tell where it is coming from, even though you can hear, and feel it.

Hook-up (see Fig. 1). There are a variety of ways to configure your new sub. Usually, a simple mono, shielded 75 Ohm A/V RCA type cable (a.) is used to take the subwoofer output of your DD/DTS surround sound receiver (b.) and feed the low-level input of the sub's amp. There is no need to "split" the signal going to the sub (c.). You can feed either one of the two amp inputs, it doesn't matter, right or left.

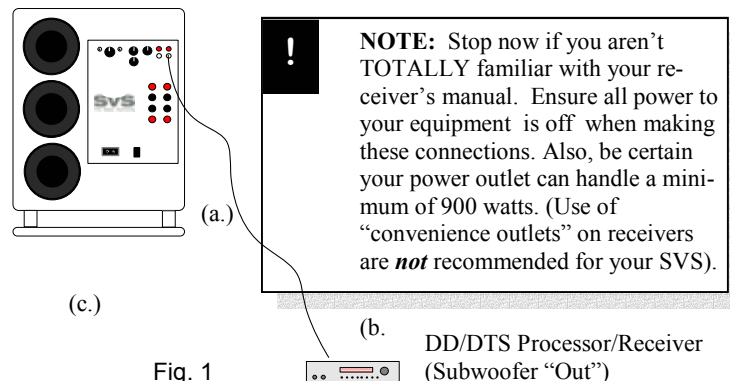

More Setup, calibrating and integration

If you are running a pair of SV Subwoofers (Fig. 2), you will need to use a standard “Y” cable adapter (d.) The best adaptor to use for this task has one male RCA connection and two female RCA outputs. (Radio Shack® stocks them.) From the “Y” cable you can run a standard 75 Ohm RCA to RCA signal cable (e.) to each sub, thus “splitting” the Low Frequency Effects (LFE) and other bass signals from your receiver and effectively feeding both subwoofers with the same signal.

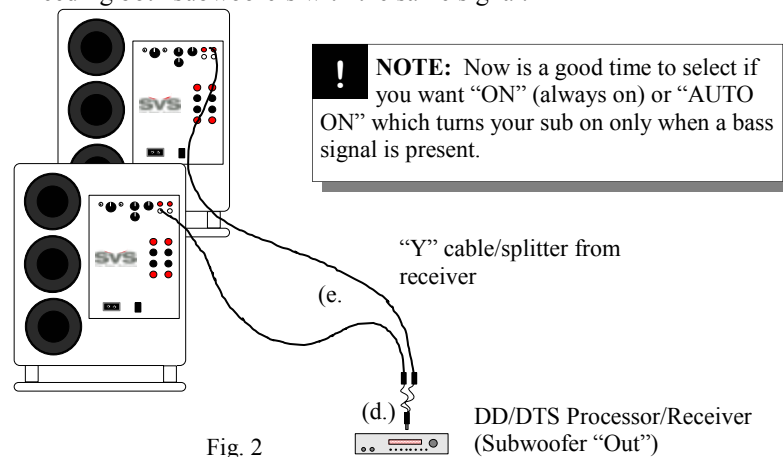

Fig. 2

“Calibration”: This isn’t only for tech minded folks, it’s *critical* to a proper configuration of your home theater sound system. Fortunately, adjusting channel balance (or, calibration) is as easy to do as it is important. The first order of business is making sure your DD/DTS surround-sound system is set up properly. We recommend you consult your audio/video receiver (or processor) manual to refresh on the procedures to do this. Generally, this requires ensuring the receiver’s test tones, or a special test disk (like *Video Essentials* or *Avia*) play back at the same volume from each of your system’s full range speakers. That’s left, center, right, left surround and right surround (and if equipped, center rear) speakers, plus the subwoofer. (More on sub level in a second). Skip to page 7 (“Powered Box Features”) if you aren’t familiar with your sub’s amp, and come back to calibration.

Some things to check as you get ready to calibrate:

- **Are your speakers set to the correct “size”?** Your receiver/processor should allow you to indicate if your speakers are “Small” or “Large”. Selecting the size accordingly will ensure bass goes to most appropriate speakers, and use the subwoofer correctly too. In most instances set-

ting ALL speakers to “Small” works best. Let your sub make the bass! Also, is your subwoofer turned “ON”? We don’t mean “is your subwoofer *amplifier* on?” (that’ll be important later too) but rather, **is your receiver sending a bass signal to your sub amp?** This can only happen if you say “Yes” (or “ON”) in the “Subwoofer” selection during the all-important setup menu of any typical Dolby Digital/DTS capable receiver. If you have a choice of “crossover points” for your bass, usually “80Hz” works best, unless you have unusually small main speakers.

- **Is your receiver connected to the sub amp?** Use a well-shielded RCA cable (sometimes called a “patch cord”) to connect the subwoofer output of your DD/DTS receiver to *either* input jack of your subwoofer’s dedicated amplifier. As mentioned earlier, you’ll need to “split” the bass signal with a “Y Cable” if you bought a pair of subs. You only need feed *one* of the two inputs (either Right or Left) of any single Powered Box SVS however.
- **Is your Radio Shack ® sound pressure level (SPL) meter ready?** This tool is simply *vital* to proper home theater audio setup. It’s akin to a tire pressure gauge for your car. The manual which comes with the SPL meter is excellent; we recommend you read it entirely. Haven’t got the meter yet? Head down to your neighborhood Radio Shack ® and snag one. We prefer the analog instead of the digital display model but both work well. Ask for part number #33-4050. At about \$40, it’s a bargain. Proper configuration *without* this meter is practically *impossible*.

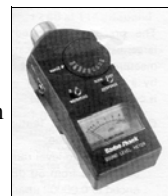

Getting ready to start now: Make sure your receiver/processor master volume is set at “00 dB” or some other easy to remember reference level. Finally, ensure your SVS’s volume control is set no more than 1/4 to 1/3rd up at first. It’s also critical to check the subwoofer level control of your surround receiver before you begin the test tones. Set it to no higher than “-5 dB” initially (that’s one quarter way up, given a typical receiver’s subwoofer channel level limits of -10 dB to +10 dB). Your LFE “trim”, if you have one, should be set to 0dB to start (that’s full up) but this can be dialed down later to tame peaks if needed. IMPORTANT: Turn off ANY sound-field processing modes, “peak limiters”, “mid-night mode” etc. Set the SPL meter to “Slow” and “C-weighting” (turn the range dial to 70dB).

Now play your receiver’s internal test tones so you have something to measure with your SPL meter. Better yet, buy a calibration disk, such as the *Video Essentials*, *Sound and Vision HT Tune Up*, or *Avia* DVDs. A test disk’s tones ensure your entire signal path, from the DVD player to your speakers, is set correctly. Whatever you use, when the tones start alternating from speaker to speaker (watch your sound meter now), set each full range speaker’s level to about 75 dB (or 85dB if using Avia or S&V), by using the receiver’s dedicated channel controls (leaving receiver’s master volume the same). We recommend you turn down the receiver’s subwoofer output level *before* you significantly lower your sub’s volume/gain control. This helps keep input distortion to a minimum. You should *not* be set much lower than -5 dB however, since some adjustment room is needed to lower bass as needed. If your subwoofer reading is still too high then turn down the sub’s amp volume a little with each run.

But what's "too high"?? Tastes vary, and so do movie soundtracks, but your SVS is capable of *tremendous* levels of low distortion, low frequency bass — far more than most commercial subs. Take advantage of this, especially if you like action movies with lots of “.1” channel (LFE) action, and give the sub a bit more “bump” during calibration (also known as running the sub “hot”). Keep in mind too that the human ear is relatively insensitive to low frequencies. This, coupled with the fact most folks don't watch movies at Dolby Digital theater reference level (loud!), means turning the bass up a few decibels usually yields a better movie sound experience.

What sub levels do we recommend? If you watch movies at relatively moderate sound levels, a good start is a range of +2dB to +3dB above your other channels (as measured with your sound meter). This means the test tone will waiver about 78 dB for the subwoofer portion of the calibration run (88dB with Avia). (**Note:** You may want to rotate the sound meter SPL meter dial to 80dB to get a good reading with these higher levels.) Note too that many modern surround sound receivers allow a variety of different subwoofer level settings, depending on the “listening mode” you are in. With “Dolby Digital” as your “mode” use the above calibration routine. You may well find that CD “Stereo” music calls for a lower bass settings. The above is a guide... experiment some. The louder your master volume though, the more you should back off the sub level to compensate. Avoid your driver bottoming, resulting in a loud “clack”!

Location and measurement. You should take the above measurements from your typical preferred seat for watching movies (center cushion, right?). Be advised, strong bass levels can vary *significantly* simply by moving a few feet. Such is the nature of long wave-length, low bass sound. Try different locations and different levels for your subwoofer. Calibrating with the subwoofer's volume too high (and often, too low) is the most common subwoofer setup error!

Powered Box Features. We looked the world over for the best sub amp that's still affordable. In the end we designed our own. The result? A custom, North American-made amp with amazing build quality, durability and unbeatable features.

Volume/Gain Use “gain” (in conjunction with your receiver's subwoofer output level control) to dial in a bass calibration to your liking. Start calibration with the sub's volume/gain no more than 1/4 to 1/3 of the way up (turned clockwise from the left).

Crossover Frequency. If you use your DD/DTS receiver/processor's internal crossover to manage bass frequencies (highly recommended), the setting of this knob on the sub is irrelevant. (Note: Use the SVS's crossover “Enable/Disable” switch discussed below to take advantage of this configuration.) Otherwise this knob is used to best blend your SVS to your other speakers. Typically used in stereo only systems today.

Phase. Think of bass waves as conflicting or enhancing each other, depending on the timing of their arrival at your listening location (either together, or not). Since some of your room's bass might come from main, center and/or surround speakers, as *well* as

your sub, getting these bass wave forms to arrive in a complementary, *enhancing* fashion is the difficult job of the phase control. Essentially, “phase” varies the timing of the bass waves coming from the sub. But don’t despair if you don’t hear much difference with changes to the phase knob — the effect of bass cancellation will vary by volume and frequency in your room, and no single setting is likely to ever be “perfect”. One simple technique to optimize phase is to find a nice “bassy” loop (such as the menu of “Godzilla”) and measure the loop’s SPL response at various bass peaks. As the loop runs, you can have an assistant adjust the phase control. When you see the most response on a given bass passage, typically that’s the setting with the least room-induced cancellation (for the frequencies of the demo loop).

Line In/Out. Use one of the sub’s “Line In” jacks to connect the subwoofer to the output jack of your receiver/processor. Feeding just one input is enough. If you are using a conventional amp and/or a stereo setup you can use the “Line Out” jacks to send sound (filtered of deep bass information) back to your system amp. A simple RCA to RCA cable is all you need for either type configuration.

Auto On. Your sub allows an “Auto On” mode... or can be on all the time. With the switch in the “Auto” position your subwoofer will “sense” that a DVD or CD etc. has begun and switch on immediately (the “hard power switch” mentioned below must be on, naturally). A few minutes after a movie finishes, the auto-on light will turn red, switching the sub back off. When running (and sensing a signal) the auto-on LED will be green. Sometimes, with very low listening levels, your subwoofer might not get enough of a bass signal from your surround sound processor to “trip” the auto-on circuit. Should you ever find this to be the case you may leave this switch to “On”, or turn the receiver’s subwoofer output *up*, and the sub *down*.

Crossover enable switch. If you allow your DD/DTS surround-sound receiver or processor to manage bass frequencies (recommended), this switch should be set to “Disabled”. This eliminates the effects of the “Crossover Frequency” knob and allows your sub to reproduce just what it’s fed from the receiver. If you use the sub in a two channel (stereo only) configuration, then “Enable” the crossover and adjust the knob to best blend the sub into the low frequency output of your speakers.

High level inputs/outputs. Not commonly used today, but binding posts are there in case you don’t have low-level inputs/outputs on your receiver/processor. Typically utilized only if you are *not* using a DD/DTS compatible system.

Power. This heavy duty two-position switch next to the power cord will completely cut the power to your sub amp. Flip this switch to off *before* you ever move the sub or change inputs or outputs.

A/C connection. Plug your sub into a dedicated A/C outlet. “Convenience” outlets of typical receivers often don’t provide the needed current. Avoid them.

Fuse. User replaceable, contact SVS if you have trouble finding one. The fuse can be accessed by a small round door immediately next to the power cord fitting.

Parametric Equalizer. Important enough and challenging enough, this feature gets its own section! “PEQ” allows you to tame a “peak” in your room’s response. Peaks are quite common, especially in large rooms or ones where your sub is far from your listening position. **NOTE:** A Sound Pressure Level meter is a *must* for proper use of the PEQ, so get one before you tackle this control. **TO DISABLE THIS CONTROL:** Set the “LEVEL” control in the Parametric EQ feature grouping until it stops on “MIN” — thus ensuring you do not inadvertently cause poor frequency response until such time as you properly configure the PEQ.

First you might ask yourself, “why use a PEQ?” The reason is quite simple. Your room. See, most times even a superlative subwoofer which measures very evenly (we say “flat”) in an open domain (no reflective boundaries) will *not* measure the same in your home theater or music room. Instead, colliding bass waves can build up and cause a “peak”. This is where a parametric equalizer helps out. A PEQ is an electronic circuit which allows the user to manipulate the input signal so the acoustical output is more desirable for their environment, in many cases allowing the worst peak to be “flattened”. By manipulating the input signal with your PEQ you can cut a wide or narrow peak in response located somewhere in the frequency range of the equalizer. Importantly, the equalizer found your sub only allows reduction of peaks, and is “cut only”, not a boost device.

Measure the room’s response. As indicated above, you must have a firm understanding of your room’s acoustical properties before you proceed with use of a PEQ. To determine your room’s natural response properties (along with your subwoofer’s, in that room) you will need an SPL meter as described on Page 6, and at least a pad of graph paper and a pencil for charting as below. If you have graphing program similar to Microsoft Excel® this will save some time graphing the response curves. The last item to correctly measure the room’s response is a test disc that can play specific frequencies. The disc should contain frequencies from 20Hz to 100Hz. One of the most popular frequency tests discs is *Autosound 2000 CD #101*. It can be found at www.carsound.com/cds.shtml and is quite inexpensive.

Freq	20	25	30	35	40	45	50	55	60	65	70	75	80	85	90	95	100
SPL	85	84	86	91.5	95	90	84	84	86	86	85	83.5	83	83.5	84.5	85	86

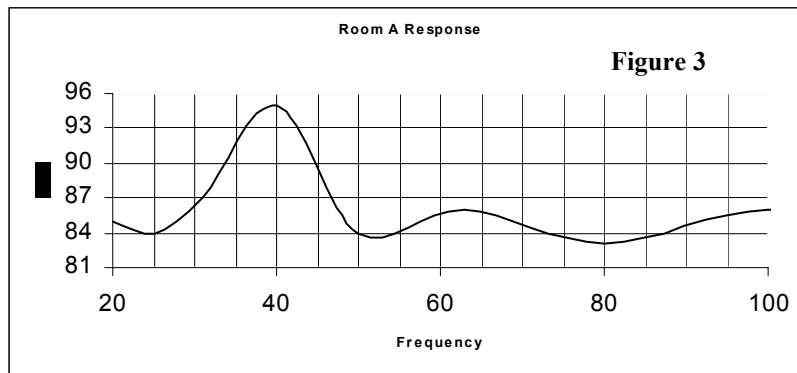

This disc allows the user to play 10Hz through 98Hz in one hertz increments allowing very good resolution over your measurements. Other good examples for test discs are *Avia's Guide to Home Theater* and *Digital Video Essentials*. When measuring the room's response use a minimum resolution of 5Hz. *Figure 3* on the previous page shows a theoretical illustration of a room's response.

Before you plot your results however, it's important to note the Radio Shack sound meter is not totally "linear" in its accuracy down low. All similar meters are off by the similar amount depending on the frequency; so while its sensitivity below 20Hz is not what it is at 50Hz, there is a simple way to compensate for this deficiency. It's called a compensation chart.

Simply look to the below frequencies and add the required decibels (dBs) at the frequency in question. So if your system seems to be measuring 70dBs with a 20Hz tone, then really it's putting out 77.5dBs. This is a VERY substantial difference, roughly TWICE the acoustical energy, requiring several times the amplifier power to achieve. You can see then how critical the below chart is if you are using your PEQ to even out or "flatten" the room response of your bass.

Add the following to your measurements:

10Hz add 20dBs
 12Hz add 16.5dB
 16Hz add 11.5dB
 20Hz add 7.5dB
 25Hz add 5dB
 31.5Hz add 3dB
 40Hz add 2.5dB
 50Hz add 1.5dB
 63Hz add 1.5dB
 80Hz add 1.5dB
 100Hz add 2dB
 125Hz add .5dB

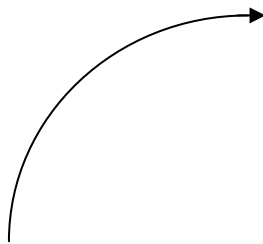

SVS PEQ Controls

Explanation of the controls. Now that we understand how to measure the room's response the next step is to correct the problem areas with the parametric equalizer. Before we start turning the controls we need to understand what the adjustments are and how they work (the controls of your PB1-Plus will be arranged different than pictured).

“**Q**”. This control determines how wide the correction will be. Each “hash mark” on the amp's front plate represents 0.1 octave adjustments. The “**HI**” mark is equal to 0.1 octave (narrow) and “**LO**” mark is equal to .9 octave (wide). In *Figure 3* the highest peak is located at 40Hz and becomes flat again at 50Hz (the Highest Frequency of the peak). To determine the Q adjustment the following formula is needed. More on “**Q**” in a moment.

$$\text{Formula 1} \quad \frac{(\text{Highest Frequency [X]} - \text{Center Point [Y]})}{\text{Center Point (Y)}}$$

The **LEVEL** control is the amount of attenuation on the signal located at the center frequency. **MIN** is equal to 0dB and **MAX** is equal to -12dB “cut”. Each hash mark reduces the Center Point in question by 1.5dB.

The “**FREQ**” control (short for frequency) is the adjustment for the center point of the cut and should target the highest peak frequency in the room’s response. Each hash mark for this control moves the center frequency for the desired cut 5Hz, within a range of 20-80Hz.

Adjustments of the parametric equalizer. The first step to adjusting a PEQ is determining the “**Center Point**” of the cut. Determining the Center Point allows us to establish a target, or baseline, for further adjustments. In this example (again, looking to the graph in *Figure 3*), the peak frequency is roughly 40Hz.

At this stage we’ll estimate the beginning (lowest frequency) and the end (highest frequency) of the peak. In *Figure 3* the beginning would be located somewhere near 25Hz and the end, or **Highest Frequency**, would be near **50Hz**. This would be a 25Hz bandwidth, with a **Center Point** located at **37.5Hz** (the midpoint between 25 and 50Hz). Notice that the center point of 37.5Hz is **not** located precisely at the peak frequency in the response curve, which was estimated at 40Hz. Why? If we used 40Hz as our center frequency and 50Hz as our high point cutoff we would only attenuate the curve down to 30Hz. This will leave a small bump in response near 25Hz because the correction would only be located between 30Hz to 50Hz.

Now that we determined the Center Point we can adjust the “**FREQ**” control knob to 37.5Hz, or between the fourth and fifth hash marks, clockwise from the left.

The next step will properly adjust the “**Q**” setting. We again need to use *Formula 1* and calculate the **Q** setting from *Figure 3* using Highest Frequency and Center Point figures just determined above.

$$\frac{50\text{Hz} - 37.5\text{Hz}}{37.5\text{Hz}} = 0.33$$

.33 Q ... or just past the third hash mark, clockwise from the left of this control.

Now that we have successfully adjusted the **Q** and **Frequency** controls, we need to make the final **Level** adjustment. In *Figure 3* the adjustment should be somewhere near -10dB to -11dB, or on the 8th hash mark from the left (1.5dB cut per hash mark), completing the adjustments for the parametric equalizer.

Measure room response for accuracy. After all the adjustments are made we recommend you measure the room again to make sure the adjustments are correct. If the new response curve is not acceptable then fine-tune things some. For example, if the response curve still shows a small peak you should adjust the **Level** control again to compensate. Make sure your overall SPL calibration is set as described earlier in this manual, and enjoy your optimized subwoofer!

Subsonic Filter and Port Tuning

Your new PB1-Plus subwoofer not only comes with our “Tri-Power” port flares, but **custom port plugs** and **variable subsonic filter** which allow your sub to be “tuned” to even lower frequencies than its stock configuration. For most people and most rooms, your SVS is already configured for the best blend of extension (how deep/low your sub goes) and output (how loud it gets at a variety of bass frequencies). However, we know that bass is a very personal taste and no two rooms will react exactly the same with any subwoofer. So we include a custom “port plug” that, when inserted into a port, allows you the user to experiment with a substantially lower “tune”.



As with all such devices, there are compromises when tuning a sub lower. Installing a port block takes some capacity from upper reaches of bass, installing *two* port blocks naturally limits upper bass response even more. So while you will indeed get more bass down low (where DVD and music bass is more rare, but quite exciting!), you’ll sacrifice total output capacity above the stock tuning point of the sub (where bass is more common). You should decide if the effect is pleasing on the sorts of movies and music you enjoy.

How to do it? To insert a port plug, simply squeeze the foam on one end and press the plug into a port flare until it is about 1” lower than the edge of the surface of the sub. You can remove the plug by inserting your fingertips into the port flare and squeezing and pulling on the foam plug at the same time. Be sure to select the subsonic filter point on the back of your PB1-Plus amp which coincides correctly with your new “tuning point”. **NOTE:** We strongly recommend you do **NOT** run a lower subsonic filter point than your port plug configuration would dictate — especially if you are running the subwoofer at high sound pressure levels! Moderate levels are doubly important if you put the subsonic filter into the 12Hz mode (essentially turning off this key limiter). This simple table indicates the settings you should use in setting up your sub blockers and the subsonic filter knob.

PB1-Plus Tuning Chart	Subsonic Filter Knob
Stock tune (no ports blocked)	25Hz
With one port-blocked	20Hz
With <i>two</i> ports-blocked	16Hz

Look to the next page for a computer simulated response chart showing the reduction of upper bass when adding one, and then two port-blockers to your SVS (along with addition woofer excursion needed to keep up with the lower frequencies). The bottom line? Many customers feel the slight loss in upper bass output to be insignificant compared to the deeper response the port block gives. We let you decide.

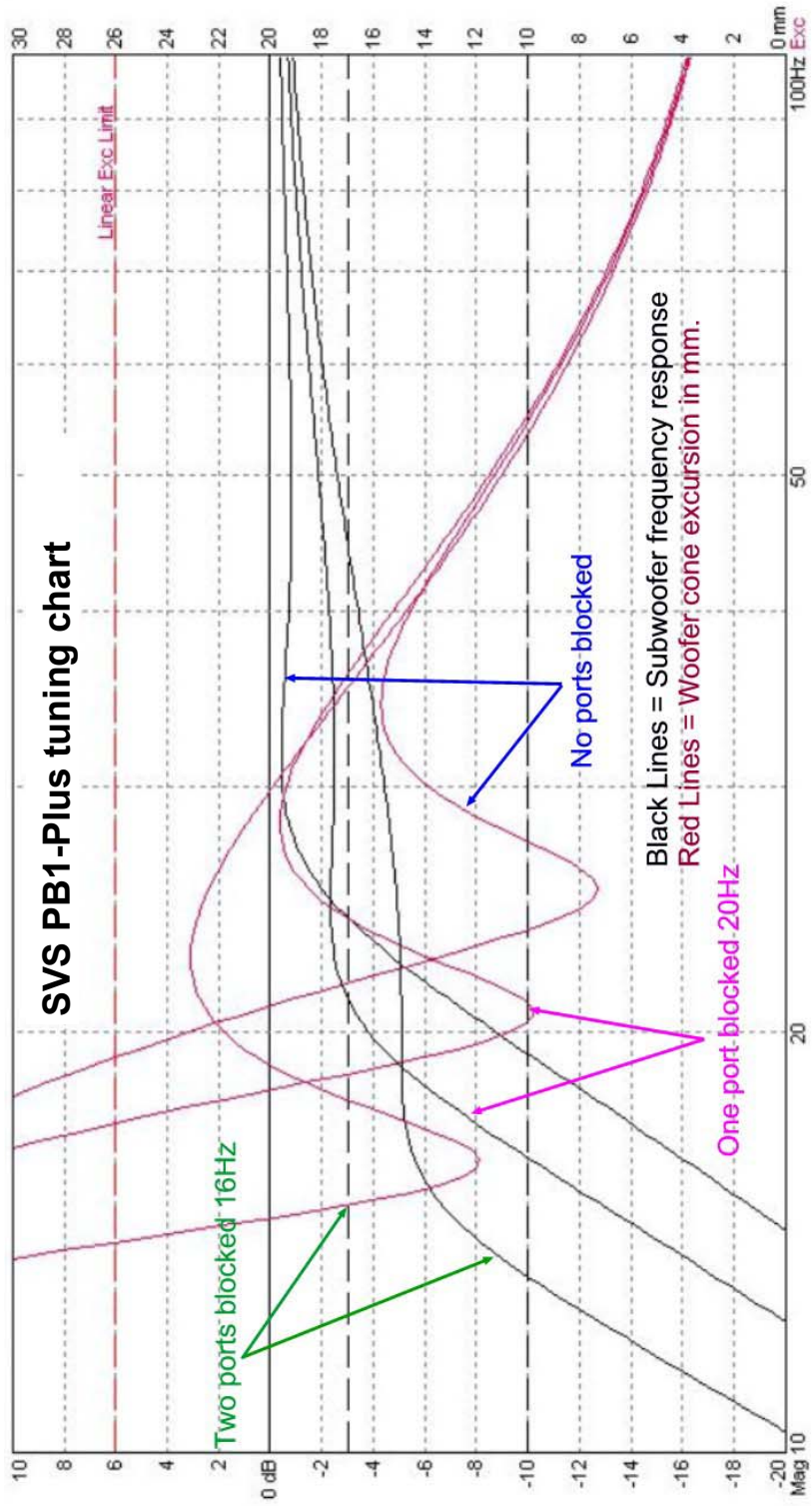

Bassy demo scenes to die for.

So now what?? You've got one of the best theater and music bass sub-systems on the planet, you're calibrated...want to see what she'll do? **But of course!** Since finding those scenes can be a bit trying, we've compiled a list of our old favorites below. After all, calibration with test tones is important, but it's movies and music this sub is itching to show off. Chapter stops for DVDs are shown, with movie time in hours: minutes: seconds. What are you waiting for? Just hit **PLAY!**

- **“The Iron Giant”** Great family animation with SERIOUS bass, including strong peaks below 25 Hz. Jump to:
 1. “Chase thru the forest” Scene 8 (20:00 into the movie)
 2. “Robot Landing” (Train Impact) Scene 10 (25:40)
 3. “Green Boom” Scene 27 (1:11:40)
- **“Antz”** Another good family movie, though not perhaps for small children. Extremely loud bass above 30 Hz.

“Terror from Above”, Scene 17 (51:48)
- **“The Matrix”** Modern, violent, science fiction classic with plenty of shoot-'em-up bass blasts. Here's some subtle and not so subtle.
 1. “Where we are grown”, Scene 12 (42:55)
 2. “Landing in fight”, Scene 15 (50:51)
 3. “Chopper shootout”, Scene 31 (1:47:15)
- **“Das Boot”** Arguably one of the most compelling war pictures of all time with bass approaching 20 Hz. Very loud, very deep.
 1. “Depth charges”, Scene 21 (59:30)
 2. “Storm surfing”, Scene 25 (1:15:15)
 3. “Hitting bottom”, Scene 17 (53:15, Side “B”)
- **“Apollo 13”** Moving story, with some surprisingly subtle but revealing bass where it counts.
 1. “Lift off”, Scene 13 (35:15)
 2. “Coming home”, Scene 53 (2:05:43)

More Bassy demo scenes.

- **“Titanic”** You love it...or you *hate* it. Regardless of which side of the ship you sit on, this flick does some serious rumbling for you:
 1. “We can’t leave him” Scene 22 (2:21:50)
 2. “Ship Splitting” (2:41:30)
 3. “Last Gasp” (2:42:05)
- **“Blade”** Not one for the kiddies, but loaded with deep bass.
 1. “Footstep”, Scene 4 (7:15)
 2. “Door blown” Scene 20 (50:05)
- **“Aliens”** Not just another modern sci-fi horror classic, this one rocks from intro to final scene.
 1. “Ship drop”, Scene 9 (41:20)
 2. “Awakenings”, Scene 15 (1:12:52)
- **“Apocalypse Now”** Making This Vietnam war movie, Francis Ford Copolla nearly went crazy...imagine what it'll do to your subwoofer!
 1. "Chopper ride" Scene 2 (0:19:47)
 2. "ARC LIGHT" Scene 4 (0:26:02)
 3. "Grenade launch" Scene 12 (1:27:58)
- **“Contact”** SETI with a (bass) twist or two along the way.
 1. “Bombing”, Scene 28 (1:36:30)
 2. “Space truckin”, Scene 33 (1:55:56)
- **“Dark City”** One of Roger Ebert’s favorites, think he likes bass too?
 1. “Let the tuning commence”, Scene 8 (34:30)
 2. “City makeover”, Scene 15 (1:27:45)

Warranty:

45-day money back warranty. If you are not completely satisfied with the performance of your subwoofer, return it to us for a full refund of the purchase price. Just a few minor stipulations should you choose to do this:

- The subwoofer must be returned in original shipping box.
- E-mail SVS first for a return of merchandise number (RMA) and display this on the outside of the box.
- The sub must be insured during shipping (SVS may arrange UPS pickup to ease any shipping damage issues).
- Shipping costs are not refundable.

3 year warranty against defects in materials and workmanship. SVS will repair or replace any item at its discretion and return to the customer as soon as possible. Naturally, this warranty does not cover any product subjected to misuse, abuse, or accidental damage discovered by SVS.

Except as provided above, *SV Subwoofers* makes no other warranties express or implied. Some states do not permit limitation or exclusion of implied warranties, so exclusions may not apply to the purchaser.

The bottom line: We're proud of these subwoofers and want you to be as happy owning one, as we are selling one (or more) to you. E-mail us if you have any warranty question.

SV Subwoofers	
SV Subwoofers LLC 365 Stone Harbor Road Holland Michigan, 49424	
Fax: 216-803-0195	
Phone: 703-845-1472	
Email: custsupport@svsubwoofers.com	

Free Manuals Download Website

<http://myh66.com>

<http://usermanuals.us>

<http://www.somanuals.com>

<http://www.4manuals.cc>

<http://www.manual-lib.com>

<http://www.404manual.com>

<http://www.luxmanual.com>

<http://aubethermostatmanual.com>

Golf course search by state

<http://golfingnear.com>

Email search by domain

<http://emailbydomain.com>

Auto manuals search

<http://auto.somanuals.com>

TV manuals search

<http://tv.somanuals.com>