

2005 SUBARU OUTBACK



THE UNION OF POWER, INNOVATION AND PRACTICALITY.

Beware the beaten path. It is the path of followers, not leaders. Of tourists, not explorers. It is the road traveled by those more trusting of convention than invention. And it is not the path of Subaru. Because for over three decades we have blazed our own trail, building the kind of cars people depend on every day. Capable cars. Rational cars. Intelligent cars. We introduced America to the beauty of All-Wheel Drive. We proved ourselves on rally courses around the world, but our journey never truly ends, it merely evolves. As do we, with cars that offer more than mere capability. Much more. They are stylish. Powerful. Exhilarating. They ignite passion. In this way, we constantly push the boundaries. Continually redefining what a Subaru can be.

Is it rational to become emotionally
attached to a car? Or is it only natural?

For example, consider the adventurous
all-new 2005 Subaru Outback. Redesigned,

reengineered and reinvigorated to
deliver world-class levels of performance

and capability, it is far more than a
smarter alternative to the SUV. It is a

driving experience that inspires passion.

AND PASSION.

Devotion. Elation. And a sense of freedom

all its own. All Outback models feature

our innovative horizontally opposed

Subaru Boxer engine with Symmetrical

All-Wheel Drive for unsurpassed

power, safety and handling. A host

of thoughtful amenities. And that

legendary go-anywhere, do-anything

spirit that could only come from Subaru.



OUTBACK 3.0R. THREE DISTINCT MODELS. ONE UNQUENCHABLE THIRST FOR ADVENTURE. INTRODUCING THE ALL-NEW, 250-HP 6-CYLINDER OUTBACK 3.0R



VEHICLES. ENGINEERED TO DELIVER CAR-LIKE PERFORMANCE WITH ALL-WHEEL DRIVE CAPABILITY, THEY INCLUDE THE REFINED L.L.BEAN® EDITION WAGON, THE ADVANCED VDC LIMITED WAGON WITH STABILIZING

VEHICLE DYNAMICS CONTROL (VDC), AND THE REMARKABLY VERSATILE SEDAN.

EACH EQUIPPED WITH AN IRREPRESSIBLE SENSE OF FREEDOM ALL ITS OWN.



17" alloy wheels

SUBARU, 1995

Subaru introduces the Outback—"The World's First Sport Utility Wagon."

Raised suspension

5-speed automatic with
SPORTSHIFT

Roof rails with cross bars

Heated power front seats

ITS DISTINGUISHED PEDIGREE SPEAKS FOR ITSELF. But slip behind the wood and leather-wrapped steering wheel of the all-new Outback 3.0R L.L.Bean® Edition, and you'll discover an amenity-rich interior that says even more. Its numerous refinements include distinctive L.L.Bean-embossed leather-trimmed seats and specially embroidered floor mats. Elegant



1 A panoramic dual-panel moonroof is large enough to turn any drive into an alfresco experience.

2 A generous cargo area with up to 61.7 cubic feet of carrying space offers plenty of room for your gear. And just about all of the L.L.Bean catalog.

3 Distinctive L.L.Bean-embossed leather-trimmed upholstery adds to a seating environment that is as refined as it is ergonomically functional.



titanium metallic trim with woodgrain-patterned accents. Supportive heated power front seats. A convenient dual-zone climate control system with individual climate controls that allow the driver and front passenger to choose their own ideal temperature. And above it all, a large, dual-panel power moonroof that invites stargazing at every stoplight.

Auto-dimming rearview
mirror with compass

Woodgrain-patterned
accents

Steering wheel audio
controls

6-disc CD changer

Under-floor storage tray



SOMETIMES THERE'S SIMPLY NO ESCAPING CIVILIZATION. Or reason to, for that matter. Just consider the remarkably quiet and refined interiors of the Outback 3.0R Sedan and VDC Limited Wagon. Completely redesigned to provide an outstanding driving experience, in both vehicles you'll find elegant, leather-trimmed seats, offering durability with a



1 The Outback 3.0R interiors possess a premium quality that's evident from the moment you enter, starting with a wood and leather-wrapped MOMO brand steering wheel.

2 A luxurious dual-zone automatic climate control system with separate temperature controls allows both driver and front passenger to personalize their specific environments for maximum comfort.

rich, luxurious feel. And within the VDC Limited Wagon, a power dual-panel moonroof that's large enough to bathe the entire cabin in sunlight. Plus an audiophile-pleasing, 7-speaker premium audio system featuring a 6-disc in-dash CD changer with an MP3 player for an unparalleled listening environment. If only your campsite was this well provisioned.

17" alloy wheels

Raised suspension

5-speed automatic with
SPORTSHIFT

Mirrors with integrated
turn signals

Vehicle Dynamics Control
(VDC) system¹



Outback 3.0R VDC Limited Wagon shown with Taupe leather

Leather-trimmed upholstery

Heated power front seats

Premium audio system¹

Dual-zone climate control

Dual-panel power moonroof

¹3.0R VDC Limited only.

OUTBACK 2.5 XT. ADVENTURE SPORTS ARE ONE WAY TO RAISE A HEART RATE. BUT NOT THE ONLY WAY. MEET THE ALL-NEW, ALL-WHEEL DRIVE OUTBACK 2.5 XT AND 2.5 XT LIMITED. POWERED BY A 250-HP INTERCOOLED AND TURBOCHARGED SUBARU BOXER ENGINE, THEIR PULSE-POUNING PERFORMANCE WILL TAKE YOU TO PLACES OTHER VEHICLES JUST CAN'T GO.



17" alloy wheels

Fog lights

Integrated rear spoiler

Reinforced 5-speed manual

SPORTSHIFT manual control¹



Outback 2.5 XT Limited Wagon shown with Charcoal Perforated leather and optional 5-speed automatic transmission



1 Aggressively bolstered performance-design front seats offer firm, comfortable seating yet provide maximized support while maneuvering.

2 A standard 5-speed manual transmission with a dual-mass flywheel clutch offers quick, direct and accurate shifts, for a true performance-oriented feel.

Leather-trimmed upholstery²

Heated front seats

6-disc CD changer

Dual-zone climate control

Dual-panel power moonroof²

¹With optional 5-speed automatic. ²2.5 XT Limited only.



16" alloy wheels

SUBARU, 1974

The Subaru 4WD Wagon is introduced, the first mass-market four-wheel drive passenger car in the United States.

Raised suspension

Heated side mirrors

Roof rails with cross bars

Power driver's seat

OUTBACK 2.5i. SOMETIMES THE ROAD TO ADVENTURE IS PAVED. SOMETIMES IT'S NOT. WHICH IS WHY THE ALL-NEW, ALL-WHEEL DRIVE OUTBACK 2.5i OFFERS A BALANCE OF ON-ROAD PERFORMANCE AND OFF-ROAD CAPABILITY FOR WHEREVER IT LEADS YOU.



1 Well-appointed in every sense, the incredibly functional yet comfortable interior of the Outback 2.5i provides the driver with an array of well-positioned controls within easy reach.

2 Standard 4-stage heated front seats keep both driver and passenger comfortable on the chilliest of mornings.

THE QUEST FOR ADVENTURE doesn't have to be an exercise in deprivation. So the Outback 2.5i and 2.5i Limited boast amenities like a keyless entry system with cargo-area release, and dual 12-volt power outlets. And aboard the even more luxurious 2.5i Limited, you'll find standard leather-trimmed upholstery, and a dual-zone automatic climate control system.

Heated front seats

Leather-trimmed upholstery¹

Trip computer

Security system

Under-floor storage tray

¹ 2.5i Limited only.

WHAT YOU SEE BEFORE YOU is the heart of a Subaru. The innovative, horizontally opposed Subaru Boxer engine. Available in Outback vehicles as a smooth 250-hp 6-cylinder, a potent 250-hp intercooled and turbocharged 4-cylinder, and an energetic 168-hp¹ naturally aspirated 4-cylinder. It is unlike the more conventional engine layouts of other manufacturers in

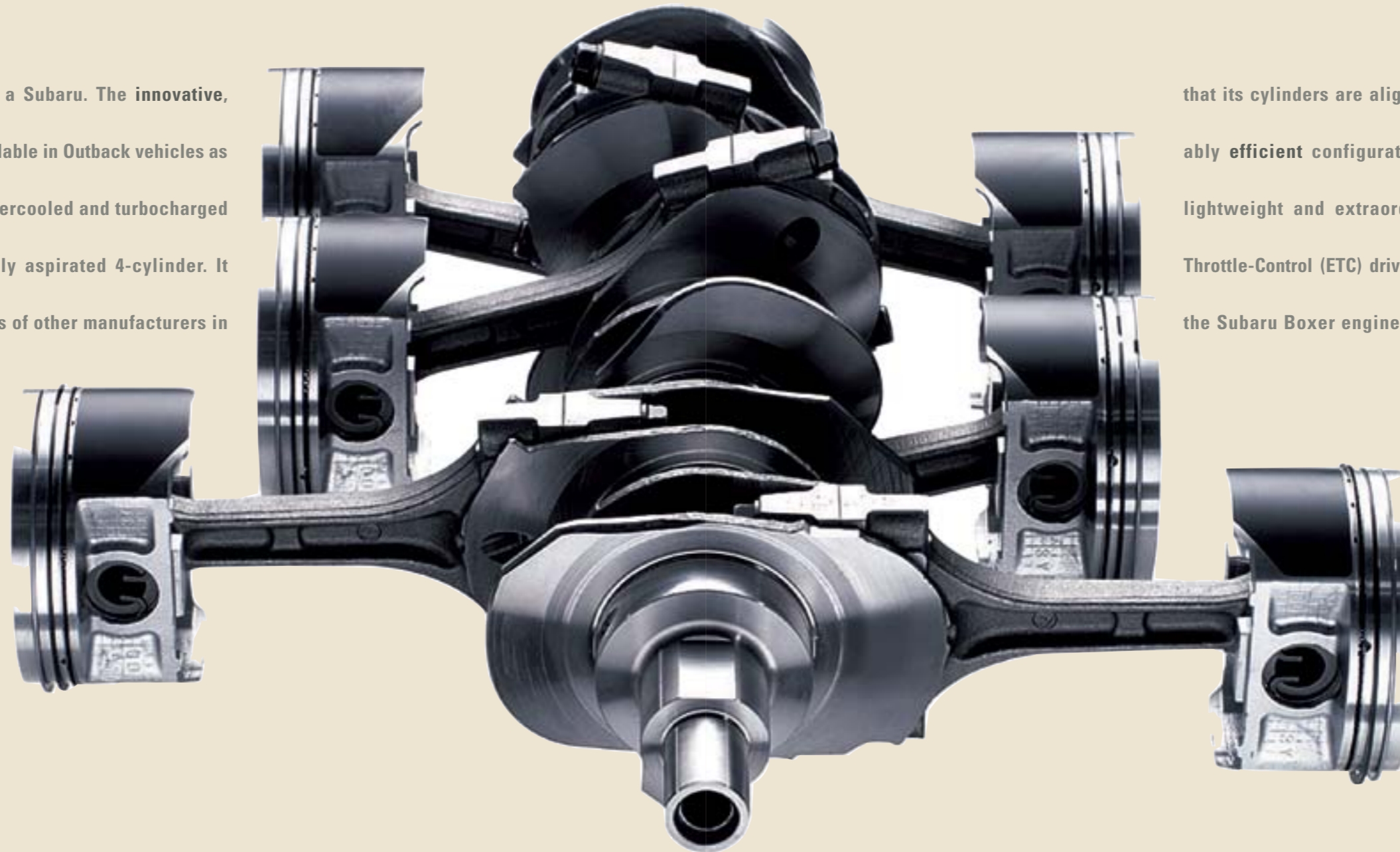

that its cylinders are aligned on a single, horizontal plane. This remarkably efficient configuration results in a powerplant that is compact, lightweight and extraordinarily well-balanced. Now with Electronic Throttle-Control (ETC) drive-by-wire technology for more precise response, the Subaru Boxer engine delivers outstanding power and performance.

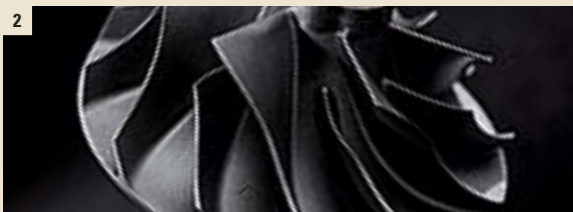

1 Our Active Valve Control System (AVCS) found on Outback 2.5 XT and 3.0R models helps to deliver increased low-end power while allowing for greater breathing at higher engine speeds.

2 Turbocharging the Subaru Boxer engine featured in the Outback 2.5 XT and 2.5 XT Limited allows the benefit of increased horsepower and torque without having to increase engine size or displacement.



3 The Subaru Boxer engine's layout allows it to be placed lower in the chassis, reducing vehicle center-of-gravity for well-balanced handling.

4 Aluminum-alloy block and cylinder heads help to reduce weight, thereby improving overall vehicle balance without sacrificing strength or durability.

Outback Engines	
3.0-liter 6-cylinder	250 hp, 219 lb.-ft. of torque
2.5-liter Turbocharged 4-cylinder	250 hp, 250 lb.-ft. of torque
2.5-liter 4-cylinder	168 hp ¹ , 166 lb.-ft. of torque

ALL-WHEEL DRIVE IS OUR HERITAGE. IT IS OUR PASSION. And it is an integral part of the Subaru experience. Which is why every vehicle we build is equipped with an advanced Symmetrical All-Wheel Drive system. Symmetrical, in that it features drivetrain components

What's more, because every vehicle and driving style has its own specific All-Wheel Drive requirements, Subaru engineers have developed four unique systems, each with their own advantages and capabilities. Integrated with the Subaru Boxer engine and

1 Our 5-speed manual transmission has been reengineered for improved shift feel, and is provided as standard equipment on all Outback 2.5i and 2.5 XT models.



2 Standard on Outback 3.0R models and optional on 2.5 XT models, our new and remarkably smooth-shifting 5-speed automatic transmission with SPORTSHIFT manual control features an adaptive capability that chooses the optimum gear based on driving situations.

3 Most Outback models and All-Wheel Drive system configurations use either a viscous-type or planetary-type center differential, managing torque distribution based on where traction is needed most.



positioned along a longitudinal axis for optimum balance and control. In turn, power is constantly delivered to all four wheels and is automatically distributed where traction is needed most.

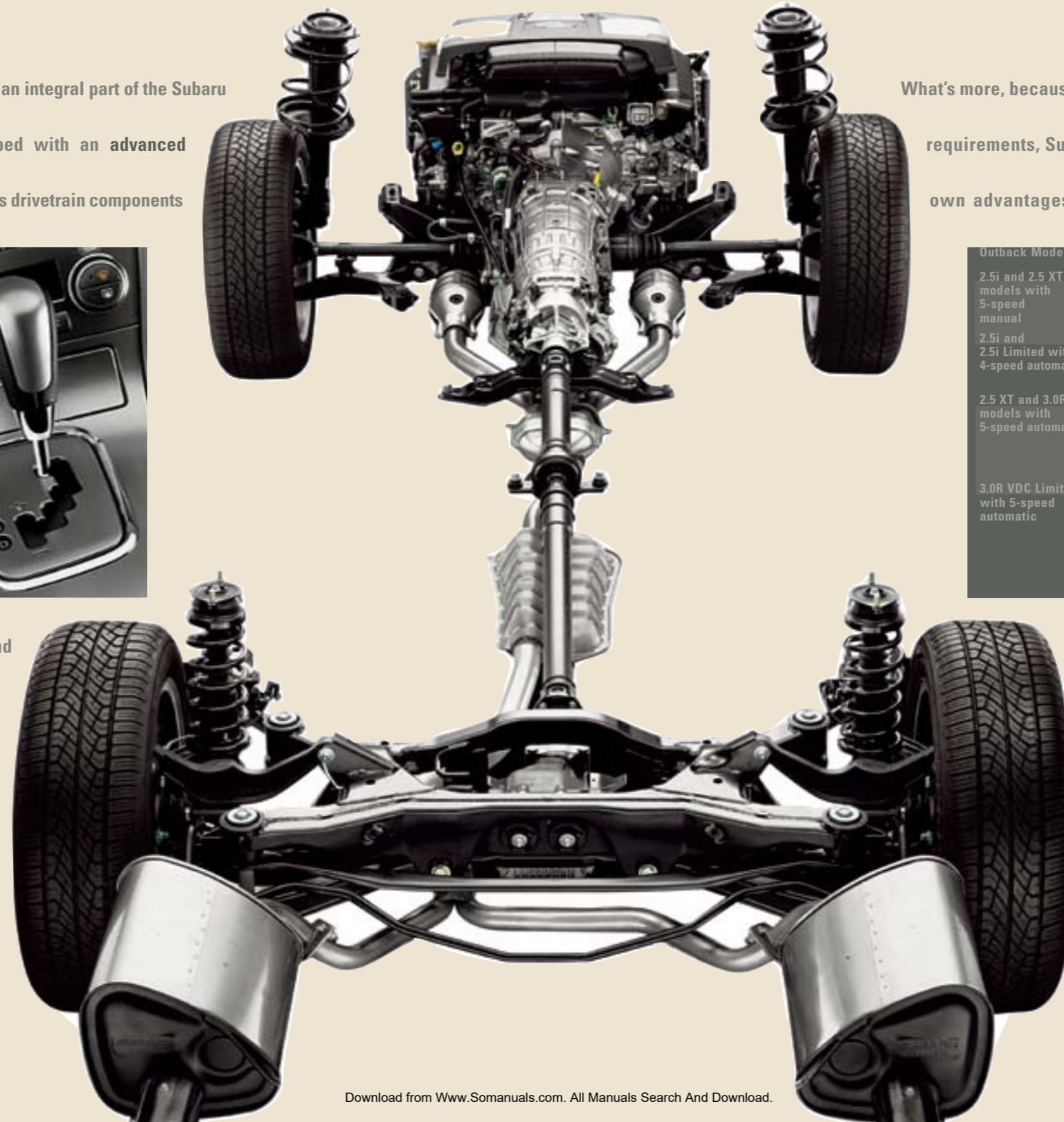

Outback Models	AWD System	How It Works
2.5i and 2.5 XT models with 5-speed manual	Continuous	Utilizing a viscous-center locking differential, under normal conditions power is split 50/50 between the front and rear wheels. If wheel slippage occurs, the center differential helps transfer power to the wheels with the most traction.
2.5i and 2.5i Limited with 4-speed automatic	Active	Featuring an electronically managed continuously variable multi-plate transfer clutch, this AWD system monitors parameters such as wheel slippage and vehicle speed, transferring power to the front or rear wheels with the best traction.
2.5 XT and 3.0R models with 5-speed automatic	VTD	Variable Torque Distribution (VTD) uses an electronically controlled hydraulic transfer clutch in conjunction with a planetary gear-type center differential to control power distribution between the front and rear wheels. Under normal driving conditions, the VTD system splits power 45% front and 55% rear, to deliver more of a performance driving feel.
3.0R VDC Limited with 5-speed automatic	VDC	The most advanced AWD system Subaru has ever offered in the U.S., it combines VTD technology with a stability system called Vehicle Dynamics Control (VDC). Individual sensors placed throughout the vehicle continuously monitor lateral g-forces, yaw, brake pressure, steering angle and wheel speed to detect an unintended deviation in the vehicle's path and help correct it, often before you feel a thing.

complemented by our 4-wheel fully independent suspension, Symmetrical All-Wheel Drive delivers the exceptional performance, agility and handling that makes a Subaru, a Subaru.

THERE IS NO SUBSTITUTE FOR THE OPEN ROAD. BECAUSE IT IS HERE THAT FORM BECOMES FUNCTION. POWER BECOMES PERFORMANCE. AND SUPERLATIVE ENGINEERING IS TRANSFORMED INTO AN ALL-ENCOMPASSING DRIVING EXPERIENCE THAT'S WORTH FAR MORE THAN THE MERE SUM OF ITS PARTS.



BENEATH THE SKIN, the Subaru Boxer engine and Symmetrical AWD integrate seamlessly for extraordinary performance in virtually every environment. They are complemented by precise engine-speed-sensing



1 A heavy-duty raised fully independent suspension provides confident handling on virtually all road conditions.
2 Standard on the Outback 3.0R VDC Limited, Vehicle Dynamics Control (VDC) continuously monitors various vehicle parameters, reacting as necessary to help keep the vehicle on its intended path.

power rack-and-pinion steering, an incredibly rigid yet lightweight body structure and an advanced 4-wheel independent suspension for dynamic, balanced handling.



Symmetrical AWD

SUBARU, 2004

For every model tested, Subaru receives the highest rating in frontal offset crash test results from the Insurance Institute for Highway Safety (IIHS)¹

Seatbelt pre-tensioners and force limiters

Collapsible steering column

Safety brake pedal

Side-impact door beams

THE SUBARU DRIVING EXPERIENCE evokes many emotions. Confidence should always be one of them. Which is why every Subaru is engineered according to the principles of “Active Driving/Active Safety.” Proactive safety components such as full-time Symmetrical AWD and 4-wheel anti-lock disc brakes (ABS) with Electronic Brake-force Distribution (EBD) help provide the

1



2



3



4



1 A newly designed Ring-Shaped Reinforcement Frame helps dissipate crash impact energy away from occupants.

2 An intelligent front air bag system with dual-stage deployment senses driver's seat position and front passenger seat occupancy to determine the safest air bag inflation level for each.

3 Standard side curtain air bags help protect both front and rear outboard passengers from side impacts.

4 Active front seat head restraints help protect against potential whiplash in a collision.

driver with outstanding vehicle control during evasive maneuvering. And when the unexpected becomes the unavoidable, a cocoon of passive safety features, including a Ring-Shaped Reinforcement Frame with enhanced side-impact protection, front and rear crumple zones, side curtain air bags, and more, work in unison to help keep all occupants safe and sound.

Dual-stage front air bags (SRS)²

Side curtain air bags (SRS)²

Front side-impact air bags (SRS)²

Daytime Running Lights (DRL)

LATCH system³

¹ For more information, contact the Insurance Institute for Highway Safety or visit their Web site at www.iihs.org.

² Always wear seatbelts. Children should be properly restrained in appropriate child or booster seats. Always use proper tie-down technique. Always use proper tie-down technique.

BECAUSE EVERYONE'S IDEA of a perfect driving experience is unique, a wide variety of Genuine Subaru Accessories is available to make your Outback as distinctive as you are. Crafted with the same quality, durability, fit and finish as the vehicle itself, these specially designed accessories offer a means to accentuate every aspect of your Outback with



1 Heavy-duty Roof Cargo Basket with Fork-mounted Bike Carrier and Front-wheel Holder: Carries up to 100 lbs. of cargo, and includes mounting hardware, black cargo net with hooks and custom fairing. Shown with accessory Fork-mounted Bike Carrier and Front-wheel Holder (sold separately).

2 Roof-mounted Bicycle Attachment: Securely transports one bicycle and accommodates 1" to 3" downtubes.

3 Round Cross Bar Set: May be used in conjunction with all genuine Subaru roof attachments and carriers. Stabilizing brackets sold separately.

4 Roof Cargo Carrier: Provides 11 cubic feet and up to 100 lbs. of lockable storage capacity.

5 Hitch-mounted Bicycle Attachment: Slides into trailer hitch to carry up to 2 bikes. Designed for easy dismantling of bikes without lifting!

6 Kayak Carrier: Attaches quickly and easily to cross bars. Carries two kayaks.

7 Front Bumper Guard: Finishes off and helps protect lower front bumper from brush and debris.

8 Hood Protector: Acrylic plastic and wrap-around design help protect hood from stone chips and bugs

Compartment separator/
dog guard

Cargo net (rear)

Air filtration system

Rear differential
protector

Security system
perimeter alarm

personalized style, functionality and luxury. Moreover, all Genuine Subaru Accessories are backed by your basic vehicle 3-year/36,000-mile warranty when installed at the time of vehicle purchase. For complete warranty details, or to learn more about the full range of available Outback accessories, see your Subaru dealer or visit www.subaru.com.

<p>1 Moonroof Air Deflector: Helps reduce wind noise and cut sun glare.</p> <p>2 Rear Spoiler (Sedan): Color-matched rear deck spoiler with integrated brake light.</p> <p>3 MOMO Shift Knob (Automatic): Satin-machined aluminum shift knob with perforated leather accents lends a stylish look of performance to the 2.5 XT and 3.0R models.</p> <p>4 Cargo Nets: Rear of Back Seat (1) and Sides (2): Cargo net storage helps keep wagon cargo area organized.</p> <p>5 Auto-dimming Mirror Compass: Includes electronic compass. Mirror darkens when headlights are detected from rear of vehicle.</p> <p>6 Center Armrest Extension: Raises up and forward for additional comfort when driving.</p> <p>7 Sub-woofer Amplifier: Delivers rich, deep bass you not only hear but feel.</p> <p>8 All-weather Mats: Custom-fitted, heavy-gauge protective mats.</p> <p>9 Cooler/Warmer: Keeps food and beverages either cool or warm. Plugs into power outlet in cargo area of Outback wagon.</p> <p>10 Trailer Hitch: Heavy-duty rated at 200 lbs. tongue weight; 2,700 lbs. (4-cyl.), 3,000 lbs. (6-cyl.) towing capacity.²</p> <p>11 Wheel Locks: Help to protect your investment in alloy wheels and tires.</p>				
				
				

Engine-block heater

Battery warmer

Car cover (sedan
and wagon)

Front-end cover
(full and hood)

Cargo-area spotlight

²Trailer brakes may be needed. Ball not included.



2005 SUBARU WARRANTIES, CUSTOMER SERVICE AND SUPPORT

Basic Warranty: 3 years or 36,000 miles, whichever comes first.

Powertrain Warranty: 5 years or 60,000 miles, whichever comes first.

Rust Perforation Warranty: 5 years, unlimited mileage.

Subaru Added Security® could be the most important option you choose. Protect your investment with a Subaru Added Security extended service contract—the only one backed by Subaru of America, Inc. Ask your salesperson for coverage details and assistance in selecting the plan that's best for you, up to 7 years or 100,000 miles.

The Subaru Roadside Assistance Program covers all 2005 Subaru vehicles during the first three years or 36,000 miles, whichever comes first. By calling the toll-free number in the Owner's Information Kit, Subaru owners can take advantage of any of the following benefits:

- **24-hour Roadside Assistance, seven days a week, 365 days a year, throughout the United States.**
- **Emergency Towing Service to the nearest authorized Subaru dealer.**
- **Emergency Roadside Assistance, for jump starts, gasoline (up to two gallons), flat tire change, emergency lockout service (lost key or key is locked in the vehicle) and emergency fluid replacement.**

See your Subaru dealer for details.

For complete warranty information, including coverage and exclusions, see your Subaru dealer.

SUBARU.COM YOU CAN BEGIN YOUR SUBARU EXPERIENCE RIGHT NOW, IN YOUR VERY OWN LIVING ROOM. GO TO SUBARU.COM, WHERE YOU'LL DISCOVER AN ONLINE ENVIRONMENT RICH WITH IN-DEPTH INFORMATION, REVIEWS, SPECIFICATIONS AND PHOTOGRAPHS ENCOMPASSING THE FULL LINE OF SUBARU VEHICLES. HERE YOU CAN TAKE A 360° TOUR OF ANY MODEL, BUILD YOUR OWN SUBARU, LOCATE VEHICLES, EVEN SCHEDULE A TEST DRIVE. AND AT MY.SUBARU.COM, SUBARU OWNERS CAN ACCESS THEIR VEHICLE'S SERVICE AND WARRANTY HISTORY, SCHEDULE APPOINTMENTS AND MUCH MORE. IT'S ALL QUICK, EASY AND JUST A MOUSE-CLICK AWAY.



PAINT COLORS



Atlantic Blue Pearl



Brilliant Silver Metallic



Champagne Gold Opal



Garnet Red Pearl



Obsidian Black Pearl



Satin White Pearl



Atlantic Blue Pearl/
Granite Gray Opal



Brilliant Silver Metallic/
Granite Gray Opal



Champagne Gold Opal/
Granite Gray Opal



Satin White Pearl/
Granite Gray Opal



Willow Green Opal/
Moss Green Metallic

UPHOLSTERY



Charcoal Flat Woven Cloth



Taupe Flat Woven Cloth

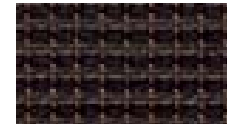

Tweed Flat Woven Cloth



Charcoal Leather



Charcoal Perforated
Leather

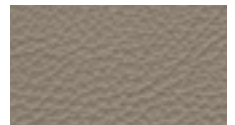

Taupe Leather

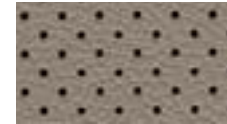

Taupe Perforated Leather

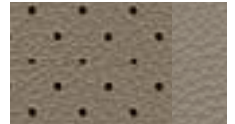

Dark Taupe Perforated/
Taupe Leather

COLOR COMBINATIONS

Outback Models		Atlantic Blue Pearl	Brilliant Silver Metallic	Champagne Gold Opal	Garnet Red Pearl	Obsidian Black Pearl	Satin White Pearl	Atlantic Blue Pearl/ Granite Gray Opal	Brilliant Silver Metallic/ Granite Gray Opal	Champagne Gold Opal/ Granite Gray Opal	Satin White Pearl/ Granite Gray Opal	Willow Green Opal/ Moss Green Metallic
2.5i Wagon	Charcoal Flat Woven Cloth ¹	—	—	—	—	■	—	■	■	—	—	—
	Taupe Flat Woven Cloth ²	—	—	■	—	—	—	—	—	■	■	■
2.5i Limited Wagon	Charcoal Leather ¹	—	—	—	—	■	—	—	—	—	—	—
	Taupe Leather ²	—	—	■	—	—	—	—	—	■	■	■
2.5 XT Wagon	Tweed Flat Woven Cloth ¹	—	—	■	■	■	—	■	■	—	■	—
2.5 XT Limited Wagon	Charcoal Perforated Leather ¹	—	—	■	■	■	—	■	■	—	■	—
	Taupe Perforated Leather ²	—	—	■	■	■	—	—	—	—	■	—
3.0R Sedan	Taupe Leather ²	■	■	■	■	■	■	—	—	—	—	—
3.0R VDC Limited Wagon	Taupe Leather ²	—	—	■	■	■	—	■	■	—	■	—
3.0R L.L.Bean Edition Wagon	Dark Taupe Perforated/ Taupe Leather ²	—	—	■	—	■	—	■	■	■	■	■

■ Standard — Not Available

¹Titanium Metallic interior trim.

²Titanium Metallic interior trim with woodgrain-patterned accents.

SPECIFICATIONS

	Outback 2.5i Wagon	Outback 2.5i Limited Wagon	Outback 2.5 XT Wagon	Outback 2.5 XT Limited Wagon	Outback 3.0R VDC Limited Wagon	Outback 3.0R L.L.Bean® Edition Wagon	Outback 3.0R Sedan
ENGINE AND DRIVETRAIN							
Engine	2.5-liter SOHC aluminum-alloy 16-valve horizontally opposed 4-cylinder Subaru Boxer engine. Platinum-tipped spark plugs.		2.5-liter DOHC intercooled, turbocharged aluminum-alloy 16-valve 4-cylinder horizontally opposed Subaru Boxer engine with Active Valve Control System (AVCS). Iridium spark plugs.		3.0-liter DOHC aluminum-alloy 24-valve 6-cylinder horizontally opposed Subaru Boxer engine with Active Valve Control System (AVCS) and Active Valve Lift System (AVLS). Iridium spark plugs.		
Power	168 hp @ 5,600 rpm ¹		250 hp @ 6,000 rpm		250 hp @ 6,600 rpm		
Torque	166 lb.-ft. @ 4,000 rpm		250 lb.-ft. @ 3,600 rpm		219 lb.-ft. @ 4,200 rpm		
Compression ratio	10.0:1		8.2:1		10.7:1		
Bore and stroke	99.5 x 79 mm		99.5 x 79 mm		89.2 x 80 mm		
Intake system	Aluminum-alloy intake manifold.		Composite-resin intake manifold. Crossflow turbocharger with air-to-air intercooler. Maximum boost pressure: 13.5 psi.		Composite-resin intake manifold.		
Fuel and ignition system	Sequential multi-port fuel injection. Electronic Throttle Control (ETC). Engine management with integrated self-diagnostics and adaptive driving habits capability. Distributorless electronic ignition – 2.5i models. Direct ignition – 2.5 XT and 3.0R models.						
Manual transmission	Standard fully synchronized 5-speed manual with clutch pedal-controlled starter interlock.		Standard fully synchronized reinforced 5-speed manual with dual-mass flywheel and clutch pedal-controlled starter interlock.		Not available.		
Automatic transmission	Optional 4-speed adaptive electronic direct-control automatic with SPORTSHIFT manual control.		Optional 5-speed adaptive electronic direct-control automatic with SPORTSHIFT manual control. Steering wheel-mounted SPORTSHIFT buttons.		Standard 5-speed adaptive electronic direct-control automatic with SPORTSHIFT manual control.		
Fuel economy (city/highway)	Manual: 23/28 mpg, Automatic: 22/28		Manual: 19/25 mpg, Automatic: 19/24 mpg		Automatic: 19/25 mpg		

SYMMETRICAL ALL-WHEEL DRIVE

Continuous All-Wheel Drive	Models equipped with 5-speed manual transmission utilize a viscous-type locking center differential with torque distribution configured at a 50/50-split front-to-rear. Also included is a limited-slip rear differential.
Active All-Wheel Drive	Models equipped with 4-speed automatic transmission utilize an electronically controlled variable transfer clutch to distribute power to where traction is needed. Sensors monitor parameters such as wheel slippage, throttle position and braking to help determine torque distribution to the wheels with optimum traction. Also included is a limited-slip rear differential.
Variable Torque Distribution (VTD) All-Wheel Drive	Models equipped with 5-speed automatic transmission utilize an electronically controlled variable transfer clutch in conjunction with a planetary-type center differential. Rear wheel-biased torque distribution normally configured at 45/55-split front-to-rear. Also included is a limited-slip rear differential.
Vehicle Dynamics Control (VDC) All-Wheel Drive	Exclusive to the Outback 3.0R VDC Limited Wagon, this system combines VTD All-Wheel Drive with VDC stability control. Sensors constantly monitor wheel speed, steering angle, brake pressure, vehicle's yaw rate and lateral g-forces. If VDC detects a difference between driver's intended path of travel and path vehicle is actually taking, VDC applies braking power and/or reduces engine torque to help correct vehicle path. Also included is a limited-slip rear differential.

CHASSIS

Steering	Engine-speed-sensing power-assisted rack-and-pinion. Turns lock-to-lock: 3.2. Turning circle: 35.4 ft.		
Suspension	4-wheel independent heavy-duty raised suspension. Front: Strut-type with lower L-arm. Antidive geometry. Rear: Multi-link with antilift and antisquat geometry. Front and rear stabilizer bars.		
Brakes	4-wheel disc, ventilated front.	4-wheel disc, ventilated front.	4-wheel disc, ventilated front.
	4-channel, 4-sensor ABS with Electronic Brake-force Distribution (EBD).		
Brake discs (in.)	11.5 front/10.6 rear	11.5 front/10.6 rear	11.5 front/10.6 rear

WHEELS AND TIRES

Wheels	16 x 6.5-inch 6-spoke aluminum-alloy. Silver finish.	17 x 7.0-inch 5-spoke aluminum-alloy. Silver finish (Gray finish on 3.0R L.L.Bean Edition).
Tires	225/60 R16 97H performance all-season	225/55 R17 95V high-performance all-season

DIMENSIONS

	Wagons						Sedan
Length	188.7 in.						186.2 in.
Height	63.2 in. (includes roof rails and cross bars)						59.1 in.
Width	69.7 in.						69.7 in.
Wheelbase	105.1 in.						105.1 in.
Track (front/rear)	58.9 in./58.7 in.						58.9 in./58.7 in.
Curb weight (manual/automatic)	2.5i Wagon: 3,310 lbs./3,355 lbs.	2.5i Limited Wagon: 3,365 lbs./3,410 lbs.	2.5 XT Wagon: 3,415 lbs./3,480 lbs.	2.5 XT Limited Wagon: 3,500 lbs./3,565 lbs.	3.0R VDC Limited Wagon: N/A/3,630 lbs.	3.0R L.L.Bean Edition Wagon: N/A/3,600 lbs.	3.0R Sedan: N/A/3,545 lbs.
Coefficient of drag (cd)	0.31						0.29
Ground clearance	8.4 in. (2.5 XT models: 8.7 in.)						8.4 in.
Angle of approach	18.7° (2.5 XT and 3.0R models: 18.3°)						18.3°
Breakover angle	19.7°						19.7°
Angle of departure	22.0°						20.0°
Towing capacity (Class I)	2,700 lbs. (3.0R models: 3,000 lbs.)						3,000 lbs.
Headroom (front/rear) with moonroof	38.7 in./37.1 in. (2.5i and 2.5 XT models without moonroof: 40.5 in./39.1 in.)						37.5 in./36.5 in.
Legroom (front/rear)	44.1 in./33.9 in.						44.1 in./33.9 in.
Shoulder room (front/rear)	54.4 in./53.7 in.						54.4 in./53.7 in.
Cabin capacity	97.4 cu. ft.						93.1 cu. ft.
Cargo capacity with moonroof	32.1 cu. ft./61.7 cu. ft. with rear seat lowered (2.5i and 2.5 XT models without moonroof: 33.5 in./66.2 in. with rear seat lowered)						11.4 cu. ft.

EQUIPMENT

EXTERIOR

	Outback 2.5i Wagon	Outback 2.5i Limited Wagon	Outback 2.5 XT Wagon	Outback 3.0R Limited Wagon	Outback 3.0R VDC Limited Wagon	Outback 3.0R L.L.Bean Edition Wagon
Projector beam low-beam and multi-reflector high-beam headlights and fog lights	■	■	■	■	■	■
Aluminum-alloy hood with raised strakes	■	■	—	—	■	■
Aluminum-alloy hood with functional scoop (feeds turbocharger intercooler)	—	—	■	■	—	—
Front bumper with lower air intake and integrated front spoiler	■	■	■	■	■	■
Front bumper with lower air intake, integrated front spoiler and underguard	—	—	—	—	■	■
Black door handles and side mirrors	■	—	—	—	—	—
Body-color door handles and side mirrors	—	■	■	■	■	■
Body-color side mirrors with integrated turn signals	—	—	■	■	■	■
Heated side mirrors and windshield wipers de-icer	■	■	■	■	■	■
Two-speed windshield wipers with variable intermittent mode	■	■	■	■	■	■
Single-speed rear window wiper with fixed intermittent mode and de-icer; when front wipers are on, selecting reverse gear (with automatic transmission) activates rear wiper	■	■	■	■	—	■
Lower-body cladding with enlarged front and rear fenders	■	■	■	■	■	■
Splash guards (black or body color, depending on exterior color)	■	■	■	■	—	■
Aluminum-alloy tailgate with integrated rear spoiler	■	■	■	■	—	■
Black-finish raised roof rails with cross bars (100 lbs. capacity)	■	■	■	■	—	■
Power tilt/sliding glass moonroof	—	—	—	—	■	—
Panoramic tilt/sliding dual-panel moonroof	—	■	—	■	—	■

SEATING AND TRIM

8-way power driver's seat with manually adjustable lumbar support; 4-way manually adjustable front passenger seat	■	■	■	—	—	—
8-way power driver's seat and 4-way power front passenger seat, both with manually adjustable lumbar support	—	—	—	■	■	■
4-stage heated front seats	■	■	■	■	■	■
Performance-design front seats	—	—	■	■	—	—
Rear-center armrest (with trunk pass-through on 3.0R Sedan)	—	—	■	■	■	■
60/40-split flat-folding rear seatback	■	■	■	■	—	■
3-spoke steering wheel with manually adjustable tilt column	■	—	—	—	—	—
Perforated leather-wrapped 3-spoke steering wheel with manually adjustable tilt column	—	■	—	—	—	—
Perforated leather-wrapped 3-spoke MOMO brand steering wheel with manually adjustable tilt column	—	—	■	■	—	—
Wood and leather-wrapped 3-spoke MOMO brand steering wheel with manually adjustable tilt column	—	—	—	—	■	■
Perforated leather-wrapped shifter handle	—	■	■	■	■	■
Cloth upholstery	■	—	■	—	—	—
Leather-trimmed upholstery	—	■	—	—	■	■
Perforated leather-trimmed upholstery	—	—	—	■	—	—
L.L.Bean®-embossed two-tone perforated leather-trimmed upholstery	—	—	—	—	—	■
Titanium metallic trim on doors, console and automatic shifter handle ²	■	■	■	■	—	—
Titanium metallic trim with woodgrain-patterned accents on doors, console and automatic shifter handle ³	■	■	—	■	■	■
Carpeted floor mats	■	■	■	■	■	■

CONVENIENCE FEATURES

Power front and rear windows with driver's auto-down	■	■	■	■	■	■
Electronically controlled cruise control	■	■	■	■	■	■
Dual cup holders in center console with retractable lid; retractable dual rear cup holders	■	■	■	■	■	■
Sun visors with extenders and illuminated vanity mirrors	■	■	■	■	■	■
Overhead console with dual maplights and sunglasses storage	■	—	■	—	—	—
Auto-dimming rearview mirror with compass	□ ¹	□ ¹	□ ¹	□ ¹	□ ¹	■
Illuminated glove box and in-dash storage compartment	■	■	■	■	■	■
Center console with armrest and enclosed storage compartment	■	■	■	■	■	■
12-volt power outlets in center console storage compartment and wagons' cargo area	■	■	■	■	■	■
Trunk/cargo-area concealed under-floor storage tray; concealed storage compartments in cargo-area side panels; dual grocery bag hooks	■	■	■	■	■	■
Retractable/removable cargo-area cover; removable cargo-area tray; 4 tie-down hooks	■	■	■	■	—	■

■ Standard □ Optional — Not available

Outback 3.0R L.L.Bean Edition Wagon
 Outback 3.0R VDC Limited Wagon
 Outback 3.0R Limited Wagon
 Outback 2.5 XT Limited Wagon
 Outback 2.5i Limited Wagon
 Outback 2.5i Wagon

INSTRUMENTATION

Analog speedometer, tachometer, coolant temperature and fuel gauges with illuminated red needles on black faces and white indicators	■	■	■	■	■	■	■
Sport-design electroluminescent lighting	—	—	■	■	—	—	—
Gauge needles full sweep on start up	■	■	■	■	■	■	■
Digital odometer and automatic transmission (when equipped) shift-position indicator	■	■	■	■	■	■	■
Digital trip computer displaying fuel economy, driving range, digital clock and ambient temperature	■	■	■	■	■	■	■

AUDIO SYSTEMS

6-speaker audio system with single-disc in-dash CD player	■	—	—	—	—	—	—
6-speaker audio system with 6-disc in-dash CD player	—	■	■	■	■	—	■
7-speaker premium audio system with subwoofer and 6-disc in-dash CD player and MP3 player	—	—	—	—	—	■	—
Steering wheel-mounted audio controls	—	—	—	—	■	■	■

CLIMATE CONTROL

Manually adjustable CFC-free air conditioning system with rotary controls for temperature, 4-speed fan and airflow direction	■	—	—	—	—	—	—
Dual-zone automatic digital climate control system with controls for temperature, 6-speed fan, airflow direction, automatic mode and CFC-free air conditioning	—	■	■	■	■	■	■

SECURITY

Keyless entry system with trunk release (sedan) or cargo-area unlock (wagons) and answer-back electronic chirp	■	■	■	■	■	■	■
Antitheft security system with answer-back electronic chirp	■	■	—	—	—	—	—
Antitheft security system with engine immobilizer and answer-back electronic chirp	—	—	■	■	■	■	■

SAFETY

Dual-stage deployment driver and front passenger front air bags (SRS) ⁵	■	■	■	■	■	■	■
Intelligent air bag system with driver's seat position sensor and front passenger seat occupant detection sensor (SRS) ⁵	■	■	■	■	■	■	■
Side curtain air bags protecting front and rear outboard occupants (SRS) ⁵	■	■	■	■	■	■	■
Seat-mounted front side-impact air bags (SRS) ⁵	■	■	■	■	■	■	■
Height-adjustable active front seat head restraints help reduce the potential for whiplash in certain collisions	■	■	■	■	■	■	■
Three individual height-adjustable rear head restraints (height-adjustable outboard rear head restraints on sedan)	■	■	■	■	■	■	■
Height-adjustable 3-point front seatbelts with pre-tensioners and force limiters; 3-point rear seatbelts at all seating positions	■	■	■	■	■	■	■
Rear child safety door locks	■	■	■	■	■	■	■
LATCH system: Lower Anchors and Tethers for CHildren.	■	■	■	■	■	■	■
Safety brake pedal system	■	■	■	■	■	■	■
Energy-absorbing collapsible steering column	■	■	■	■	■	■	■
Ring-Shaped Reinforcement Frame body structure with hydroformed center-pillar construction for increased side-impact protection	■	■	■	■	■	■	■
Daytime Running Lights (DRL)	■	■	■	■	■	■	■
Tire Pressure Monitoring System (TPMS)	—	—	—	—	■	■	■

■ Standard □ Optional — Not available

¹Some 2005 Outback models with the naturally aspirated 2.5-liter engine distributed for sale in California (and in Maine, Massachusetts, New York and Vermont which have adopted California Specification Emission Control Systems and Warranties and are registered for use in those states) will be specially equipped to meet the California Partial Zero Emission Vehicle (PZEV) credited Super-Ultra Low Emission Vehicle (SULEV2) requirements. Horsepower for these models is rated at 163 hp @ 5,600 rpm. The manufacturer's PZEV emission control system warranty coverage is for 15 years or 150,000 miles, whichever comes first. For complete warranty information, including coverage and exclusions, see your Subaru dealer.

²Standard interior trim with Charcoal Flat Woven cloth, Tweed Flat Woven cloth and Charcoal leather upholstery. See color combinations chart.

³Standard interior trim with Taupe Flat Woven cloth and Taupe leather upholstery. See color combinations chart.

⁴Available as an accessory. See your dealer.

⁵The Supplemental Restraint System (SRS) (air bags) affords the driver and the front and rear outboard passengers additional protection in moderate to severe frontal and side-impact collisions. This system provides supplemental protection only, and seatbelts must be worn in order to avoid injuries to out-of-position occupants upon bag deployment and to provide the best combined protection in a serious accident. Children should always be properly restrained in the rear seat.

Some images shown are for illustration purposes only. Specifications in this brochure are based on the latest product information available at the time of publication. Some equipment shown in photography in this brochure is optional at extra cost. Specific options may be available only in combination with other options. Specific combinations of equipment or features may vary from time to time and by geographic area. Certain accessories and equipment may not be available at the time of publication. Subaru of America, Inc., reserves the right to change or discontinue at any time, without notice, prices, colors, materials, equipment, accessories, specifications, models and packages without incurring any obligation to make the same or similar changes on vehicles previously sold. Colors shown may vary due to reproduction and printing processes. This brochure was prepared by Subaru of America, Inc. A warranty from Subaru of America, Inc., is available only on cars sold to the first retail purchaser through an authorized Subaru dealer in the continental U.S. or Alaska. Subaru, Subaru Boxer, Outback, SPORTSHIFT, L.L.Bean and MOMO are registered trademarks. For more information, contact your Subaru dealer or log on to www.subaru.com.



SUBARU[®]
DRIVEN BY WHAT'S INSIDE.[™]

Free Manuals Download Website

<http://myh66.com>

<http://usermanuals.us>

<http://www.somanuals.com>

<http://www.4manuals.cc>

<http://www.manual-lib.com>

<http://www.404manual.com>

<http://www.luxmanual.com>

<http://aubethermostatmanual.com>

Golf course search by state

<http://golfingnear.com>

Email search by domain

<http://emailbydomain.com>

Auto manuals search

<http://auto.somanuals.com>

TV manuals search

<http://tv.somanuals.com>