



MODEL

EH72D

INSTRUCTIONS FOR USE

FOR EMISSION CERTIFIED ENGINE

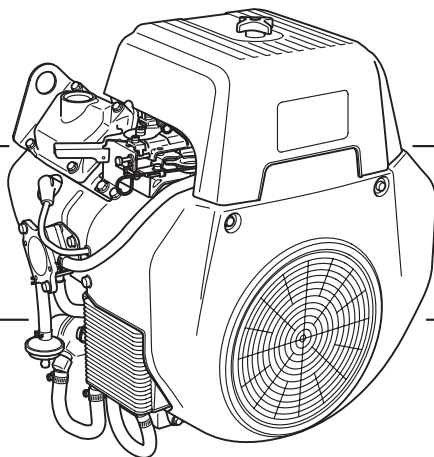

ISSUE EMD-EU1725

2ZZ9020085

Robin Engines



WARNING :



The engine exhaust from this product contains chemicals known to the State of California to cause cancer, birth defects or other reproductive harm.

NOTICE

FEDERAL EMISSION COMPONENT DEFECT WARRANTY and CALIFORNIA EMISSION CONTROL WARRANTY are applicable to only those engines complied with EPA (Environmental Protection Agency) and CARB (California Air Resources Board) emission regulations in the U.S.A.

NOTICE

To the engines exported to and used in the countries other than the U.S.A., warranty service shall be performed by the distributor in each country in accordance with the standard Robin engine warranty policy as applicable.

AIR INDEX

To show compliance with California emission regulations, a hangtag has been provided displaying the Air Index level and durability period of this engine.

The Air Index level defines how clean an engine's exhaust is over a period of time. A bar graph scaled from "0" (most clean) to "10" (least clean) is used to show an engine's Air Index level. A lower Air Index level represents cleaner exhaust from an engine.

The period of time (in hours) that the Air Index level is measured is known as the durability period. Depending on the size of the engine, a selection of time periods can be used to measure the Air Index level (see below).

<u>Descriptive Term</u>	<u>Applicable to Emissions</u>	<u>Durability Period</u>
Moderate	-	50 hours (engine from 0 to 65 cc)
		125 hours (engine greater than 65 cc)
Intermediate	-	125 hours (engine from 0 to 65 cc)
		250 hours (engine greater than 65 cc)
Extended	-	300 hours (engine from 0 to 65 cc)
		500 hours (engine greater than 65 cc)

Notice : This hangtag must remain on this engine or piece of equipment, and only be removed by the ultimate purchaser before operation.

FEDERAL EMISSIONS COMPONENT DEFECT WARRANTY

EMISSIONS COMPONENT DEFECT WARRANTY COVERAGE - This emission warranty is applicable in all States, except the State of California

Fuji Heavy Industries Ltd. and Robin America Inc., Wood Dale Illinois, (herein "ROBIN AMERICA") warrant(s) to the initial retail purchaser and each subsequent owner, that this Nonroad engine (herein "engine") has been designed, built, and equipped to conform at the time of initial sale to all applicable regulations of the U.S. Environmental Protection Agency (EPA), and that the engine is free of defects in materials and workmanship which would cause this engine to fail to conform with EPA regulations during its warranty period.

For the components listed under PARTS COVERED, the service dealer authorized by ROBIN AMERICA will, at no cost to you, make the necessary diagnosis, repair, or replacement necessary to ensure that the engine complies with applicable U.S. EPA regulations.

EMISSION COMPONENT DEFECT WARRANTY PERIOD

The warranty period for this engine begins on the date of sale to the initial purchaser and continues for a period of 2 years.

PARTS COVERED

Listed below are the parts covered by the Emission Components Defect Warranty. Some of the parts listed below may require scheduled maintenance and are warranted up to the first scheduled replacement point for that part.

- | | |
|---|--|
| (1) Fuel Metering System | (3) Ignition System |
| (i) Carburetor and internal parts (and/or pressure regulator or fuel injection system). | (i) Spark plugs. |
| (ii) Air/fuel ratio feedback and control system, if applicable. | (ii) Magneto or electronic ignition system. |
| (iii) Cold start enrichment system, if applicable. | (iii) Spark advance/retard system, if applicable. |
| (iv) Regulator assy (gaseous fuel, if applicable) | (4) Exhaust manifold, if applicable |
| (2) Air Induction System | (5) Miscellaneous Items Used in Above Systems |
| (i) Intake manifold, if applicable | (i) Electronic controls, if applicable |
| (ii) Air filter. | (ii) Hoses, belts, connectors, and assemblies. |
| | (iii) Filter lock assy (gaseous fuel, if applicable) |

OBTAINING WARRANTY SERVICE

To obtain warranty service, take your engine to the nearest authorized Robin America service dealer. Bring your sales receipts indicating date of purchase for this engine. The service dealer authorized by ROBIN AMERICA will perform the necessary repairs or adjustments within a reasonable amount of time and furnish you with a copy of the repair order. All parts and accessories replaced under this warranty become the property of ROBIN AMERICA.

WHAT IS NOT COVERED

*Conditions resulting from tampering, misuse, improper adjustment (unless they were made by the service dealer authorized by ROBIN AMERICA during a warranty repair), alteration, accident, failure to use the recommended fuel and oil, or not performing required maintenance services.

- *The replacement parts used for required maintenance services.
- *Consequential damages such as loss of time, inconvenience, loss of use of the engine or equipment, etc.
- *Diagnosis and inspection charges that do not result in warranty-eligible service being performed.
- *Any non-authorized replacement part, or malfunction of authorized parts due to use of non-authorized parts.

OWNER'S WARRANTY RESPONSIBILITIES

As the engine owner, you are responsible for the performance of the required maintenance listed in your owner's manual. ROBIN AMERICA recommends that you retain all receipts covering maintenance on your engine, but ROBIN AMERICA cannot deny warranty solely for the lack of receipts or for your failure to ensure the performance of all scheduled maintenance.

As the engine owner, you should however be aware that ROBIN AMERICA may deny warranty coverage if your engine or a part has failed due to abuse, neglect, improper maintenance or unapproved modifications.

You are responsible for presenting your engine to the nearest service dealer authorized by ROBIN AMERICA when a problem exists.

If you have any questions regarding your warranty rights and responsibilities, you should contact the Robin America customer service department at 1-630-350-8200 for the information.

THINGS YOU SHOULD KNOW ABOUT THE EMISSION CONTROL SYSTEM WARRANTY MAINTENANCE AND REPAIRS

You are responsible for the proper maintenance of the engine. You should keep all receipts and maintenance records covering the performance of regular maintenance in the event questions arise. These receipts and maintenance records should be transferred to each subsequent owner of the engine. ROBIN AMERICA reserves the right to deny warranty coverage if the engine has not been properly maintained. Warranty claims will not be denied, however, solely because of the lack of required maintenance or failure to keep maintenance records.

MAINTENANCE, REPLACEMENT OR REPAIR OF EMISSION CONTROL DEVICES AND SYSTEMS MAY BE PERFORMED BY ANY REPAIR ESTABLISHMENT OR INDIVIDUAL ; HOWEVER, WARRANTY REPAIRS MUST BE PERFORMED BY A SERVICE DEALER AUTHORIZED BY ROBIN AMERICA. THE USE OF PARTS THAT ARE NOT EQUIVALENT IN PERFORMANCE AND DURABILITY TO AUTHORIZED PARTS MAY IMPAIR THE EFFECTIVENESS OF THE EMISSION CONTROL SYSTEM AND MAY HAVE A BEARING ON THE OUTCOME OF A WARRANTY CLAIM.

If other than the parts authorized by ROBIN AMERICA are used for maintenance replacements or for the repair of components affecting emission control, you should assure yourself that such parts are warranted by their manufacturer to be equivalent to the parts authorized by ROBIN AMERICA in their performance and durability.

HOW TO MAKE A CLAIM

All repair qualifying under this limited warranty must be performed by a service dealer authorized by ROBIN AMERICA. In the event that any emission-related part is found to be defective during the warranty period, you shall notify Robin America customer service department at 1-630-350-8200 and you will be advised of the appropriate warranty service dealer or service providers where the warranty repair can be performed.

CALIFORNIA EMISSION CONTROL WARRANTY STATEMENT YOUR WARRANTY RIGHTS AND OBLIGATIONS

The California Air Resources Board and Fuji Heavy Industries Ltd. (herein "FUJI") are pleased to explain the emission control system warranty on your 2001 and later Small Off-Road engine (herein "engine"). In California, the engine must be designed, built and equipped to meet the State's stringent anti-smog standards. FUJI must warrant the emission control system on your engine for the periods of time described below, provided there has been no abuse, neglect or improper maintenance of your engine. Your emission control system may include parts such as the carburetor or fuel-injection system, and the ignition system. Also included may be hoses, belts, connectors and other emission-related assemblies. Where a warrantable condition exists, FUJI will repair your engine at no cost to you including diagnosis, parts and labor.

MANUFACTURER'S WARRANTY COVERAGE :

The 2001 and later engines are warranted for two (2) years. If any emission related part on your engine is defective, the part will be repaired or replaced by FUJI.

OWNER'S WARRANTY RESPONSIBILITIES :

-As the engine owner, you are responsible for the performance of the required maintenance listed in your Owner's Manual. FUJI recommends that you retain all receipts covering maintenance on your engine, but FUJI cannot deny warranty solely for the lack of receipts or for your failure to ensure the performance of all scheduled maintenance.

-As the engine owner, you should ,however, be aware that FUJI may deny you warranty coverage if your engine or a part has failed due to abuse, neglect, improper maintenance or unapproved modifications.

-You are responsible for presenting your engine to a service dealer or warranty station authorized by ROBIN AMERICA Inc. 940 Lively Blvd., Wood Dale, IL 60191 (herein ROBIN AMERICA) as soon as a problem exists. The warranty repairs should be completed in a reasonable amount of time, not to exceed 30 days.

If you have any questions regarding your warranty rights and responsibilities, you should contact the Robin America Inc. Customer Service Department at 1-630-350-8200

LIMITED WARRANTY

on Emission Control Systems

– California Only –

FUJI warrants to the owner of the 2001 and later engine that the engine (1) has been designed, built and equipped so as to conform at the time of manufacture with the applicable regulations of the California Air Resources Board, and (2) is free from defects in materials and workmanship that could cause it to fail to conform with those regulations as may be applicable in the terms and conditions stated below.

A. COMMENCEMENT DATE

The warranty period begins on the date the engine is delivered to a first retail purchaser.

B. LENGTH OF COVERAGE

FUJI warrants to a first retail purchaser and each subsequent purchaser that the engine is free from defects in materials and workmanship that cause the failure of a warranted emission-related part for a period of two (2) years after the date of delivery to the first retail purchaser.

C. WHAT IS COVERED :

1. REPAIR OR REPLACEMENT PARTS

Repairs and replacement of any warranted part will be performed at no charge to you by an authorized service dealer or a warranty station. You may contact the Robin America Inc. Customer Service Department at 1-630-350-8200 to obtain the name of the nearest appropriate location where your warranty repairs are performed.

2. WARRANTY PERIOD

This warranty continues for a period of two (2) years and applies only to the repair, replacement or adjustment of the component parts that are not scheduled for replacement as required maintenance. Further, component parts which are scheduled only for regular inspection to the effect of "repair or replace as necessary" are warranted for the warranty period. Any warranted part which is scheduled for replacement as required maintenance is warranted for the period of time up to the first scheduled replacement point for that part.

3. DIAGNOSIS

You will not be charged for diagnostic labor that leads to the determination that a warranted part is defective, if the diagnostic work is performed at an authorized service dealer or warranty station.

4. DAMAGES

If a warranted part failed causing damage to other engine components, consult an authorized warranty station.

D. WHAT IS NOT COVERED

1. This limited warranty does not cover any part which malfunctions, fails or is damaged due to failure to follow the maintenance and operating instructions set forth in the 2001 and later Owner's Manual including:

- (1) improper or inadequate maintenance of any warranted parts
- (2) improper installation, adjustment or repair of the engine or of any warranted part unless performed by an authorized service dealer
- (3) failure to follow recommendations on fuel use contained in the 2001 and later Owner's Manual

- (4) repairs performed outside of the authorized warranty service dealers
 - (5) use of parts which are not authorized by FUJI.
2. Add-on or modified parts
This warranty does not cover any part that malfunctions, fails or is damaged due to alterations by changing, adding to or removing parts from the engine.
3. Expenses incurred by processing warranty claims
FUJI, any authorized service dealer and warranty station shall not be liable for any loss of use of the engine, for any alternative usage, for any damage to goods, loss of time or inconvenience.

E. HOW TO FILE A CLAIM

All repairs qualifying under this Limited Warranty must be performed by a dealer who sold you the engine or warranty station authorized by ROBIN AMERICA. In the event that any emission-related part is found to be defective during the warranty period, you must notify the Robin America Inc. Customer Service Department at 1-630-350-8200 and you will be advised of the appropriate warranty service facilities where the warranty repair is to be performed.

F. WHERE TO OBTAIN WARRANTY SERVICE

It is recommended that warranty service be performed by the authorized dealer who sold you the engine, although warranty service will be performed by any authorized service dealers or warranty stations anywhere in the United States. When warranty repair is needed, the engine must be brought to an authorized service dealer or warranty station's place of business during normal business hours. In all cases, a reasonable time, not to exceed 30 days, must be allowed for the warranty repair to be completed after the engine is received by the authorized service dealer or warranty station.

G. MAINTENANCE, REPLACEMENT AND REPAIR OF EMISSION-RELATED PARTS

Only warranted engine replacement parts approved by FUJI should be used in the performance of any warranty maintenance or repairs on emission-related parts. If other than authorized parts are used for maintenance, replacement or repair of components affecting emission control, you should assure yourself that such parts are warranted by their manufacturer to be equivalent to authorized parts in performance and durability. FUJI, however, assumes no liability under this warranty with respect to parts other than authorized parts. The use of non-authorized replacement parts does not invalidate the warranty on other components unless the non-authorized parts cause damage to warranted parts.

H. PARTS COVERED UNDER THE CALIFORNIA EMISSIONS WARRANTY

- (1) Fuel Metering System
 - (i) Carburetor and internal parts (and/or pressure regulator or fuel injection system).
 - (ii) Air/fuel ratio feedback and control system, if applicable.
 - (iii) Cold start enrichment system, if applicable.
 - (iv) Regulator assy (gaseous fuel, if applicable)
- (2) Air Induction System
 - (i) Intake manifold, if applicable
 - (ii) Air filter.
- (3) Ignition System
 - (i) Spark plugs.
 - (ii) Magneto or electronic ignition system.
 - (iii) Spark advance/retard system, if applicable.
- (4) Exhaust manifold, if applicable

(5) Miscellaneous Items Used in Above Systems

- (i) Electronic controls, if applicable
- (ii) Hoses, belts, connectors, and assemblies.
- (iii) Filter lock assy (gaseous fuel, if applicable)

I. MAINTENANCE STATEMENTS

It is your responsibility to have all scheduled inspection and maintenance services performed at the times recommended in the 2001 and later Owner's Manual and to retain proof that inspection and maintenance services are performed at the times when recommended. FUJI will not deny a warranty claim solely because you have no record of maintenance; however, FUJI may deny a warranty claim if your failure to perform required maintenance resulted in the failure of warranted part. The proof which you maintain should be given to each subsequent owner of the engine. You are responsible for performing the scheduled maintenance described below based on the procedures specified in the 2001 and later Owner's Manual. The scheduled maintenance below is based on a normal engine operating schedule.

PROCEDURE	INTERVAL
1) Clean engine and check bolts & nuts	: Every 8 hours (daily)
2) Check and refill engine oil	: Every 8 hours (refill daily up to upper limit)
3) Change engine oil	: Initial 20 hours and every 50 hours afterward
4) Change engine oil filter, if applicable	: Initial 20 hours and every 200 hours thereafter
5) Check muffler exhaust outlet, clean if necessary	: Every 50 hours or weekly
6) Clean spark plug	: Every 50 hours (weekly)
7) Clean air cleaner	: Every 50 hours
8) Check battery electrolyte fluid level	: Every 50 hours
9) Clean fuel filter (and fuel tank, if applicable)	: Every 200 hours (Monthly)
10) Clean and adjust spark plug and electrodes	: Every 200 hours (Monthly)
11) Replace air cleaner element, if applicable	: Every 200 hours
12) Clean carburetor	: Every 500 hours
13) Remove carbon from cylinder head	: Every 500 hours
14) Adjust valve clearance, if applicable	: Every 500 hours
15) Check and adjust valve seats	: Every 500 hours
16) Replace spark plug	: Every 500 hours
17) Replace fuel lines	: Every 1000 hours (Yearly)
18) Overhaul engine	: Every 1000 hours

Note : More frequent maintenance may be necessary under dusty, dirty or severe conditions.

FOREWORD

Thank you very much for purchasing a **ROBIN ENGINE**.

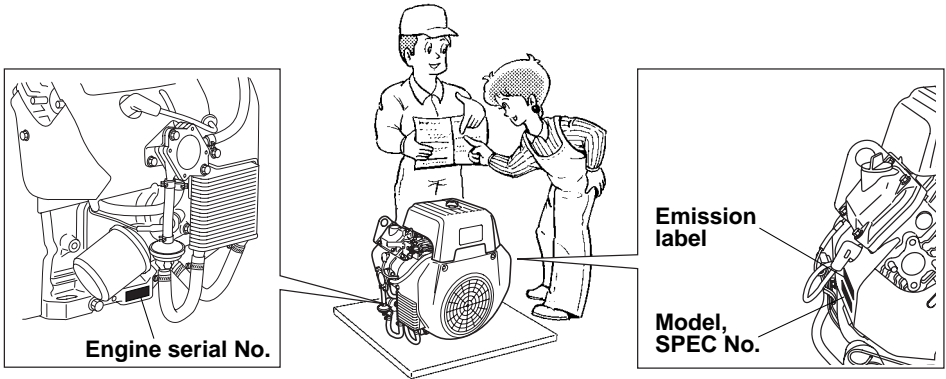

Your ROBIN ENGINE can supply the power to operate various sorts of machines and equipment.

Please take a moment to familiarize yourself with the proper operation and maintenance procedures in order to maximize the safe and efficient use of this product.

Due to constant efforts to improve our products, certain procedures and specifications are subjected to change without notice.

When ordering spare parts, always give us the MODEL, SPECIFICATION and SERIAL NUMBER of your engine.

Please fill in the following blanks after checking the specification number on your engine.

SPEC NO.

E	H																		
---	---	--	--	--	--	--	--	--	--	--	--	--	--	--	--	--	--	--	--







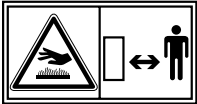
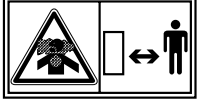
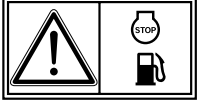

SERIAL NO.

--	--	--	--	--	--	--	--	--	--

CONTENTS

1. SAFETY PRECAUTIONS	1
2. COMPONENTS	4
3. PRE-OPERATION CHECKS	5
4. BATTERY INSTALLATION	7
5. OPERATING YOUR ENGINE	9
6. EASY TROUBLESHOOTING	12
7. MAINTENANCE SCHEDULE	14
8. "HOW-TO" MAINTENANCE	16
9. PREPARATIONS FOR STORAGE	20
10. SPECIFICATIONS	21

SYMBOLS

	<p><i>Read the owner's manual.</i></p>		
	<p><i>Stay clear of the hot surface.</i></p>		
	<p><i>Exhaust gas is poisonous. Do not operate in an unventilated area.</i></p>		
	<p><i>Stop the engine before refueling.</i></p>		
	<p><i>Fire, open flame and smoking prohibited.</i></p>		
	<p><i>On (Run)</i></p>		<p><i>Plus ; positive polarity</i></p>
	<p><i>Off (Stop)</i></p>		<p><i>Battery</i></p>
	<p><i>Engine oil</i></p>		<p><i>Engine start (Elec- tric start)</i></p>
	<p><i>Add oil</i></p>		

1. SAFETY PRECAUTIONS

Please make sure you review each precaution carefully.

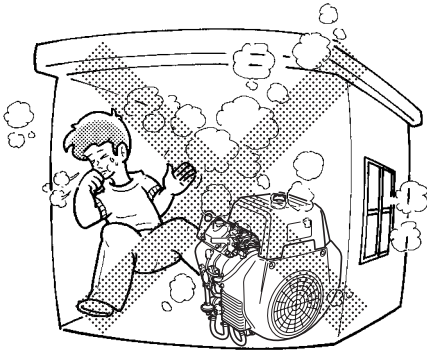

EXHAUST PRECAUTIONS

Never inhale exhaust gas. It contains carbon monoxide, a colorless, odorless and extremely dangerous gas which can cause unconsciousness or death.

Never operate the engine indoors or in a poorly ventilated area, such as tunnel, cave, etc.

Exercise extreme care when operating the engine near people or animals.

Keep the exhaust pipe free of foreign objects.

REFUELING PRECAUTIONS

Be sure to stop the engine prior to refueling.

Do not overfill the fuel tank.

If fuel is spilt, wipe it away carefully and wait until the fuel has dried before starting the engine.

After refueling, make sure that the fuel cap is secured to prevent spillage.

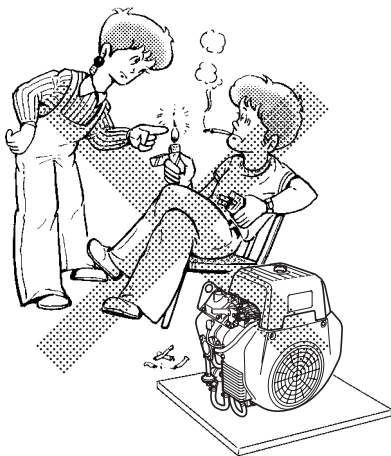

FIRE PREVENTION

Do not operate while smoking or near an open flame.

Do not use around dry brush, twigs, cloth rags, or other flammable materials.

Keep the engine at least 3 feet (1 meter) away from buildings or other structures.

Keep the engine away from flammables and other hazardous materials (trash, rags, lubricants, explosives).

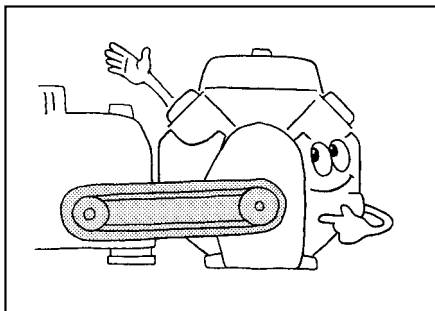

PROTECTIVE COVER

Place the protective covers over the rotating parts.

If rotating parts such as the drive shaft, pulley, belt, etc. are left exposed, they are potentially hazardous.

To prevent injury, equip them with protective covers or shrouds.

Be careful of hot parts.

The muffler and other engine parts become very hot while the engine is running or just after it has stopped. Operate the engine in a safe area and keep children away from the running engine.

Never make adjustments on the machinery while it is connected to the engine, without first removing the ignition cable from the spark plug. Turning the crankshaft by hand during adjusting or cleaning might start the engine, and the machinery with it, causing serious injury to the operator.

Never run the engine with governor disconnected, or operate at speeds in excess of 3600 rpm load.

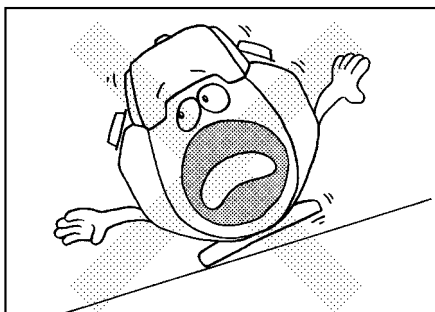

SURROUNDINGS

Operate the engine on a stable, level surface free of small rocks, loose gravel, etc.

NOTE

Operating the engine at a steep incline may cause seizure due to improper lubrication even with a maximum oil level.

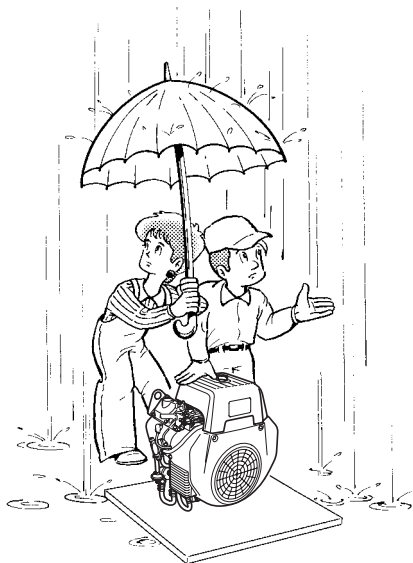

Drain the fuel when transporting the engine.

Do not move the engine while in operation when it has been removed from the equipment.

Keep the unit dry (do not operate it in rainy conditions).

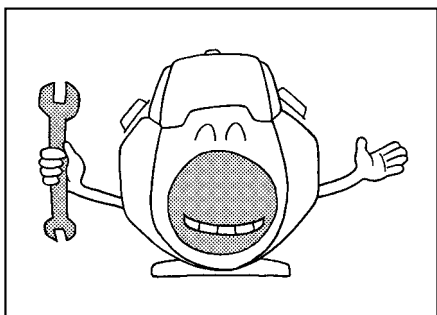

PRE-OPERATION CHECKS.

Carefully check fuel hoses and connections for looseness and fuel leakage. Leaking fuel creates a potentially dangerous situation.

Check bolts and nuts for looseness. A loose bolt or nut may cause serious engine trouble.

Check the engine oil daily and refill if necessary.

Check the fuel level and refill if necessary.

Do not overfill the tank.

Wear snug fitting working clothes when operating the engine.

Loose aprons, towels, belt, etc., may be caught in the engine or drive train, causing a dangerous situation.

2. COMPONENTS

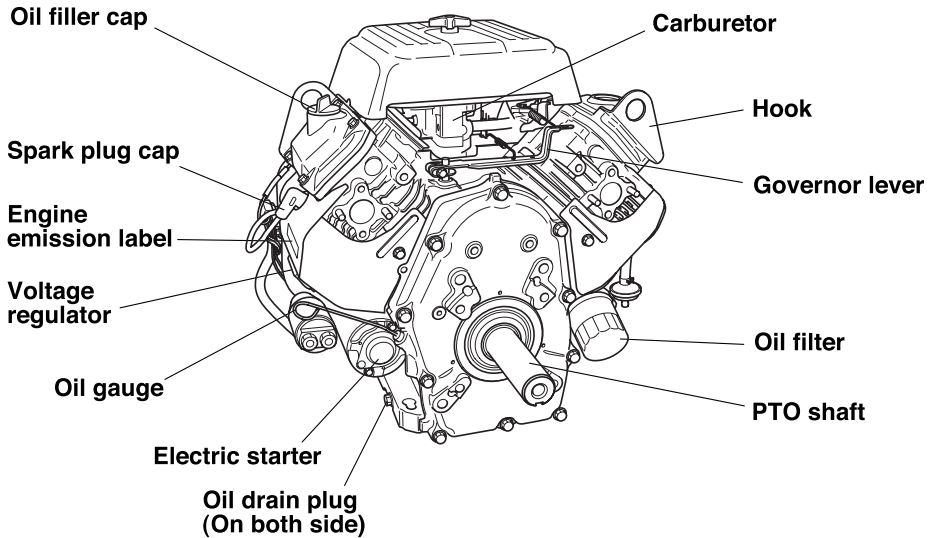
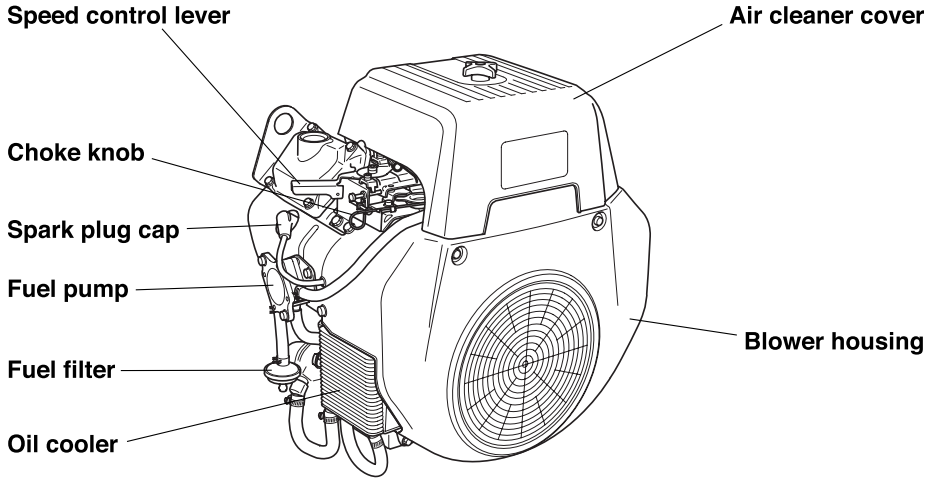

REMARKS :

Fuel tank, valve (sediment bowl type is recommended), fuel hoses, and fuel filter are required for connecting fuel source to carburetor.

A battery rated at 12V-36AH or larger with the specified cable are required for electric starter operation. Make the proper electrical wiring arrangements before normal engine operation. See Section 4 in this manual for instructions.

3. PRE-OPERATION CHECKS

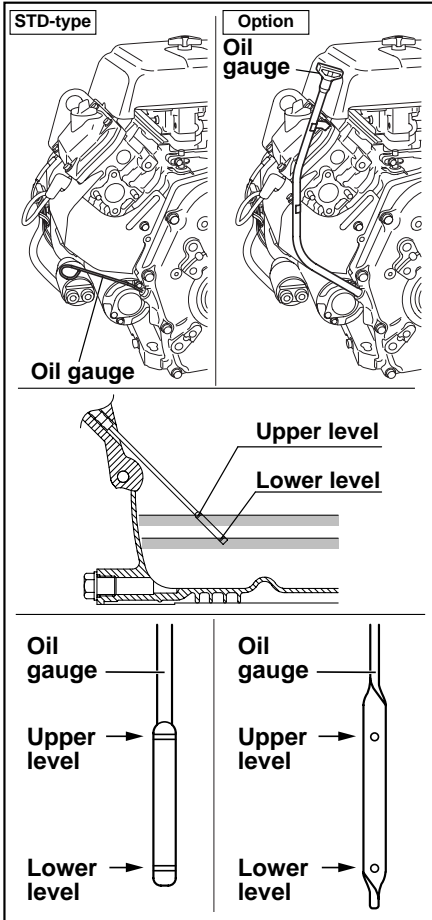

CHECK ENGINE OIL (DAILY)

Before checking or refilling engine oil, be sure the engine is not running and is located on a stable, level surface.

If the oil level is below the lower level line on the oil gauge, refill with the proper oil (see table) to the upper level.

OIL CAPACITY : 1.55 liter

When filling oil in the engine, keep the engine level and fill the oil up to the upper mark of the oil gauge. Measure the oil level with the oil gauge plugged in position.

After an oil change, run the engine, and recheck the oil level. The oil level may drop a little as the oil fills the oil filter. Fill the oil up to the upper mark of the oil gauge.

Change oil if it is contaminated. (See page 15 Maintenance Schedule.)

Use class SE (API classification) or higher grade oil.

If multi-grade oil is used, oil consumption tends to increase when the ambient temperature is high.

Single grade	5W						
	10W						
Multi grade	20W						
	#20						
	#30						
	#40						
Multi grade	10W-30						
	10W-40						
Ambient temperature	-20	-10	0	10	20	30	40°C
	-4	14	32	50	68	86	104°F

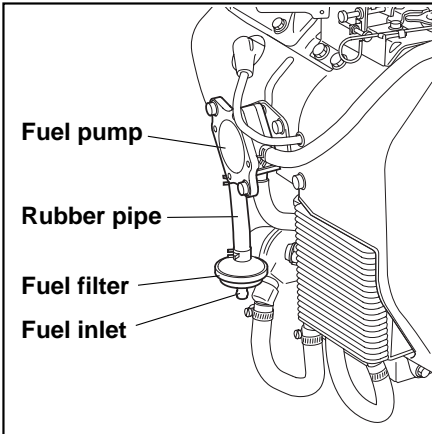

CHECK FUEL

⚠ WARNING

Do not refuel while smoking, near an open flame or other potential hazards.

The fuel tank shall be provided separately, because the engine is not equipped with a fuel tank.

A fuel valve and fuel filter should be connected between the fuel tank and fuel pump.

Securely connect with fuel hoses to the fuel pump to prevent leakage.

Fuel tank may be mounted up to .66 meters (2 feet) below the carburetor.

If the fuel tank is mounted above the carburetor, a fuel shut off valve must be connected between the fuel tank and fuel pump. The fuel valve must be shut off when the engine is not operating to prevent fuel from flooding the carburetor.

A serious accident may occur if the fuel hose comes off. Properly secure the fuel line connections by completely inserting the hose onto the fittings and securing the connection with a hose clamp.

Use unleaded gasoline only.

Stop the engine and close the fuel valve before filling the fuel tank.

Wipe off any spilled fuel before starting the engine.

4. BATTERY INSTALLATION

For electric starter operation, proper electric wiring arrangements are needed before normal engine operation.

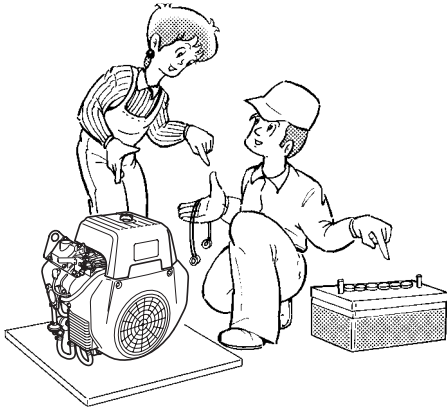

PARTS NEEDED

Use a battery rated 12V-36AH or larger.

Use a proper cable and ground wire to connect battery and key switch and electric starter.

BATTERY CABLE

CABLE LENGTH	CABLE DIA.	WIRE GAUGE		
		AWG(BS) BWG	SAE	JIS
Less than 1.5 m	7.3 mm	1	6	AV15
1.5 m to 2.5 m	8.5 mm	0	4	AV20
2.5 m to 4.0 m	10.8 mm	3/0	2	AV30

GROUND WIRE, use a flat braided wire of 0.03 sq. in. or larger sectional area. (SAE GAUGE 4)

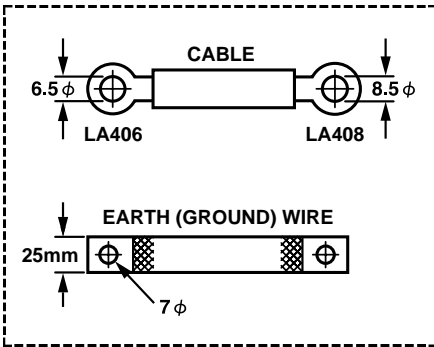

KEY SWITCH CABLE

CABLE LENGTH	CABLE DIA.	WIRE GAUGE		
		AWG(BS) BWG	BWG	JIS
Less than 1.5 m	1.5 mm	14	16	AV1.25
1.5 m to 3.0 m	1.9 mm	12	14	AV2
3.0 m to 5.0 m	2.4 mm	10	13	AV3

WIRING

Connect positive terminal of the electric starter and positive terminal of the battery with battery cable.

Ground negative terminal of the battery to the body of engine or machine with ground wire.

NOTE

Tighten bolts and nuts on terminals securely so they will not be loosened by vibration.

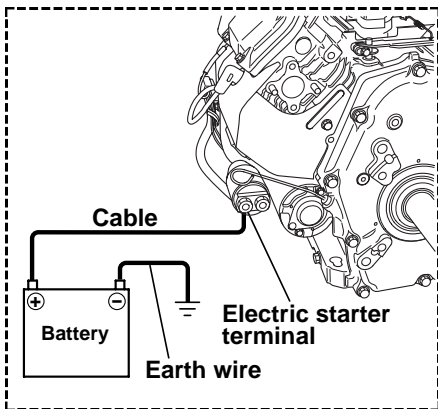

WIRING DIAGRAM

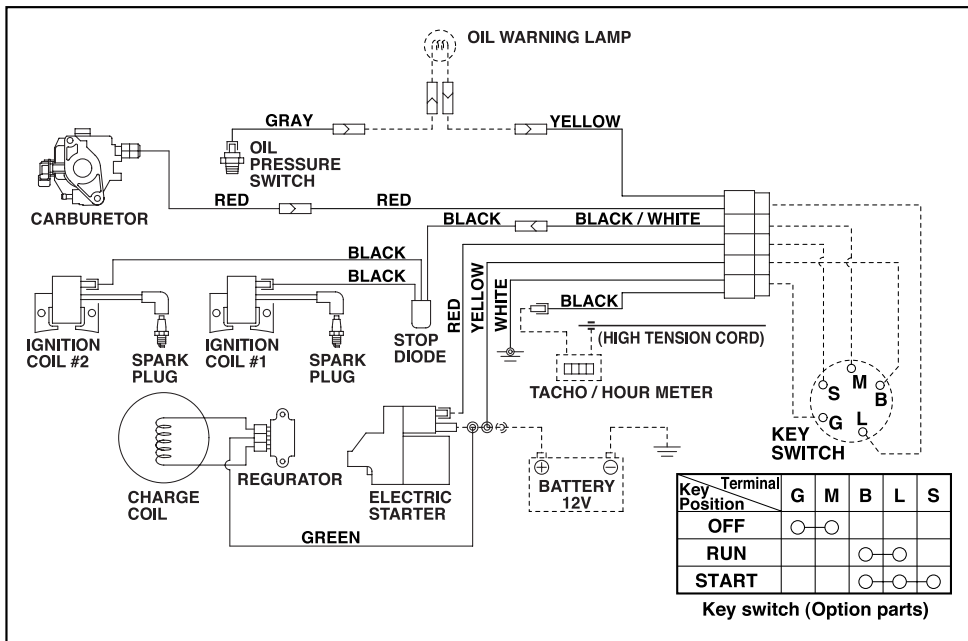

Optional hardware shown by dotted lines. Select wires of proper gauge and connect battery as shown by the dotted line in the wiring diagram.

5. OPERATING YOUR ENGINE

NOTE

Following operating method is for the STD type speed control lever. As to the fixed type speed control lever (exp. Generator spec.), do not move it otherwise the generator component such as voltage regulator may be damaged.

STARTING

FUEL VALVE

1

(Provided by the equipment manufacturer)

Open the fuel valve.

SPEED CONTROL LEVER

2

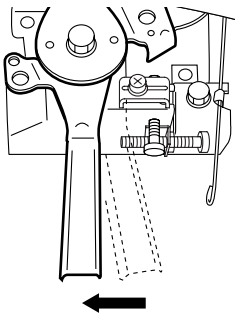

Set the speed control lever 1/3 of the way towards the high speed position.

CHOKE KNOB

3

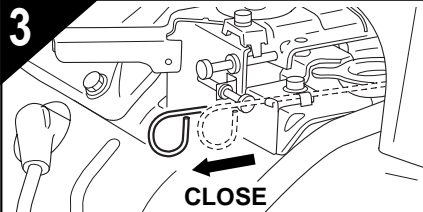

Pull the choke knob.

If the engine is cold or the ambient temperature is low, pull the choke knob fully.

If the engine is warm or the ambient temperature is high, pull the choke knob half-way, or keep it fully open.

ELECTRIC STARTER

4

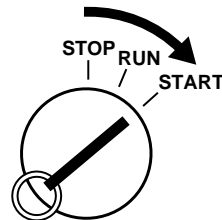

Turn the key switch to the "START" position.

Do not operate the electric starter continuously for more than 5 seconds, even if the engine does not start.

If the engine failed to start, set the key to the "RUN" position and wait for about 10 seconds before retrying.

Never turn the key switch to the "START" position while engine is running.

CHOKE KNOB

5

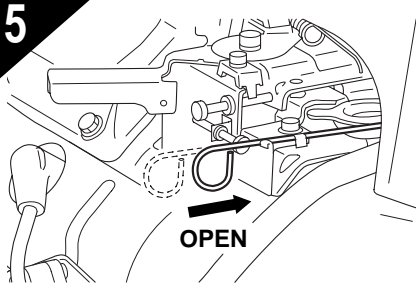

After starting the engine, gradually open choke by pushing the choke knob and finally keep it fully opened.

Do not fully open the choke immediately when the engine is cold or the ambient temperature is low, because the engine may stop.

RUNNING

SPEED CONTROL LEVER

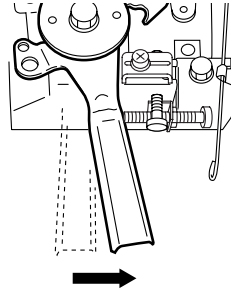

After the engine starts, set the speed control lever at the low speed position and warm it up without load for a few minutes.

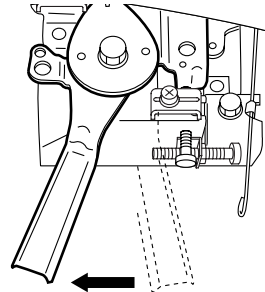

Gradually move the speed control lever toward the high speed position and set it at the required engine speed.

NOTE :

Whenever high speed operation is not required, slow the engine down (idle) by moving the speed control lever to save fuel and extend engine life.

STOPPING

SPEED CONTROL LEVER

1

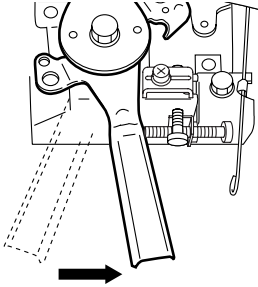

Set the speed control lever at the low speed position and allow the engine to run at low speed for 2 or 3 minutes before stopping.

FUEL VALVE

3

Close the fuel valve.

ELECTRIC STARTER

2

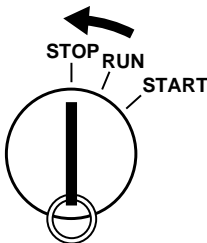

Turn the key switch to the "STOP" position.

STOPPING ENGINE WITH THE FUEL VALVE

Close the fuel valve while the engine is running and wait until the engine stops.

Set the key switch to the "STOP" position after stopping the engine.

This procedure eliminates the fuel from the carburetor.

Avoid allowing the fuel to remain in the carburetor over long periods, or the passages of the carburetor may become clogged and malfunctions may result.

6. EASY TROUBLESHOOTING

WHEN ENGINE WILL NOT START:

Perform the following checks before you take the engine to your Robin dealer.

If you still have trouble after completing the checks, take the engine to your nearest Robin dealer.

Is there enough compression?

If the spark plug is loose, tighten it.

Is the spark plug wet with gasoline?

1. Choke (close choke lever) and slowly start the engine for 2 or 3 seconds.
Remove the plug and check if its electrode is wet. If the electrode is wet, fuel is well supplied to your engine.
2. When the electrode is dry, check to find where the fuel is restricted.
(Check the fuel intake of the carburetor and fuel strainer intake.)
3. In case the engine does not start with well supplied fuel, try using fresh fuel.



WARNING

Wipe off spilled fuel carefully before checking the spark plug. Place spark plug as far away from spark plug hole as possible. Do not hold spark plug by hand while checking.

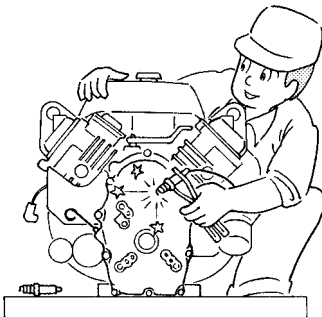

Is there a strong spark across the electrode?

1. Remove the spark plug and connect it to the plug cap.
Turn key switch to START position while grounding spark plug against engine body.
2. Try with a new spark plug if the spark is weak or there is no spark.
3. The ignition system is faulty if there is no spark with a new spark plug.
Take your engine to your nearest Robin dealer.

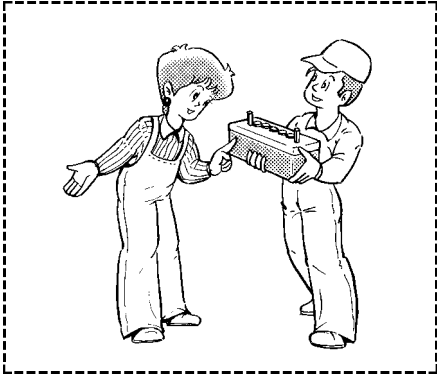

Is your battery well charged ?

Check the battery, it may be discharged and unable to operate the electric starter.

Consult your nearest dealer or service shop.

7. MAINTENANCE SCHEDULE

DAILY INSPECTION

Before running the engine, check the following service items.

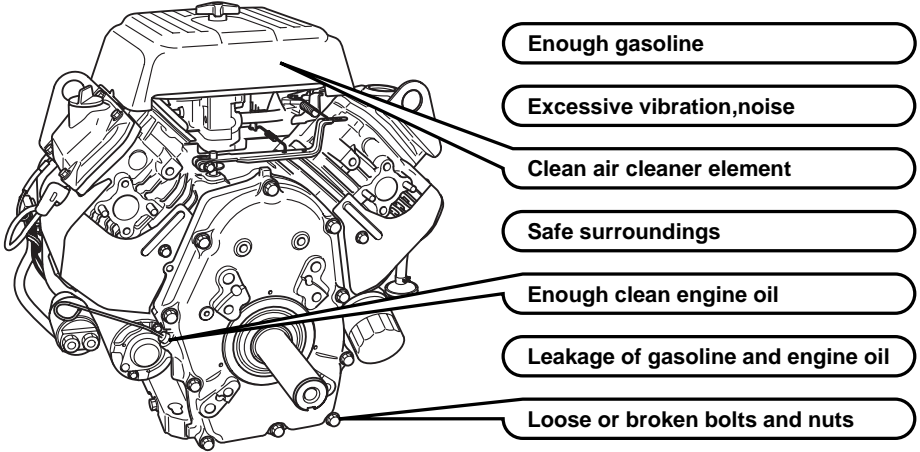

PERIODIC MAINTENANCE

Periodic maintenance is vital to safe and efficient operation of your engine. Check the table below for periodic maintenance intervals.

IT IS ALSO NECESSARY FOR THE USER OF THIS ENGINE TO CONDUCT THE MAINTENANCE AND ADJUSTMENTS ON THE EMISSION-RELATED PARTS LISTED BELOW TO KEEP THE EMISSION CONTROL SYSTEM EFFECTIVE.

The emission control system consists of the following parts:

- | | | |
|---|--|--|
| (1) Carburetor and internal parts | (4) Air cleaner elements | (8) Exhaust manifold, if applicable |
| (2) Cold start enrichment system, if applicable | (5) Spark plug | (9) Hoses, belts, connectors, and assemblies |
| (3) Intake manifold, if applicable | (6) Magneto or electronic ignition system | |
| | (7) Spark advance/retard system, if applicable | |

The maintenance schedule indicated in the following table is based on the normal engine operation. Should the engine be operated in extremely dusty condition or in heavier loading condition, the maintenance intervals must be shortened depending on the contamination of oil, clogging of filter elements, wear of parts, and so on.

Periodic Maintenance Schedule table

Maintenance Items	Every 8 hours (Daily)	Every 20 hours	Every 50 hours	Every 200 hours	Every 500 hours	Every 1000 hours
Clean engine and check bolts and nuts	(Daily)					
Check and refill engine oil	(Refill daily to upper level)					
Change engine oil (*Note 1)		(Initial)				
Replace engine oil filter (*Note 1)		(Initial)				
Check battery electrolyte fluid level						
Clean spark plug						
Clean air cleaner						
Replace air cleaner element						
Clean fuel strainer						
Clean and adjust spark plug and electrodes						
Replace spark plug						
Remove carbon from cylinder head						
Clean and adjust carburetor						
Clean engine base (oil pan)						
Check and adjust valve clearance						
Replace fuel lines						(Yearly)
Overhaul engine (*Note 2)						

*Note 1 : Initial oil change and oil filter replacement should be performed after 20 hours of operation.
 Thereafter change oil every 50 hours and replace oil filter 200 hours.
 Before changing oil, check for a suitable way to dispose of old oil. Do not pour it down into sewage drains, onto garden soil or into open streams. Your local zoning or environmental regulations will give you more detailed instructions on proper disposal.

*Note 2 : As to the procedures, please refer to the Service Manual or consult your nearest ROBIN service dealer.

*Note 3 : More frequent oil changing, oil filter replacement and air cleaner service on replacement may be necessary depending on operating conditions.
 This would include dusty environment, high ambient temperature, heavy engine loading.

8. "HOW-TO" MAINTENANCE

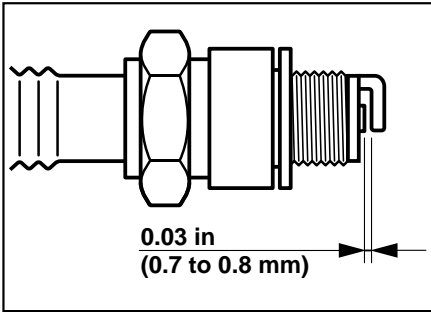

INSPECTING THE SPARK PLUG

Clean off carbon deposits on the spark plug electrode using a plug cleaner or wire brush.

Check electrode gap.

Adjust gap to : 0.03 inches (0.7mm to 0.8mm)

Use a proper spark plug :
NGK BPR6ES

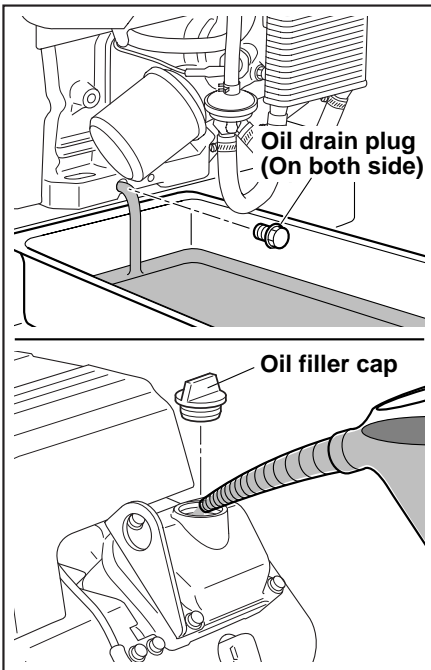

ENGINE OIL CHANGE

Initial oil change

• • • • After 20 hours of operation

Thereafter

• • • • Every 50 hours of operation

1. When changing oil, stop the engine and loosen the drain plug.
2. Re-install the drain plug before refilling oil.
3. Refer to the recommended oil table on page 5.
4. Always use the best grade and clean oil. Contaminated oil, poor quality oil and shortage of oil cause damage to engine or shorten the engine life.

OIL CAPACITY : 1.55 liter

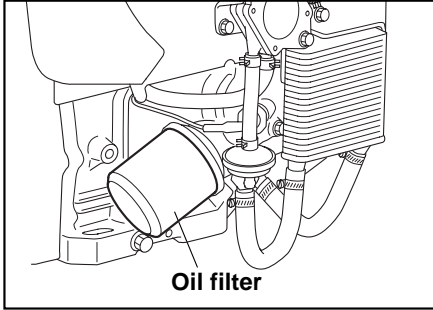

ENGINE OIL FILTER REPLACEMENT

Initial engine oil filter replacement should be performed after 20 hours of operation. Thereafter replace the engine oil filter every 200 hours.

When installing a new oil filter, apply oil to O-ring, attach the oil filter in position and tighten 2/3 turns by hand or with wrench after touching the O-ring to the sealing surface of engine.

Run the engine for a minute ; stop the engine and check for oil leakage around the oil filter and recheck the oil level.

CAUTION

To prevent injury, pay attention to the spilled hot engine oil when replacing engine oil filter.

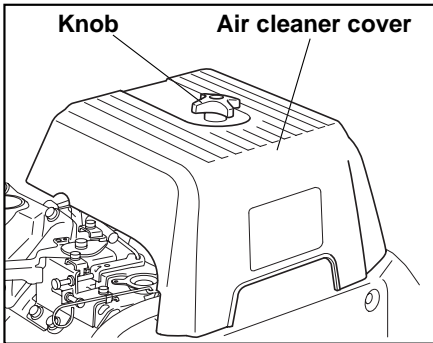

CLEANING AIR CLEANER

A dirty air cleaner element will cause starting difficulty, power loss, engine malfunctions, and shorten engine life extremely.

Always keep the air cleaner element clean. Replaced the air cleaner element set more often in dusty environments.

The air cleaner paper inner element and urethane foam outer element can be removed after removing knob and air cleaner cover. When installing, set the paper element and urethane foam on the air cleaner base. Check that the grommet is in position, and then install the cover with knob tightened securely.

Urethane Foam cleaning

Wash and clean the urethane foam in kerosene. Saturate in a mixture of 3 parts kerosene and 1 part engine oil, and then squeeze to remove excess oil. Clean or replace the urethane foam element every 50 hours. (more often in dusty environments)

Paper element

Clean by tapping gently to remove dirt and blow off dust. Never use oil. Clean or replace the paper element every 50 hours of operation, and replace element set every 200 hours.

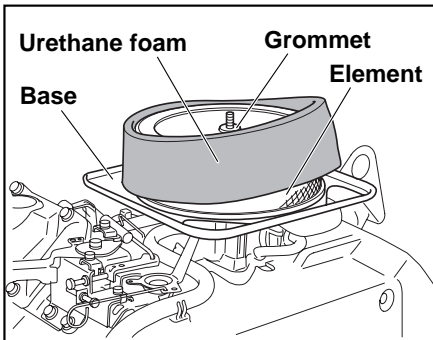

Clean and replace air cleaner elements more often when operating in dusty environments.

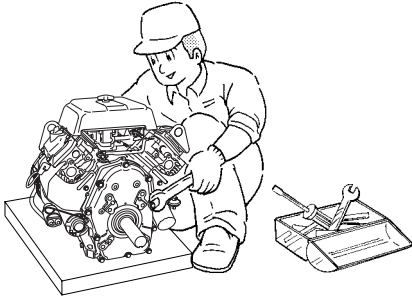

CHECKING BOLTS, NUTS AND SCREWS

Retighten loose bolts and nuts.
 Check for fuel and oil leaks.
 Replace damaged parts with new ones.
 Keep safety in your mind.

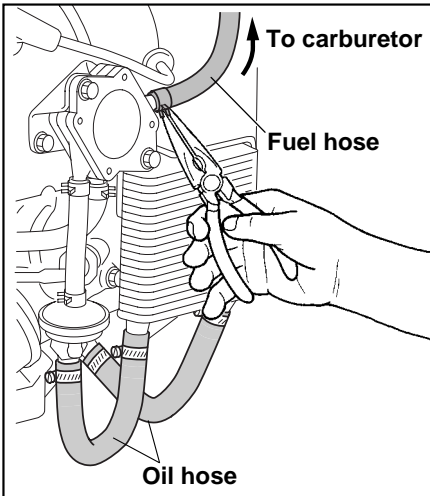

FUEL AND OIL HOSE REPLACEMENT

⚠ WARNING

Take extreme caution when replacing fuel hose ; gasoline is flammable.

Replace the fuel and oil hose every 1,000 hours or every year.
 If fuel and oil hose leak is found, replace the hose immediately.

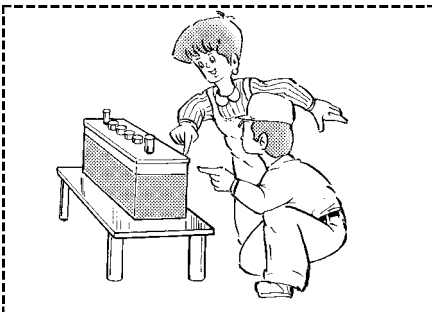

CHECKING BATTERY

⚠ WARNING

Battery electrolyte is an acid and is poisonous and corrosive.
 Serious injury results from contact with the skin, eyes or clothing.

If the electrolyte fluid is below level line, refill battery with distilled water.

HIGH ALTITUDE ENGINE OPERATION

Please have an authorized Robin America service dealer modify this engine if it is to be run continuously above 5,000 feet (1,500 meters). Failure to do so, may result in poor engine performance, spark plug fouling, hard starting, and increased emissions.

Carburetor modification by an authorized Robin America service dealer will improve performance and allow that this engine meets EPA (Environmental Protection Agency) and California ARB (Air Resources Board) emission standards throughout its useful life.

An engine converted for high altitudes can not be run at 5,000 feet or lower. In doing so, the engine will overheat and cause serious engine damage. Please have an authorized Robin America service dealer restore high altitude modified engines to the original factory specification before operating below 5,000 feet.

9. PREPARATIONS FOR STORAGE

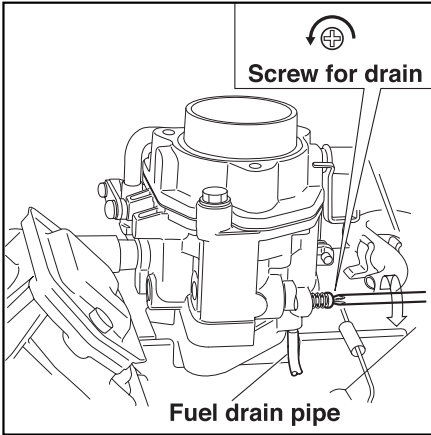

DISCHARGE FUEL (NO SMOKING !)

⚠ WARNING

Take extreme caution when draining gasoline. It is flammable.

Drain fuel from fuel tanks, carburetor and fuel line.

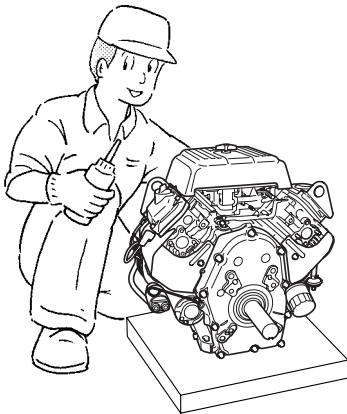

ENGINE OIL

Change the engine oil with fresh oil.

Remove the spark plug, pour about 5 cc of engine oil into the cylinder, slowly start the engine for 2 or 3 seconds, and re-install the spark plug.

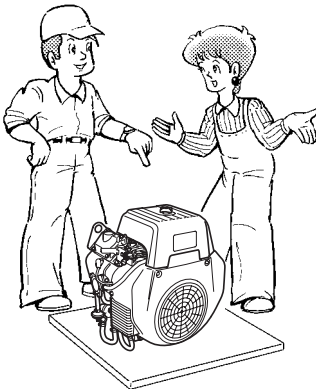

CLEAN AND STORE

Remove the spark plug wires from the spark plugs.

Slowly turn the crankshaft until resistance is felt and leave it in that position.

Clean the engine thoroughly with an oiled cloth, cover the engine, and store the engine indoors in a well ventilated, low humidity area.

10. SPECIFICATIONS

MODEL	EH72D
Type	Air-Cooled, 4-Stroke, V-Twin Cylinder, Horizontal P.T.O. shaft, OHV Gasoline Engine
Bore x stroke	2 - 3.31 in x 2.56 in (84 mm x 65 mm)
Displacement	43.9 cu in. (720 cm ³)
Continuous Output kW (HP) / rpm	13.4 (18.0) / 3600
Maximum Output kW (HP) / rpm	18.6 (25.0) / 3600
Max.Torque N·m (kgf·m)/ rpm	53.6 (5.5) / 2500
Direction of Rotation	Counterclockwise as viewed from P.T.O. shaft side
Lubricant	Automobile Engine Oil SAE #20, #30 or 10W-30 ; Class SE or higher
Capacity of Lubricant	1.55 Liter
Fuel	Automobile Unleaded Gasoline
Spark plug	NGK BPR6ES
Starting System	Electric Starter
Dry Weight	101.3 lb. (46 kg)
Dimension (L x W x H)	12.5 in x 18.8 in x 18.7 in (317 mm x 477 mm x 475 mm)
Valve Clearance (Intake & Exhaust)	0.0039 ± 0.0012 in (0.1 ± 0.03 mm) Note : Adjust the valve clearance while the engine is cold.
Emissions Durability Period (California only)	500 hours





 **FUJI HEAVY INDUSTRIES LTD.**

INDUSTRIAL PRODUCTS COMPANY

4-410 Asahi, Kitamoto-shi,

Saitama, 364-8511, Japan

Phone +81(48) 593-7798

Fax +81(48) 593-7946

Web site <http://www.fhi.co.jp/robin/>

PRINTED IN JAPAN

July 2002 CE504
Download from Www.Somanuals.com. All Manuals Search And Download.

Free Manuals Download Website

<http://myh66.com>

<http://usermanuals.us>

<http://www.somanuals.com>

<http://www.4manuals.cc>

<http://www.manual-lib.com>

<http://www.404manual.com>

<http://www.luxmanual.com>

<http://aubethermostatmanual.com>

Golf course search by state

<http://golfingnear.com>

Email search by domain

<http://emailbydomain.com>

Auto manuals search

<http://auto.somanuals.com>

TV manuals search

<http://tv.somanuals.com>