

Replacement Parts List

NOTE: If requested color is not available, similar color will be substituted.

Part	Cost	Quantity	Total Cost
Crotch Strap/Buckle	\$4.99	X _____ = \$ _____	
Harness Strap\$2.00	X _____ = \$ _____	
Seat Pad\$39.99	X _____ = \$ _____	
(Includes headrest, harness covers, and pillow)			
Harness Retainer	...\$1.50	X _____ = \$ _____	
Locking Clip\$2.50	X _____ = \$ _____	
Top Anchorage (Tether) Kit\$9.99	X _____ = \$ _____	
Latch Kit\$24.99	X _____ = \$ _____	
Instructions\$0.00	X _____ = \$ _____	

Merchandise Total \$ _____

Shipping and handling: \$ _____

Up to \$25.00\$5.95	\$100.01 to \$150.00\$10.95
\$25.01 to \$50.00\$6.95	\$150.01 to \$200.00\$11.95
\$50.01 to \$75.00\$8.95	\$200.01 and up\$13.95
\$75.01 to \$100.00\$9.95	Outside Continental USA	\$10.00

Sales Tax \$ _____
 (Indiana, California, Arkansas, and Massachusetts residents add applicable sales tax.)

Grand Total \$ _____

No shipping and handling on instructions for quantities under 6. Add \$.50 for each instruction over 6, then add applicable shipping and handling.

Fill Out For Credit Card

Visa Mastercard

Card Exp. Date: _____

Cardholder's Name: _____

Card Number: _____

Signature: _____

CUT ON DOTTED LINE

Eng. 4358-3412E

Summit Deluxe Highback Booster Instruction Manual

www.djgusa.com

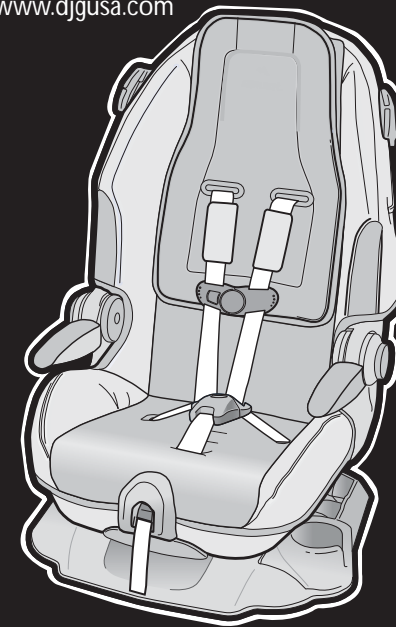

This child restraint is designed for use by children whose:

Weight:
22-100 pounds
(10.1-45.4 kg)

Height:
34-52 inches
(85.1-132.1 cm)

**Forward-Facing
Use Only**

Read all instructions
BEFORE USING
this child restraint.

KEEP INSTRUCTIONS FOR FUTURE USE.

▲ IMPORTANT!

Failure to follow the warnings on the labels and in the instruction manual can result in the death or serious injury of your child.

Para recibir las instrucciones en español, llame al
1-800-544-1108 o solicítase por escrito al dirección por arriba.

Before You Begin...

Thank you for choosing this car seat, referred to throughout this manual as a child restraint. The DJG family is committed to creating a child restraint with the most comfort and convenience available today.

Remember, parents are a child's first teachers and examples. If you always buckle your seat belt, your child will think it is the natural thing to do. Make it a firm rule that the vehicle does not go until everyone is buckled up. Make no exceptions.

No one can predict if use of a child restraint will prevent injury or death in a particular crash. However, combined with careful driving, proper use of a child restraint can lower a child's risk of injury or death in most crashes.

Your child's safety is worth the time it will take to read and follow these instructions. After reading, if you still have questions or have any problems with this child restraint, please contact our Consumer Relations Department at:

Dorel Juvenile Group, Inc.

Website: www.djgusa.com
 Fax: 1-800-207-8182
 Mailing Address: Dorel Juvenile Group, Inc.
 P.O. Box 2609
 Columbus, IN 47202-2609
 Telephone: 1-800-544-1108
 7 A.M. to 6 P.M. EST M-TH
 7 A.M. to 4:30 P.M. EST FRI









On the back of the shell there is an expiration date for use of this child restraint. Do not use this seat after the expiration date.

Table of Contents

Warnings.....	2-4
General and Warm Weather Use.....	4
Registration and Recall	5
Aircraft Installation	5
Understanding Your Vehicle	6-7
Child Restraint Parts.....	8-9
Choosing Restraint and Position	10
Preparing Child Restraint to Fit Your Child	11
Harness and Headrest Height	12-13
Reclining the Child Restraint	14
Rotating Armrests	14
Securing Your Child in Child Restraint	15-16
Removing Child From Child Restraint	17
Choosing LATCH or Vehicle Belts.....	18
Knowing Your Vehicle Belts	19-20
Locking Clip	21-22
Forward-Facing Use	23
Forward-Facing Installation	24
Vehicle Belt	25-26
LATCH.....	27-29
Adjusting the Top Anchorage (Tether) Strap.....	30-31
Belt-Positioning Booster Use	33
Removal of Harness	34-35
Belt-Positioning Booster Installation.....	36-37
Reinstall Harness	38-39
Removing Seat Pad for Cleaning	40-42
Troubleshooting	43
Installation Tips.....	43
Warranty	44
Replacement Parts Order Form	45-46











WARNING

Failure to follow these warnings can result in the serious injury or death of your child. To help you recognize those instructions which are most critical for your child's safety, we use this symbol :

-  According to accident statistics, children are safer when properly restrained in the rear seating positions than in the front seating positions.
-  Never place a child less than one-year old forward facing.
-  Check vehicle instructions for more information about air bag/child restraint use.
-  For vehicles with an air bag, but without a back seat, refer to your vehicle owners manual.
-  Make sure the harness height is correct for your child's size.
-  The harness must be snug.
-  The vehicle or LATCH belt must stay tight at the belt path. When you switch from one mode to the next, review the sections of this instruction manual that apply to that mode. If you don't, your child can be injured or killed.
-  Never take your child out of the child restraint or try to tend to your child's needs while the vehicle is moving. Never leave child unattended.

2

WARNING

-  Do not use a child restraint with damaged or missing parts.
-  Do not use cut, frayed or damaged harnesses.
-  Do not lubricate buckles and fasteners.
-  Do not substitute parts or try to modify the child restraint in any way.
-  Do not use a child restraint that has been in a crash. You must get a new child restraint.
-  Use the child restraint only on vehicle seats that face forward. Do not use on seats that face the sides or rear of the vehicle.
-  Check the vehicle or LATCH belt before each use. Use only if the belt can be tightened properly and securely.
-  This child restraint should be securely belted in the vehicle even when not in use. In a crash or sudden stop, an unsecured child restraint can injure other occupants.
-  Do not use this child restraint if the midpoint of your child's head is above the top of the child restraint's headrest.
-  Dorel Juvenile Group does not recommend the use of any child restraint accessories except those provided by DJG.
-  Never allow any child to play with this child restraint; it is not a toy.

3

WARNING

▲ Secure the top anchorage strap (tether) provided with this child restraint as specified in both the vehicle and this instruction manual.

▲ Do not remove any of the warning labels or other labels on the child restraint.

▲ Do not use this child restraint without the seat pad.

▲ Placing your child in a hot child restraint may result in burns.

▲ Read instructions for other warnings.

Registration and Recall Information

Child restraints could be recalled for safety reasons. You must register this restraint to be reached in a recall. Fill out the registration card attached to the child restraint or send your name, address and the restraint's model number and manufacturing date to:

Dorel Juvenile Group, Inc.
P.O. Box 2609, Columbus, IN 47202-2609
Attn: Consumer Relations or call 1-800-544-1108

You can now register your child restraint online at **www.djgusa.com**. Please do not send in your registration card if you registered your child restraint online.

For recall information, call the U.S. Government's Vehicle Safety Hotline at 1-888-327-4236 (TTY: 1-800-424-9153), or go to <http://www.NHTSA.gov>.

General and Warm Weather Use

To help protect your vehicle seat's upholstery from damage, use a towel underneath and behind child restraint.

To avoid your child being seriously burned, take the following precautions:

1. Park in the shade or where sun does not directly hit the child restraint.
2. Cover the child restraint with a sheet or blanket when not in use.
3. Check for hot seat and buckles before placing child in child restraint.

4

Aircraft Installation

This restraint is certified for aircraft use only when used with the internal harness. Do not use as a belt-positioning seat because aircraft seats do not have shoulder belts. Use on forward-facing aircraft seats only and in a position where the lap belt can be tightened securely. This child restraint is installed in an aircraft seat the same way it is installed in the vehicle.

Use the child restraint only with F.A.A. certified equipment. Contact the airline prior to taking a child restraint on board in order to comply with their specific regulations.

5

Understanding Your Vehicle

Your vehicle's features may be considerably different than those pictured here. Consult your vehicle owner's manual to help identify your vehicle's specific features.

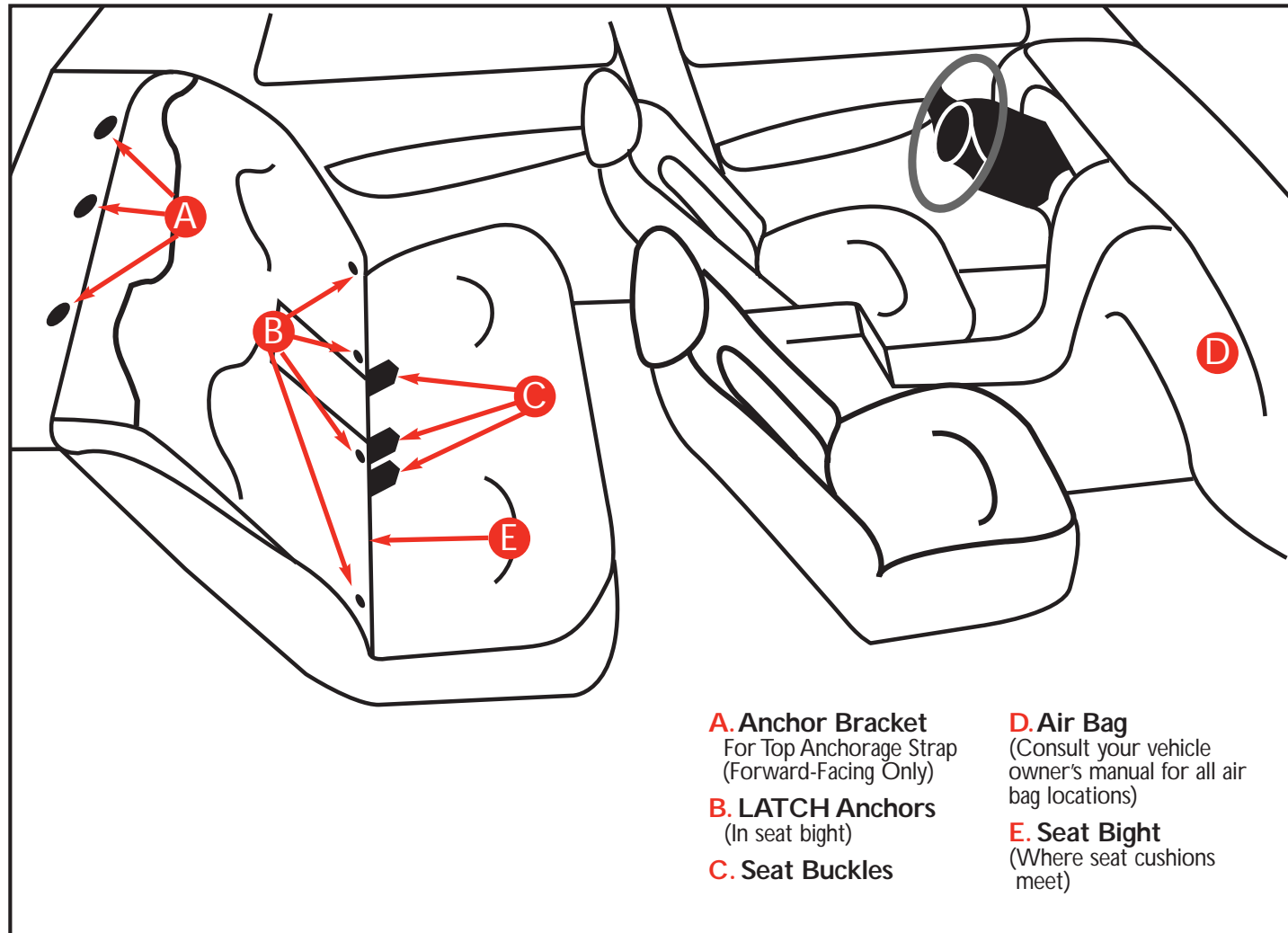

6

7

Child Restraint Parts

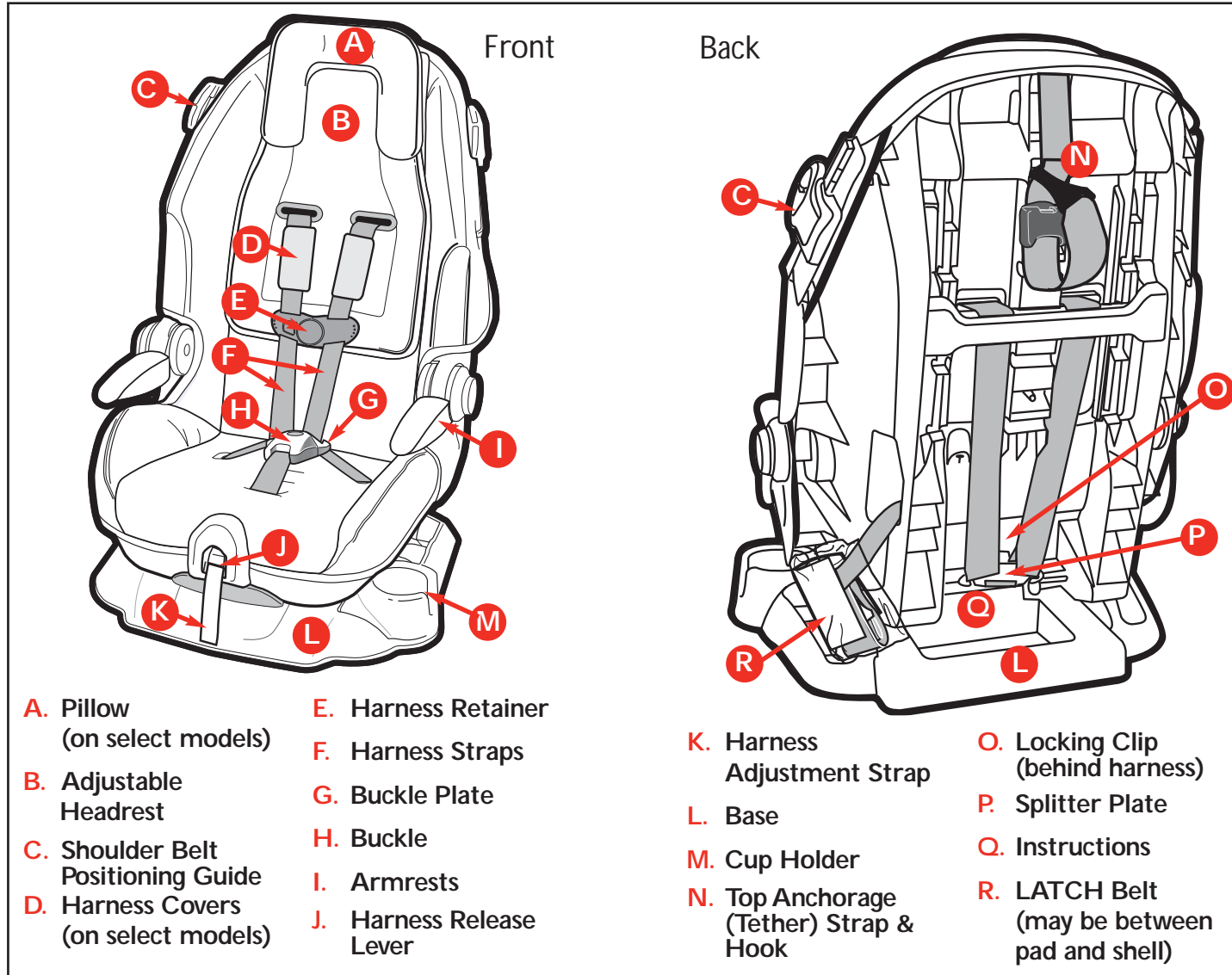

Choosing Restraint and Position

Your child's height, weight and age determine how your child restraint should be placed in the vehicle and which restraint should be used.

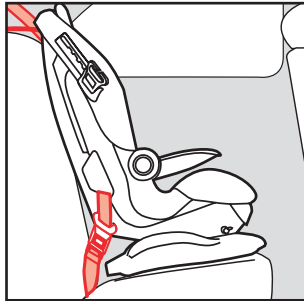

**22-40 lbs (10.1-18 kg)
34-43 in. (85.1-110 cm)
and Over 1 Year Old**

**Forward-Facing using
5-point harness**
Child and child restraint face
the front of the vehicle and
are placed in the back seat.

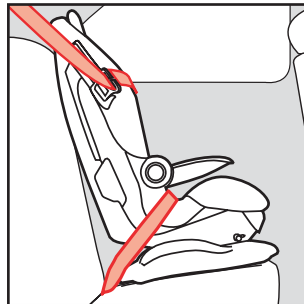

**40-100 lbs (18.1-45.4 kg)
43-52 in. (110.1-132.1 cm)
and Over 1 Year Old**

**Belt-positioning booster
using vehicle
lap/shoulder belt
combination**
Child and child restraint face
the front of the vehicle and
are placed in the back seat.
5-point harness is removed.

Preparing Child Restraint to Fit Your Child

**You MUST make these adjustments with your
child before you install the child restraint in the
vehicle.**

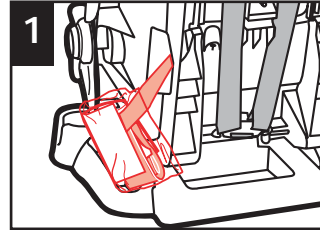

1 Make sure LATCH belt
packaging is pulled free of
child restraint shell.

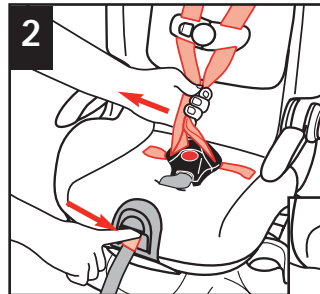

2 Loosen harness by pushing
down on the harness
release lever while pulling
out on the harness.

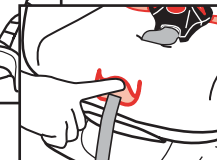

Depending on your model,
the harness release lever
may be
under a flap
on the pad in
the front of
restraint.

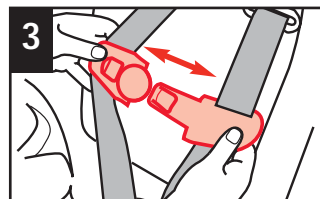

3 Press on harness retainer
release button and pull
apart.

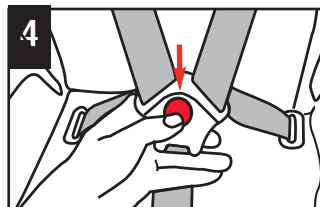

4 Press red button on
buckle to release the
buckle plates. Place
harness over sides of child
restraint.



Place the child's bottom and back flat against the child restraint. This will increase comfort and allow the harness to properly tighten.

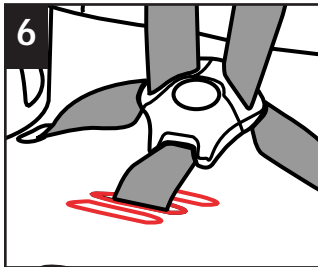

Adjust Buckle: Determine which of the three available buckle slots is both comfortable and snug. Refer to "Removal of Harness" to adjust buckle.

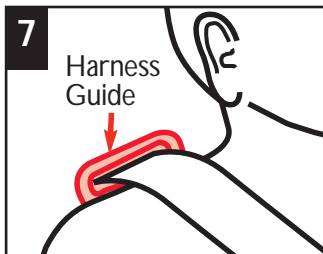

Check Harness Height
Forward-Facing Position: Harness guide must be **even with or just above** the shoulders.

If the harness is below the child's shoulders with the headrest in the 3rd highest position, the child weighs at least 40 lbs. (18.1 kg) and is over 1 year old, convert the seat to a belt-positioning booster.

12

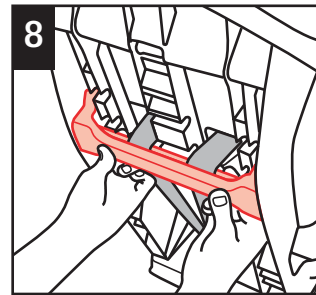

Squeeze the metal bar on the back of the seat. Move harness/headrest adjuster up or down to the position that correctly fits your child. Release bar into slot to lock.

NOTE: The highest position is for belt-positioning use only.

⚠ WARNING:

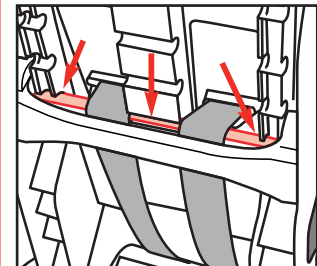

Make sure metal bar is locked into position. Failure to do this can result in serious injury or death.

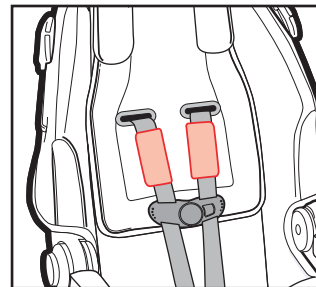

Harness Covers (on select models): Harness covers help provide comfort to the neck. For Harness Covers to fit correctly, you may have to fit the upper ends of the covers through the harness slots. To remove the covers, unthread the harness from harness bracket (see belt-positioning booster section), remove covers, and rethread harness. Reverse to replace insert.

13

Reclining the Child Restraint

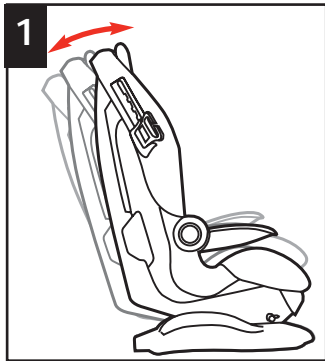

This child restraint has 3 positions: Upright, Semi-reclined, and fully reclined.

Forward-Facing - Reclined, semi-reclined or upright.

Belt-Positioning Booster - Must be fully-upright.

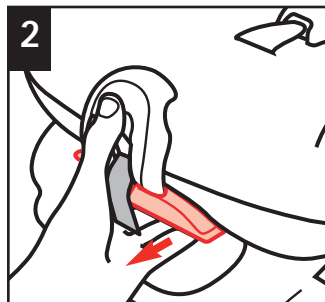

To fully recline, pull out on handle and push top of child restraint back.

For upright position, pull out on handle and pull child restraint up.

Rotating Armrests

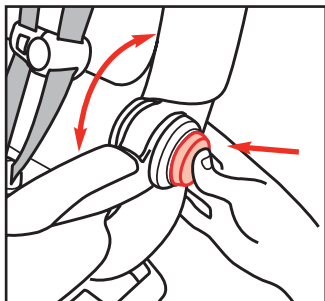

Depending on your model, your child restraint may have a red button which will lock the armrest in either the upright or down position. To rotate locking armrests, push in on red button and rotate. Make sure armrests lock into place.

14

Securing Your Child in the Child Restraint



Position harness straps over the child's shoulders.

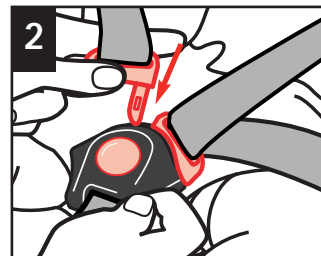

Push each buckle plate into buckle until you hear a "click". Remember to always pull up on harness straps to make sure buckle is locked tightly.

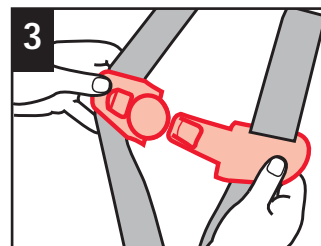

Snap the harness retainer together.

15

continued on next page.

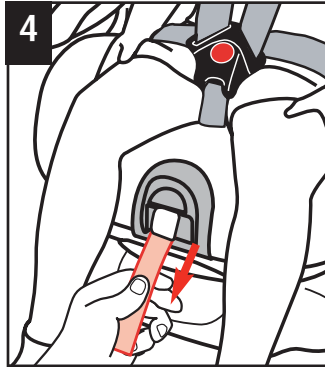

4 Pull on harness adjustment strap to tighten harness snugly.

NOTE: A snug strap should not allow any slack. It lies in a relatively straight line without sagging. It does not press on the child's flesh or push the child's body into an unnatural position.



5 Position the harness retainer at mid-chest (even with arm pits), away from the child's neck.

⚠ WARNING:
Failure to fasten and tighten the harness system correctly with each use can result in serious injury or death.

Removing Your Child From the Child Restraint

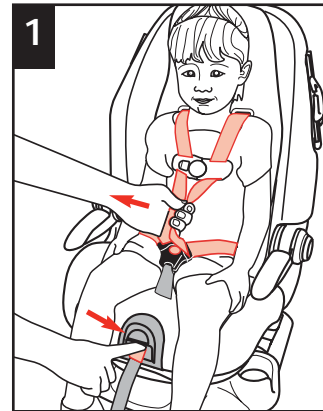

1 Loosen harness by pushing down on the harness release lever while pulling out on the harness.

Depending on your model, the harness release lever may be under a flap on the pad in the front of restraint.

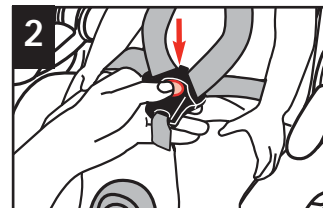
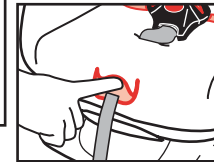

2 Press red button on buckle to release the buckle plates.

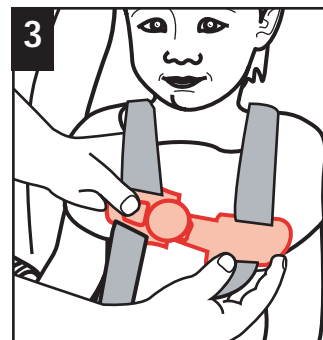

3 Press on release button and pull apart. Place harness over sides of child restraint. Remove child.

Choosing LATCH or Vehicle Belts

The LATCH System

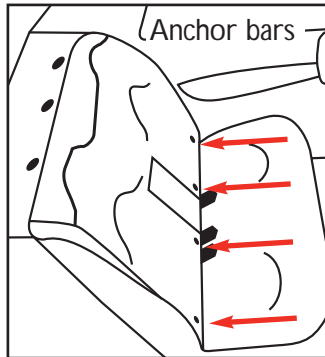

LATCH means **L**ower **A**nchors and **T**ethers for **C**hildren. Not all vehicles manufactured before September 2002 were equipped with LATCH.

The LATCH system allows a child restraint to be secured in the vehicle without using the vehicle belt system and can **ONLY** be used in vehicles that have the anchor bars installed.

Check your vehicle owners manual to see which seating positions may be equipped with the LATCH system.

Vehicle Belts

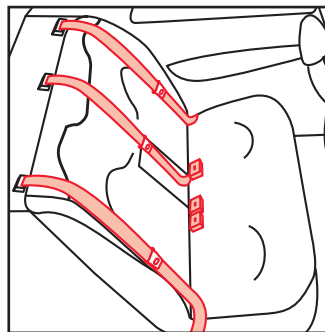

If LATCH is not an option, you will use your vehicle's belts. In most cases you will use the lap/shoulder belt combination. There are some vehicle belts that will not work with a child restraint or require special attention. See next page for specific instructions.

Knowing Your Vehicle Belts

Not all vehicle belts will work with this child restraint. You must determine if your vehicles belts are compatible with this child restraint. If you will use the LATCH system, refer to the LATCH section.

ELR - Emergency Locking Retractor Belts

Definition: These belts only lock in a sudden stop or crash. To see if you have this type of belt, pull on the lap belt, let it return part way, then pull on it again. If it moves freely, it is an ELR belt and the child restraint could work loose during normal driving. Refer to your vehicle owner's manual.

ELR shoulder belts either require a locking clip or cannot be used with any child restraint. **Note:** You may use an ELR lap and shoulder belt when using this child restraint as belt-positioning booster; no locking clip is required.

ELR lap-only belts must be replaced with a manual belt; contact your vehicle dealer. A locking clip will not correct this problem.

Automatic/Passive vehicle seat belts

Automatic (passive) 2-point belt has no lap belt. You must install a lap belt to secure a child restraint. You may also need to install an extra lap belt for an automatic 3-point belt. Refer to the vehicles owner's manual. A locking clip will not correct this problem.

Vehicle belt too short

Contact your vehicle dealer for a seat belt extender.

Belts in center of the door or side panel (A) or middle of the vehicle seat cushion (B).

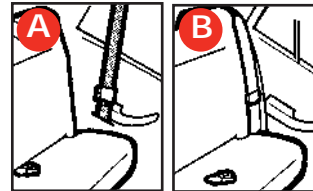

You must move the child restraint to another seating location. A locking clip will not fix this problem.

See "Locking Clip" section.

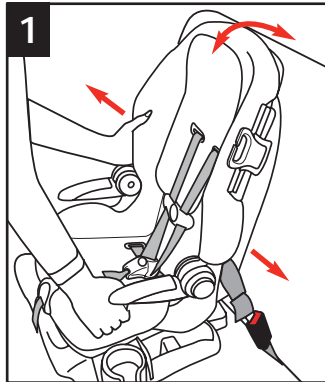

Manual Belts

Manual lap belts are common in the center rear seat and can allow the child restraint to loosen when it is tilted or jarred. After tightening the lap belt securely, tilt and push the child restraint forward and to both sides. If no loosening occurs, your child restraint should be secure.

If loosening does occur, try the following: If the buckle plate slides on the belt, turn the buckle plate over. If the buckle slides, turn the buckle. Refasten the vehicle lap belt. The release button should face **out** after twisting so that it is easy to reach in an emergency.

If the lap belt continues to loosen, the child restraint must be moved to another location in the vehicle. A locking clip will not correct this problem; see your vehicle owner's manual.

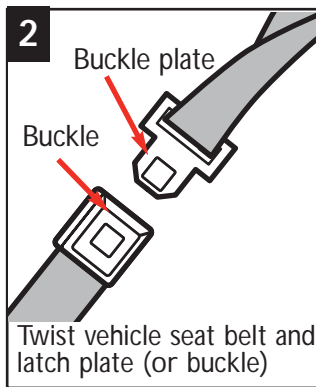

⚠ WARNING

Failure to check and adjust the manual belt as described above can result in serious injury or death.

Locking Clip

NOTE: The locking clip is located on the back of the seat. You do not need a locking clip when using this seat as a belt-positioning booster.

Remove the locking clip when the seat belt is not being used with a child restraint. **A locking clip will not fix all types of seat belt problems.**

Before you put your child restraint in the vehicle, buckle the lap/shoulder belt. Pull on the lap belt portion. If it loosens or slips, you must either use a locking clip to hold the seat belt tight or move the child restraint to another seating location.

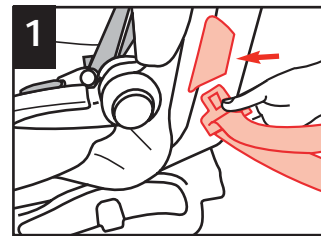

Thread both vehicle lap and shoulder belts through the slot (as shown) and out other side. Buckle. Pull up on shoulder belt until all slack is out and lap belt is tight.

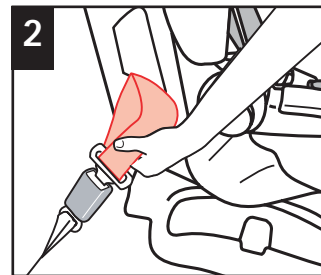

Grasp both vehicle belts together just behind the buckle plate and unbuckle. **NOTE:** If the buckle plate ends up behind the child restraint, grasp the belts to the outside of the child restraint, as close to the buckle plate as possible.

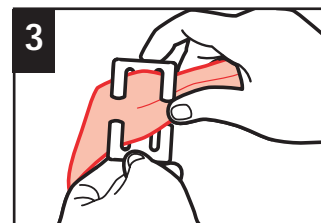

Thread both portions of the vehicle belt onto the locking clip.

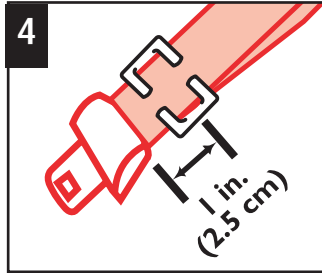

4 Position locking clip about 1 in. (2.5 cm) from vehicle belt's buckle plate.

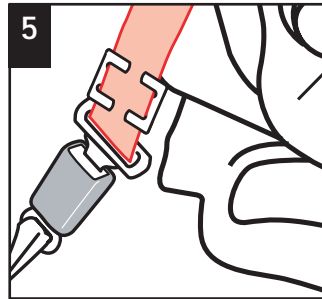

5 Rebuckle belt. Lap belt portion should now be tight. If not, remove locking clip and repeat all steps.

Forward-Facing Use

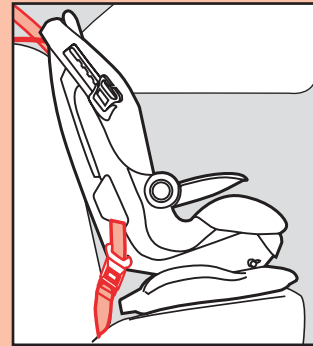

Lap/Shoulder Belt

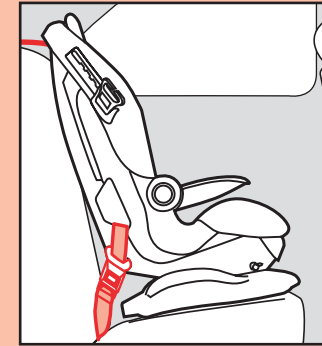

Lap Belt

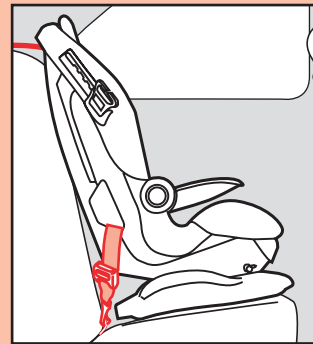

LATCH Belt

Refer to the "Choosing Restraint and Position" section to make sure your child is at the proper weight and height to face forward.

⚠ WARNING:

Using this child restraint in any vehicle seat where the lap or LATCH belts cannot be tightened securely and properly or where it can be loosened by pulling on it can result in serious injury or death.

Check vehicle instructions for more information about air bag/child restraint use.

Forward-Facing Use: 22-40 lbs. (10.1-18 kg), 34-43" (85.1-110 cm), Over 1 year of age.

Forward-Facing Installation

After deciding whether to use your Vehicle Belts or LATCH, be sure to read the warnings below as they pertain to both systems.

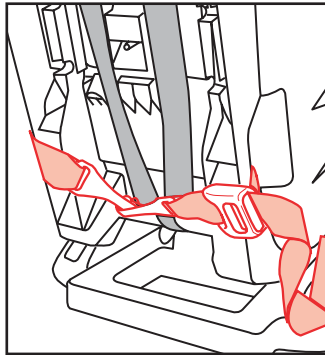

When LATCH is not being used, fasten belt hooks together behind the child restraint as shown.

⚠ WARNING:

Loose LATCH hooks can result in serious injury or death.

Forward-Facing Installation with Vehicle Belts:

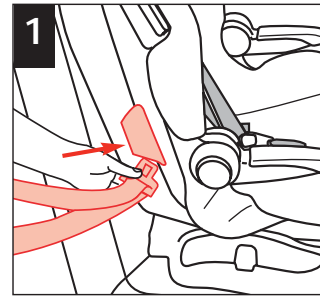

1 Connect and tighten harness straps prior to installing in vehicle.

Place child restraint **flush** against the back of the vehicle seat **forward-facing** in the back seat.

The recline position is to be used only to install the child restraint flush

against the back of the vehicle seat back, if needed.

Thread the vehicle lap belt or lap/shoulder belt combination through the belt path and out other side. Buckle.

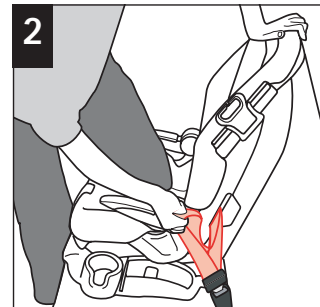

2 Place one knee in the child restraint and push down firmly while pulling up on belt to tighten. For a manual belt, refer to "Knowing your Vehicle Belt" section.

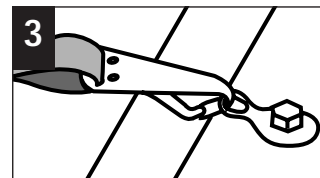

3 With knee still in child restraint, attach hook to anchor in vehicle. Push down firmly and tighten top anchorage strap.

To adjust top anchorage strap: See "Adjusting Top Anchorage Strap" section.

NOTE: If your vehicle does not have an anchor bracket, tuck the top anchorage strap's hook under the child restraint.

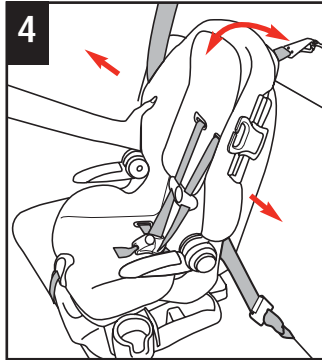

With weakest hand at belt path, tilt and push the child restraint forward and back, and from side to side. If the seat belts do not loosen, your child restraint should be secure.

NOTE: Some "play" from front to back or about an inch from side to side is acceptable. If it moves more, review "Knowing Your Vehicle Belts" and "The Locking Clip" sections.

⚠ WARNING

Using this child restraint in any vehicle seat where the lap belt cannot be tightened securely and properly or where it can be loosened by pulling on it can result in serious injury or death.



After checking for hot seat and buckles, place your child in the child restraint as described in the "Securing Your Child in the Child Restraint" section.

Forward-Facing Installation with LATCH Belt: Install LATCH Belts

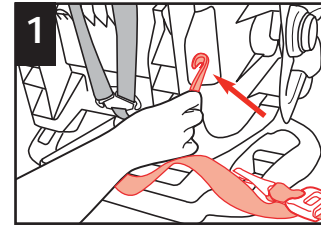

NOTE: Do not use LATCH system along with the adult lap or lap/shoulder belt.

Route LATCH belt through upper slot in side of shell.

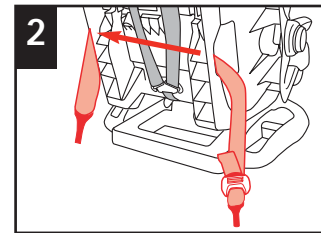

Pull one LATCH hook across the back and out the other side.

The LATCH adjuster can be on either side, but the belt should not be twisted.

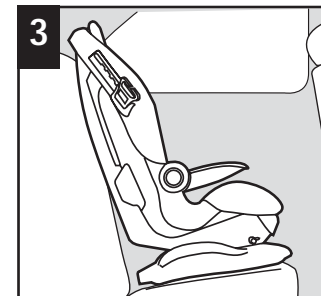

Connect and tighten harness straps prior to installing in vehicle. Place child restraint **flush** against the back of the vehicle seat **forward-facing** in the back seat.

The recline position is to be used only to install the child restraint flush against the back of the vehicle seat back, if needed.

Forward-Facing Use: 22-40 lbs. (10.1-18 kg), 34-43" (85.1-110 cm), Over 1 year of age.

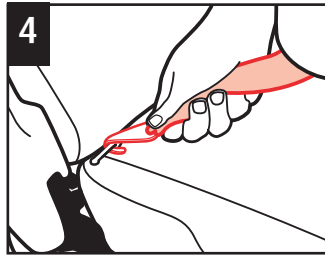

4 Fasten one LATCH belt hook to the anchor in the vehicle seat located in the vehicle seat bight. Repeat for other side of child restraint. See your vehicle owner's manual for locations and more information.

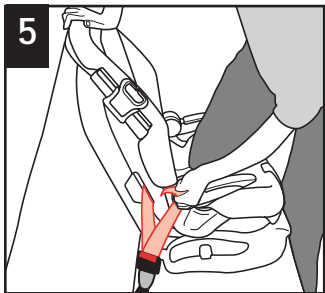

5 Place one knee in the child restraint and push down firmly while pulling up on the loop to tighten belt.

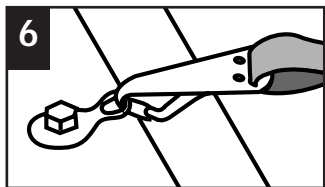

6 With knee still in child restraint, attach hook to anchor in vehicle. Push down firmly and tighten top anchorage strap.

To adjust top anchorage strap: See "Adjusting Top Anchorage Strap" section.

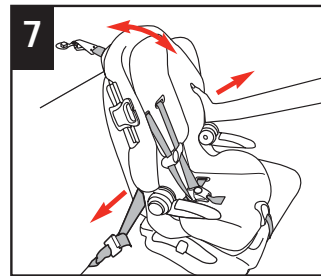

7 With weakest hand at belt path, tilt and push the child restraint forward and back, and from side to side. If the LATCH belts do not loosen, your child restraint should be secure.

NOTE: Some "play" from front to back or about an inch from side to side is acceptable.

If the child restraint does not remain tight, do not use the child restraint in this seating location with this LATCH system.

⚠ WARNING

LATCH hooks MUST be securely fastened. Failure to do this can result in serious injury or death.

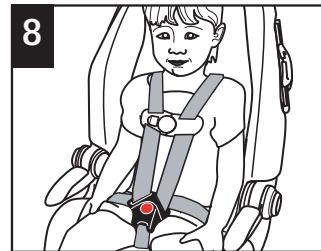

8 After checking for hot seat and buckles, place your child in the child restraint as described in the "Securing Your Child in the Child Restraint" section.

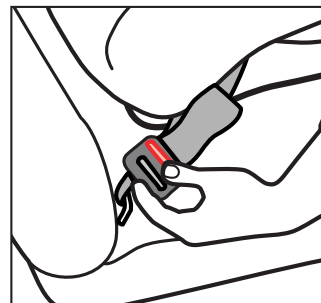

To release LATCH: Remove child from child restraint. Press down firmly on adjuster side of child restraint and press release button to release tension. Unhook LATCH from bar by squeezing spring lever and twist hook off bar.

Forward-Facing Use: 22-40 lbs. (10.1-18 kg), 34-43" (85.1-110 cm), Over 1 year of age.

Adjusting the Top Anchorage Strap

The top anchorage strap is used for the forward-facing position only.

Most vehicles made after 9/1/99 already have the anchor hardware for a top anchorage strap. Refer to your owner's manual or call your dealer.

Storage of Top Anchorage Strap:

Belt-Positioning Booster position: Place top anchorage strap and anchor hook under the child restraint.

Review the 3 styles of top anchorage straps below and the next 2 pages to determine which style you have. Review label on top anchorage strap to verify your adjustment method.

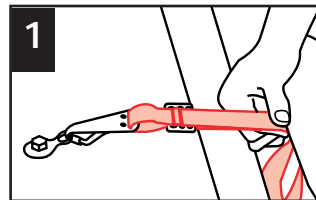

Style 1 - To Attach Top Anchorage Strap: Put knee in child restraint and push down; attach hook to anchor in vehicle to estimate how much adjustment you need, then unhook.

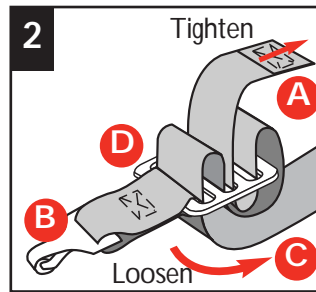

To Adjust Top Anchorage Strap: Loosen top anchorage strap into "loops" at adjuster slide as shown above.

To tighten top anchorage strap: Pull on free end (A) of top anchorage strap while holding hook (B).

To loosen top anchorage strap: Pull on lower top anchorage strap (C) while holding

adjusting slide (D) with your other hand.

Pull on free end of top anchorage strap until the "loops" are flush against the adjuster. Reattach hook to anchor to check fit, repeat steps if needed.

⚠ WARNING

You must follow the threading diagram exactly. Failure to follow these steps could cause the strap to loosen in a crash, which can result in serious injury or death.

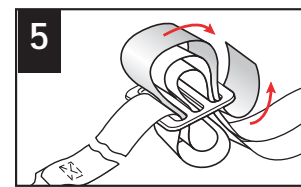
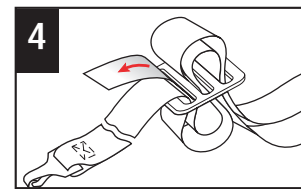
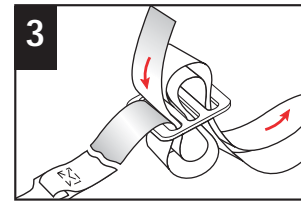
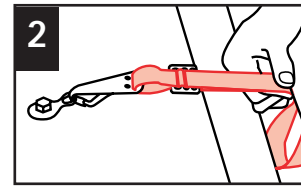
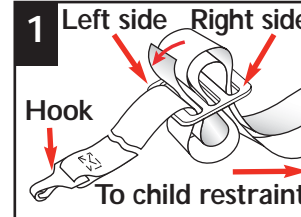

Style 2 - To Attach Top Anchorage Strap: At the adjuster, unlace free end of strap from right side of adjuster slide and loosen into "loops" (1). Put knee in child restraint and push down; attach hook to anchor to estimate how much you need, then unhook (2).

To loosen top anchorage strap: With adjuster in hand, pull the top strap (3) between adjuster and child restraint to desired length. Attach hook to anchor, check fit, repeat steps if necessary. **You must rethread the free end of strap back down through the right slot (5) or the tether will not hold.**

Tighten strap so "loops" are gone and there is no slack or play.

To tighten tether: With adjuster in hand, pull the top strap (4) between adjuster and hook to the desired length. Attach hook to anchor, check fit, repeat steps if necessary. **You must rethread the free end of strap back down through the right slot (5) or the tether will not hold.**

Tighten strap so "loops" are gone and there is no slack or play.

⚠ WARNING

You must follow the threading diagram exactly. Failure to follow these steps could cause the strap to loosen in a crash, which can result in serious injury or death.

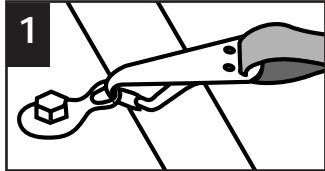

1 **Style 3 - To Attach Top Anchorage Strap:**
Put knee in child restraint and push down; attach hook to anchor in vehicle.

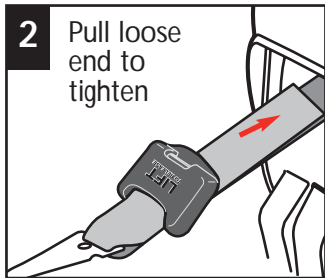

2 Pull loose end to tighten

To Adjust Top Anchorage Strap:
To tighten; pull on free end of top anchorage strap.

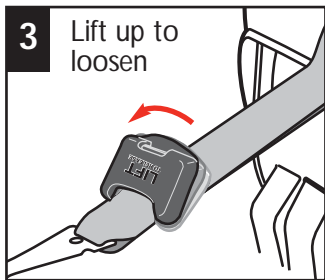

3 Lift up to loosen

To loosen; lift up on top anchorage lock and push lock toward top anchorage hook.

⚠ WARNING

You must follow the threading diagram exactly. Failure to follow these steps could cause the strap to loosen in a crash, which can result in serious injury or death.

Belt-Positioning Booster Use

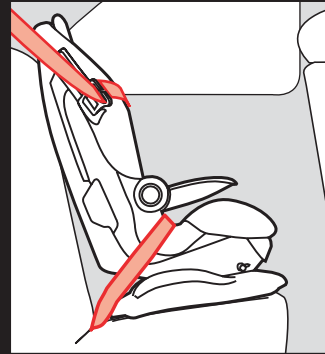

Lap/Shoulder Belt

Refer to the "Choosing Restraint and Position" section to make sure your child is at the proper weight and height to use the belt-positioning booster.

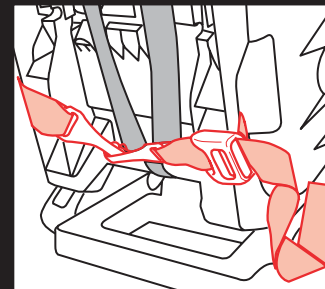

Do not use LATCH when using the Belt-Positioning Booster.

You **MUST** fasten the LATCH belt hooks together behind seat.

When your child is over 40 lbs. (18.1 kg) or 43" (110.1 cm) and over 1 year old, you must use this seat as a belt-positioning booster.

⚠ WARNING

Loose LATCH hooks can result in serious injury or death.

Belt-Positioning Booster Use: 40-100 lbs. (18.1-45.4 kg), 43-52" (110.1-132.1 cm). Over 1 year of age.

Removal of Harness

Harness must be removed for use as a Belt-Positioning Booster.

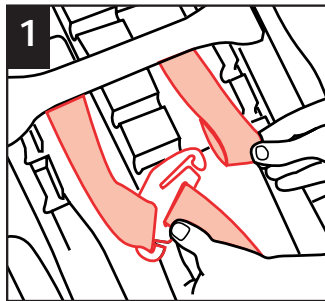

1 From the back of the seat, unfasten harness from splitter plate.

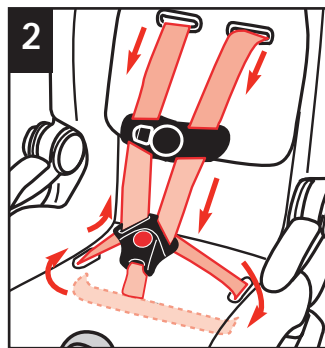

2 Pull harness through the slots from the front.
Unthread harness from the harness retainer.
Unthread harness from the buckle plates.
Pull harness out of shell.

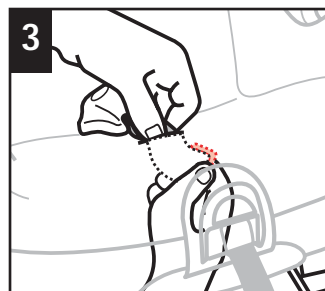

3 With seat reclined all the way back, reach under seat between base and shell and locate buckle's metal clip. It will be flush against the shell.

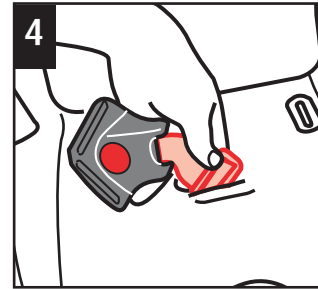

4 Rotate metal clip, then insert up through the shell and pad. From the front, pull buckle free from shell and pad. Lock buckle plates into buckle for future use.

Belt-Positioning Booster Use: 40-100 lbs. (18.1-45.4 kg), 43-52" (110.1-132.1 cm) Over 1 year of age.

Belt-Positioning Booster Installation



1 Child restraint must be in the full upright position. Pull out on recline handle and pull child restraint all the way up. Place booster seat against the back of the vehicle seat. Tuck the top anchorage hook and splitter plate under the base. Have child sit in seat with his back and bottom fully in the seat.

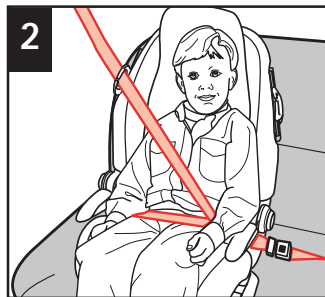

2 Place BOTH shoulder and lap belt across child's thighs. Lock buckle. **NOTE:** Make sure the lap and shoulder belt are placed under armrest as shown.

⚠ WARNING
Use only the vehicle's lap and shoulder belt system when restraining the child in this booster seat. Failure to do this can result in serious injury or death.

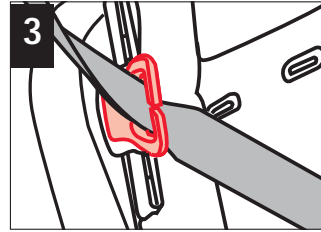

3 Secure the vehicle shoulder belt through the notch in the shoulder belt guide. The belt should cross the base of the child's neck and across the chest (not the face or neck). Pull up on the vehicle shoulder belt to tighten.

Secure the vehicle shoulder belt through the notch in the shoulder belt guide. The belt should cross the base of the child's neck and across the chest (not the face or neck). Pull up on the vehicle shoulder belt to tighten.

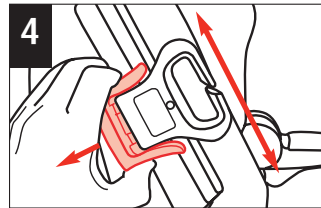

4 Check periodically to ensure your child has not moved out of position and loosened the vehicle shoulder belt.

To adjust shoulder belt guide, pull down on red end and slide guide up and down track. Make sure the belt guide locks into place.

⚠ WARNING
Check vehicle instructions for more information about air bag/child restraint use. **Do Not Use** only the lap belt when using this seat as a belt-positioning booster without the internal harness. The shoulder belt must always be adjusted snugly across the child's chest. **NEVER** place the shoulder belt under the child's arms. Use only the vehicle's lap and shoulder belt system when restraining the child in this booster seat. Failure to follow these warnings can result in serious injury or death to your child.



Belt-Positioning Booster Use: 40-100 lbs. (18.1-45.4 kg), 43-52" (110.1-132.1 cm) Over 1 year of age.

Reinstall Harness

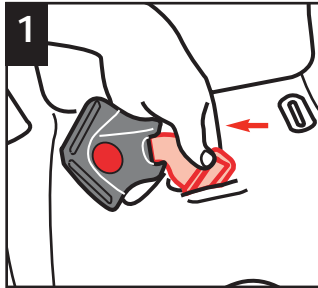

Reinstall Harness:

Fit the buckle strap down through the slot in the seat. Make sure buckle faces out.

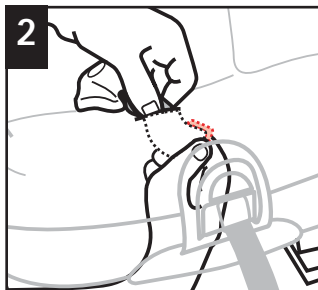

With seat reclined all the way back, reach under seat between base and shell and pull buckle clip through pad and shell. Make sure buckle clip is flush against bottom of shell.

⚠ WARNING:

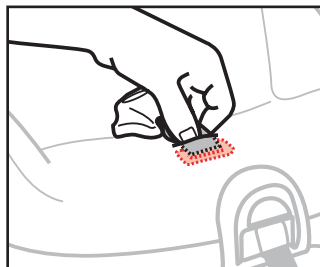

Failure to place buckle's metal plate completely through pad and shell can result in serious injury or death to the child.

38

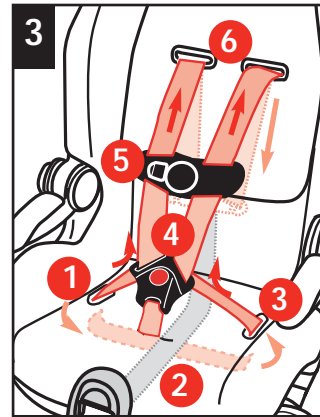

Thread one end of harness down through slot on left side of shell (1), across bottom of seat (2) and up through slot on right side (3).

Thread one buckle plate onto harness from back to front (4). Thread the harness retainer (5). Do the same to the other harness end. Make sure the harness is not twisted.

Push harness ends through upper slots in shell (6).

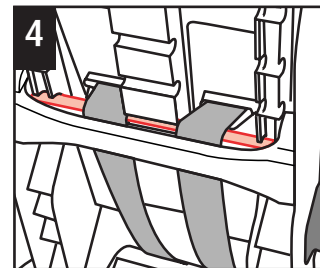

Pull harness through the back. Make sure the harness goes OVER the metal bar, BETWEEN metal bar and plastic handle of the harness/headrest adjuster.

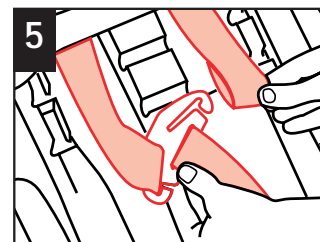

Fit loops on harness ends onto the splitter plate.

⚠ WARNING

Failure to reattach the buckle and harness correctly, can result in serious injury or death.

39

Removing Seat Pad for Cleaning

⚠ WARNING

Do not use this child restraint without the seat pad. Failure to do this can result in serious injury.

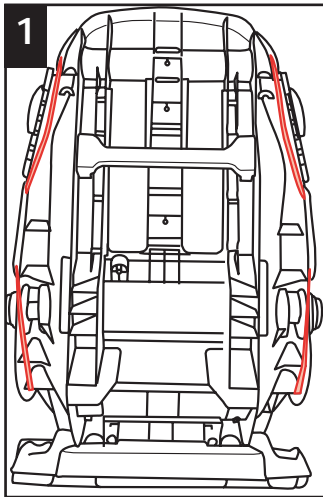

1 From back of shell, release the elastic straps shown in red.

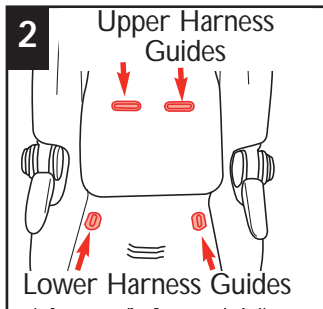

2 Adjust backrest to lowest position. Locate harness guides.

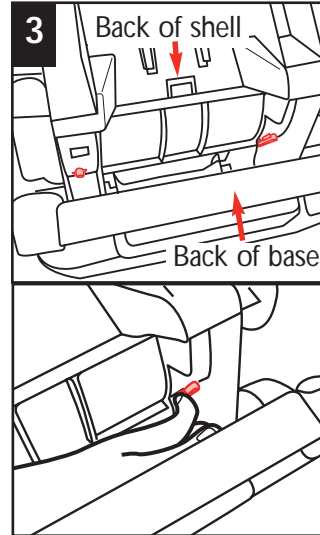

3 Remove both lower harness guides in bottom of seat by reaching between the base and shell from the back.

Push harness guide lip toward outside of shell with one hand while pulling harness guide from the front with the other.

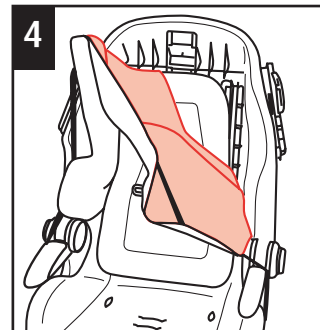

4 From the top, pull pad off shell and over headrest.

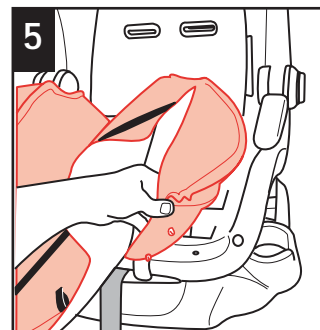

5 At the bottom, unsnap pad off shell at one corner, working pad out from harness adjustment cover and unsnap other side. Remove pad from shell.

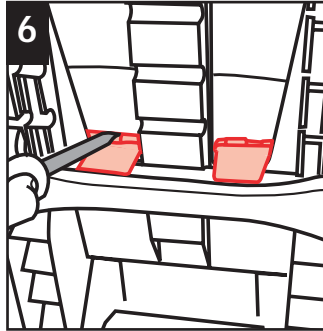

6 From the back, use a screwdriver to press in on lip of upper harness guides and pop guides through the front. Pull cover off headrest.

Hand wash with warm sudsy water, rinse clean and air dry. Do not use bleach or use other harsh cleaners. Do not dry clean.

Spot clean harness straps. Do not machine wash.

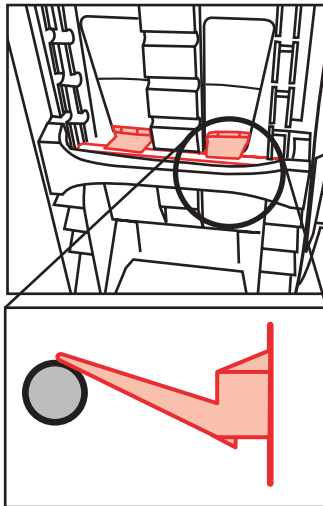

Replace seat pad by reversing order:

Put pad on headrest and replace harness guides. **Make sure harness guides tabs go over metal bar.**

Starting from bottom of child restraint, snap pad on shell; tuck in pad around harness adjuster; pull pad up and over headrest. Attach the elastic straps. Make sure pad is under headrest and replace lower harness guides. Rethread harness (see belt-positioning booster section).

Troubleshooting

✓1. If your child restraint is not held securely by the belt:

Press down firmly on the child restraint and remove all the slack in the belt. Make sure the belt buckle is not up against the child restraint where the belt cannot be tightened. Review Locking Clip section and Top Anchorage Strap Section. If you cannot secure the child restraint tightly, move it to another seating location.

✓2. If the child restraint buckle or harness release lever sticks or you cannot get the straps tight enough around child:

DO NOT LUBRICATE. Check around buckle and harness release lever for dropped food, sticky spilled drinks, dirt, leaves, etc. Clean with warm water and/or remove object with tweezers. If you cannot get the harness to adjust and remain tight with the buckle securely locked, do not use the child restraint.

✓3. If your harness twists or ropes:

Straighten the harness each time you put your child in the seat to help prevent twisting. Lock the buckle and tighten harness and it will be ready for next use.

Installation Tips:

When using the internal harness, the harness must be positioned at or above the child's shoulders.

When using the internal harness, make sure the vehicle lap belt is locked. When you grasp the the child restraint at the belt path, it should not move more than about an inch side to side.

Warranty

Dorel Juvenile Group, Inc. (DJG) warrants this product to the original retail purchaser as follows:

This product is warranted against defective materials or workmanship for one year from the date of original purchase.

An original receipt is required to validate your warranty. DJG will, at its option, provide replacement parts or replace this product. DJG reserves the right to substitute if the part or model has been discontinued.

To make a claim under this warranty you may contact us at www.djgusa.com, fax us at 1-800-207-8182 24 hours a day, write to DJG, Consumer Relations Department, P. O. Box 2609, Columbus, IN 47202-2609, or call 1-800-544-1108 from 7:00 a.m. to 6:00 p.m. EST Monday through Thursday and from 7:00 a.m. to 4:30 p.m. on Friday. **Proof of purchase is required and shipping charges are the responsibility of the consumer.**

Warranty Limitations:

This warranty does not include damages which arise from misuse or abuse of this product.

Limitation of Damages:

The warranty and remedies as set forth are exclusive and in lieu of all others, oral or written, expressed or implied. In no event will DJG or the dealer selling this product be liable to you for any damages, including incidental or consequential damages, arising out of the use or inability to use this product.

Limitation of warranties and other warranty terms and state law rights:

Any implied warranties, including implied warranties of the merchantability and fitness for a particular purpose, shall be limited to the duration and terms of the express written warranty. Some states do not allow limitations as to how long an implied warranty lasts or the exclusion or limitation of incidental or consequential damages, so the above limitations may not apply to you. This warranty gives you specific legal rights, and you may have other rights, which vary from state to state. Neither DJG nor the dealer selling this product authorized any person to create for it any other warranty, obligation, or liability in connection with this product.

PLEASE COMPLETE AND MAIL THE PRE-ADDRESSED OWNER REGISTRATION CARD WITHIN (30) DAYS OF PURCHASE TO EXPEDITE WARRANTY CLAIMS AND TO VERIFY THE ORIGINAL DATE OF PURCHASE.

Replacement Parts Order Form

Complete the form below. Your model number with color code and manufacturer date code **MUST** be included on the form to ensure proper replacement parts. Your model number with color code and the date code can be found on a sticker on the side of child restraint. Payment in U.S. dollars must accompany your order. Choose parts needed from the list on the next page.

Return the form with payment to:

Dorel Juvenile Group, Inc.
Consumer Relations Department
P.O. Box 2609
Columbus, IN 47202-2609

Fax orders to: 1-800-207-8182

Please make money orders payable to Dorel Juvenile Group, Inc. Fill in the area below to charge to Visa or Mastercard. We do not accept personal checks or Discover Card. All outside of U.S. and Canada **MUST** use credit card.

Ship To (Please Print): _____

Name: _____

Address: _____

City: _____

State/Province: _____ Zip _____

Telephone: _____

Email Address: _____

We **MUST have this information to process your order:**

Model Number (5 digits & 3 letters): _____

Manufacture Date (mm/dd/yyyy): _____

Free Manuals Download Website

<http://myh66.com>

<http://usermanuals.us>

<http://www.somanuals.com>

<http://www.4manuals.cc>

<http://www.manual-lib.com>

<http://www.404manual.com>

<http://www.luxmanual.com>

<http://aubethermostatmanual.com>

Golf course search by state

<http://golfingnear.com>

Email search by domain

<http://emailbydomain.com>

Auto manuals search

<http://auto.somanuals.com>

TV manuals search

<http://tv.somanuals.com>