

Sunbeam

Open All™ Electric Can Opener

Instruction Booklet
CA2800

Please read these instructions carefully
and retain for future reference.



Contents

Sunbeam's Safety Precautions	1
Safety Precautions for your Open All	1
Features of your Open All	2
Using your Sunbeam Open All	4
Care and Cleaning of your Open All	6

Important instructions – retain for future use.

تأكد من تفهم احتياطات السلامة المذكورة اعلاه

請務必理解上述的安全預防措施。

Assurez-vous que les précautions ci-dessus relatives à la sécurité sont bien comprises

Versichern Sie sich, dass die obenstehenden Sicherheitsmaßnahmen verstanden werden

Βεβαιώστε πως οι παραπάνω προφυλάξεις ασφαλείας γίνονται κατανοητές

Pastikan bahwa tindakan-tindakan keselamatan seperti di atas dimengerti anda

Accertatevi che le suddette norme di sicurezza siano comprese a dovere

上記の注意事項をよくお読みになり、安全を御確認ください

Уверете се дека погоре споменатите мерки на претпазливост се добро разбрани

Asegúrese de que las precauciones de seguridad precedentes sean bien comprendidas

کاری بکنید کہ احتیاط‌های بالا حتماً درک بشوند

ต้องแน่ใจว่า ข้อควรระวังเรื่องความปลอดภัยข้างต้น เป็นที่เข้าใจกันดี

Yukarda belirtilen güvenlik önlemlerinin anlaşılığından emin olunuz

Xin kiểm chắc rằng những biện pháp làm an toàn kể trên được hiểu rõ

Sunbeam's Safety Precautions

SAFETY PRECAUTIONS FOR YOUR SUNBEAM OPEN ALL.

- Keep fingers well away from blade when in use.
- Use extreme care when handling blades.
- Do not place any part of this appliance in a dishwasher.
- Use extreme care when handling off-cuts.

Sunbeam is very safety conscious when designing and manufacturing consumer products, but it is essential that the product user also exercise care when using an electrical appliance. Listed below are precautions which are essential for the safe use of an electrical appliance:

- Read carefully and save all the instructions provided with an appliance.
- Always turn the power off at the power outlet before you insert or remove a plug. Remove by grasping the plug - do not pull on the cord.
- Turn the power off and remove the plug when the appliance is not in use and before cleaning.
- Do not use your appliance with an extension cord unless this cord has been checked and tested by a qualified technician or service person.
- Always use your appliance from a power outlet of the voltage (A.C. only) marked on the appliance.
- This appliance is not intended for use by persons (including children) with reduced physical, sensory or mental capabilities, or lack of experience and knowledge, unless they have been given supervision or instruction concerning use of the appliance by a person responsible for their safety.
- Children should be supervised to ensure that they do not play with the appliance.
- The temperature of accessible surfaces may be high when the appliance is operating.
- Never leave an appliance unattended while in use.
- Do not use an appliance for any purpose other than its intended use.
- Do not place an appliance on or near a hot gas flame, electric element or on a heated oven.
- Do not place on top of any other appliance.
- Do not let the power cord of an appliance hang over the edge of a table or bench top or touch any hot surface.
- Do not operate any electrical appliance with a damaged cord or after the appliance has been damaged in any manner. If damage is suspected, return the appliance to the nearest Sunbeam Appointed Service Centre for examination, repair or adjustment.
- For additional protection, Sunbeam recommend the use of a residual current device (RCD) with a tripping current not exceeding 30mA in the electrical circuit supplying power to your appliances.
- Do not immerse the appliance in water or any other liquid unless recommended.
- Appliances are not intended to be operated by means of an external timer or separate remote control system.
- This appliance is intended to be used in household and similar applications such as: staff kitchen areas in shops, offices and other working environments; farm houses; by clients in hotels, motels and other residential type environments; bed and breakfast type environments.

If you have any concerns regarding the performance and use of your appliance, please visit www.sunbeam.com.au or contact the Sunbeam Consumer Service Line.

Ensure the above safety precautions are understood.

Features of your Open All

Release Button

Cutting Assembly

Support Bar

Drive Wheel

Knife Sharpener

Built in ceramic knife sharpener will ensure that your knives remain sharp at all times.

Cord Storage

Handy cord storage keeps the benchtop tidy by storing unwanted cord.

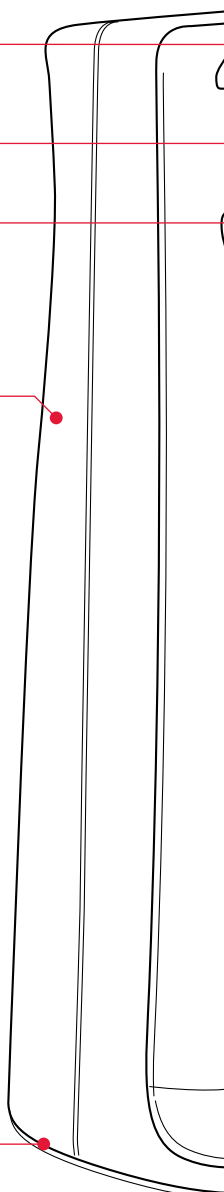

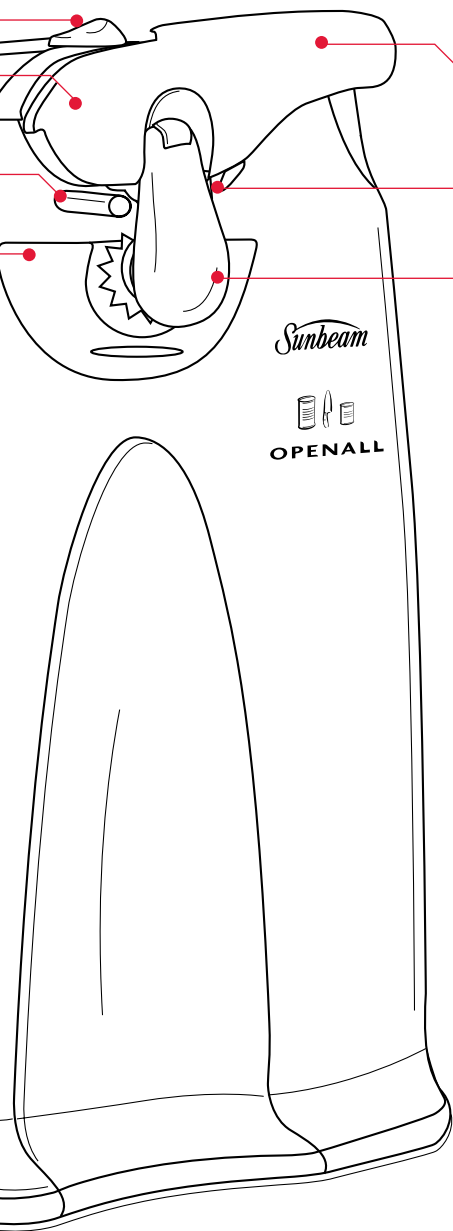

Lever

Blade

Magnetic Lid Holder

Stainless steel blade cutting action

Stainless steel blade allows for a smoother cutting action.

Magnetic lid holder

Holds the lid in place during and after the can is fully opened.

Removable lever

For easy cleaning, slide the release button and remove the cutting assembly/lever.

Automatic operation

Simply lift the lever and position the blade inside the rim of the can. Press the lever down and the Open All™ can opener will automatically stop when the can is fully opened.

Using your Sunbeam Open All

1. Ensure that the Cutting Assembly is correctly positioned. (See figure 1.)

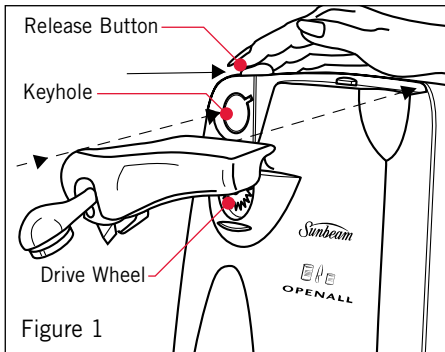

Figure 1

The Cutting Assembly fits into the keyhole opening at the top of the Open All™ can opener, above the Drive Wheel. Slide the Release Button to the right as the Cutting Assembly is inserted, it will “click” into position, with the release button returning to its original position.

2. Insert the plug into a 230-240 volt power outlet and turn the power on.
3. Hold the Lever in the upright position. Position the can under the Support Bar so that the rim of the can rests on top of the Drive Wheel, tilting the can at a slight angle towards the main body of the unit. (See figure 2.)

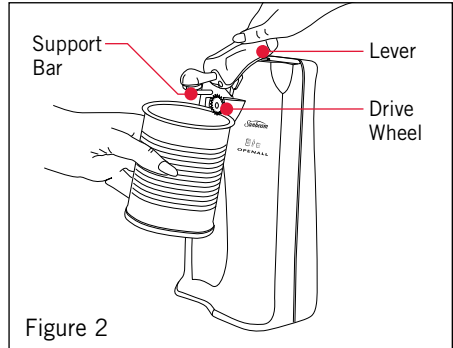

Figure 2

4. Firmly press the Lever down. This action will bring the blade down and pierce the lid of the can and start operating the motor to turn the can. Ensure the Magnetic Lid Holder is in contact with the lid of the can. (See figure 3.)

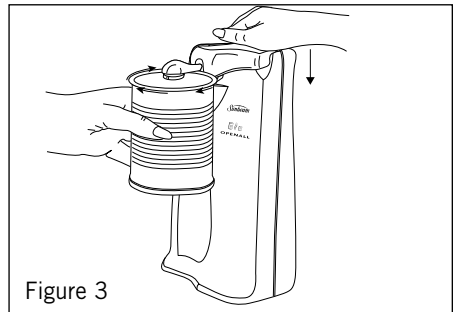

Figure 3

5. When the can begins to turn, it is no longer necessary to hold down the Lever.
6. When the can is fully opened, the Open All™ can opener will stop automatically.

7. To remove the can, support the can with one hand and lift the Lever with the other. The lid will remain attached to the Magnetic Lid Holder. (See figure 4.)

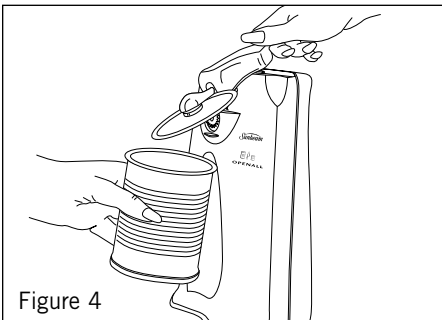

Figure 4

CAUTION: Be careful when removing the lid from the magnet as the cut edge is sharp.

Opening dented/damaged cans:

Occasionally, badly dented cans will cause the Open All™ can opener to stall. If this happens, grasp the dented can and guide it through the cutting action manually until the damaged areas are opened.

Jammed cans: To continue opening a can that has become jammed, raise the Lever and release the can. Begin the cutting action again in a new position on the can lip.

Sharpening knives: Support the Open All™ can opener on top with one hand. With the other guide the knife through the unique ceramic block at the back of the Open All™ can opener. Repeat this action until you are satisfied with the sharpness of your knife.

Care and Cleaning

Turn the power off and unplug the cord from the power outlet before cleaning. The Cutting Assembly is easily removed for thorough cleaning. (See figure 5.)

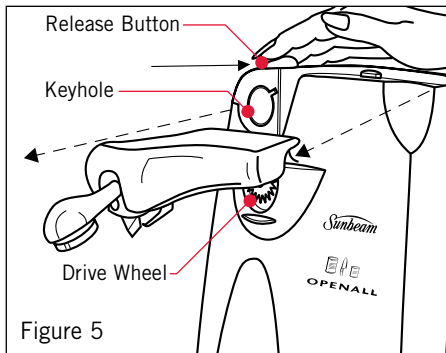

Figure 5

Removing the Cutting Assembly:

Raise the Cutting Assembly to its most upright position. Slide the Release Button to the right and slide out the Cutting Assembly. To replace the Lever hold it vertically with the Release Button slid to the right, gently slide it into the Keyhole and rotate clockwise. (See figure 5.)

Drive Wheel:

Wipe with a damp cloth to thoroughly clean, use a small brush to remove accumulated dirt.

Motor Housing:

Wipe over with a damp cloth.

Do not use harsh abrasives or cleaners to clean any parts of your Open All™ can opener, as these may scratch the parts.

Do not wash any parts in an automatic dishwasher, as the hot water temperatures and harsh detergents may ultimately warp and scratch these parts.

Warning: NEVER IMMERSE THE OPEN ALL IN WATER OR ANY OTHER LIQUID.

Notes

Notes

12 Month Replacement Guarantee

In the unlikely event that this appliance develops any malfunction within 12 months of purchase (3 months commercial use) due to faulty materials or manufacture, we will replace it for you free of charge.

Should you experience any difficulties with your appliance, please phone our customer service line for advice on 1300 881 861 in Australia, or 0800 786 232 in New Zealand. Alternatively, you can send a written claim to Sunbeam at the address listed below. On receipt of your claim, Sunbeam will seek to resolve your difficulties or, if the appliance is defective, advise you on how to obtain a replacement or refund.

Your Sunbeam 12 Month Replacement Guarantee naturally does not cover misuse or negligent handling and normal wear and tear.

Similarly your 12 Month Replacement Guarantee does not cover freight or any other costs incurred in making a claim. Please retain your receipt as proof of purchase.

The benefits given to you by this guarantee are in addition to your other rights and remedies under any laws which relate to the appliance.

Our goods come with guarantees that cannot be excluded under the Australian Consumer Law and under the New Zealand Consumer Guarantees Act.

In Australia you are entitled to a replacement or refund for a major failure and for compensation for any other reasonably foreseeable loss or damage. You are also entitled to have the goods repaired or replaced if the goods fail to be of acceptable quality and the failure does not amount to a major failure.

Should your appliance require repair or service after the guarantee period, contact your nearest Sunbeam service centre.

For a complete list of Sunbeam's authorised service centres visit our website or call:

Australia

www.sunbeam.com.au

1300 881 861

Units 5 & 6, 13 Lord Street
Botany NSW 2019 Australia

New Zealand

www.sunbeam.co.nz

0800 786 232

26 Vestey Drive, Mt Wellington
Auckland, New Zealand

Need help with your appliance?

Contact our customer service team or visit our website for information and tips on getting the most from your appliance.

In Australia

Visit www.sunbeam.com.au

Or call 1300 881 861

In New Zealand

Visit www.sunbeam.co.nz

Or call 0800 786 232

 is a registered trademark.

'Open All' is a trademark of Sunbeam Corporation.

Made in China.

Due to minor changes in design or otherwise, the product may differ from the one shown in this leaflet.

© Copyright. Sunbeam Corporation Limited 2011.

ABN 45 000 006 771

Units 5 & 6, 13 Lord Street
Botany NSW 2019 Australia

Unit 3, Building D
26 Vestey Drive
Mt Wellington Auckland
New Zealand

Sunbeam Corporation is a division of GUD Holdings Ltd.

Free Manuals Download Website

<http://myh66.com>

<http://usermanuals.us>

<http://www.somanuals.com>

<http://www.4manuals.cc>

<http://www.manual-lib.com>

<http://www.404manual.com>

<http://www.luxmanual.com>

<http://aubethermostatmanual.com>

Golf course search by state

<http://golfingnear.com>

Email search by domain

<http://emailbydomain.com>

Auto manuals search

<http://auto.somanuals.com>

TV manuals search

<http://tv.somanuals.com>