



# ELITE SERIES

CONSTANCE™ | VICTORIA™

## OWNER'S MANUAL

6530-512X REV. A

**Sundance® Spas**

# Attention New Spa Owner!

Congratulations on the purchase of your new Sundance® spa! The following is a list of automated functions and maintenance recommendations for your new spa. Automated functions have been listed below in an attempt to suppress any operational concerns you may have during startup and the first 24-hours of ownership! Maintenance recommendations are listed in an attempt to stress their importance in protecting your new spa.

## Automated Operations

Approximately two minutes after power is applied to the spa, the first filtration/heating cycle turns on pump 1 (Section 9.0, page 28). An automatic five minute “blow-out” function also activates pump 2 for a period of five minutes to flush all lines. Then, after five minutes, pump 2 turns off and pump 1 continues to operate for the duration of the cycle.

**Note:** This function only occurs during the first filtration/heating cycle each day.

## Maintain Healthy Spa Water

Always maintain your hot tub's water chemistry within the following parameters as defined by the Association of Pool and Spa Professionals/USA:

<b>pH</b>	<b>7.4-7.6</b>
<b>Free chlorine</b>	<b>3.0-4.0 ppm</b>
<b>Free bromine</b>	<b>2.0-4.0 ppm</b>
<b>Total Alkalinity</b>	<b>100-120 ppm</b>
<b>Calcium Hardness</b>	<b>150-250 ppm</b>



**TO DECREASE RISK OF INFECTION OR DISEASE!** Always maintain your spa filter as outlined below to ensure healthy spa water. Refer to pages 35-36 for additional information.

## Required Filter Maintenance

Your new hot tub is equipped with an advanced 2-stage MicroClean™ water filtration system that provides unsurpassed water quality! To ensure maximum water quality at all times, you should clean and reuse the larger pleated filter cartridge every month and replace (throw away) the smaller MicroClean filter cartridge every 3 months, or earlier as necessary. The smaller MicroClean filter cartridge is designed to be thrown away! Attempts to reuse this filter cartridge may result in the re-release of unwanted particles back into the spa. See pages 35-36 for detailed filter cartridge replacement instructions.

## Required Water Maintenance



**TO DECREASE RISK OF INFECTION OR DISEASE!** You should replace the spa's water every 3 months. The frequency depends on a number of variables including frequency of use, number of users, and attention paid to water quality maintenance. You will know it is time for a change when you cannot control sudsing and/or you can no longer get the normal feel or sparkle to the water, even though the key water balance measurements are all within the proper parameters. See pages 42-43 for additional information.

## Table of Contents

<b>1.0</b>	<b>Important Spa Owner Information.....</b>	<b>1</b>
<b>2.0</b>	<b>FCC Notice.....</b>	<b>1</b>
<b>3.0</b>	<b>Important Safety Instructions for all Spa Owners .....</b>	<b>2</b>
3.1	Entrapment Risk .....	6
3.2	Hyperthermia .....	7
3.3	Important Additional CSA Safety Instructions (Canada Only).....	8
3.4	General Electrical Safety Instructions .....	8
<b>4.0</b>	<b>Choosing A Location .....</b>	<b>9</b>
4.1	Outdoor Location .....	9
4.2	Indoor Location .....	10
<b>5.0</b>	<b>Power Requirements .....</b>	<b>11</b>
5.1	North American 60 Hz Power Options .....	12
5.2	Export 50 Hz Power Options.....	12
<b>6.0</b>	<b>Electrical Wiring Instructions .....</b>	<b>13</b>
<b>7.0</b>	<b>Spa Fill Up Procedure.....</b>	<b>15</b>
<b>8.0</b>	<b>Control Functions .....</b>	<b>21</b>
8.1	Control Panel .....	21
8.2	Victoria Spa Features .....	22
8.3	Victoria Air Controls Diagram.....	23
8.4	Victoria Massage/Waterfall Selector Diagram.....	24
8.5	Constance Spa Features .....	25
8.6	Constance Air Controls Diagram.....	26
8.7	Constance Massage/Waterfall Selector Diagram .....	27
<b>9.0</b>	<b>Operating Instructions .....</b>	<b>28</b>
9.1	Setting Water Temperature .....	28
9.2	Activate Jets Pumps .....	29
9.3	Selecting Desired Massage Action .....	29
9.4	Air Controls .....	29
9.5	Multi-Colored LED Light Operation .....	29
9.6	Exterior Lights .....	30
9.7	Adjusting Fluidix Nex, Intelli-Jets, Reflex and ST Jets.....	31
9.8	Waterfall Operation .....	31
9.9	Optional Audio System.....	31
<b>10.0</b>	<b>Automatic Filtration Cycles .....</b>	<b>32</b>
10.1	Standard Filtration/Heating Modes (F0-F3) .....	32
10.2	Economy Filtration/Heating Modes (F4-F6).....	32
10.3	Lock Modes (L1-L2).....	32
10.4	Selecting The Filtration/Heating Mode.....	33

<b>11.0</b>	<b>Spa Maintenance.....</b>	<b>35</b>
11.1	Cleaning The Filter.....	35
11.2	Draining And Refilling.....	37
11.3	Pillow Care.....	38
11.4	Cleaning The Spa Interior.....	39
11.5	Maintaining the Cover.....	39
11.6	Maintaining The Synthetic Cabinet.....	40
11.7	Winterizing.....	40
11.8	Restarting Your Spa in Cold Weather.....	41
11.9	Top Rail Care And Maintenance.....	41
<b>12.0</b>	<b>Water Quality Maintenance.....</b>	<b>42</b>
12.1	pH Control.....	42
12.2	Sanitizing.....	43
12.3	CD Ozone Water Maintenance System.....	43
<b>13.0</b>	<b>Error Conditions/Error Messages.....</b>	<b>44</b>
13.1	Summer Logic.....	44
13.2	Overheat Condition.....	44
13.3	Panel displays SN1.....	44
13.4	Panel displays SN2.....	45
13.5	Panel displays FL1 or FL2.....	45
13.6	Panel displays COL.....	45
13.7	Panel displays ICE.....	45
13.8	Panel displays - - -.....	46
<b>14.0</b>	<b>Troubleshooting Procedures.....</b>	<b>46</b>
14.1	None of the Components Operate (e.g. Pump, Light).....	46
14.2	Pump Does Not Operate but Light Does.....	46
14.3	Poor Jet Action.....	47
14.4	Water is Too Hot.....	47
14.5	No Heat.....	47
<b>15.0</b>	<b>North American Circuit Diagram.....</b>	<b>48</b>
<b>16.0</b>	<b>Export Circuit Diagram.....</b>	<b>49</b>
<b>17.0</b>	<b>Optional Stereo Receiver Functions.....</b>	<b>50</b>
17.1	Stereo Receiver Control Functions.....	50
17.2	Stereo Audio Receiver Specifications.....	58
17.3	CD/MP3/WMA folder/file hierarchy.....	59
17.4	Stereo Audio Receiver Troubleshooting.....	61
17.5	Standard Wireless Remote Control Functions.....	62
17.6	iPod®/MP3 Player Connection.....	64
17.7	Wireless Remote Battery Replacement Procedure.....	65

## 1.0 Important Spa Owner Information

Your new Sundance® Spa is constructed to the highest standards and is capable of providing many years of trouble-free use. However, because heat retentive materials are utilized to insulate the spa for efficient operation, an uncovered acrylic spa surface and wall fittings directly exposed to sunlight and high temperatures for an extended period are subject to permanent damage or discoloration. Damage caused by exposing the spa to this abuse is not covered under warranty. We recommend that you always keep the spa full of water when it is exposed to direct sunlight and that you keep the insulating cover in place at all times when the spa is not in use. Read and carefully follow the requirements for your spa's support base found in Section 4.0 titled, "Choosing a Location" (Page 9).

**We constantly strive to offer the finest spas available, therefore modifications and enhancements may be made which affect the specifications, illustrations and/or instructions contained herein.**

## 2.0 FCC Notice



This equipment has been tested and found to comply with the limits for a Class B Digital Device, pursuant to Part 15 of the FCC Rules. These limits are designed to provide reasonable protection against harmful interference in a residential installation. This equipment generates, uses and can radiate radio frequency energy and, if not installed and used in accordance with the instructions, may cause harmful interference to radio communications. However, there is no guarantee that interference will not occur in a particular installation. If this equipment does cause harmful interference to radio or television reception, which can be determined by turning the equipment off and on, the user is encouraged to try to correct the interference by one or more of the following measures:



1. Rearrange or relocate the receiving antenna.
2. Increase the separation between the equipment and receiver.
3. Connect the equipment into an outlet on a circuit different from the circuit connected.
4. Consult the dealer or an experienced radio/TV technician for help. Changes or modifications not expressly approved by the party responsible for FCC compliance could void the user's authority to operate this equipment.



### 3.0 Important Safety Instructions for all Spa Owners

#### READ AND FOLLOW ALL INSTRUCTIONS CAREFULLY!

This spa was manufactured to meet the standards and specifications outlined in the "Virginia Graeme Baker Pool and Spa Safety Act" (VGB Safety Act). When installing and using this spa, basic safety precautions should always be followed, including:

1.  **DANGER: RISK OF SEVERE INJURY OR DROWNING!**
  - Extreme caution must be exercised to prevent unauthorized access by children.
  - To avoid accidents, ensure that children do not use this spa unless supervised at all times. Adult supervision is a critical safety factor in preventing children from drowning.
  - Use the straps and clip tie downs to secure the spa cover when not in use. This will help discourage unsupervised children from entering the spa. Keep the spa cover secure in high-wind conditions.
  - There is no representation that the cover, clip tie-downs, or actual locks will prevent access to the spa.
  
2.  **DANGER: RISK OF SEVERE INJURY OR DROWNING!**
  - Keep hair, loose articles of clothing or hanging jewelry away from suction fittings, rotating jets or other moving components to avoid entrapment that could lead to drowning or severe injury.
  - Never use the spa unless all suction guards, filter, filter lid, or skimmer assembly are installed to prevent body and/or hair entrapment.
  - Never operate or use the spa if the filter, filter lid, or skimmer assembly are broken or any part of the skimmer assembly is missing. Please contact your dealer or nearest service center for service.
  - The suction fittings and suction covers in this spa are sized to match the specific water flow created by the pump(s). If it is necessary to replace the suction fittings, suction covers or pump(s), be sure that the flow rates are compatible and are in compliance with the VGB Safety Act.
  - Never replace a suction fitting or suction cover with one rated less than the flow rate marked on the original suction fitting. Using improper suction fittings or suction covers can create a body or hair suction entrapment hazard that may lead to drowning or severe injury.
  
3.  **DANGER: RISK OF SEVERE INJURY FROM ELECTRIC SHOCK OR DEATH FROM ELECTROCUTION!**
  - Install the spa at least 5 feet (1.5m), from all metal surfaces. As an alternative, a spa may be installed within 5 feet of metal surfaces if each metal surface is permanently connected (bonded) by a minimum No. 8 AWG (8.4 mm<sup>2</sup>) solid copper conductor attached to the wire connector on the grounding lug, inside the equipment compartment on the equipment box.

- A grounding wire connector is provided on this unit to connect a minimum No. 8 AWG (8.4 mm<sup>2</sup>) solid copper conductor between this unit and any metal equipment, metal enclosures of electrical equipment, metal water pipe, or conduit within 5 feet (1.5m) of the unit.
  - Never permit any electrical appliance, such as a light, telephone, radio, television, etc. within 5 feet (1.5m) of a spa unless such appliances are built-in by the manufacturer.
  - Never bring any electrical appliances into or near the spa.
  - Never operate any electrical appliances from inside the spa or when you are wet.
  - The electrical supply for this product must include a suitably rated switch or circuit breaker to open all ungrounded supply conductors to comply with section 422-20 of the National Electrical Code/USA, ANSI/NFPA 70. The disconnecting means must be readily accessible and visible to the spa occupant but installed at least 5 feet (1.5m), from the spa.
  - The electrical circuit supplied for the hot tub must include a suitable ground fault circuit interrupter (GFCI) as required by NEC Article 680-42.
4.  **WARNING: RISK OF SEVERE INJURY OR DEATH!**
- Extreme caution must be exercised to prevent diving or jumping into the spa or slipping and falling, which could result in unconsciousness, drowning, or serious injury. Remember that wet surfaces can be very slippery.
  - Never stand, walk or sit on the top railing of the spa.
5.  **WARNING: RISK OF HYPERTHERMIA (OVER-HEATING) CAUSING SEVERE INJURY, BURNS, WELTS OR DEATH!**
- Water temperature in excess of 104°F (40°F) may be injurious to your health.
  - Refer to section 3.2 Hyperthermia for specific causes and symptoms of this condition.
  - The water in the spa should never exceed 104°F (40°C). Water temperatures between 100°F (38°C) and 104°F (40°C) are considered safe for a healthy adult.
  - Lower water temperatures are recommended for young children (children are especially sensitive to hot water) and when spa use may exceed 10 minutes.
  - The Consumer Products Safety Commission/USA has stated that the water temperature in a spa should not exceed 104°F (40°C).
  - Always test the spa water temperature before entering the spa. The user should measure the water temperature with an accurate thermometer since the tolerance of water temperature-regulating devices may vary as much as +/- 5°F (2°C).

6.  **WARNING: RISK OF SEVERE INJURY OR DEATH!**
- Since excessive water temperatures have a high potential for causing fetal damage during the early months of pregnancy, if pregnant or possibly pregnant, consult your physician before using a spa.
  - Pregnant or possibly pregnant women should limit spa water temperatures to 100°F (38°C).
  - Persons suffering from obesity or a medical history of heart disease, low or high blood pressure, circulatory system problems, diabetes, infectious diseases or immune deficiency syndromes should consult a physician before using a spa.
  - If you experience breathing difficulties in association with using or operating your spa, discontinue use and consult your physician.
  - Persons using medication should consult a physician before using a spa since some medication may induce drowsiness, while other medication may affect heart rate, blood pressure, and circulation.
  - Persons suffering from any condition requiring medical treatment, the elderly, or infants should consult with a physician before using a spa.
  - The use of alcohol, drugs, or medication before or during spa use may lead to unconsciousness with the possibility of drowning.
7.  **WARNING: RISK OF SEVERE INJURY OR DEATH!**
- Prolonged immersion in a spa may be injurious to your health.
  - Observe a reasonable time limit when using the spa. Exposures at higher temperatures can cause high body temperature (over-heating). Symptoms may include dizziness, nausea, fainting, drowsiness, and reduced awareness. These effects could possibly result in drowning or serious injury.
  - Never use a spa immediately following strenuous exercise. Enter and exit the spa slowly. Wet surfaces can be slippery.
8.  **WARNING: TO DECREASE RISK OF INFECTION OR DISEASE!**
- To reduce the risk of contracting a waterborne illness (e.g. an infection, bacteria or virus) and/or respiratory ailments, maintain water chemistry within the parameters listed on the inside cover of this manual and consult with a licensed engineer regarding proper ventilation if installed indoors or in an enclosed area.
  - People with infectious diseases should not use a spa to avoid water contamination, which could result in spreading infections to others.
  - Always shower before and after using your spa. Maintain water chemistry in accordance with manufacturer's instructions. Failure to do so may result in contracting a waterborne illness (e.g. an infection, bacteria or virus).



9.  **WARNING:** In addition to maintenance of filters and water chemistry, proper ventilation is recommended to reduce the risk of contracting a waterborne illness (e.g. an infection, bacteria or virus) and/or respiratory ailments that could be present in the air or water. Consult a licensed architect or building contractor to determine your specific needs if installing your hot tub indoors.
10. **CAUTION: TO DECREASE RISK OF PRODUCT DAMAGE.**
- Maintain water chemistry in accordance with manufacturer's instructions.
  - Proper chemical maintenance of spa water is necessary to maintain safe water and prevent possible damage to spa components.
11. **NOTE:**
- This spa is not intended nor designed to be used in a commercial or public application. The spa buyer shall determine whether there are any code restrictions on the use or installation of this spa since local code requirements vary from one locality to another.

## Hot Tub Safety Literature

To ensure you have a safe and enjoyable hot tub experience, learn all you can about hot tub safety and emergency procedures. Especially useful are the brochures listed below:

- [Children Aren't Waterproof](#)
- [Pool and Spa Emergency Procedures For Infants and Children](#)
- [Layers of Protection](#)
- [The Sensible Way to Enjoy Your Spa or Hot Tub](#)

The Association of Pool and Spa Professionals publishes these brochures. To acquire a brochure:

- Ask your hot tub dealer (they may have copies)
- Go to <http://www.apsp.org>
- Conduct your own search on the internet
- Write to the following address:

The Association of Pool and Spa Professionals  
 2111 Eisenhower Avenue  
 Alexandria VA 22314  
 703.838.0083



### 3.1 Entrapment Risk



The Consumer Products Safety Commission/USA has reported that users of pools and spas have become entrapped (stuck) to drain and/or suction fittings causing death, drowning, or serious injury (see diagram below). This spa was manufactured to meet the standards and specifications outlined in the "Virginia Graeme Baker Pool and Spa Safety Act" (VGB Safety Act). Entrapment risk can be minimized if proper precautions are taken.

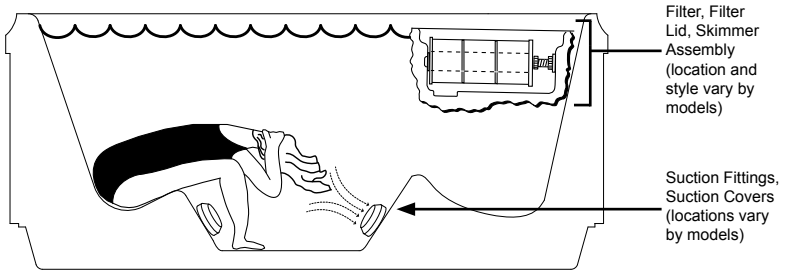

**DANGER: RISK OF PERSONAL INJURY OR DEATH!**  
 Never operate the spa if a suction fitting, suction cover, filter, filter lid or skimmer assembly are broken, damaged or missing.



1.  **DANGER: RISK OF SEVERE INJURY OR DROWNING!**  
**Hair entrapment:** May occur if hair is entangled, knotted or snagged in a drain suction or skimmer assembly. This has been reported in persons who when submerge themselves underwater, allowing hair to come close and/or within the reach of the suction fittings, suction covers or skimmer assembly.
  - Keep hair away from suction fittings, suction covers, filter, filter lid or skimmer assembly.
  - Children are at risk for hair entrapment if swimming under water.
  - Never allow children to play or get near the suction fittings, suction covers, filter, filter lid or skimmer assembly.
  
2.  **DANGER: RISK OF SEVERE INJURY OR DROWNING!**  
**Limb entrapment:** May occur when a limb becomes entrapped, inserted or sucked into a suction or outlet opening.
  - Always keep suction fittings, suction covers, filter, filter lid or skimmer assembly in place when operating to avoid limb entrapment.
  - Never allow children to play or get near the suction fittings, suction covers, filter, filter lid or skimmer assembly.

3.  **DANGER: RISK OF SEVERE INJURY OR DROWNING!**  
**Body entrapment:** May occur when part of the torso becomes entrapped, inserted or sucked into a suction or outlet opening.
- Never allow children to play or get near the suction fittings, suction covers, filter, filter lid or skimmer assembly.
4.  **DANGER: RISK OF SEVERE INJURY OR DROWNING!**  
**Evisceration (disembowelment) entrapment:** May occur when the buttocks becomes entrapped, inserted or sucked into a suction or outlet opening.
- Never sit on suction fittings, suction covers, filter, filter lid or skimmer assembly.
  - Never allow children to play or get near the suction fittings, suction covers, filter, filter lid or skimmer assembly.
5.  **DANGER: RISK OF SEVERE INJURY OR DROWNING!**  
**Mechanical entrapment:** May occur when jewelry, swimsuit, or hair accessories become entangled, knotted or snagged in a drain suction or skimmer assembly.
- Never allow your jewelry, swimsuit, or hair accessories to come close to the suction fittings, suction covers or skimmer assembly.
  - Never allow children to play or get near the suction fittings, suction covers, filter, filter lid or skimmer assembly.

### 3.2 Hyperthermia

Prolonged immersion in hot water may induce hyperthermia (overheating). The use of alcohol or drugs can greatly increase the risk of fatal hyperthermia in spas. A description of the causes, symptoms, and effects of hyperthermia are as follows:

Hyperthermia occurs when the internal temperature of the body reaches a level several degrees above the normal body temperature of 98.6°F (37°C). The symptoms of hyperthermia include drowsiness, lethargy (fatigue), and an increase in the internal temperature of the body (feeling of being too hot). The effects of hyperthermia include:

- Unawareness of impending hazard;
- Failure to perceive heat;
- Failure to recognize the need to exit spa;
- Physical inability to exit spa;
- Fetal damage in pregnant women; and
- Unconsciousness and DANGER of drowning.

A Warning Sign is provided in your warranty packet. Please install at a location near your spa, where it is visible to users of the spa. For additional or replacement Warning Signs please contact your local Sundance spas dealer and reference item number #6530-082.

### **3.3 Important Additional CSA Safety Instructions (Canada Only)**

When using this electrical equipment, basic safety precautions should always be followed, including the following:

- 1. READ AND FOLLOW ALL INSTRUCTIONS.**
- A green colored terminal or a terminal marked G, Gr, Ground, Grounding or the  symbol\* is located inside the supply terminal box or compartment. To reduce the risk of electric shock, this terminal must be connected to the grounding means provided in the electric supply service panel with a continuous copper wire equivalent in size to the circuit conductors that supply this equipment (\*IEC Publication 417, Symbol 5019).
- At least two lugs marked "Bonding Lugs" are provided on the external surface or on the inside of the supply terminal box/compartment. To reduce the risk of electric shock, connect the local common bonding grid in the area of the spa to these terminals with an insulated or bare copper conductor not smaller than No. 6 AWG (10 mm<sup>2</sup>).
- All field-installed metal components such as rails, ladders, drains or other similar hardware within 10 feet (3m) of the spa shall be bonded to the equipment grounding buss with copper conductors not smaller than No. 6 AWG (10 mm<sup>2</sup>).
- 5. SAVE THESE INSTRUCTIONS.**

### **3.4 General Electrical Safety Instructions**

Your new Sundance® Spa is equipped with a "state-of-the-art" equipment system. It contains the most advanced safety and self-protective equipment in the industry. Nonetheless, this spa must be installed properly to ensure dependable usage. Please contact your local Sundance dealer or local building department should you have any questions regarding your installation.

Proper grounding is extremely important. Sundance spas are equipped with a current collector system. A pressure wire connector is provided on the surface of the control box, located outside the equipment door (Figure B, page 14) to permit connection of a bonding wire between this point and any ground metal equipment, metal water pipe or conduit within 5 feet (1.5m) of the spa, or copper clad grounding rod buried within 5 feet (1.5m) of the spa. Bonding wire must be at least No. 8 AWG (8.4 mm<sup>2</sup>) solid copper wire. This is a most important safety assurance feature.

Before installing your spa, check with your local building department to ensure installation conforms to local building codes.

## 4.0 Choosing A Location

**IMPORTANT:** Because of the combined weight of the spa, water and users, it is extremely important that the base upon which the spa rests be smooth, flat, level and capable of uniformly supporting this weight, without shifting or settling, for the entire time the spa is in place. If the spa is placed on a surface which does not meet these requirements, damage to the skirt and/or the spa shell may result. Damage caused by improper support is not covered under warranty. It is the responsibility of the spa owner to assure the integrity of the support over time. We recommend a poured, reinforced concrete slab with a minimum thickness of 4 inches (10 cm). Wood decking is also acceptable provided it is constructed so that it meets the requirements outlined above.



**WARNING:** For spas that are to rest on balconies, roofs or other platforms not specifically tied into main structural support, consult a professional Structural Engineer with experience in this type of application.

The spa must be installed in such a manner as to provide drainage away from it. Placing the spa in a depression without provisions for proper drainage could allow rain, overflow and other casual water to flood the equipment and create a wet condition in which it would sit in. For spas which will be recessed into a floor or deck, install so as to permit access to the equipment, either from above or below, for servicing. Make certain that there are no obstructions which would prevent removal of all side cabinet panels and access to the jets components, especially on the side with the equipment bay doors.



**CAUTION:** If the spa is indoors or located in an enclosed area, proper ventilation should be discussed with an Engineer or authority competent enough to understand the necessary provisions needed to vent moist or heated air and air associated with chemical odors outdoors. **When the spa is in use considerable amounts of moisture will escape potentially causing mold and mildew.** This can cause health risk. Over time, this can damage certain surfaces, surroundings, and equipment.

### 4.1 Outdoor Location

In selecting the ideal outdoor location for your spa, we suggest that you take into consideration the following:

- The proximity to changing area and shelter (especially in regions subject to cold weather).

- The pathway to and from your spa (this should be free of debris so that dirt and leaves are not easily tracked into the spa).
- The closeness to trees and shrubbery (remember that leaves and birds could create extra work in keeping the spa clean).
- A sheltered environment (less wind and weather exposure can result in lowered operation and maintenance costs).
- The overall enhancement of your environment. It is preferable not to place the spa under an unguttered roof overhang since run-off water will shorten the life expectancy of the spa cover.
- For spas that are to rest on balconies, roofs or other platforms not specifically tied into main structural support, consult a professional Structural Engineer with experience in this type of application.

#### 4.2 Indoor Location

For indoor installations many factors need to be considered before installing a spa indoors:



**WARNING:** In addition to maintenance of filters and water chemistry, proper ventilation is recommended to reduce the risk of contracting a waterborne illness (e.g. an infection, bacteria or virus) and/or respiratory ailments that could be present in the air or water. Consult a licensed architect or building contractor to determine your specific needs if installing your hot tub indoors.

- **PROPER FOUNDATION:** Consult a Structural Engineer when considering a foundation that will adequately support the spa the entire time it is in place. Proper support is critical especially if the spa is to rest on a second story or higher. For spas that are to rest on balconies, roofs or other platforms not specifically tied into the main structural support, you should consult a professional Structural Engineer with experience in this type of application.
- **PROPER DRAINAGE:** It is extremely important to have in place measures to sufficiently handle excessive water spillage. Be sure the flooring in which the spa rests on has adequate drainage and can handle draining of the entire contents of the spa. Be sure to make provisions for ceilings or any other structures that may be below the spas installation. Areas around your spa can become wet or moist so all flooring and subsequent furniture, walls and adjacent structures should be able to withstand or resist water and moisture.

- **PROPER VENTILATION:** Proper ventilation should be discussed with an Engineer or authority competent enough to understand the necessary provisions needed to vent moist or heated air and air associated with chemical odors outdoors. When the spa is in use considerable amounts of moisture will escape potentially causing mold and mildew, over time this can damage certain surfaces and or surroundings.
- **SUFFICIENT ACCESS:** In the unlikely event that you should ever need to access or gain entry to any portion of the spa for servicing, it is highly recommended that you plan your indoor installation to provide full access to the entire spa.
- **WARRANTY:** Damage caused by not following these guidelines or any improper installation not in accordance with local codes or authorities is not covered under the spas warranty. Please consult your local state or city building ordinances.

## 5.0 Power Requirements

Sundance® spas are designed to provide optimum performance and flexibility of use when connected to the maximum electrical service listed on page 12. If you prefer, your qualified technician can perform a minor circuit board modification to allow your spa to accept an electrical service other than the factory setting.

**Note:** Refer to pages 48-49 for circuit board configuration details or contact your authorized Sundance dealer.

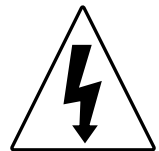

**5.1 North American 60 Hz Power Options**

<b>North American 2-Pump Models (60 Hz)</b>			
	<u><b>240V/40A*</b></u>	<u><b>240V/50A**</b></u>	<u><b>240V/60A***</b></u>
Voltage:	240 VAC	240 VAC	240 VAC
# of Wires:	3	3	3
Frequency:	60 Hz	60 Hz	60 Hz
Current Draw:	26A	36A	45A
Circuit Breaker:	40A*, 2-Pole	50A**, 2-Pole	60A***, 2-Pole
<p>* In 40A configuration, the heater <b>will not operate</b> while either jets pump is running in high speed. <b>Note: pump 2 runs only in high speed.</b></p> <p>** In 50A configuration, the heater <b>will not operate</b> while both jets pumps are running in high speed. <b>Note: pump 2 runs only in high speed. <u>This is the factory setting.</u></b></p> <p>*** In 60A configuration, the heater <b>will operate</b> while both jets pumps are running in high speed. <b>Note: pump 2 runs only in high speed.</b></p>			

**5.2 Export 50 Hz Power Options**

<b>Export 2-Pump Models (50 Hz)</b>			
	<u><b>230V/20A*</b></u>	<u><b>230V/30A**</b></u>	<u><b>230V/40A***</b></u>
Voltage:	230 VAC	230 VAC	230 VAC
# of Wires:	3	3	3
Frequency:	50 Hz	50 Hz	50 Hz
Current Draw:	15A	23A	29A
Circuit Breaker:	20A*	30A**	40A***
<p>* In 20A configuration, the heater <b>will not operate</b> while either jets pump is running in high speed. <b><u>This is the factory setting.</u> Note: pump 2 runs only in high speed.</b></p> <p>** In 30A configuration, the heater <b>will not operate</b> while both jets pumps are running in high speed. <b>Note: pump 2 runs only in high speed.</b></p> <p>*** In 40A configuration, the heater <b>will operate</b> while both jets pump are running in high speed. <b>Note: pump 2 runs only in high speed.</b></p>			



## 6.0 Electrical Wiring Instructions

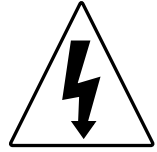

**IMPORTANT NOTICE:** The electrical wiring of this spa must meet the requirements of the National Electrical Code (NEC) and any applicable state or local codes. The electrical circuit must be installed by a qualified electrician and approved by a local building/electrical inspection authority.

1. **Dedicated 240V Power Models:** These spas must be permanently connected (hard-wired) to the power supply. **No plug-in connections or extension cords are to be used in conjunction with the operation of these spas.** Supplying power to these spas which is not in accordance with these instructions will void both the independent testing agency listing and the manufacturer's warranty.
2. The power supplied to this spa must be a dedicated circuit with no other appliances or lights sharing the power provided by the circuit.
3. To determine the current, voltage and wire size required, refer to Section 5.0 "Power Requirements" (page 12).
  - Wire size must be appropriate per NEC and/or local codes.
  - We recommend type THHN wire.
  - All wiring must be copper to ensure proper connections. **Do not use aluminum wire.**
  - When using wire larger than #6 (10 mm<sup>2</sup>), add a junction box near the spa and reduce to short lengths of #8 (8.4 mm<sup>2</sup>) wire to connect to the spa.
4. The electrical supply for this product must include a suitably rated switch or circuit breaker to open all ungrounded supply conductors to comply with Section 422-20 of the National Electrical Code, ANSI/NFPA 70. The disconnecting means must be readily accessible and visible to the hot tub's occupant but installed at least 5 feet (1.5m) from the hot tub.
5. The electrical circuit supplied for the spa must include a suitable ground fault circuit interrupter (GFCI) as required by NEC Article 680-42.
6. To gain access to the spa's power terminal block, remove the screws securing the cabinet panel on the side of the spa under the controls. Then remove the four control box door screws and door (Figures A-B).
7. Select the power supply inlet you want to use (Figure A, page 14). Feed power cable to control box, then install it through the large opening provided in the bottom side of the box.
8. Connect wires, color to color, on terminal blocks TB1 and TB3 (Figures C-D, page 15). **TIGHTEN SECURELY!** All wires must be hooked up securely or damage could result.
9. Install control box door and screws and reinstall the cabinet panels.

**Figure A  
Equipment Area**

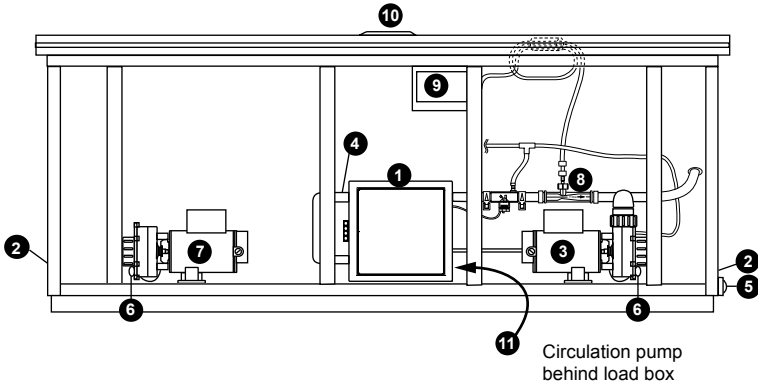

- |                             |  |
|-----------------------------|--|
| 1. Control Box              | 8. Ozone injector  |
| 2. Power Supply Entrance(s) | 9. Optional CD Ozonator Injector Connection (Purchased separately on North American models; standard equipment on export models) |
| 3. 2-Speed Pump #1          | 10. Control Panel  |
| 4. Heater                   | 11. Circulation Pump   |
| 5. Spa Drain Valve          |  |
| 6. Pump Drain Plugs         |  |
| 7. 1-Speed Pump #2          |  |

**Figure B  
Control Box**

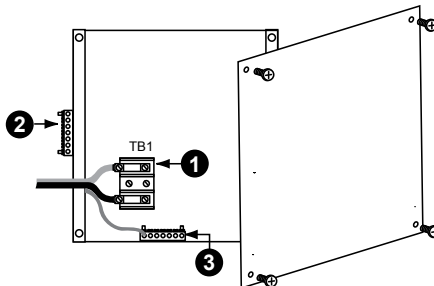

- |                       |
|-----------------------|
| 1. Terminal Block     |
| 2. Bonding Lug        |
| 3. Grounding Terminal |

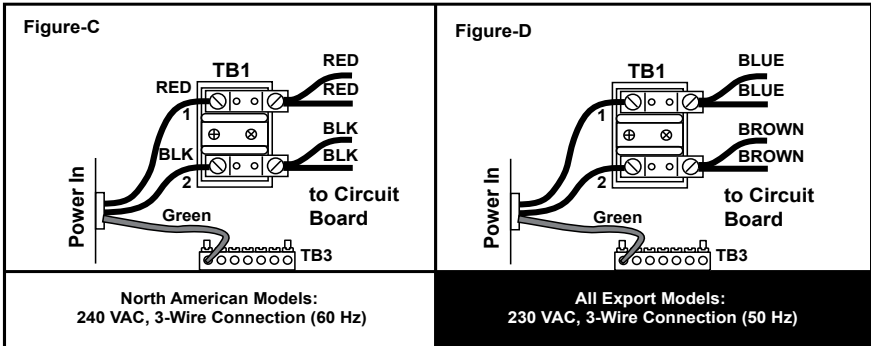

## 7.0 Spa Fill Up Procedure

For best results, read each step in its entirety before proceeding with that step.

### 1. Prepare The Spa For Filling

- Clear all debris from the spa. (Although the spa shell has been polished at the factory, you may want to treat it with a specially formulated spa cleaner.) Consult your dealer for additional information prior to filling spa.
- Remove filter lid (page 22 and 25), then remove filter cartridge from filter bucket as illustrated in Section 11.1 (pages 35-36).

### 2. Fill Spa

- Place the end of your garden hose into the empty filter bucket.

**CAUTION: TO DECREASE BUILD UP ON COMPONENTS AND MINIMIZE ACRYLIC DAMAGE.**

Never fill with water from a water softener. If your water is extremely "hard", it is preferable to fill half-way with hard water and the rest of the way with softened water. Water that is too soft can be corrosive to metal components.

- **WARNING: TO DECREASE RISK OF INFECTION OR DISEASE.**

Fill hot tub with clean tap water from garden hose, to reduce risk of contracting a waterborne illness (e.g. an infection, bacteria or virus) and/or respiratory ailments. Fill until water covers all jets but does not touch the bottom of the lowest headrest. (DO NOT OVERFILL!)

**IMPORTANT:** Always fill your spa through the filter bucket after draining. Failure to do so may cause air to be trapped in either pump, preventing the pump from circulating water. Remove the hose and replace the filter cartridge as illustrated in Section 11.1 (pages 35-36).

**3. Turn On Power**

Turn on power to spa at the home's circuit breaker to start boot up sequence (Section 9.0, page 28). The heater and filter/circulation pump will automatically activate after several seconds. If the control panel LED flashes water temperature and "COOL" or "ICE" this is normal. Refer to page 45 for additional information.

**4. Activate Jets Pumps**

Turn on all jet(s) pumps to ensure proper mixing when adding start-up chemical in step 5.



**5. Add Start-Up Chemicals**

Add the spa water chemicals as recommended by your Sundance dealer. See Section titled "Water Quality Maintenance" (page 42) for general guidance.



**WARNING: RISK OF POISONING OR DEATH.**  
**Never leave chemicals opened and accessible to anyone.**  
**Use chemicals according to the vendors instructions.**  
**Always store chemicals in a safe and/or locked location.**  
**Keep away from and out of reach of children.**

**6. Establish A Stable Sanitizer Reading**

Establish a stable sanitizer reading between 3.0-4.0 ppm chlorine or 2.0-4.0 ppm bromine. To ensure healthy water conditions, always maintain a constant sanitizer reading within the levels recommended by the Association of Pool and Spa Professionals/USA printed on the inside cover of this manual. If sanitizer levels cannot be stabilized, perform the decontamination procedure steps 9-15 on the following page.

**Note:** The "decontamination procedure" steps 9-15 should also be used after the spa has been "Winterized" (Section 11.7, page 40) or has been sitting without power for an extended period.

## 7. Set Spa To Heat

To warm spa water to a comfortable temperature, follow these steps:



- The LED display on the control panel displays the actual temperature of the spa water. Press either the **COOLER** (▼) or **WARMER** (▲) button once to display the “set” temperature for 5 seconds. If you want the water to heat to a different temperature, simply press **COOLER** or **WARMER** within 5 seconds. The set temperature increases or decreases by one degree each time one of these buttons is pressed.
- The heater will turn off when the temperature corresponding to the thermostat setting is achieved.

### Important Heater Details:

- The maximum temperature for which the spa can be set is 104°F (40°C) and the minimum is 65°F (18°C).
- For North American 2-pump spas powered by a 40 amp service, jets pump #1 must be set to low speed and jets pump #2 must be turned off to operate the heater.
- For Export (50 Hz) 2-pump spas powered by a 20 amp service, jet pump #1 must be set to low speed and jets pump #2 must be turned off to operate the heater.
- Setting the thermostat at maximum will not accelerate the heating process. This will only result in a higher ultimate temperature.
- The heater operates until the water reaches the programmed “set temperature”, then turns off. The heater will reactivate after the water cools to approximately 1.5° below the “set temperature”.

## 8. Place Cover On Spa

- Keeping the insulating cover in place anytime the spa is not in use will reduce the time required for heating, thereby minimizing operating costs.
- The time required for initial heat-up will vary depending on the starting water temperature.



### **DANGER: RISK OF PERSONAL INJURY.**

Check water temperature carefully before entering hot tub!  
Excessive water temperature can cause burns, welts and body temperature to rise, hyperthermia (over-heating).

**Decontamination Procedure (Steps 9-15)**

Steps 9-15 below are only required when sanitizer levels are unstable after performing steps 1-6 above. Disregard steps 9-15 below if sanitizer levels remain stable at 3.0-4.0 ppm chlorine or 2.0-4.0 ppm bromine after performing steps 1-6 above.

9. Add 2.5 ounces (71 g) of sodium dichlor for every 100 gallons (378 Liters) of water. Refer to the table for approximate water fill volume by model.



**CAUTION: RISK OF PERSONAL INJURY OR SPA DAMAGE!**

Never add chlorine tablets (trichlor) or acid to your hot tub for any reason! These chemical may damage components within your hot tub, burn or irritate your skin, create a rash, and void the manufacturer warranty for your spa.

**Water Fill Capacity by Model**

<b>Model</b>	<b>Average Fill Volume*</b>	<b>Sodium dichlor</b>
Constance .....	375 Gal (1,419 L).....	9.5 oz
Victoria.....	410 Gal (1,552 L).....	10.0 oz

\*Use average fill volume for chemical maintenance.

10. Leave spa cover open during this step to allow excessive chemical vapors to exit spa, protecting pillows and plastic knobs from chemical attack. If spa is indoors, open doors and windows for proper ventilation. Turn on all spa jets pumps for one hour, open all air controls, and place all massage selector knob(s) in their center "combo" position as shown (right).



**Note:** You will need to press the jets pump button(s) every 20 minutes since these functions have an automatic 20 minute time-out function that turns them off.

**WARNING: BECAUSE OF THE RISK OF INHALING CHEMICAL VAPORS.**

- To decrease the risk of injury, drowning or entrapment, never leave your hot tub unattended for any reason while the cover is open and accessible, especially to small children and animals!
- Precautions should be taken to minimize your exposure to chemical vapors (that could cause lung, brain, or skin damage).

11. Turn off power to the spa at the circuit breaker, then drain spa as outlined in Section 11.2 (pages 37-38).
12. Refill spa with clean tap water from garden hose until water covers all jets but does not touch the bottom of the lowest headrest. (DO NOT OVERFILL!)

**CAUTION: TO DECREASE BUILD UP ON COMPONENTS AND MINIMIZE ACRYLIC DAMAGE.**

Never fill with water from a water softener. If your water is extremely "hard", it is preferable to fill half-way with hard water and the rest of the way with softened water. Water that is too soft can be corrosive to metal components.

13. Consult your authorized Sundance dealer for chemical recommendations, then add chemicals to spa water to achieve a constant sanitizer reading within the levels recommended by the Association of Pool and Spa Professionals/USA printed on the inside cover of this manual.
14. Turn on all jet pumps when adding chemicals to ensure proper mixing and leave your spa cover open until the sanitizer level falls below 4.0 ppm to protect pillows and plastic knobs from chemical attack.



**WARNING: RISK OF PERSONAL INJURY.**

- To decrease the risk of injury, entrapment or drowning, never leave your hot tub unattended for any reason, especially if while the cover is open and accessible to small children and animals!
- To decrease the risk of contracting a waterborne illness (e.g. an infection, bacteria or virus) and/or respiratory ailments, maintain water chemistry within 6 step parameters. If you or other bathers experience such a condition, discontinue use and seek immediate medical attention.

15. Establish a sanitizer reading between 3.0-4.0 ppm chlorine or 2.0-4.0 ppm bromine, then allow the spa to set undisturbed for 8 hours. Retest water after 8 hours to determine if sanitizer levels are stable. If sanitizer levels are stable, your spa is ready for use. To ensure healthy water conditions, always maintain a constant sanitizer reading within the levels recommended by the Association of Pool and Spa Professionals/USA printed on the inside cover of this manual. If sanitizer levels are not stable at this time, it will be necessary to repeat this procedure in its entirety (steps 1-15) until stable sanitizer readings are achieved.
16. After adequate sanitizer levels are achieved, close all spa air controls to maximize heat retention when spa is not in use.



## 8.0 Control Functions

### 8.1 Control Panel

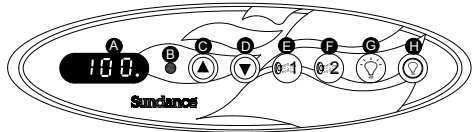

- A. **LED Display:** Can display current water temperature (default display), water temperature set point, selected filtration/heating mode, and error messages.
- B. **Heat Indicator:** Lit when heater is on.
- C. **Warmer (▲) Button:** Increases water temperature set point.
- D. **Cooler (▼) Button:** Decreases water temperature set point.
- E. **Jets 1 Button:** Turns jets pump #1 on and off. Press once for low speed; press a second time for high speed; press a third time to turn pump #1 off.
- F. **Jets 2 Button:** Turns high-speed jets pump #2 on and off. Press once to turn on; press a second time to turn pump #2 off.
- G. **Light On/Off Button:** Turns waterfall, footwell and air control lights on in unison. Press once for high intensity; press a second time for medium intensity; press a third time for low intensity; press a fourth time to turn off. The displayed color is changed using the light mode button (H) below.
- H. **Light Mode Button:** Selects one of 4 color modes for waterfall, footwell, and air control lights. See page 29 for additional information.

### Operation Details

- Temperature Adjustment: 65-104°F (18-40°C). Factory default setting is 100°F (38°C).
- All lighting systems run for 2 hours then shut off.
- Jets 1/Jets 2 Button Operation: Jets run for 20 minutes after activated, then turn off automatically to conserve energy. Simply press either jets button to continue operation for an additional 20 minutes.

8.2 Victoria Spa Features

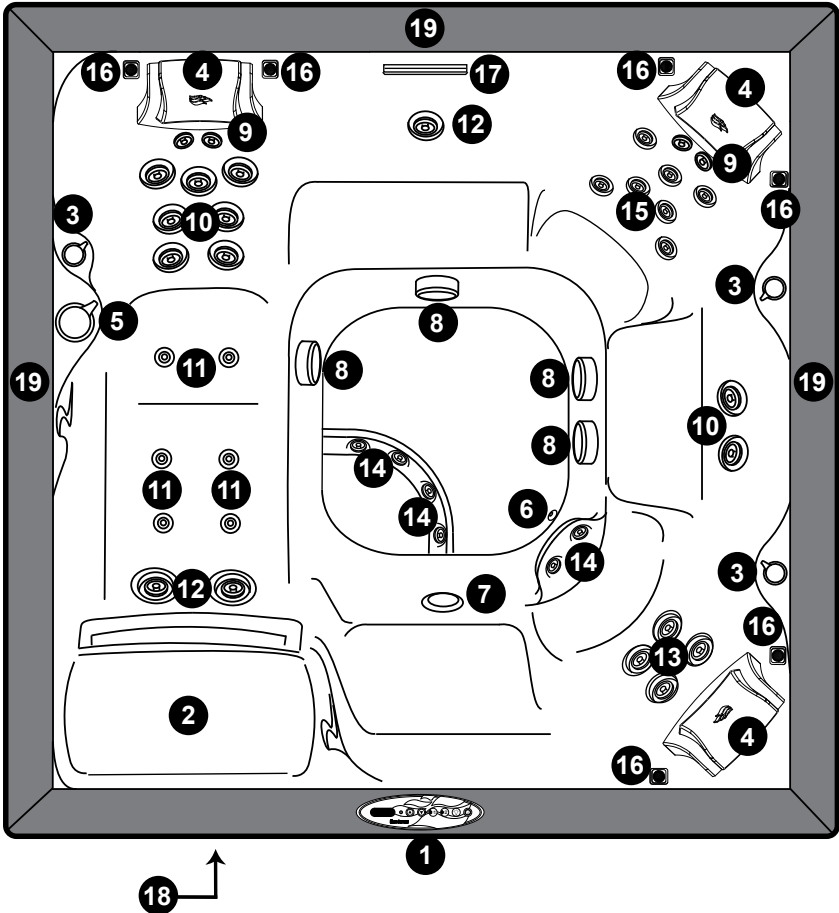

- |   |  |
|---|--|
| 1. Control Panel                                    | 12. Vortex (3)   |
| 2. Filter Lid & Filter Cartridge                    | 13. Fluidix Intelli-Jets (4)                                     |
| 3. Air Controls w/LED Light (3)                     | 14. Accu-Pressure Jets (6)                                       |
| 4. Pillows (3)                                      | 15. Fluidix ST Jets (7)  |
| 5. Massage Selector                                 | 16. Optional Audio System Speakers, 6 each                       |
| 6. Gravity Drain/Ozone Return/Heater Return Fitting | 17. Waterfall w/LED Light  |
| 7. Spa Light  | 18. Optional Stereo Receiver with MP3 player connector (page 50) |
| 8. Suction Fittings (4)                             | 19. Top Railing  |
| 9. Nex Jets (4)                                     |  |
| 10. Fluidix Reflex Jets (9)                         |  |
| 11. SMT Micro Jets (6)                              |  |

Spa features subject to change without notice.

## 8.3 Victoria Air Controls Diagram

### Air Control Operation

Rotate Air Controls 1-3 to add air to designated jet groups.

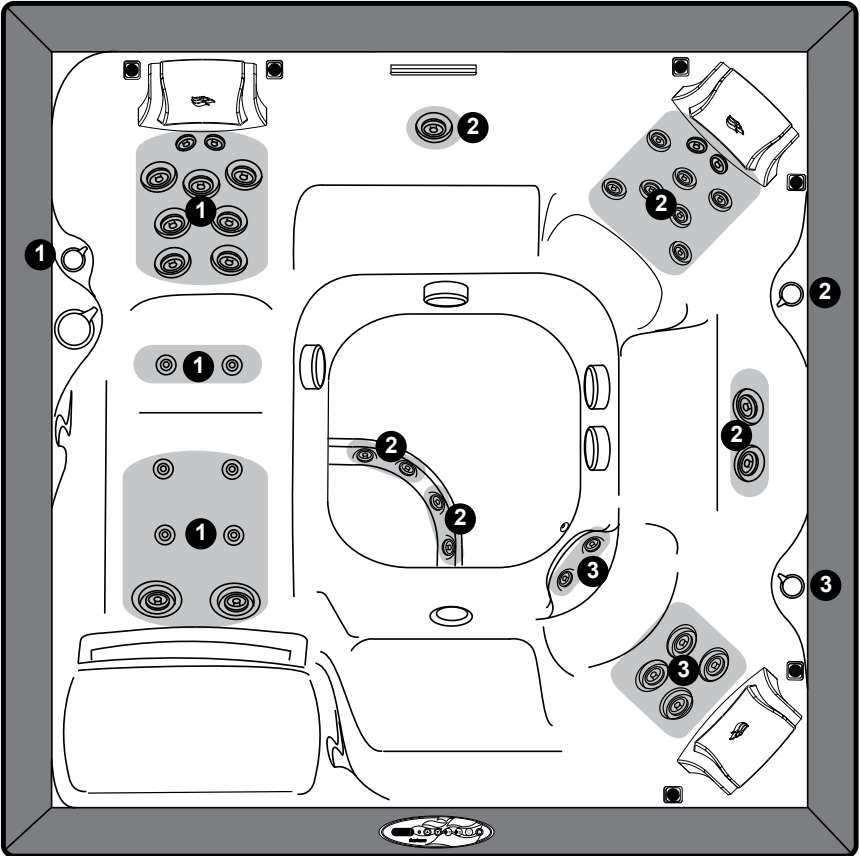

Spa features subject to change without notice.

## 8.4 Victoria Massage/Waterfall Selector Diagram

### Massage Selector Operation

Rotate Massage Selector 1 to divert water between designated jet groups.

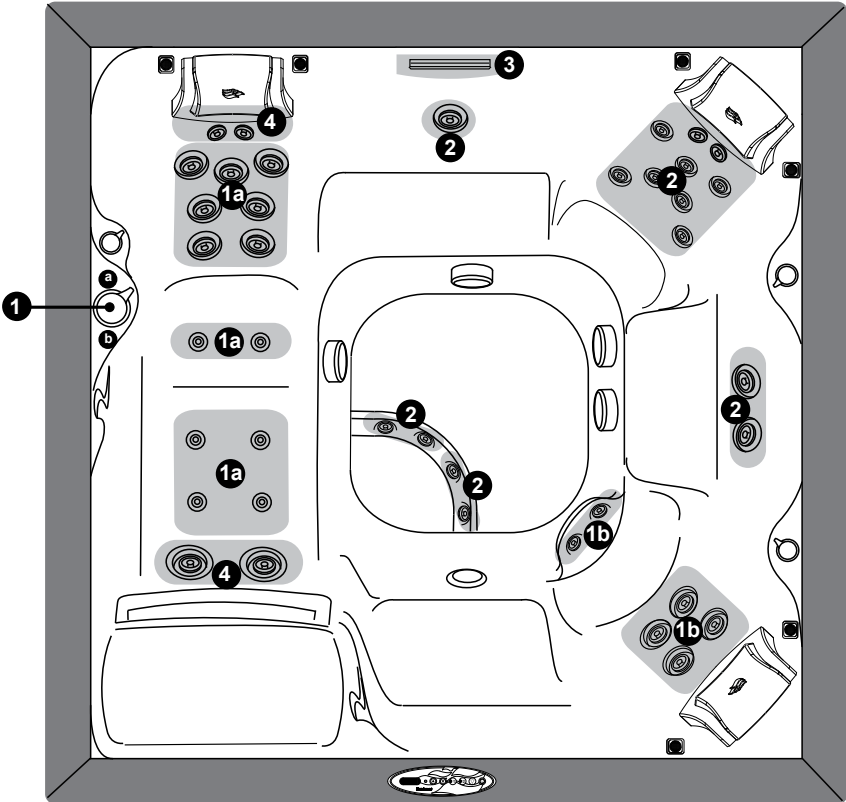

#### Massage Selectors (1)

- Massage Selector #1 controls pump #1.

#### Jets (2)

- These jets are always on when the jets pump #2 is running.

#### Waterfall (3)

- Waterfall is on when the jets pump 1 is running.

#### Continuously Powered Jets (4)

- Jets #4 are always on when jets pump #1 is running.

Spa features subject to change without notice.

## 8.5 Constance Spa Features

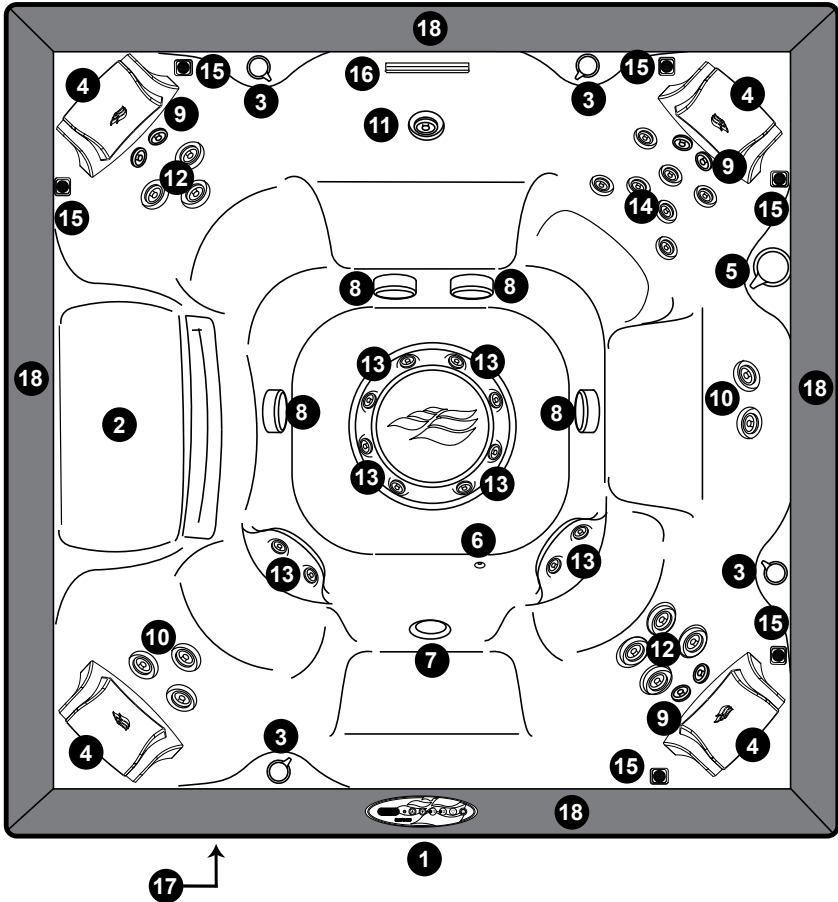

- |   |   |
|---|---|
| 1. Control Panel  | 12. Fluidix Intelli-Jets (7)  |
| 2. Filter Lid & Filter Cartridge                        | 13. Accu-Pressure Jets (12)   |
| 3. Air Controls w/LED Light (4)                         | 14. Fluidix ST Jets (7)   |
| 4. Pillows (4)  | 15. Optional Audio System Speakers, (6)                             |
| 5. Massage Selector                                     | 16. Waterfall w/LED Light   |
| 6. Gravity Drain/Ozone Return/<br>Heater Return Fitting | 17. Optional Stereo Receiver with<br>MP3 player connector (page 50) |
| 7. Spa Light  | 18. Top Railing   |
| 8. Suction Fittings (4)                                 |   |
| 9. Nex Jets (6)   |   |
| 10. Fluidix Reflex Jets (5)                             |   |
| 11. Vortex (1)  |   |

Spa features subject to change without notice.

**8.6 Constance Air Controls Diagram**

**Air Control Operation**

Rotate Air Controls 1-4 to add air to designated jet groups.

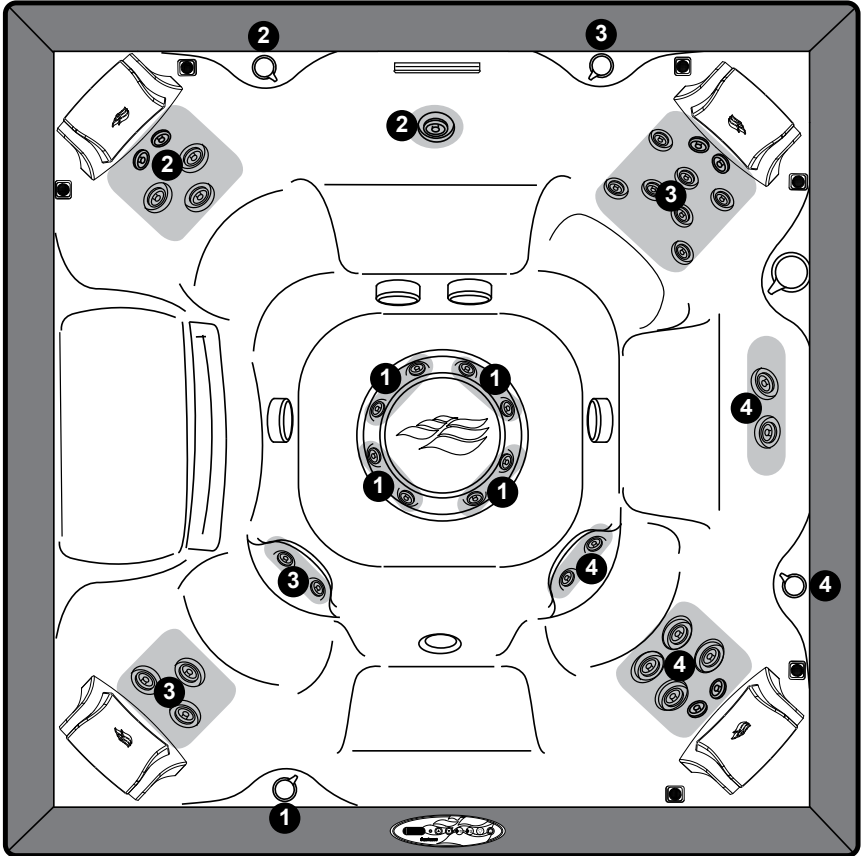

Spa features subject to change without notice.

## 8.7 Constance Massage/Waterfall Selector Diagram

### Massage Selector Operation

Rotate Massage Selector 1 to divert water between designated jet groups.

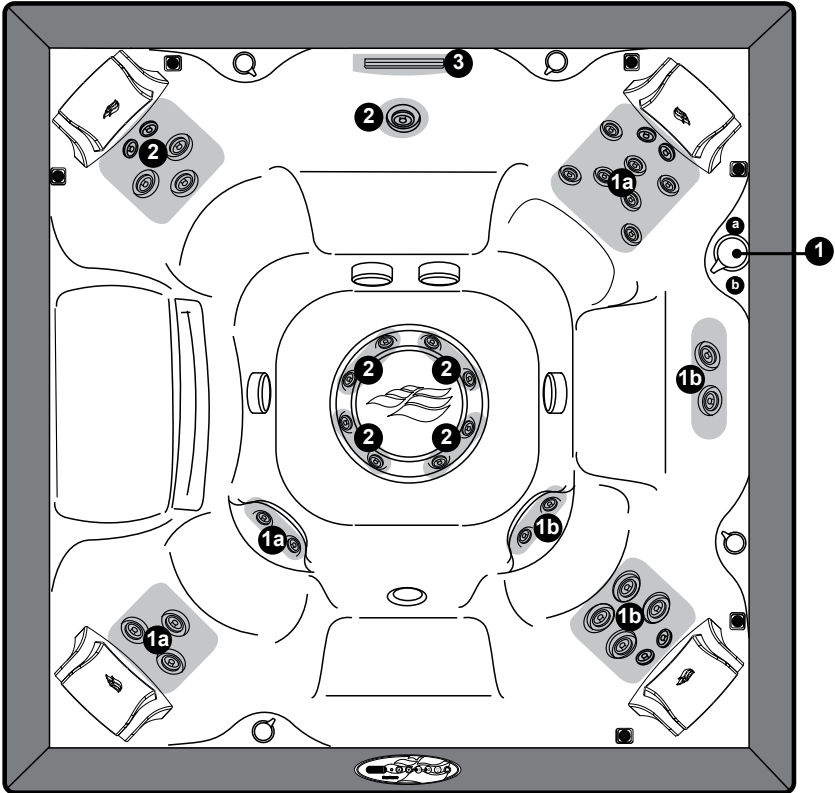

#### Massage Selectors (1)

- Massage Selector #1 controls pump #1.

#### Jets (2)

- These jets are always on when the jets pump #2 is running.



#### Waterfall (3)

- Waterfall is on when the jets pump 1 is running.

Spa features subject to change without notice.

## 9.0 Operating Instructions

The spa control system has automatic functions that operate upon startup and normal operation to protect the system. Upon power up, the readout displays the following information:

1. Control panel displays current software release (e.g. 3.58). 
2. Control panel displays "888" and all indicator LEDs are lit, permitting visual inspection of all display segments and indicator lights for proper operation. 
3. After the initial start-up sequence ends, the actual water temperature is displayed. If water temperature at this time is less than the factory default temperature setting of 100°F (38°C) and the spa is set to either of the standard filtration/heating modes (page 33), the heater will turn on and run until the water temperature rises to the factory setting, then turn off. 

**Note:** It is common for the heater to turn on after the spa is first filled because tap water is often very cold.

4. Approximately two minutes after power is applied to the spa, the first filtration/heating cycle turns on pump 1. An automatic five minute "blow-out" function also activates pump 2 for a period of five minutes to flush all lines. Then, after five minutes, pump 2 turns off and pump 1 continues to operate for the duration of the cycle.

**Note:** This function only occurs during the first filtration/heating cycle each day.

## 9.1 Setting Water Temperature

The spa's thermostat provides optimum control of water temperature. The temperature setpoint (set temperature) can be adjusted from 65-104°F (18-40°C). To raise the set temperature, press the **WARMER** (▲) button. To lower the set temperature, press the **COOLER** (▼) button. The first press of either button displays the set temperature. To access the overtemp feature that allows the spa to reach 106°F (41°C) follow the steps below (Figure 1).



- A. Press and hold the **WARMER** (▲) button then; 
- B. Press and hold the **JETS 1** (ⓐ) button at the same time for 2 seconds. You will see  on the LED display. To lower the temperature, press the **COOLER** (▼) button.
- C. When the overtemp has been activated, the white decimal point after the last digit will flash on and off every second as an indicator for being in the overtemp mode.

Figure 1

**Note:** Once the temperature goes below 104°F (40°C) and you would like to raise the temperature to 106°F (41°C) again, you will have to repeat the steps above.



## 9.2 Activate Jets Pumps

The **JETS 1** button activates the functions of the main 2-speed jets pump. The first press activates pump 1 in low speed, the second press activates high speed, and the third press shuts the pump off. The **JETS 2** button controls jets pump 2 which only operates in high speed. When manually activated, both pumps automatically turn off in 20 minutes.



## 9.3 Selecting Desired Massage Action

Your Sundance spa is equipped to allow you to customize the massage action you desire. Each model incorporates a massage selector that allows you to customize the massage and performance by diverting water between various jet systems. Simply turn massage selector to position A (Combo), B, or C to divert water pressure to various jet groups.

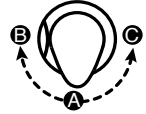

**Note:** The massage selector is designed to operate in positions A (Combo), B, and C for optimum performance. It is considered normal for sound levels within the valve to vary between positions due to the large amounts of water flowing through it. For optimum filtration benefits, leave the valve in position A when spa is covered. Select position B or C for maximum jet performance during spa use.

## 9.4 Air Controls

Certain jet systems have their own air control. Each control introduces air into the water lines that supply specific jet groups. Simply rotate any air control knob clockwise to open, or counterclockwise to close.



**Note:** To minimize heat loss, close all air controls when spa is not in use. Certain jets may not draw air while the jets pump is running in low speed; this is considered normal.

## 9.5 Multi-Colored LED Light Operation

- A. Pressing the LIGHT button activates the footwell, waterfall, and air control LED lights in sequence as follows: High - Medium - Low - Off.



Anytime the light system has been manually activated, it will automatically turn off after approximately 2 hours. If at this time you desire more light operation, simply turn the light system back on.

- B. This button offers four light modes for your enjoyment. Press the LIGHT MODE button to select your favorite lighting effect as follows:



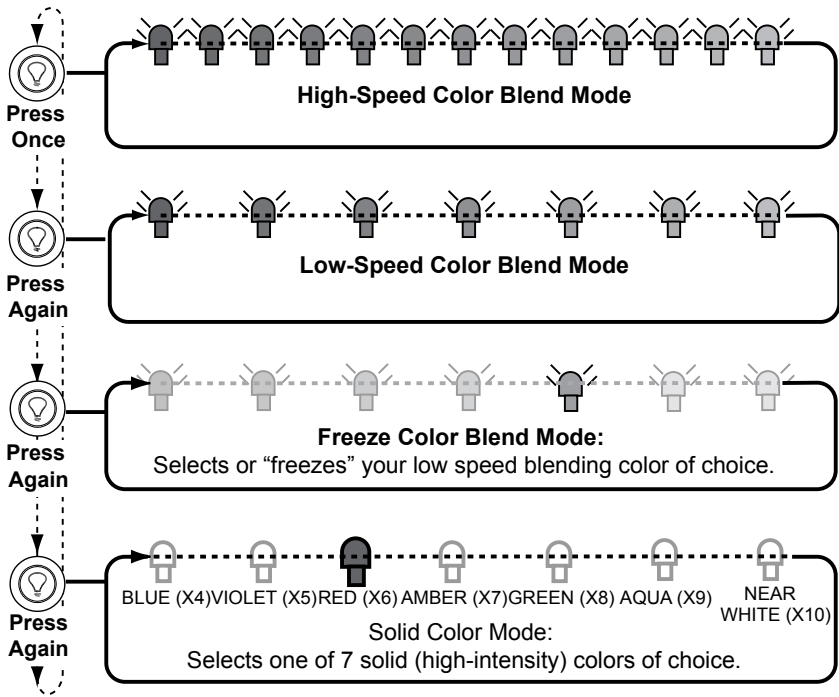

**9.6 Exterior Lights**

Your spa comes standard with eight exterior lights that create a soft illuminating light surrounding the spa. A built-in photocell sensor, activating at dusk and deactivating at dawn, controls the lights.

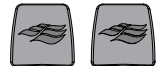

**Note:** The lights are not programmable.

### 9.7 Adjusting Fluidix Nex, Intelli-Jets, Reflex and ST Jets

The jets in your new hot tub offer the advantage of no moving parts and zero maintenance. They can also be adjusted for a high and low impact massage, providing the ultimate massage! To adjust the jets:

1. Fluidix Nex, Intelli-Jet and Reflex only: Turn outer dial (A) clockwise to increase water volume. Turn outer dial counterclockwise to decrease water volume or to shut jet off.
2. For a high impact massage, turn corresponding air control knob clockwise. For the Fluidix ST jet, this will create a straight water flow. For low impact massage, turn corresponding air control knob counterclockwise. For the Fluidix ST jet, this will create an oscillating flow. The included tool (shown) allows you to position the jet nozzle angle to your liking. This tool can also be used to aid in the opening or closing of the nozzle on Fluidix Reflex jets.
3. The Accu-Pressure jet (B) is non-adjustable.

**Note:** Always keep at least 6 adjustable jets open at all times on each jet system.



Fluidix Intelli-Jet



Fluidix Reflex

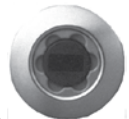

Fluidix ST Jet



Accu-Pressure

### 9.8 Waterfall Operation

The waterfall is on when jets pump 1 is running.

**Note:** The waterfall does not have an on/off control valve.



### 9.9 Optional Audio System

Spas equipped with the optional audio system offer enhanced spa enjoyment. These models include a high-quality AM/FM/CD stereo receiver with high-quality marine speakers for unsurpassed sound quality and long-life, wireless RF remote control and an MP3 adapter cable. Refer to Section 17.0 (page 50) for complete stereo operation details.



## 10.0 Automatic Filtration Cycles

Your new spa includes a circulation pump that filters the water continuously for 8 hours (default setting). The circulation pump draws water through the short side of the double-ended filter cartridge and effectively removes small debris in your spa.

**Note:** The pump is not programmable. To set a time for the circulation pump filtration cycle, simply turn power on to the spa two minutes prior to the desired time.

The control system activates a programmable “standard” or “economy” filtration/heating cycle to remove larger debris missed by the circulation pump filtration system. These cycles utilize pump #1 and the larger filter cartridge end to quickly clear “skim” the water of large debris and minimize their “bath-tub ring” effect. Apart from their filtration benefit, each mode also effects the operation of your spa’s heater. Refer to Sections 10.1 and 10.2 below for additional information.

### 10.1 Standard Filtration/Heating Modes (F0-F3)

Standard filtration/heating modes are typically selected by customers in cold climates where heat up times are extended due to lower ambient temperatures. In these modes, the set temperature regulates the water temperature. The jets pump 1, circulation pump, and heater activate as needed. After the programmed set temperature is reached, the heater turns off and the spa continues its normal operations.

### 10.2 Economy Filtration/Heating Modes (F4-F6)

Economy filtration/heating modes are typically selected by customers in warm climates where heat up times are minimized due to higher ambient temperatures. In these modes, the set temperature regulates the water temperature. The jets pump 1, circulation pump, and heater only activate while a programmed filter cycle is running (unless in summer logic; see Section 13.1, page 44).

**Note:** These modes consume less energy than standard modes F0-F3 outlined above.

### 10.3 Lock Modes (L1-L2)

These modes are designed for use during spa service or to prevent unauthorized use.

## 10.4 Selecting The Filtration/Heating Mode

Press and hold both control panel **WARMER** (▲) and **COOLER** (▼) buttons **at the same time**, then release. Then press either **WARMER** (▲) or **COOLER** (▼) button to select filtration/heating mode F0-F6 or lock modes L1-L2 outlined below. During the filtration/heating cycle the jets pump 1 low speed and circulation pump will activate.

### Standard Filtration/Heating Modes

- F0** 5 minutes of filtration per day (one 5 minute “blow-out” cycle every 24 hours to purge all plumbing lines)
- F1** 1 hour of filtration per day (one 30-minute cycle every 12 hours); this is the factory default setting.
- F2** 1.5 hours of filtration per day (one 30-minute cycle every 8 hours)
- F3** 2 hours of filtration per day (one 30-minute cycle every 6 hours)

F0

F1

F2

F3

### Economy Filtration/Heating Modes

- F4** 1 hour of filtration/heating per day (one 30-minute cycle every 12 hours)
- F5** 1.5 hours of filtration/heating per day (one 30-minute cycle every 8 hours)
- F6** 2 hours of filtration/heating per day (one 30-minute cycle every 6 hours)

F4

F5

F6

### Lock Modes

- L1** Lock Out (disables all spa functions to permit filter cleaning)
- L2** Lock Mode (disables the jets to prevent unauthorized use of spa). Filtration/heating cycle will continue to operate as programmed in this mode. The temperature display flashes when this function is enabled. Example: the “F3” filtration/heating cycle was enabled prior to choosing lock mode. The spa continues to perform the “F3” cycle until lock mode is canceled, allowing another cycle to be selected.

L1

L2

To set a time for the first filtration/heating cycle, simply turn power on to the spa two minutes prior to the desired time. Example: If you desire your first filtration/heating cycle to begin at 10:00 AM turn off power to the spa and turn it back on again at 9:58 AM.

**Note:** Start time is approximate and may vary slightly from day to day.



## 11.0 Spa Maintenance

Proper and regular maintenance of your spa will help it retain its beauty and performance. Your authorized Sundance dealer can supply you with all the information, supplies and accessory products you will need to accomplish this.



### **DANGER: RISK OF SEVERE INJURY OR DROWNING BY ENTRAPMENT!**

- Keep hair, loose articles of clothing or hanging jewelry away from suction fittings, rotating jets or other moving components to avoid entrapment that could lead to drowning or severe injury.
- Never use the spa unless all suction guards, filter, filter lid, or skimmer assembly are installed to prevent body and/or hair entrapment.
- Never operate or use the spa if the filter, filter lid, or skimmer assembly are broken or any part of the skimmer assembly is missing. Please contact your dealer or nearest service center for service.
- The suction fittings and suction covers in this spa are sized to match the specific water flow created by the pump(s). If it is necessary to replace the suction fittings, suction covers or pump(s), be sure that the flow rates are compatible and are in compliance with the VGB Safety Act page 2.
- Never replace a suction fitting or suction cover with one rated less than the flow rate marked on the original suction fitting. Using improper suction fittings or suction covers can create a body or hair suction entrapment hazard that may lead to drowning or severe injury.
- Owners must alert all spa users to the potential risk of Hair, Limb, Body, Evisceration (disembowelment), and Mechanical Entrapment, page 6.

### 11.1 Cleaning The Filter

Your new spa is equipped with an exclusive MicroClean™ 2-stage filter cartridge located under the filter lid. Fine debris are filtered by the circulation pump drawing water through the ultra-fine (stage 2) cartridge. Larger debris are filtered by the main 2-speed pump drawing water through the (stage 1) polyester mesh (pleated) cartridge during normal operation and during each filtration/heating cycle. Combined, both filter halves work together to give you unsurpassed water quality by trapping suspended particles on their outer surface.

**Note:** To ensure optimum performance, clean and reuse the stage 1 cartridge once a month and replace the stage 2 cartridge every 3 months, or as needed.

**⚠ DANGER: TURN POWER TO SPA OFF! TO DECREASE RISK OF DEATH, DROWNING, OR ENTRAPMENT, NEVER OPERATE SPA WHEN FILTER IS NOT PROPERLY INSTALLED OR IF SKIMMER ASSEMBLY IS DAMAGED OR ALTERED!**

Refer to the filter cleaning/replacement procedure:

**A**



**TURN POWER TO HOT TUB OFF!**



**B**

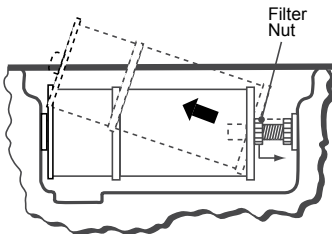

Loosen filter nut to provide clearance, then remove filter assembly.

**C**

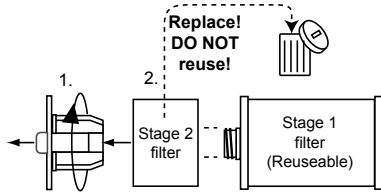

1. Rotate stage 2 retainer counterclockwise to release, then separate filter assembly.
2. Replace (throw-away) stage 2 filter after 3 months use or as needed. **DO NOT REUSE!**

**D**

Note: Remove and clean the Stage 1 filter cartridge once a month.

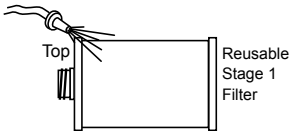

Rinse debris from all filter pleats using a garden hose and high-pressure nozzle. Start at top and work downward to face. Repeat process until all filter pleats are clean.

**E**

Note: The Stage 2 filter cartridge cannot be cleaned and must be (thrown out) replaced every 3 months, or as needed.

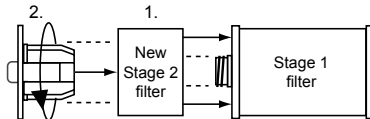

1. Install new stage 2 filter onto clean stage 1 filter.
2. Insert retainer into stage 2 filter and rotate clockwise to assembly. **DO NOT OVERTIGHTEN RETAINER (FINGER TIGHT ONLY!)**

**F**

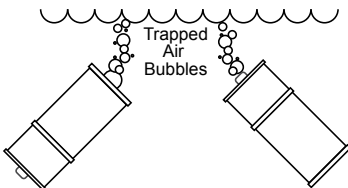

Submerge assembled filter in spa and tilt each end upward to remove trapped air bubbles from inside each filter cavity.

**G**

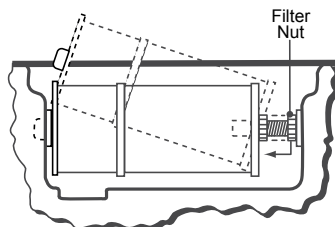

1. Install filter assembly, then tighten filter nut so it just touches filter face. **DO NOT OVERTIGHTEN!**
2. Turn power to hot tub back on.



Periodically, the polyester mesh (pleated) filter will need a more thorough cleaning to remove imbedded oils and minerals. For this, we suggest cleaning as illustrated above (step D), followed by soaking the filter overnight in a plastic container filled with a solution of water and a specially formulated filter cleanser available from your Sundance dealer.

**CAUTION: RISK OF PRODUCT DAMAGE!**

- Never scrub the polyester mesh filter cartridge with a brush as this will cause the polyester mesh to wear out and come apart.
- Never let the spa pump run or have a filter cycle come on without a filter cartridge in the skimmer compartment. Running the spa without a filter cartridge may permit debris to enter the spa plumbing and void the warranty!

The average life expectancy of the polyester mesh filter cartridge is approximately two years with proper care and water quality maintenance. The smaller stage 2 filter cannot be cleaned and must be replaced (thrown-out) every 3 months, or as needed. **DO NOT** reuse this cartridge! Attempts to reuse this cartridge will reintroduce debris back into your spa! Replacement cartridges may be purchased from your Sundance dealer.

## 11.2 Draining And Refilling

About every 3 months, you will want to replace the spa's water. The frequency depends on a number of variables including the amount of use and attention paid to water quality maintenance. You will know it is time for a change when you cannot control sudsing and/or you can no longer get the normal feel or sparkle to the water even though the key water balance measurements are all within the proper parameters.



**CAUTION! READ THIS BEFORE DRAINING:** To prevent damage to the spa's components, turn off power to the spa at the circuit breaker before draining it. Do not turn the power back on until your spa has been refilled. There are certain precautions to keep in mind when draining your spa. If it is extremely cold, and the spa is outdoors, freezing could occur in the lines or the equipment (see "Winterizing", Section 11.7 page 40). On the other hand, if it is hot outdoors, do not leave the spa's surface exposed to direct sunlight for long periods.

**Draining Procedures:**

1. Turn off power to spa at breaker.
2. Locate the 3" gray drain valve cap on side of the spa cabinet. Unscrew drain valve cap to expose the underlying male garden hose fitting (Fig. G-I).
3. Attach female garden hose end to drain fitting and route opposite end of garden hose away from spa (Fig. H).
4. Pull outward on garden hose end at drain connection (approx. 3/8") to open drain valve and release water from spa (Fig. I). Water drains at approximately 3 gallons per minute.
5. After spa has drained, close drain valve by pushing inward on garden hose end at drain connection until you feel it bottom out. Remove garden hose and install gray drain cap before refilling spa.

Figure G

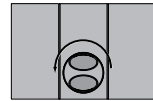

Figure H

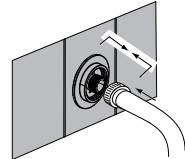
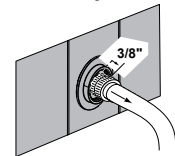

Figure I



**Note:** The gray drain cap cannot be installed until the drain valve is closed. Refer to "Spa Fill Up Procedure" (page 15) for recommended filling instructions.

**11.3 Pillow Care**

Remove and clean the headrest pillows as needed with soapy water using a cloth or soft-bristle brush. Always remove the pillows when adding chemical shock treatment to the spa water. The pillows can be returned to the spa when the sanitizer reading drops below 4.0 ppm.



**Pillow Removal/Cleaning Procedure**

1

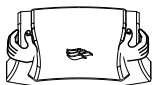

Place both hands on pillow with thumbs as shown.

2

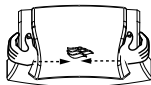

Press inward with thumbs to curl pillow lip inward so you can grab it with fingertips.

3



Flex pillow lip inward 2-3" to get a good grip on the ends.

4

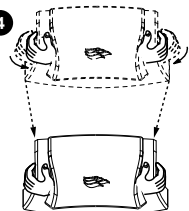

Gently pull outward on pillow to release mounting stud from receptacle on spa shell.

5

Wash pillow(s) in a mild detergent soap and warm water solution. Never machine wash your pillows or attempt to clean them with a non-approved vinyl cleaning agent!

6

To reinstall pillows: Simply align pillow over mounting stud receptacle, then gently push inward to snap in place.

## 11.4 Cleaning The Spa Interior

To preserve the sheen of your spa's surface, it is crucial that you avoid using abrasive cleaners or cleaners which have adverse chemical effect on the surface. If you are not certain as to the suitability of a particular cleanser, consult your authorized Sundance dealer. Regardless of the cleanser used, use extreme care to assure that no soap residue is left on the surface. This could cause severe sudsing when the spa is refilled.

## 11.5 Maintaining the Cover

Using the Sundance insulating spa cover anytime the spa is not in use will significantly reduce your operating costs, heat-up time and maintenance requirements. To prolong the life of the cover, handle it with care and clean it regularly. Below are the care instructions.

### A. Standard Vinyl cover maintenance

To Clean and Condition the Vinyl Cover:

1. Use a garden hose to loosen debris and dirt.
2. Using a large sponge or a soft bristle brush, use diluted or mild soap and scrub the vinyl top. Rinse clean and do not allow soap to dry on cover. Do not use soap on the underside of the cover.
3. Please check with your Sundance Spa Dealer for recommended cover care and conditioning products. Condition using non-petroleum based conditioners to keep the vinyl supple and threads/stitching from drying out. Do not use solvents, abrasive cleaners or strong detergents. Do not use products that contain silicone or alcohol.

### B. Sunbrella® cover maintenance

To Clean and Condition the Sunbrella Cover:

1. Brush off dirt, leaves and any loose debris.
2. Thoroughly hose down the cover.
3. Using a large sponge or a soft bristle brush, use diluted or mild soap (such as woolite or dreft, no detergents) and scrub the cover. Allow the solution to soak in.
4. Rinse clean and do not allow soap to dry on cover. Continue to rinse until all the soap solution is removed. Do not use soap on the underside of the cover. The fabric dries quickly allow it to air. Do not apply heat or machine dry.
5. Retreating the fabric, using 303 High Tech Fabric Guard™, after cleaning is highly recommended. Follow the instructions from the manufacturer.
6. Additional cleaning and care information may be found at [www.sunbrella.com](http://www.sunbrella.com)

**NOTE:** Do not use solvents, abrasive cleaners or detergents. Do not use products that contain silicone or alcohol.

**C. Additional Care and Maintenance Instructions:**

1. Debris can accumulate on the spa cover. Removal of snow or other debris will help to avoid breakage of the foam cores.
2. Be sure to lock the cover straps to secure the cover from unwanted or accidental entry.
3. Do not place heavy objects on the cover.
4. Do not walk, sit or stand on the cover.
5. Do not drag or use the flaps/skirt or the cover lock straps to remove the cover.
6. Use only recommended cover lift systems.
7. Use only chemicals and cleaners recommended by Sundance Spas.
8. Remember to keep spa covered when not in use. Maintaining proper water levels assures efficient operation and efficient electrical usage.
9. Do not expose your spa to the sun for extended periods of time as UV rays can damage the interior surface.
10. Use caution when removing cover. Before removing cover, assure all locks have been released to avoid lock breakage and or cover strap damage.

**11.6 Maintaining The Synthetic Cabinet**

Your new spa's synthetic cabinet requires little or no maintenance of any kind. To clean, simply wipe cabinet with a clean towel and mild soap solution.



**CAUTION: Never spray cabinet with a garden hose for any reason since this action may induce an electrical short in the spa's electrical equipment.**

**11.7 Winterizing**

Your Sundance spa is designed to automatically protect itself against freezing when operating properly. During periods of severe freezing temperatures, you should check periodically to be certain that the electrical supply to the spa has not been interrupted. In extreme, bitter cold weather less than -20°F (-29°C), choose the F3 "Standard" filtration/heating mode to prevent freezing (page 33).

If you do not intend to use your spa, or if there is a prolonged power outage during periods of severe freezing temperatures, **it is important that all water be removed from the spa and equipment to protect against damage from freezing.**

Expert winterization of your spa is highly recommended, contact your authorized Sundance dealer. In emergency situations, damage can be minimized by taking the following steps:

**CAUTION: TURN OFF POWER TO HOT TUB!**

1. Follow the directions on pages 37-38 for draining the spa.
2. Turn the massage/diverter selector(s) into the middle combo position to allow the water in the plumbing lines to drain, see page 29.
3. As the water level drops below the seats, use whatever means necessary to get the water out of the recessed seating areas and into the footwell, such as a wet/dry vacuum.
4. When the water level ceases to drop, use whatever means available to remove any remaining water from the footwell, such as a wet/dry vacuum.
5. Remove the equipment-side cabinet panels and locate the drain plugs in the front of the pump(s) (Figure A, page 14). Remove these plugs to allow the water to drain out of the pumps and heater.

**Note:** Approximately one to two gallons will be released during this procedure. Use a wet/dry vacuum or other means to keep this from flooding the equipment compartment. Replace the drain plugs.

6. Loosen the hose clamp on the circulation pump intake behind the control box (Figure A, page 14) and pull the hose off (twist hose back and forth while pulling outward). Tip hose down and allow to drain, then reinstall hose and clamp.
7. Re-install cabinet side panels and cover spa so that no casual moisture can enter into it.

Consult your authorized Sundance dealer if you have any questions regarding winter use or winterizing.

### **11.8 Restarting Your Spa in Cold Weather**

If you want to start up your spa after it has sat empty for a time in freezing temperatures, be aware that the water remaining in certain sections of the piping may still be frozen. This situation will block water flow preventing the spa from operating properly and possibly damaging the equipment. We recommend you consult your dealer for guidance before attempting to re-start your spa under these conditions.

### **11.9 Top Rail Care And Maintenance**

Parts should be cleaned with soap and water and a non-abrasive cleaning pad. More stubborn stains can be cleaned with a water based cleaning solution or cleaners specified for vinyl surfaces. Solvent based

or aggressive degreasing cleaners should not be used. Small scratches or nicks resulting in the lighter colored sub surface being exposed can be made less obvious by using common furniture repair markers. These are generally available in packs with several wood tones from which a close match can be selected to the color of the scratched part.

## 12.0 Water Quality Maintenance

To decrease the risk of contracting a waterborne illness (e.g. an infection, bacteria or virus) and/or respiratory ailments, maintain water quality within specified limits. This will enhance your enjoyment and prolong the life of the hot tub's equipment. Doing so requires regular attention because the water chemistry involved is a balance of several factors. Procrastination in regard to water maintenance will result in poor and potentially unhealthful conditions for soaking and even damage to your hot tub investment. For specific guidance on maintaining water quality, consult your Authorized Sundance Spas dealer who can recommend appropriate chemical products for sanitizing and maintaining your hot tub.



### **WARNING: FAILURE TO MAINTAIN WATER QUALITY WILL:**

- Increase risk of contracting a waterborne illness (e.g. an infection bacteria or virus) and/or respiratory ailments.
- Damage the equipment, components and spa shell, which are not covered under the hot tub's warranty.

**CAUTION:** Never store hot tub chemicals inside the hot tub's equipment bay. The equipment bay may reach elevated temperatures, this is where high voltage electronic devices are located. This area is not intended for storage of any kind.

## 12.1 pH Control

pH is a measure of relative acidity or alkalinity of water and is measured on a scale of 0 to 14. The midpoint of 7 is said to be neutral, above which is alkaline and below which is acidic. In spa water, it is very important to maintain a slightly alkaline condition of 7.4 to 7.6 pH. Problems become proportionately severe the further outside of this range the water gets. A low pH will be corrosive to metals in the spa equipment. A high pH will cause minerals to deposit on the interior surface (scaling). In addition, the ability of the sanitation agents to keep the spa clean is severely affected as the pH moves beyond the ideal range. That is why almost all spa water test kits contain a measure for pH as well as sanitizer.

## 12.2 Sanitizing

To destroy bacteria and organic compounds in the spa water, a sanitizer must be used regularly. Chlorine and bromine are the two most popular sanitizers used to date. SunPurity™ mineral cartridge designed specifically for your hot tub. Many other additives are available for your spa. Some are necessary to compensate for out-of-balance water; some aid in cosmetic water treatment and others simply alter the feel or smell of the water. Your authorized Sundance dealer can advise you on the use of these additives. When adding spa shock (chlorine or non-chlorine) or pH balancing chemicals activate the jets pump(s) and leave the spa cover open for a minimum of 20 minutes. By doing this you will allow excessive chemical vapors to exit the spa, protecting pillows and plastic knobs from chemical attack.



**WARNING: RISK OF PERSONAL INJURY, DROWNING OR ENTRAPMENT!**

Never leave your hot tub unattended for any reason while the cover is open and accessible, especially to small children and animals!

**CAUTION: RISK OF PERSONAL INJURY OR SPA DAMAGE!**

Never add chlorine tablets (trichlor) or acid to your hot tub for any reason! These chemical may damage components within your hot tub, burn or irritate your skin, create a rash, and void the manufacturer warranty for your spa.

## 12.3 CD Ozone Water Maintenance System

This system is optional on North American models and standard equipment on export 50 Hz spa models. If your spa is equipped with the optional Sundance CD Ozone water purification system you will find that your water stays fresh and clear with significantly less chemical sanitizer usage. You will also probably be able to go longer between complete spa drainings.

**Note:** The ozone only runs when the circulation pump is running and shuts off when either jets pump is manually activated during spa use. The ozone will remain off for 5 minutes after both jets pumps time out or are manually turned off, then resume operation only if the circulation pump continues to run.

### 13.0 Error Conditions/Error Messages

There are a number of unique functions designed into your spa to protect it from damage and/or aid in troubleshooting. Refer to Sections 13.1-13.8 below for a listing of all possible error messages and their meanings.

#### 13.1 Summer Logic

When the actual spa water temperature reaches up to 2°F (1°C) above the set temperature, the spa goes into “summer logic”. The circulation pump will turn off automatically, if running, to avoid adding additional heat to the water, eventually creating an overheat condition. This setting is not user-programmable.



**Note:** The summer logic does not take effect until the spa water temperature reaches 95°F (35°C). This condition is more likely in excessively hot weather. Remember, the spa’s ability to cool is directly affected by the ambient temperature. An excessively hot ambient temperature may prevent the spa from cooling down because it’s fully insulated construction is designed to retain heat and to minimize operating costs.

#### 13.2 Overheat Condition



**WARNING: RISK OF HYPERTHERMIA (OVER-HEATING) CAUSING SEVERE INJURY, BURNS, OR WELTS.**

**DO NOT ENTER SPA WATER!** Water is too hot. Overheat protection. Heater is deactivated. Spa water temperature is above acceptable limits. When the actual water temperature is approximately 2°F (1°C) above the set temperature, the circulation pump will stop operating to reduce (frictional) heating. To correct condition, remove spa cover to speed cooling. **(CAUTION! Never leave spa uncovered when children are present!)** If condition persists, contact your authorized Sundance dealer.

#### 13.3 Panel displays SN1

Open sensor (heater is disabled) or shorted sensor (spa is deactivated). The high-limit temperature sensor is not functioning. Your authorized dealer must repair this.



### 13.4 Panel displays SN2

Open or shorted sensor (heater disabled). The temperature sensor is not functioning. Your authorized dealer must repair this.

### 13.5 Panel displays FL1 or FL2

A flashing "FL1" display means the flow switch is malfunctioning open, the circulation pump's filter cartridge is excessively dirty, or an "air lock" condition has occurred at the circulation pump intake. A flashing "FL2" display means the flow switch is malfunctioning closed.

- This error will cause the heater to deactivate. The main pump #1 may also deactivate.
- This problem is caused by an interruption in water flow from an excessively dirty filter cartridge, an "air lock" condition at the pump intake, or by a malfunctioning flow switch.

To Correct Condition:

1. Verify water level is above all jets and below lowest pillow. Add water if necessary.
2. Check for clogged/excessively dirty filter cartridge. See Section 11.1 (pages 35-36).
3. Purge "air lock" from circulation pump intake by removing the filter cartridge. Hold your garden hose over the filter wall fitting (with grate) using a rag as a seal around hose end, then ask a helper to turn on water for 30 seconds, then turn off. Reinstall filter cartridge and check spa. See Section 11.1 (pages 35-36).
4. If the circulation pump is not running, turn power off at the main breaker, then turn power back on. This will reset the circulation pump priming cycle. Once the pump is primed, the error should clear.
5. If problem persists, contact your authorized dealer.



### 13.6 Panel displays COL

Cool Condition - Temperature has dropped 20°F (11°C) below the current set temperature. The pump and heater have been activated to bring the temperature to within 15°F (8°C) of the set temperature. No corrective action is required (page 33).

**Note:** During cold periods, you may consider increasing the number of filtration cycles.

### 13.7 Panel displays ICE

Freeze Protection - A potential freeze condition has been detected. No action is required. Main pump will operate to circulate warm water through the plumbing until the spa is out of danger.

### 13.8 Panel displays - - -



**WARNING: RISK OF HYPERTHERMIA (OVER-HEATING)  
CAUSING SEVERE INJURY, BURNS, OR WELTS.**

**DO NOT ENTER SPA WATER!** The safety "Watchdog" software has been triggered and the spa is deactivated. A problem has been detected which could cause damage to the spa or its components. Contact your authorized dealer.



## 14.0 Troubleshooting Procedures

In the event your Sundance spa is not working the way it should, please first review all the installation and operating instructions in this manual and check the message on the panel display. If you are still not satisfied it is working properly, please follow the appropriate troubleshooting instructions.

**Note:** If any of the supply cords to the accessories are damaged, they must be replaced by authorized service personnel.

### 14.1 None of the Components Operate (e.g. Pump, Light)

Check the following:

1. Is there power to the spa?
2. Is the household circuit breaker tripped?
3. Call your authorized dealer.

### 14.2 Pump Does Not Operate but Light Does

Press the JETS 1 Button:

1. If no water movement is detected, make sure power is going to the spa and check the water level. If it does not solve the problem, contact your authorized Sundance dealer.
2. The main pump operates but no water flows to jets. Pump may not be properly primed. This can happen after the spa is drained and refilled. Press the JETS 1 button several times, never leaving the motor on for more than 5 to 10 seconds at a time. Turn power off and let the air out by loosening the cap on the massage selector and/or removing the filter. Make certain you tighten the massage selector cap and/or reinstall the filter before turning on spa power and restarting the pump.

### 14.3 Poor Jet Action

1. Press the JETS 1 button to make certain the pump #1 is on.
2. Rotate the air control clockwise to the "on" position.
3. Check for dirty filter. Clean, if necessary.
4. Make sure jets are all the way open.

### 14.4 Water is Too Hot

Reduce thermostat setting so the heater turns off.

### 14.5 No Heat

1. Check thermostat setting.
2. Keep the spa cover in place while heating.
3. Check the settings to see if your spa is in economy filtration/heating mode (pages 32-33).

Should checking the above steps fail to correct the problem, please call your dealer so that they may arrange service. We build the best spas in the industry. Nonetheless, we are always striving to improve the quality and features of our products. Your input as a Sundance spa owner is a cherished part of this process. If you have any comments or suggestions, or if you wish to be informed on any new products for your spa, please write to us.

**CONGRATULATIONS** on your good taste and welcome to the happiest and most relaxed family in the world!

## 15.0 North American Circuit Diagram

This wiring diagram is used for all North American 240 VAC (60 Hz) dedicated power models.

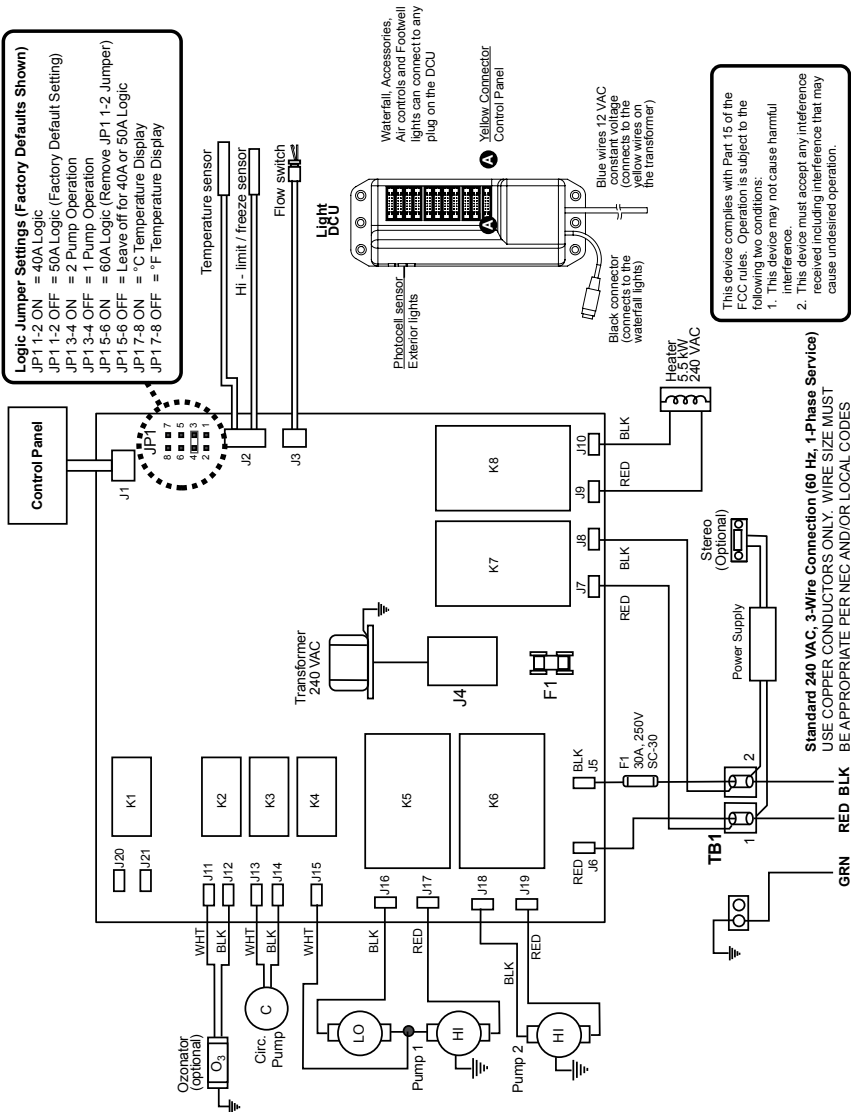

## 16.0 Export Circuit Diagram

This wiring diagram is used for Export 230 VAC (50 Hz) dedicated power models.

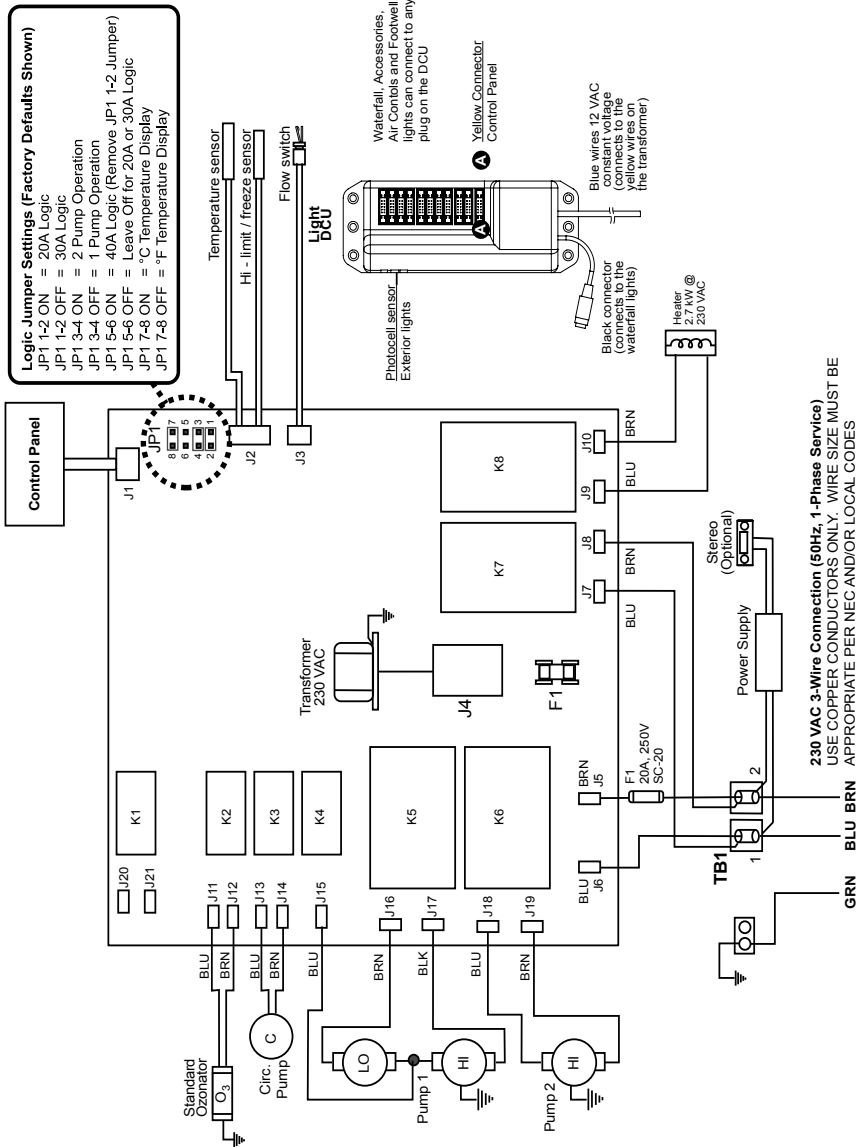

## 17.0 Optional Stereo Receiver Functions

### 17.1 Stereo Receiver Control Functions

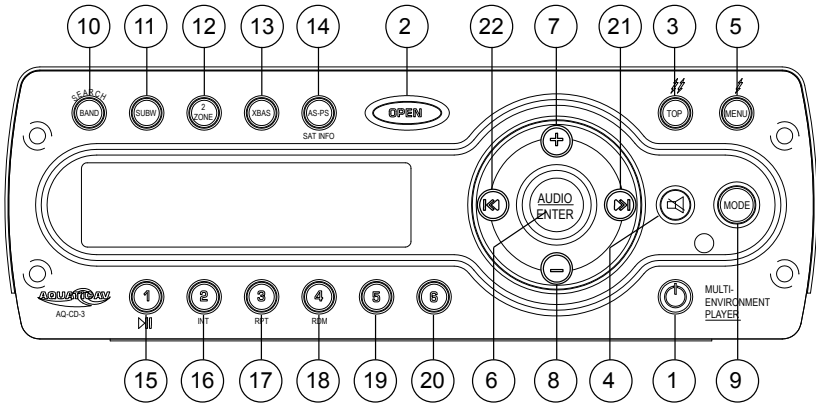



#### Models equipped with the stereo option only:

To start enjoying your new Stereo Receiver, please read the following operation instructions in their entirety.

- Power Button:** Press PWR (Power) to turn deck on or off.
- Open Button:** Press Open to flip down the front access panel for CD access. Gently insert CD into slot (DO NOT FORCE!) Make sure to close the front panel to prevent damage to the unit.
  - Eject Button (Not Illustrated): After releasing the front panel, press the Eject button located to the left of CD slot to eject the CD. The unit does not have to be on to eject the CD.
  - Reset button (Not Illustrated): After releasing the front panel, use a pencil or any nonmetallic object to press and hold the reset button for five seconds to reset the main unit and the unit will return to the factory default settings.

**Note:** Never insert a wet or moist CD since it may damage the mechanism and void the manufacturer warranty.

- Top Button:** Has no function.
- Mute Button:** Press Mute to mute audio output. The word Mute flashes on the display panel. Press again to return to previous volume level.

5. **Menu Function List Button:** Press Menu to navigate through the list of stereo performance functions. Steps to access menu items:
  - A. To access the MENU press the Menu button < 3 seconds.
  - B. "MENU" will be displayed for 2 seconds, and then "CONTRAST" will appear on the display.
  - C. To navigate through the menus use the (  ) or (  ) buttons or press the MENU button repeatedly.
  - D. To adjust the selected menu item, press the VOLUME Up (7) or Down (8) buttons.
  - E. After the selected menu item(s) has been changed and no other buttons have been pressed within the 5 second time-out, the unit will resume to the previous operation.
  - **Contrast:** "CONTRAST 5" will be displayed by default. The user now has 5 seconds to press the VOLUME Up or Down buttons to adjust from 0 – 10.
  - **Dimmer:** The dimmer feature of the display is set to "DIMMER High" by default. Use the Volume Up or Down buttons to adjust the Dimmer level between High or Low.
  - **Distant/Local:** "Distant" is the default setting. User now has 5 seconds to adjust with the VOLUME Up or Down buttons from "Distant" (a broader range of signals) to "Local" (only strong local stations). This feature is used to designate the strength of the signals at which the radio will stop during automatic tuning.
  - **Area:** "USA" is the default setting. User now has 5 seconds to select "USA", "LATIN", "EUROPE" or "ORIT" by pressing the VOLUME Up or Down buttons.

**Note:** "LATIN" and "ORIT" are not used.

  - **Interamp On/Off:** Feature is not used.
  - **Programmable Turn-on Volume:** "VOL PGM 12" is the default setting. User now has 5 seconds use the VOLUME Up or Down buttons to program the turn on volume.
  - **Beep Tone:** "ON" is the default setting. User now has 5 seconds to adjust by pressing the VOLUME Up or Down buttons from "ON" to "OFF".

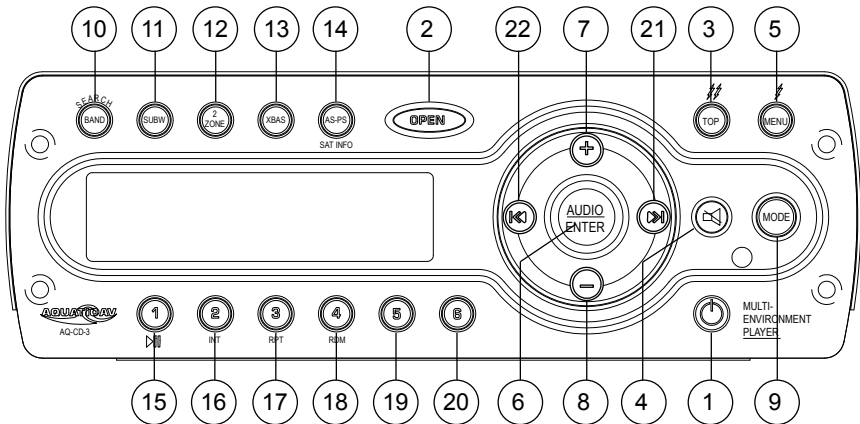

- 6. Audio/Enter Button:** Press Audio/Enter to navigate through the stereo sound functions. Short press “AUDIO” button to access the audio menu. User can navigate thru the audio menu items by pressing the “AUDIO” button repeatedly, or by pressing the Tuning Up (21) or Tuning Down Button (22). Once the desired menu item appears on the display, adjust that option by using the Volume Up (7) or Down button (8) within 5 seconds. The unit will automatically exit the Audio Menu after five seconds of inactivity.

  - VOLUME (Volume Level):** User has 5 seconds to use the Volume button to adjust the desire volume level, the volume level will be shown on the LCD display ranging from 00 (lowest) to 46 (highest).
  - SUBWOOFER (Sub-woofer Level):** User has 5 seconds to use the Volume Up or Down button to adjust the Sub-woofer lever from “00” to “12”.  
**Note:** The Sub-woofer level control is only applicable if the unit is equipped with the optional subwoofer line out, and only if the unit is connected to an optional sub-woofer speaker. The Sub-woofer level control option will only appear in the Audio Menu if the “Sub-woofer” function is activated “ON” by pressing the “Sub-W” button on control panel.
  - SUB-W LPF (Sub-woofer Low Pass Filter):** User has 5 seconds to use the Volume Up or Down button to select the 4 different Low Pass filters Flat, 80 Hz, 120 Hz or 160 Hz.  
**Note:** The Sub-woofer LPF control is only applicable if the unit is equipped with the optional subwoofer line out, and only if the unit is connected to an optional sub-woofer speaker. The Sub-woofer LPF option will only appear in the Audio Menu if the “Sub-woofer” function is activated by pressing the “Sub-W” button on control panel.
  - iX-BASS (iX-Bass Level):** User has 5 seconds to use the Volume Up or Down button to select the 3 different Bass Boost level: Low, Mid, or High.



- **BASS (Bass Level):** User has 5 seconds to use the Volume Up or Down button to adjust the desired Bass level range from -6 to +6.
- **BASS -CFQ (Bass Center Frequency):** User has 5 seconds to use the Volume Up or Down button to adjust the desired Bass Center Frequency to 60 Hz, 80 Hz, 100 Hz, or 200 Hz.
- **BASS-Q: (Bass Quality Factor):** User has 5 seconds to use the Volume Up or Down button to adjust the desired Bass Quality Factor to 2N, 1N, 1W or 2W. See Figure 1.

Shows the Bass Quality factor (Curve characteristics) of each step

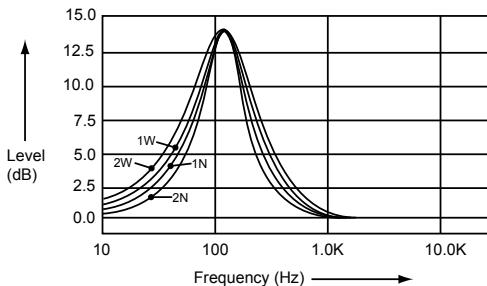

Figure 1

- **MIDDLE (Middle Level):** User has 5 seconds to use the Volume Up or Down button to adjust the desired Middle level range from -6 to +6.
- **MID-CFQ (Middle Center Frequency):** User has 5 seconds to use the Volume Up or Down button to adjust the desired Middle Range Center Frequency to 500 Hz, 1 KHz, 1.5 KHz, or 2.5 KHz.
- **MIDDLE-Q (Middle Quality Factor):** User has 5 seconds to use the Volume Up or Down button to adjust the desired Middle Quality Factor to 2N, 1N, 1W or 2W. See Figure 2.

Shows the Middle Quality factor (Curve characteristics) of each step

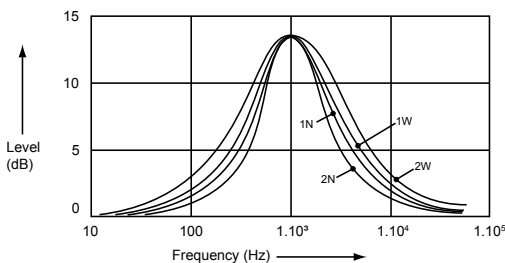
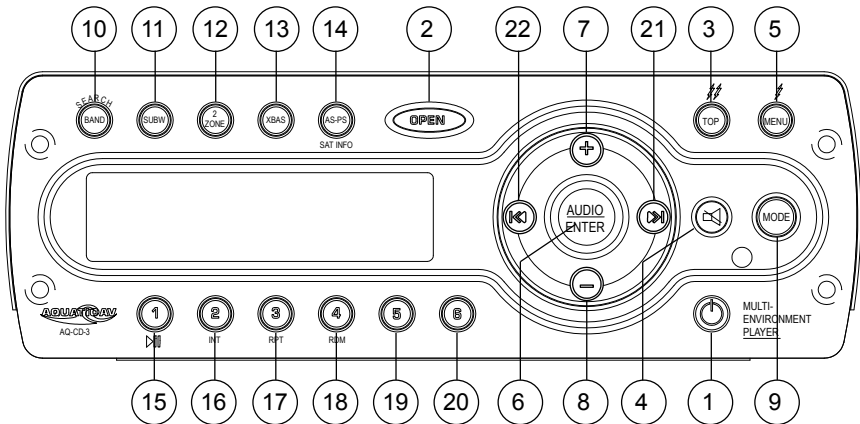
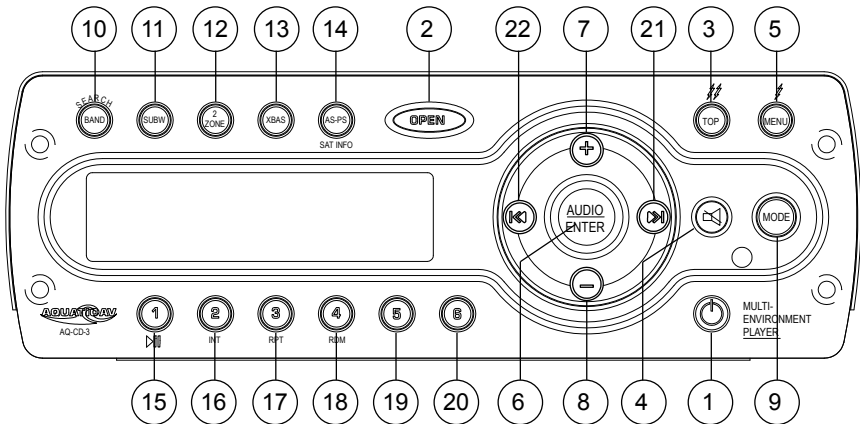

Figure 2



- **TREBLE (Treble Level):** User has 5 seconds to use the Volume Up or Down button to adjust the desired Treble level range from -6 to +6.
  - **TRE-CFQ (Treble Center Frequency):** User has 5 seconds to use the Volume Up or Down button to adjust the desired Treble center frequency to 10 KHz, 12.5 KHz, 15 KHz, or 17.5 KHz.
  - **BALANCE:** User has 5 seconds to use the Volume Up or Down button to adjust the Balance between the right and left speakers from R12 (full right) to L12 (full left). "C00" represents an equal balance between the right and left speakers.
  - **FADER:** User has 5 seconds to use Volume Up or Down button to adjust the Fader between the front and rear speakers from R12 (full rear) to F12 (full front). "C00" represents an equal balance between the front and rear speakers.
7. **Volume Up Button:** Press + (Volume Up) to increase the volume level. The volume level is shown on the display panel, ranging from 0 to 46.
  8. **Volume Down Button:** Press - (Volume Down) to decrease the volume level. The volume level is shown on the display panel, ranging from 46 to 0.
  9. **Mode Button:** Short press the Mode button to change input from XM Tuner (not used), CD, AUX, or Tuner. The mode selection is shown on the display panel.
  10. **Band Button:** Press Band to change between FM1, FM2, FM3, AM1, or AM2 bands.

11. **Sub-Woofers (SUBW) Button:** Press the SUB-W button to activate the Sub-woofer function On, and “Sub-woofer” will appear on the LCD display for 3 seconds. Press the SUB-W button again to turn off the Sub-woofer function.
12. **2 Zone Button:** The feature is not used.
13. **iX-Bass Button (XBAS) Button:** Press the iX-BASS button to turn on the iX-BASS function, and “iX-BASS” will appear in the LCD display for 3 seconds. Press the iX-BASS button again to turn off the iX-Bass function.
14. **AS/PS (Automatically Store/Preset Scan) Button:** While in seek mode the stereo unit will automatically select 6 strong stations and store them in the current band. Select a band (if needed).
  - **Preset Scan:** Scan stations stored in the current band. Select a band, press AS/PS button for less than 3 seconds. The unit will pause for ten seconds at each preset station. Press AS/PS button again to stop scanning when the desired station is reached.
  - **Stereo:** The unit will automatically pick up a stereo signal when available. When in stereo mode, the ST icon appears in the display. When no stereo signal is available, the unit will automatically revert to mono operation, and no icon will be displayed.
15. **Preset 1/Pause Play Button:** In Tuner mode, any station can be stored as preset 1 by pressing and holding this button for 2 seconds, after the desired station is selected. To recall the station preset, simply press and release this button. In CD mode, pressing this button will pause or play the CD. When inserting a CD make sure the label side is facing up.
16. **Preset 2/INT Button:** In Tuner mode, any station can be stored as preset 2 by simply pressing and holding this button for 2 seconds, after the desired station is selected. To recall the station preset, simply press and release this button. In CD mode, pressing this button will preview each song on the disc for about 10 seconds. Press again to turn off this feature or once the desired track is reached.
17. **Preset 3/RPT Button:** In Tuner mode, any station can be stored as preset 3 by simply pressing and holding this button for several seconds, after the desired station is selected. To recall the station preset, simply press and release this button. In CD mode, pressing this button will play a song repeatedly. Press again to turn off this feature.



18. **Preset 4/RDM Button:** In Tuner mode, any station can be stored as preset 4 by simply pressing and holding this button for 2 seconds, after the desired station is selected. To recall the station preset, simply press and release this button. In CD mode, press this button to randomly play song tracks. Press again to turn off this feature.
19. **Preset 5/DN Button:** In Tuner mode, any station can be stored as preset 5 by simply pressing and holding this button for 2 seconds, after the desired station is selected. To recall the station preset, simply press and release this button. In CD mode, this button will browse the folders on CD-R and CD-RW discs.
20. **Preset 6/UP Button:** In Tuner mode, any station can be stored as preset 6 by simply pressing and holding this button for 2 seconds, after the desired station is selected. To recall the station preset, simply press and release this button. In CD mode, this button will browse the folders on CD-R and CD-RW discs.
21. **Tuning Up Button:** Press and hold Track Up for more than 3 seconds to manually adjust station frequency up, Auto Seek is shown on the display panel. Short press Track Up to scan/seek for next higher station, Manual Seek is shown on the display panel. Scan mode stops as soon as a strong station is found. In CD mode, pressing this button will advance the CD up to the next track, the track number is shown on the display panel. Simply press and hold the button to fast forward through a track(s). CD play starts when the button is released.
22. **Tuning Down Button:** Press and hold Track Down for more than 3 seconds to manually adjust station frequency down. Press Track Down to scan/seek for next lower station. Scan mode stops as soon as a strong station is found. In CD mode, pressing this button will advance the CD down to the previous track, the track number is shown on the display panel. Simply press and hold the button to rewind through a track. CD play starts when the button is released.

23. **Displaying information:** When a retail music CD is inserted, the disc will begin to play. The following information will be displayed: CD track no./Playtime.

When a CD containing MP3 files is inserted, the display will change modes as follows:

- Track no./Playtime
- Folder name
- File name
- Song name
- Artist's name
- Album name

The system can only display the first 8 letters of ID3 tags. If the recorded information is longer than 8 letters, text will scroll to the left once, then the 8 first letters will be displayed. If specific info has not been recorded on an MP3 disc, NO FOLD, NO TRK, NO TLT, NO ALBM, NO ART will display.

24. **Playback Order of CD with MP3 Files:**

- A directory that does not include an MP3 file is skipped.
- We recommend that you make no more than two levels for each disc.
- Maximum number of folders: 255
- Maximum number of folder levels: 8
- Maximum number of characters for MP3 file name and folder name: 32
- Sampling frequency: (32 kHz, 44.1 kHz for WMA) and (16 kHz, 22.05 kHz, 24 kHz, 32 kHz, 44.1 kHz, 48kHz for MP3)
- Bit rates: 32-320 Kbps
- MP3 decoding format: MPEG 1, 2 & 2.5 Audio Layer 3
- Folder names and file names can be displayed with up to 11 characters.
- The characters A-Z, 0-9 can be displayed on this unit, other characters may not be displayed correctly.
- ID3 tag is supported.

25. **Reading MP3 files from a disc:** When a disc containing MP3 data is loaded, the unit checks all the data on the disc. If the disc contains numerous folders with many levels or non-MP3/WMA files, it takes a longer time to start playback. In addition, it may take time for the unit to move to the next MP3 file and the fast forward function may not be performed smoothly. Loading such a media may produce loud noise and cause damage to the speakers. When selected to play, files and folders are accessed in order in which they were written by the CD writer. Therefore, the playing order may not be the same as the order in which they are expected. For example, a disc with the following folder/file hierarchy is subject to folder select, file select and play back order as illustrated on page 59.

**Note:** Do not attempt to play a media containing a non-MP3/WMA file with the the MP3/WMA extension or a media containing non MP3/WMA files.

**17.2 Stereo Audio Receiver Specifications****Tuner**

FM tuning Range.....	87.5-107.9 MHz
FM Signal-to-Noise.....	80 dB
Stereo Separation.....	45 dB
Capture Ratio .....	2.0 dB
AM tuning Range.....	530.1-710 kHz
Usable Sensitivity (IEC Standard).....	22.5/27.0 ( $\mu\text{v}/\text{dBf}$ )

**General**

Power .....	DC 11.5 -14.4V
Pre Output Voltage .....	5V
Current Consumption .....	< 15A
Stand-By-Mode .....	< 1A
Maximum Mounting Angle .....	30° from horizontal
Fuse.....	15-Amp Mini ATM Type

### 17.3 CD/MP3/WMA folder/file hierarchy

When selected for play, folder search, file search or folder select, files and folders are accessed in the order in which they were written. Because of this, the order in which they are expected to be played may not match the order in which they are actually played. For example, a media with the following folder/file hierarchy is subject to folder search, file search or folder select as shown below. An outline of a media with MP3/WMA is shown below. Subfolders are shown as folders in the folder currently selected.

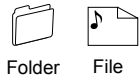
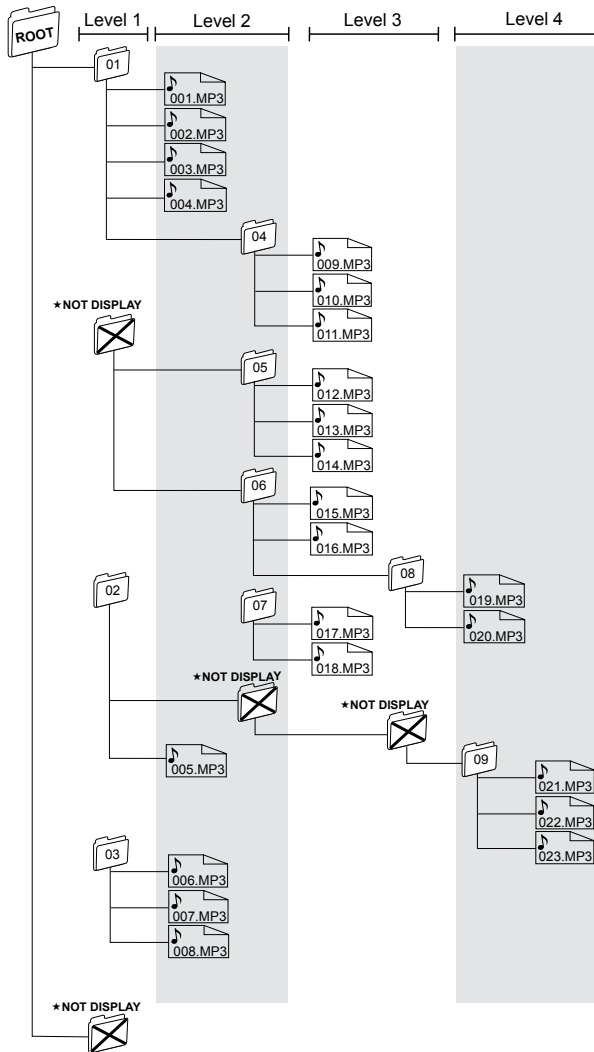

- The equipment assigns folder numbers. The user cannot assign folder numbers.
- ★ It is not possible to check folders that do not include MP3/WMA files. (These folders will be skipped without displaying the folder number and name)

**A. CD/MP3/WMA File/folder play**

1. There are three different play methods as following:
  - Press the M2 button more than 3 seconds during playing an MP3/WMA disc for “intro play” to all files of the current folder. Intro play should restart from the first song of the current folder, after all files in the current files have been intro-played. To disable current folder “intro play”, long press M2 button more than 3 seconds.
  - Press the M2 button less than 3 seconds is “intro play” to all files on the disc. Intro play should re-start at the very first file of the disc after all files in the disc has been intro played. To disable all files “intro play”, press M2 button less than 3 seconds.
2. File/Folder Repeat play :
  - Press the M3 button more than 3 seconds during playing MP3/WMA disc for “repeat play” for all files of the current folder and keep on repeat playing the current folder until “repeat play” is disabled. To disable current folder “repeat play”, long press M3 button more than 3 seconds.
  - Press the M3 button less than 3 seconds to “repeat play” the current file and keep on repeat playing the current file until the “repeat play” is disabled. To disable current file “repeat play”, press M3 button less than 3 seconds.
3. File/Folder Random play:
  - Press the M4 button more than 3 seconds during playing MP3/WMA disc to “random play” for all files of the current folder. To disable current folder “random play”, long press M4 button more than 3 seconds.
  - Press the M4 button less than 3 seconds is “random play” to all files on the disc. To disable all file “ random play”, press M4 button less than 3 seconds.





**B. CD/MP3/WMA File or Folder Search**

1. Folder/Files Navigate Searching
  - Press the BAND button. The LCD will display "Navigate", and the illumination around the select knob will blink. Rotate the knob to navigate through all folders and sub-folders on the disc. The folder names will be displayed on the LCD. Press the select knob for more than three seconds to play the first file in the folder. Press the select knob for less than three seconds to access the sub-folders or files. Rotate the select knob to navigate, then press the select knob to confirm and begin file play. During navigation search, press AS/PS or rotate the select knob counter-clockwise to move back to the last upper level of a folder.



### C. ID3 information display

- For any MP3/WMA file recording with ID3 Tag information. The ID3 information such like Album title, Track title, Artist Title will be displayed and automatic scrolling through the LCD while the file is playing. User also allows pressing the AS/PS button repeatedly to view the ID3 tag information manually.

ICON	DESCRIPTION
	FOLDER ICON
	FILE ICON
	TRACK ICON
	ARTIST ICON
	ALBUM ICON

### 17.4 Stereo Audio Receiver Troubleshooting

Before going through the check list, check wiring connection. If any of the problems persist after check list has been made, consult your nearest service dealer.

Symptom	Cause	Solution
No power	The fuse is blown	Replace the fuse
Disc cannot be loaded or ejected	Presence of CD disc inside the player	Remove the disc in the player, then put a new one
	Inserting the disc in reverse direction	Insert the compact disc with the label facing upward
	Compact disc is extremely dirty or defective disc	Clean the disc or try to play a new one
	Condensation	Leave the player to off for an hour or so, then try again
No sound	Volume is in minimum	Adjust volume to a desired level
	Wiring is not properly connected	Check wiring connection
The operation keys do not work	The built-in microcomputer is not operating properly due to noise	Press the RESET button. Front panel is not properly fixed into its place

Sound skips.	The installation angle is more than 30 degrees	Adjust the installation angle to less than 30 degrees
	The disc is extremely dirt or defective disc	Clean the compact disc. Then try to play a new one
The radio does not work. The radio station automatic selection does not work.	The antenna cable is not connected	Insert the antenna cable firmly
	The signals are too weak	Select a station manually
ERROR	Mechanism Error	Press the eject button to correct the problem. If the error code does not disappear, consult your nearest service dealer
Disc Error	Maybe disc dirty/disc scratched/disc upside down	Replace the disc

**17.5 Standard Wireless Remote Control Functions**



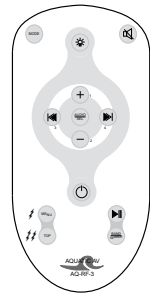



A remote control is supplied on all spas with the optional audio system. This remote provides control over some of the radio and CD playback functions.



**A. External iPod®/MP3 Playback**

The supplied remote control provides no control over external iPod/MP3 player operation of any kind with the exception of volume control and source selection. All external iPod/MP3 playback operations are performed solely by the iPod/MP3 player.

<b>Wireless Remote Control Command Summary</b>			
<b>Button</b>	<b>Operation</b>	<b>Button</b>	<b>Operation</b>
	LED Light Button: Press and hold to activate white LED light. (The light only illuminates, it has no function).		Mute Button: Press once to turn sound off (the word "MUTE" appears on the screen), press again to reactivate sound (the word "MUTE" will disappear from the screen).
	Mode Button: Press continuously to switch between Stereo, CD and Aux modes.		Menu Button: Controls most of the stereo performance functions. See page 51.
	Volume Button: Used to increase volume level, between 0 to 46.		Top Button: No Function

	<p>Volume Button: Used to decrease volume level between 46 to 0.</p>		<p>Power Button: Press once to turn power on to the radio, press again to turn radio off.</p>
	<p>Seek/Track Down Button:</p> <ul style="list-style-type: none"> <li>In CD mode: Press to rewind tracks or press and hold to do a fast rewind.</li> <li>In radio mode: Seeks down for stations.</li> </ul>		<p>Play/Pause Button: Press once to pause track, press again to resume.</p>
	<p>Seek/Track Up Button:</p> <ul style="list-style-type: none"> <li>In CD mode: Press to move forward tracks or press and hold to do a fast forward.</li> <li>In radio mode: Seeks up for stations.</li> </ul>		<p>Band/Search Button:</p> <ul style="list-style-type: none"> <li>In radio mode: Switches bands between FM1, FM2, FM3, AM1, and AM2.</li> </ul>
	<p>Audio/Select Button: Controls most of the stereo sound functions. See page 52.</p>		

**B. Bonding the Remote and Stereo**

If your remote does not operate the stereo, you may need to bond them by pressing on of the following methods:

- Press and hold the MUTE button for 5 seconds or;
- Press the four buttons MODE, MUTE, BAND/SEARCH, and TOP buttons at the corners one by one clockwise. This must be completed within two seconds.

## 17.6 iPod®/MP3 Player Connection

### A. Connecting Your iPod/MP3 Player

1. Plug in the iPod/MP3 Player (purchased separately) with supplied mini RCA cable into the auxiliary port (A).
2. Plug the other end of the supplied cable into the phone jack connection on the iPod/MP3 Player.
3. After connecting the device, you can place it in the housing provided above the stereo (B).

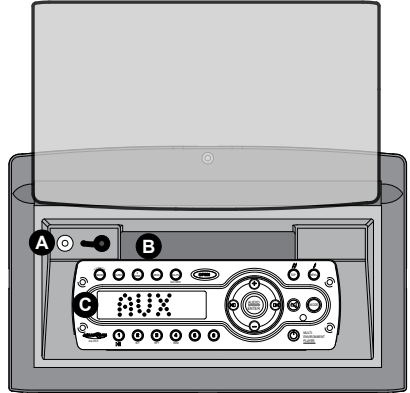

### B. Enabling iPod/MP3 Player for use

1. Select preferred song/album/play list and start playback prior to plugging in iPod/MP3 Player.
2. Press the "Mode" button on stereo receiver or the mode button on the remote until the display reads "AUX" (C).

### C. Operating iPod/MP3 Player

All playback operations are conducted via the iPod/MP3 Player. The Stereo Deck and/or Stereo Remote functions do not work on the external iPod/MP3 Player (except volume control).



### **CAUTION: RISK OF ELECTRICAL SHOCK OR EQUIPMENT DAMAGE!**

Never install, remove or operate iPod/MP3 Player while hands are wet or while sitting partially or fully immersed in spa!

## 17.7 Wireless Remote Battery Replacement Procedure

1. Turn the remote unit over and locate the battery door (Figure A).

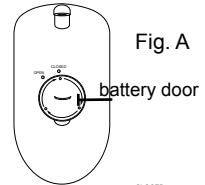

Fig. A

2. Rotate the battery door, with a coin, counterclockwise until the dot aligns with the Open arrow (Figure B).

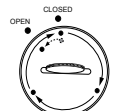

Fig. B

3. Remove battery door using coin to pry the door upward (Figure C).



Fig. C

4. Replace battery using CR2025 or equivalent (Figure D).

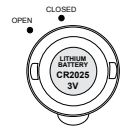

Fig. D

5. Reinstall the battery cover, using the coin to close (Figure E).

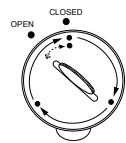

Fig. E

**Note:** Remote unit is water resistant not waterproof, therefore the unit should be stored in a dry location within your home and never be left in the spa while the cover is on and spa is not in use.









## Free Manuals Download Website

<http://myh66.com>

<http://usermanuals.us>

<http://www.somanuals.com>

<http://www.4manuals.cc>

<http://www.manual-lib.com>

<http://www.404manual.com>

<http://www.luxmanual.com>

<http://aubethermostatmanual.com>

Golf course search by state

<http://golfingnear.com>

Email search by domain

<http://emailbydomain.com>

Auto manuals search

<http://auto.somanuals.com>

TV manuals search

<http://tv.somanuals.com>