

# Sungale



AA850

## *Digital Photo Frame User's Manual*



For ongoing product improvement, this manual is subject to modification without prior notice.

Download from [Www.Somanuals.com](http://Www.Somanuals.com). All Manuals Search And Download.

# Contents

## User Notice

As this product has met electronic emission standards in registration for use at home, it can be safely used in all areas, including residential.



## Chapter 1 Introduction

Product Introduction	3
Safely Precautions	4
Components	6
Player Overview	7

## Chapter 2 Connection

Connection	12
Memory Card Extraction	15
PC Connecting	16

## Chapter 3 Usage

Photo	18
Music	20
Back Music	22
Movie	23
Additional Functions	25

## Chapter 4 Editing & Settings

Editing	28
Settings	31
ASSP Store Technology	35

## Chapter 5 Customer Management

Question&Answer	37
Troubleshooting	39
Product Specifications	40
FCC and Safety Information	41



## Chapter 1

# Introduction

---

<b>Product introduction</b>	<b>3</b>
<b>Safety Precautions</b>	<b>4</b>
Power Related	4
Product Related	5
<b>Components</b>	<b>6</b>
Basic components	6
<b>Player overview</b>	<b>7</b>
Electronic Frame	7
Remote Control	9

# Digital Photo Frame

## Product introduction

---

The Digital Photo Frame is a convenient image album that keeps your favorite images at your fingertips.

With its bright and vivid LCD screen, this Digital Photo Frame offers an alternative to photo printing, adding a new level of convenience to your life.

With its diverse file management functions, this Digital Photo Frame allows you to relive your cherished memories anytime.

# Digital Photo Frame

## Safety Precautions

Make sure to review the precautions to ensure user safety.

### Power Related

**⚠ WARNING:** indicates information that, if neglected, could result in serious injury and/or death to the user.

**⚠ CAUTION:** indicates information that, if neglected, could result injury to the user and/or material damage.

01. Use only the authorized power supply product. Failure to do so could result in product malfunction.



02. When connecting the power source, make sure that your hands are free of moisture. Failure to do so could result in electrical shock.

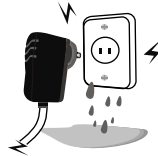

03. Make sure that the power supply is firmly plugged in and not loose. Failure to do so could result in electrical shock.

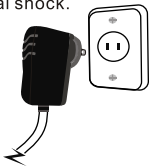

04. Do not let the power cord get overly entangled and do not place any heavy objects on the cord. Failure to do so could result in electrical shock.

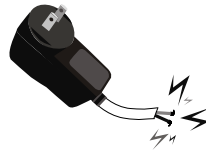

05. Do not connect the power supply to an electrical power strip with other various connections. Failure to do so could result in fire.

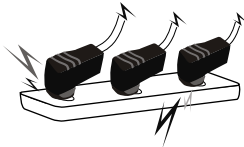

06. Disconnect the power supply during inclement weather conditions that include thunder and lightning. Failure to do so could result in fire.

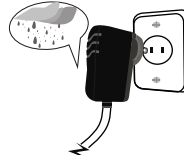

# Digital Photo Frame

## Safety Precautions

Make sure to review the precautions to ensure user safety.

### Product Related

01. Dropping the product or subjecting it to a significant impact can cause critical damage.

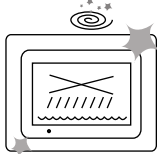

02. Spilling water or any other liquid on the product can cause critical damage.



03. Striking or scratching the LCD screen can cause critical damage.

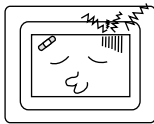

04. When cleaning the LCD screen, avoid damage by turning off the power and then wiping gently with a soft cloth.

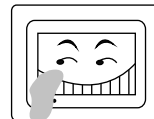

05. Subjecting the product to severe humidity and /or heat can cause damage.

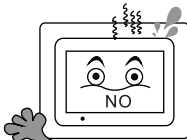

06. Make sure to turn the power off before connecting or disconnecting the power supply.

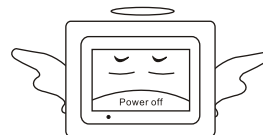

# Digital Photo Frame

## Components

---

For the improvement of product performance and/or quality, the basic components may be modified without prior notice. The components may differ slightly in appearance with the provided images.

### Basic Components

The components are provided upon product purchase.



Digital Photo Frame



Remote Control



Power Adapter



USB Cable



User Manual



Quick-Start Guide

# Digital Photo Frame

## Player Overview

The components may differ slightly in appearance with the provided images.

### Electronic Frame

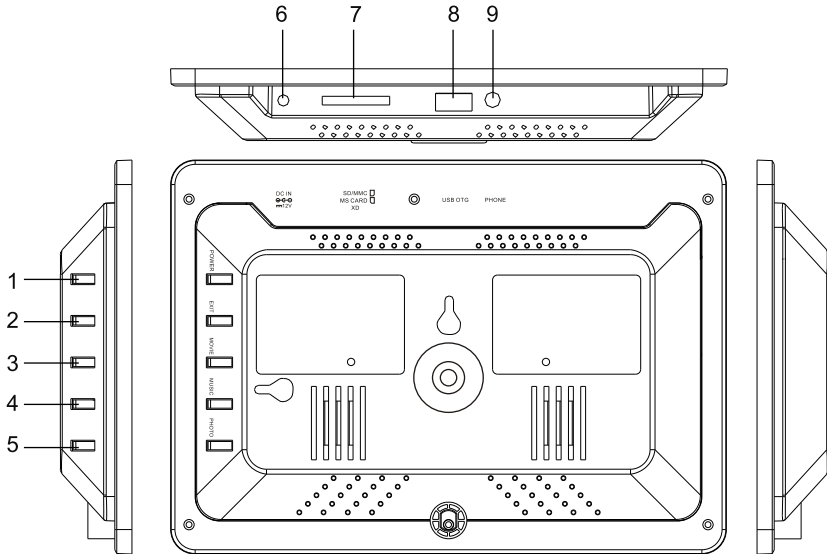

1. **POWER** : Switch the player between “on” and “off” modes .
2. **EXIT**: Press to stop the current action and return to the upper menu.
3. **MOVIE**: Press to start watching movies.
4. **MUSIC**: Press to start playing songs .
5. **PHOTO**: Press to start slide show of pictures .
6. **DC IN** : Insert the DC power adaptor to the DPF player.
7. **SD/MMC/MS/XD** : Insert the SD/MMC/MS/XD card .
8. **USB OTG** : Connect the USB removable storage device/mobile hard disk to the DPF.
9. **PHONE**: Insert for earphone use.



# Digital Photo Frame

## Player Overview

---

The components may differ slightly in appearance with the provided images.

### Rear side

10. Speaker: Stereo speakers built-in

11. Wall Mountable

12. Stand: Using the stand provided you can stand the body with horizontal view and vertical view .

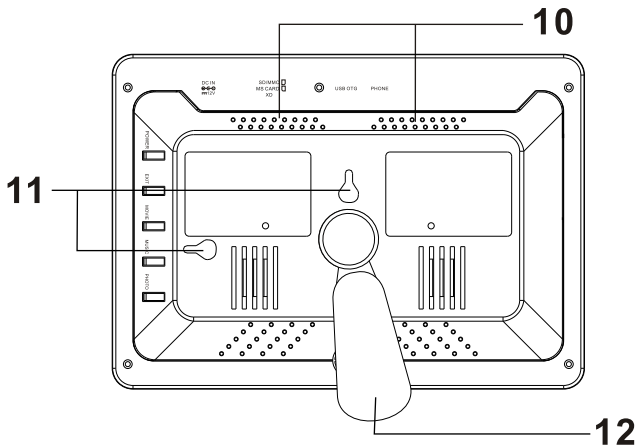

### Rear side

# Digital Photo Frame

## Player Overview

The components may differ slightly in appearance with the provided images.

### Remote Control



#### Power:

Press **POWER** to turn the player on and off.

#### 16:9/4:3

Press this button to switch the ratio picture between original and optimal.

#### Music:

press **MUSIC** to play songs.

#### Slide Show:

Press **SLIDE SHOW** to continually cycle through all of the pictures in the device.

#### Step Show:

Press **STEP SHOW** to display a single picture; each press will advance one picture at a time.

**Note:** Remove Red Tab to activate battery.

# Digital Photo Frame

## Player Overview

---

### Navigation Buttons:

Press the arrow keys to move the cursor to the desired icon.

### Enter:

press **ENTER** to enter/confirm.

### EXIT:

Press **EXIT** to stop the current action and return to previous menu.

### ROTATE:

Press **ROTATE** to rotate the picture. These operations are allowed only when a picture is being displayed normally and will be cancelled automatically.

### ZOOM:

Press **ZOOM** repeatedly to zoom out /in the picture.

### OSD:

Press **O SD** to display the state of the playing file.

### VIEW:

Press **VIEW** to view 9 pictures at a time in thumbnail size. Use the up /down/left/right buttons to select the picture and press enter to confirm .

### MENU:

Press **MENU** to return to main menu.

### VOL+/-:

Press the **VOLUME** button to adjust the player's volume.



## Chapter 2

# Connection

---

Power Connection	12
Connect to USB Port	13
Memory Card Insertion	14
Memory Card Extraction	15
PC Connecting	16

# Digital Photo Frame

## Connection

---

### Power Connection

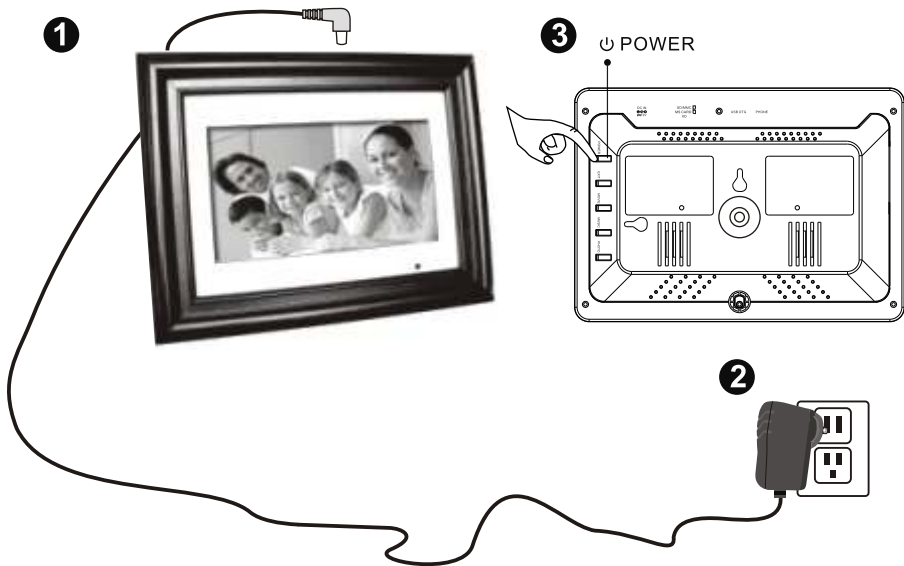

1. Connect the power adapter to the DC 12V on the product.
2. Plug in the power cable.
3. Press POWER to turn the player on .

# Digital Photo Frame

## Connection

---

### Connect to USB Port

USB HOST: Insert various USB removable storage device as an extra source.

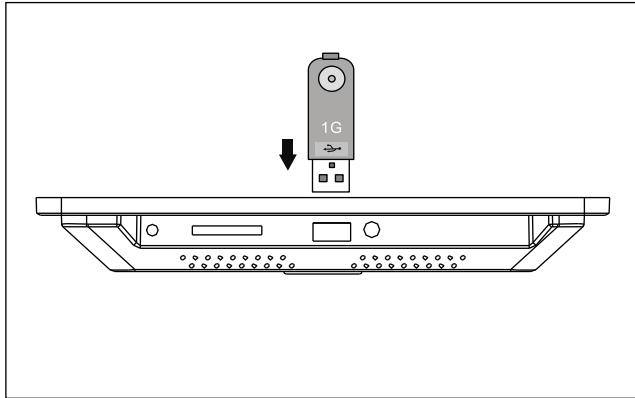

# Digital Photo Frame

## Connection

---

### Memory Card insertion

When inserting a memory card into the product, refer to the image to make sure that both the memory card and product are aligned correctly. (The side of the memory card on which the sticker is affixed should face to the front)

Aligning the memory card upside down or to the reverse side may cause damage that is the sole responsibility of the user. (Use of SD, Memory Stick, MMC cards, XD card enabled)

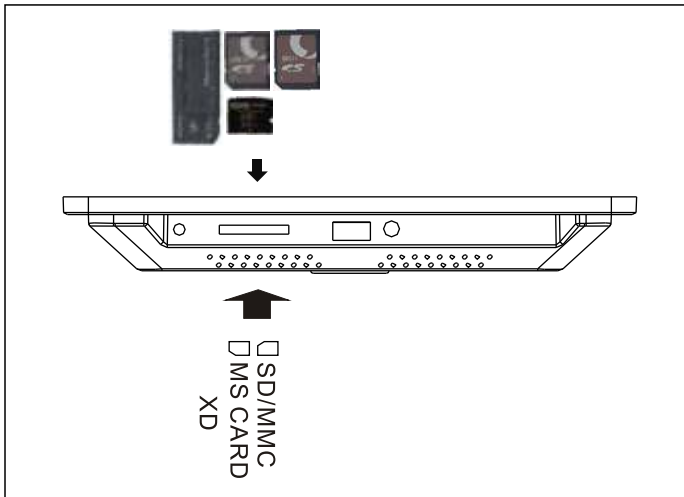

**Note:** MS Duo isn't compatible alone. But it can be supported with the help of MS Duo adapter.

# Digital Photo Frame

## Connection

---

### Memory Card Extraction

Grip the card firmly between two fingers , and pull the card straight out without bending it. Refer to the image below:

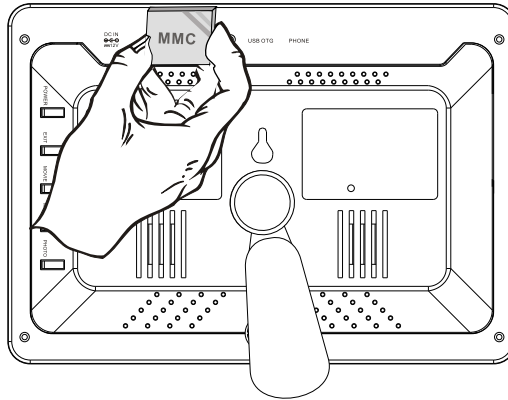

With no memory card present, the product will display images stored in the Frame's internal memory.



# Digital Photo Frame

## PC Connecting

### Connecting your DPF to your PC

Use the supplied USB cable to connect the DPF to your PC.

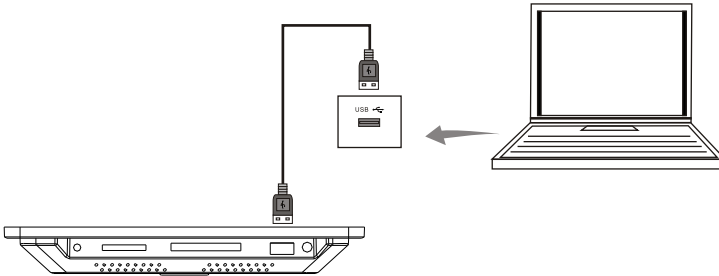

1. After connecting with the PC, the PC's screen will display as the below diagram.
2. Press "OK", then the Pc's screen will display the contents of memory. Then you can copy your required documents from your PC to your Multimedia DPF.
3. After copying the documents, close the window of the " Safely Remove Hardware" on your PC, then pull out the USB cable.
4. Then the Multimedia DPF will run normally.

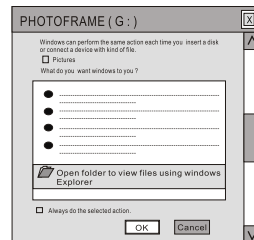

- Note:**
1. When connected to the computer ,the remote keys are inactive.
  2. While transferring documents to the DPF's Internal Memory, you have to restart the DPF to display the document you have transferred.
  3. If you want to format the diskettes, you' d better set the File System to be " FAT" or " FAT32" . Don' t set the File System to be "NTFS" , otherwise , you will fail to format the diskettes.



**Chapter 3**

**Usage**

---

<b>Photo</b>	<b>18</b>
<b>Music</b>	<b>20</b>
<b>Back Music</b>	<b>22</b>
<b>Movie</b>	<b>23</b>
<b>Additional Functions</b>	<b>25</b>

# Digital Photo Frame

## Photo

### Accessing Your Photo Directory

**Note:** Press MENU to return to the main menu.

Select the desired device and press ENTER to enter into the device menu.



### Locating the photo browse screen

Use the directional keys to select between Photo icon in the device menu, press ENTER to enter the photo browse screen.



### Viewing a photo in Full Screen

In the photo browse screen, press ENTER to create a slide show of the images in full screen.



# Digital Photo Frame

## Photo

---

### Rotating a Photo

After selecting the desired photo, use the ROTATE button to rotate (clockwise) the photo to the desired position.



# Digital Photo Frame

## Music

### Music

#### Listening to Music

#### Locating the Device Directory

From the main menu, select the desired device and press ENTER to enter the device menu.

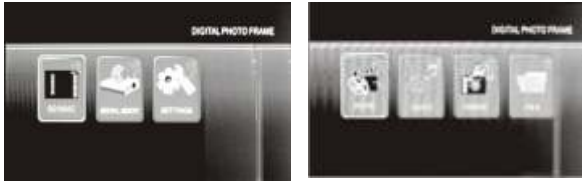

#### Locating to the Music Directory

Use the directional keys to select MUSIC in the device menu and press ENTER.



#### Selecting a Music File

Use the directional keys to select the desired music file, press ENTER to play.



# Digital Photo Frame

## Music

---

### Adjusting the volume

During playback, press the Vol+ or Vol- buttons to adjust the volume .

**NOTE:** Only Mp3 format files can be played.



# Digital Photo Frame

## Back Music

**Note:** To utilize this feature you must have picture files (JPG) and music files (MP3) saved to the same file source (ie. Memory Card, USB Device or Internal Memory).

1. From the main menu, select the desired device and press ENTER.

2. Use the directional keys to select PHOTO, press ENTER to enter the photo browse screen.

3. Select a photo in the photo browse screen, press ENTER to view the photos in slide show mode, press MUSIC button to start a musical slide show, press ◀ or ▶ to change the music.



# Digital Photo Frame

## Movie

A variety of movie formats , including those taken with a digital camera, can be played on your frame.

### Activate the Device Selection Screen

From the main menu, select the desired device and press ENTER to enter into the device menu.



### Locating the Movie Directory

Use the directional keys to select MOVIE in the device menu and press ENTER to enter the movie list.



### Selecting and Playing a movie

Press ▲ or ▼ to select the desired movie, press ENTER to play the movie. Press ◀ or ▶ to play the previous or the next movie.





# Digital Photo Frame

## Movie

---

### Adjusting the Volume

During playback ,use the VOL(+) or VOL (-) buttons to adjust the volume.

**NOTE:** This frame supports the following video file types for direct playback:  
1.MPEG-1,MPEG-4 (AVI) format files can be played.  
2.Videos recorded on most digital cameras.



# Digital Photo Frame

## Additional Functions

### Zoom

During photo playback, press ZOOM button to magnify the image as follows:

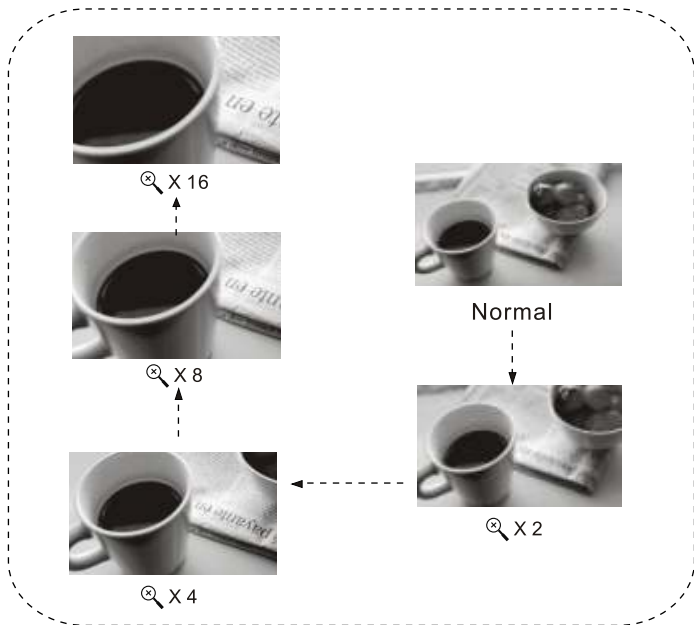
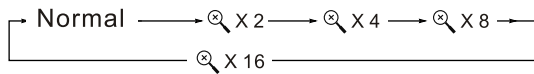

### Moving the photo

After zooming the photo, you can press the directional keys to move the photo up/down/left/right optionally.

# Digital Photo Frame

## Additional Functions

---

### Slide Show

In any state press SLIDE SHOW to create a slide show of the images on your internal memory.

### Step Show

Press the STEP SHOW button during a slide show. The slide show will pause, displaying the image currently on the screen. Each press will advance your slide show one picture.





**Chapter 4**

# Editing & Settings

---

<b>Editing</b>	<b>28</b>
Copy file	28
Delete file	30
<b>Settings</b>	<b>31</b>
<b>ASSP Store Technology</b>	<b>35</b>

# Digital Photo Frame

## Editing Files

### Editing Files

#### A. Copy file

From the main menu, select the desired device , press ENTER to enter the device menu . Select File and press ENTER to enter the file list .



In the file list , press ▲ or ▼ to select the file you want to copy , press ► to confirm .



Then press the OSD button , select COPY and press ENTER to display the card information , press ► to confirm .



# Digital Photo Frame

## Edit Files

---

Press ENTER to start transferring the selected file .

After the file is transferred successfully, the screen shall display as follows:



# Digital Photo Frame

## Edit Files

### B.Delete File

Form the main menu, select the desired device, press ENTER to enter the device menu. Select File and press ENTER to enter the file list.

In the file list, press ▲ or ▼ to select the file you want to delete, press ► to confirm.



Then press OSD button, select DELETE and press ENTER to confirm.



Press ENTER to start deleting the selected file.



# Digital Photo Frame

## Settings

---

### Settings

Select SETTINGS in the main menu and press ENTER to enter the setup menu .



Use ▲ or ▼ to select the menu item you want to set .

### Language

Then press ◀ or ▶ to select Language in the setup menu, the only display language is English.





# Digital Photo Frame

## Settings

### Slide Show Time

Press ▲ or ▼ to select Slide Show Time in the setup menu, then press ◀ or ▶ to change your selection (3s/5s/15s/1mins/15mins/1hour)



### Transition Effect

Press ▲ or ▼ to select Transition Effect in the setup menu, then press ◀ or ▶ to change your selection (off/Random/ Sequential/ Bottom\_To\_Top/Top\_To\_Bottom/Left\_To\_Right/Right\_To\_Left/Door\_Close/Door\_Open/Hori\_Cross/Verti\_Cross/Fading/Vexpand\_Top/ Vexpand\_Bottom/ Vexpand\_Middle /Hexpand\_Left/Hexpand\_Right/Hexpand\_Middle/Fc\_Ken\_Burn)



### Music Repeat mode

Press ▲ or ▼ to select Music Repeat Mode in the setup menu, then press ◀ or ▶ to change your selection (Repeat one /Repeat all/Repeat off)



# Digital Photo Frame

## Settings

---

### Music Repeat mode

Press ▲ or ▼ to select Music Repeat Mode in the setup menu, then press ◀ or ▶ to change your selection (Repeat one/Repeat all/Repeat off)



### Movie Repeat mode

Press ▲ or ▼ to select Movie Repeat Mode in the setup menu, then press ◀ or ▶ to change your selection (Repeat one/Repeat all/Repeat off)



# Digital Photo Frame

## Settings

---

### Default

Press ▲ or ▼ to select DEFAULT in the setup menu , press ENTER to restore to the factory default settings as follows :

A: Language is English .

B: Slideshow Time is 5s, Transition Effect is Random .

C: Music Repeat Mode and Move Repeat Model are Repeat all .

D: Display Mode is Stretch



# Digital Photo Frame

## Auto Screen-suiting Photo Store Technology

When a PC transfers photos to the DPF with using USB connection, this function can auto-compress the photos' sizes to suit the screen's resolution, the display effect on the screen is same as the original big photo files. After the processing, the storage quantity of the photos will have a tremendous increment .

Operations Steps :

- 1.Connect your DPF to your PC, four removable disk will appear under the “My Computer” icon on the computer desktop.
- 2.From your PC, click “My Computer” to access it , select and click the disk named “memory ” and access it .
- 3.Drag the images desired to the disk named “ memory”

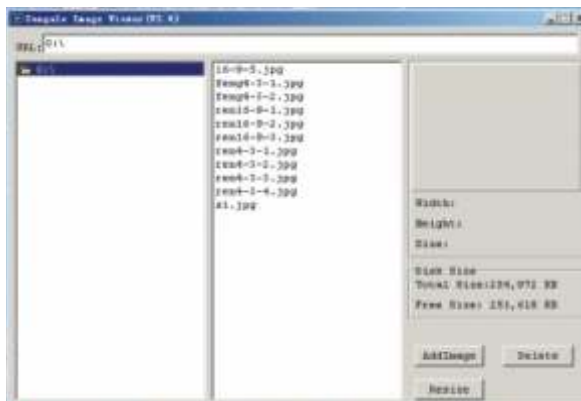

- 4.Find the tool file named “ Image Viewer.exe” and access it .
  - 5.Click “ Resize” to transform the photo’s Width and Height to the default width and height .
  - 6.You can also click “Add Image” and add the photos desired , it will automatically transform the photos to the default Width and Height .
  - 7.If you want to delete the images : Firstly ,select the photo, then click “ Delete”.
- Note : Please keep a copy of the file “ Image View .exe ” in your computer , in case the file is deleted from your DPF’s memory.



**Chapter 5**

**Customer Management**

---

Question & Answer	37
Troubleshooting	39
Product Specifications	40
FCC and Safety Information	41

# Digital Photo Frame

## Question & Answer

---

### Q&A

This chapter will attempt to troubleshoot common problems that one may experience with the Multimedia DPF. If this guide can not solve your problem. Do not dismantle the machine yourself.

Question	Answer
What photo, music, and video formats are supported by the Multimedia Digital Photo Frame?	Photo: JPG Music: MP3 Video: MPEG-I, MPEG-4(avi and divx format)
What memory cards are compatible with the digital frame?	Secure Digital Card (SD)/MultiMedia Card (MMC) Memory Stick, XD, Memory stick Pro.
How do I store music files?	Use a personal computer and a popular audio editing software such as Music Match to convert your music to MP3 format. Transfer the MP3 file to the memory card by using a Memory Card Reader. Transfer the Mp3 files from pc or USB directly.
Does Multimedia Digital Photo Frame have built-in memory?	Yes. The player has an internal memory to store media file. Its memory volume is 128MB Do not rename the memory's name.
Can I insert multiple memory cards?	Yes, you can insert one of SD, MMC, MS, XD card each time.
Does it play every type of AVI video file?	No. The device only works with the AVI files taken by most digital cameras.
What is the best picture resolution displayed on the screen?	The player's best resolution is 480(RGB) x 234.
Can I rotate a picture on the screen?	Yes. Use the ROTATE buttons on the remote control to rotate a picture. Note: The rotated picture will return to its original orientation after you power off the digital frame.
Why Digital picture Frame does not advance to next picture?	1. There is only one picture in the frame. 2. You are viewing high-resolution pictures on the card, High-resolution pictures can take some to display. 3. You are in still display mode. 4. The next picture is damaged.

# Digital Photo Frame

## Question & Answer

---

Can I adjust the colors of the picture?	You can adjust the picture display in the video settings in the set up menu. You can also adjust the brightness and contrast, however, this will not alter the contents of your pictures files.
Why can't my PC find the internal memory?	Turn on the multimedia digital photo frame and wait for the function menu to appear, then connect the USB cable from the unit to PC, If the found new device prompt does not appear on your computer screen, look in "my computer" for a USB mass storage device.
Why the unit can't play pictures?	1.Ensure the pictures are stored in the card or USB. 2.The unit only recognizes pictures stored in JPEG, JPG format. 3. If can not play the pictures, please format your card / internal memory
What MPEG-4 formats are supported by the multimedia digital photo frame?	The player can support AVI and DIVX video file.
Why won't my multimedia digital photo frame play my downloaded music?	The player can only play mp3
Why doesn't the photo cover the entire screen?	The resolution required for a picture to cover the entire screen must be greater than 480 x 234 pixels.
Can the DPF player connect with all computers?	No.the USB port of the PC connected with the player must be USB 2.0, and the PC must be windows system (eg.windows 2000, windowsXP.etc).

# Digital Photo Frame

## Troubleshooting

---

If you have any questions, please consult the troubleshooting guide below. Some simple checks or a minor adjustment on your part may eliminate the problem.

### No power

- Ensure the power button is on
- Ensure the power cord is not damaged
- Ensure the power plug is connected firmly to the outlet

### Could not read the card

1. Please copy the content in your card to your PC, then format your card, then pass your photos/music/movies in your card again, then insert the card to DPF .
2. Ensure the card is not damaged
3. Ensure the card is connected to the DPF correctly
4. Ensure the card has content(photo/ music/movie), if no content in card, the screen will display "Files can't be found"

### Remote control not working

1. Ensure the batteries are inserted
2. Ensure the batteries "protective plastic" is pulled out.



# Digital Photo Frame

## Product Specifications

Specifications can be changed without prior notice in the interest of improving product performance.

### Product Specifications

Item		Details
<b>LCD Display</b>	<b>Size</b>	<b>8.5 Inch (Analogue)</b>
	<b>Resolution</b>	<b>480(Horizontal)*234(Vertical)</b>
<b>Memory</b>	<b>Internal Memory</b>	128MB
	<b>Compatible Memory Cards</b>	SD / MMC / Memory Stick / XD
<b>Remote Control</b>		<b>18 Keys</b>
<b>Support Media Formats</b>	<b>Images</b>	JPG
	<b>Video</b>	AVI, MPEG-1(mpg/dat), MPEG-4,
	<b>Audio</b>	Mp3
<b>Internal Speaker</b>	<b>Stereo</b>	<b>2W+2W</b>
<b>Power</b>	<b>Adapter</b>	Input: 100~240V AC, Output: 12V, 1.4A DC
	<b>Electricity Consumption</b>	10 W (Operating)
<b>Size</b>	<b>Width*Height*Depth</b>	<b>282 (w)*216(h)* 48 (d)[mm]</b>
<b>Weight</b>	<b>Kg</b>	1.8
<b>USB Connection</b>		<b>USB OTG</b>

# Digital Photo Frame

## FCC and Safety Information

---

### • FCC Part 15.19

This device complies with Part 15 of the FCC Rules .Operation is subject to the following two conditions: (1) this device may not cause harmful interference , and (2) this device must accept any interference received ,including interference that may cause undesired operation .

### • FCC part 15.21

Warning: Changes or modifications to this unit not expressly approved by the party responsible for compliance could void the user' s authority to operate the equipment.

### • FCC part 15.105

Note : This equipment has been tested and found to comply with the limits for a Class B digital device ,pursuant to Part 15 of the FCC Rules, These limits are designed to provide reasonable protection against harmful interference in a residential installation .This equipment generates, uses, and can radiate radio frequency energy and ,if not installed and used in accordance with the instructions, may cause harmful interference will not occur in a particular installation . If this equipment does cause harmful interference to ause harmful interference to radio or television reception ,which can be determined by turning the equipment off and on ,the user is encouraged to correct the interference by one or more of the following measures:

- Reorient or relocate the receiving antenna.
- Increase the separation between the equipment and receiver.
- Connect the equipment into an outlet on circuit different from that to which the receive is connected.
- Consult the dealer or an experienced radio TV technician for help.

# LIMITED WARRANTY

The limited warranty set forth below is given by Sungale Group Inc. ("SGI") with respect to Sungale brand DPF players and other consumer electronics products purchased and used in the United States of America. SGI warrants this product against defects in material or workmanship as follows:

**LABOR:** For a period of ninety (90) days from the date of purchase, if this Product is defective, SGI will repair or replace the Product, at its option, at no charge. After this ninety (90) days period up to one year, a labor charge of US\$30.00 will be charged for each service.

**PARTS:** For a period of one year from the date of purchase, SGI will supply, at no charge, new or rebuilt replacement parts in exchange for defective parts. After this one year period, SGI will charge the new or replacement parts.

This warranty does not cover: (1) customer instruction, installation or set up; (2) cosmetic damage or damage due to accident, misuse, abuse, or negligence; (3) commercial use of the Product; (4) modification of any part of the Product; (5) damage due to improper operation, improper maintenance, or connection to an improper voltage supply; (6) damage due to an attempted repair of the Product by anyone other than a facility authorized by SGI to service the Product; (7) consumables (such as fuses and batteries). This warranty is valid only in the United States.

The product must be accompanied by a copy of the original retail purchase receipt. If no proof of purchase is attached, the warranty will not be honored and repair cost will be charged.

This warranty is valid with attach written documentation detailing the complaint to the outside or inside of the carton.

This warranty is invalid if the factory applied serial number has been altered or removed from the Product.

SGI reserves the right to modify any design of this product without prior notice.

To obtain warranty service, you must deliver the product freight prepaid, in either its original packaging or packaging affording an equal degree of protection, plus proof of purchase, to:

Service Center  
13358 Monte Vista Avenue,  
Chino, CA 91710  
Tel: **800-473-5156**

REPAIR OR REPLACEMENT AS PROVIDED UNDER THIS WARRANTY IS THE EXCLUSIVE REMEDY OF THE CONSUMER. SGI SHALL NOT BE LIABLE FOR ANY INCIDENTAL OR CONSEQUENTIAL DAMAGES FOR BREACH OF ANY EXPRESS OR IMPLIED WARRANTY ON THIS PRODUCT. EXCEPT TO THE EXTENT PROHIBITED BY APPLICABLE LAW, ANY IMPLIED WARRANTY OF MERCHANTABILITY OR FITNESS FOR A PARTICULAR PURPOSE ON THIS PRODUCT IS LIMITED IN DURATION TO THE DURATION OF THIS WARRANTY.

Some states do not allow the exclusion or limitation of incidental or consequential damages, or allow limitations on how long an implied warranty lasts, so the above limitations or exclusions may not apply to you. This warranty gives you specific legal rights, and you may have other rights which vary from state to state.

Digital Photo Frame

**Sungale**

## Free Manuals Download Website

<http://myh66.com>

<http://usermanuals.us>

<http://www.somanuals.com>

<http://www.4manuals.cc>

<http://www.manual-lib.com>

<http://www.404manual.com>

<http://www.luxmanual.com>

<http://aubethermostatmanual.com>

Golf course search by state

<http://golfingnear.com>

Email search by domain

<http://emailbydomain.com>

Auto manuals search

<http://auto.somanuals.com>

TV manuals search

<http://tv.somanuals.com>