

15.4

*Digital Photo Frame
User's Manual*

AW15B-WF

Sungate

Contents

User Notice

As this product has met electronic emission standards in registration for use at home, it can be safely used in all areas, including residential.



Chapter 1 Introduction

Product Introduction	3
Safely Precautions	4
Components	6
Part Names	7

Chapter 2 Connection

Connection	12
Memory Card Extraction	15
PC Connecting	16

Chapter 3 Usage

Photo	18
Music	20
Back Music	23
Movie	24
Additional Functions	27

Chapter 4 Editing & Settings

Editing	30
Settings	33

Chapter 5 Customer Management

Question&Answer	44
Troubleshooting	46
Product Specifications	47
FCC and Safety Information	48



Chapter 1

Introduction

Product Introduction	3
Safety Precautions	4
Power Related	4
Product Related	5
Components	6
Basic components	6
Player overview	7
Electronic Frame	7
Remote Control	9

Digital Photo Frame

Product introduction

WIFI Digital Photo Frame is a convenient image album that keeps fun and cherished memories at your fingertips.

With its bright and vivid LCD screen, the **WIFI** Digital Photo Frame eliminates the need for tedious photo printing and injects a new level of convenience into your life.

With its diverse storage functions, the **WIFI** Digital Photo Frame allows you to relive wonderful memories anytime.

You can use the **WIFI** Digital Photo Frame to enjoy memories present them with refined images and music.

The pictures can be viewed on **WIFI** Digital Photo Frame over your wireless network, they are accessed from your computer via Windows Media Connect, or over the internet from Google and Yahoo gallery.

Digital Photo Frame

Safety Precautions

Make sure to review the precautions to ensure user safety.

Power Related

⚠ WARNING: indicates information that, if neglected, could result in serious injury and/or death to the user.

⚠ CAUTION: indicates information that, if neglected, could result injury to the user and/or material damage.

01. Use only the authorized power supply product. Failure to do so could result in product malfunction.



02. When connecting the power source, make sure that your hands are free of moisture. Failure to do so could result in electrical shock.

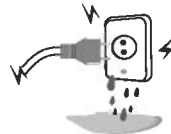

03. Make sure that the power supply is firmly plugged in and not loose. Failure to do so could result in electrical shock.

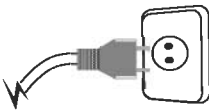

04. Do not let the power cord get overly entangled and do not place any heavy objects on the cord. Failure to do so could result in electrical shock.



05. Do not connect the power supply to an electrical power strip with other various connections. Failure to do so could result in fire.

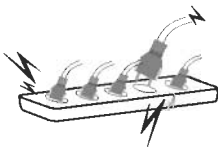

06. Disconnect the power supply during inclement weather conditions that include thunder and lightning. Failure to do so could result in fire.

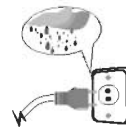

Digital Photo Frame

Safety Precautions

Make sure to review the precautions to ensure user safety.

Product Related

01. Dropping the product or subjecting it to a significant impact can cause critical damage.

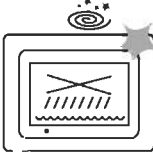

02. Spilling water or any other liquid on the product can cause critical damage.

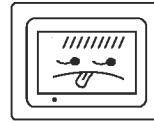

03. Striking or scratching the LCD screen can cause critical damage.

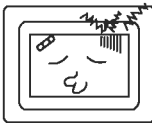

04. When cleaning the LCD screen, avoid damage by turning off the power and then wiping gently with a soft cloth.



05. Subjecting the product to severe humidity and/or heat can cause damage.

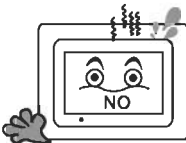

06. Make sure to turn the power off before connecting or disconnecting the power supply.

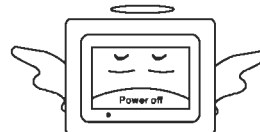

Digital Photo Frame

Components

For the improvement of product performance and/or quality, the basic components may be modified without prior notice. The components may differ slightly in appearance with the provided images.

Basic Components

The components are provided upon product purchase.

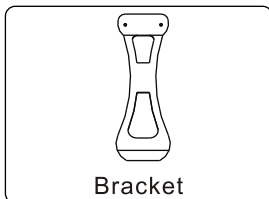
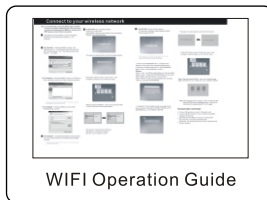
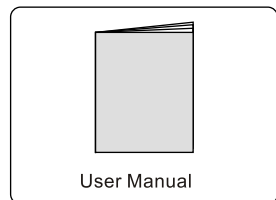
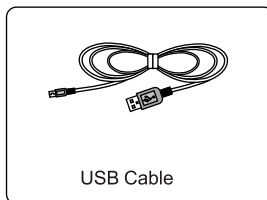
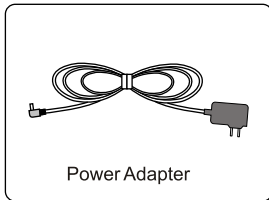
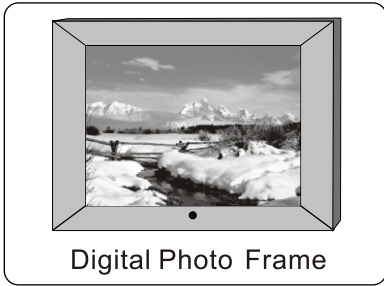

Digital Photo Frame

Player Overview

The components may differ slightly in appearance with the provided images.

Electronic Frame

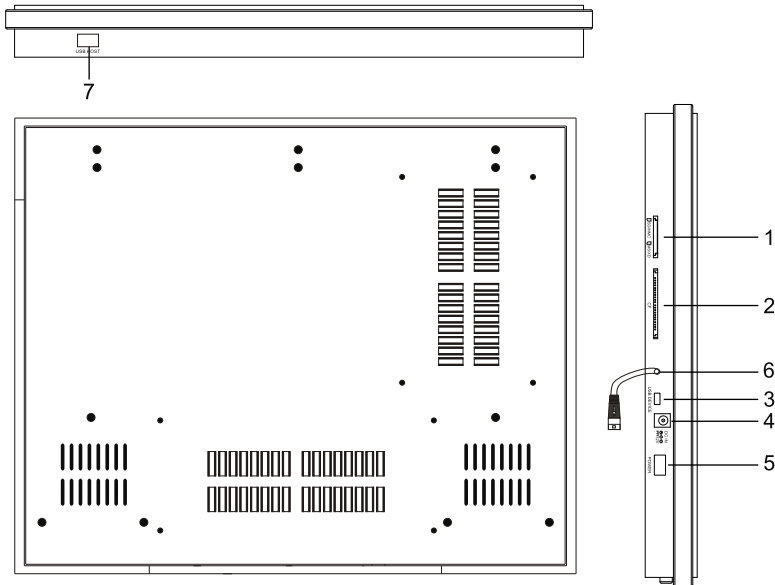

1. MS/SD/MMS/MS Pro/XD Card: Insert MS/SD/MMC/MS Pro/XD card.
2. CF CARD: Insert CF card.
3. USB DEVICE: Connect the USB cable from the DPF player to PC.
4. DC IN: Insert the DC power adaptor to the DPF player.
5. POWER: Switch the player between "on" and "off" modes.
6. USB HOST CABLE: A cable to connect to the USB DEVICE to make the USB HOST effective.
7. USB HOST: Connect the WIFI Dongle or the USB removable storage device to the DPF.

Note: Before doing this, be sure to connect the attached USB HOST CABLE to the USB DEVICE first.

Digital Photo Frame

Player Overview

The components may differ slightly in appearance with the provided images.

Rear side

- 12. Wall Mountable
- 13. Speaker: Stereo speakers built-in

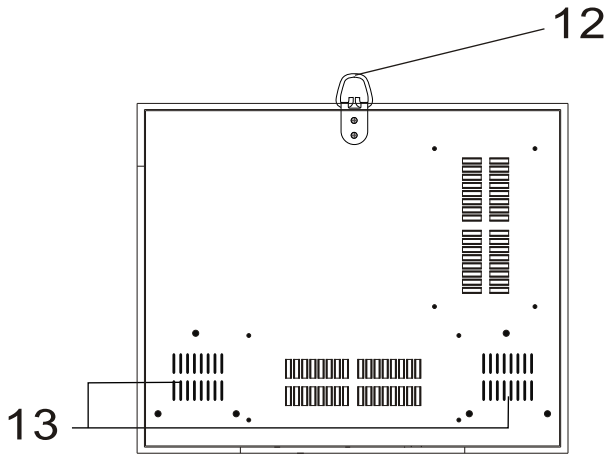

Rear side

Digital Photo Frame

Player Overview

The components may differ slightly in appearance with the provided images.

Remote Control



POWER:

Press **POWER** to turn the player on and off.

MUTE:

press **MUTE** to toggle sound on and off.

PHOTO:

Press **PHOTO** to start slide show of picture. When playing media files through PC or Yahoo/Google, the shortcut button is invalid.

MUSIC:

press **MUSIC** to play songs. When playing media files through PC or Yahoo/Google, the shortcut button is invalid.

MOVIE:

Press **MOVIE** to play movies. When playing media files through PC or Yahoo/Google, the shortcut button is invalid.

CALENDAR:

Press **CALENDAR** button to enter into calendar screen. When playing media files through PC or Yahoo/Google, the shortcut button is invalid.

SETUP:

Press **SETUP** to setup the LANGUAGE / SLIDE SHOW DURATION / SLIDE SHOW MODE / NETWORK / CALENDAR and so on. When playing media files through PC or Yahoo/Google, the shortcut button is invalid.

Note: Remove Red Tab to activate battery.

Digital Photo Frame

Player Overview

ROTATE:

Press **ROTATE** to rotate the picture. These operations are allowed only when a picture is being displayed normally and will be cancelled automatically.

ZOOM:

Press **ZOOM** repeatedly to zoom out/in the pictures.

VIEW:

Press **VIEW** and there are nine pictures in the nine picture preview page.

Scroll up/down/left/right buttons to select the picture and press enter to confirm.

When playing media files through PC or Yahoo/Google, the shortcut button is invalid.

OSD:

Press **OSD** to display the state of the playing file.

MENU:

Press **MENU** to return to main menu. When playing media files through PC or Yahoo/Google, the shortcut button is invalid.

BACK MUSIC:

Press **BACK MUSIC** to play slide show with music in the background.

SLIDE SHOW:

Press **SLIDE SHOW** to continually cycles through all of the pictures in the device.

STEP SHOW:

Press **STEP SHOW** to display a single picture; each press will advance one picture at a time.

EXIT:

Press **EXIT** to stop the current action and return to previous menu.

PLAY/PAUSE:

press to **PLAY** or **PAUSE** a file.

STOP:

press to **STOP** current play back and return to file list.

PREV:

Press **PREV** to skip to the previous title/chapter/track/picture.

NEXT:

Press **NEXT** to skip to the next title/chapter/track/picture.

VOL+/-:

Press the **VOLUME** button to adjust the player's volume.



Chapter 2

Connection

Power Connection	12
Connect to USB Port	13
Memory Card Insertion	14
Memory Card Extraction	15
PC Connecting	16

Digital Photo Frame

Connection

Power Connection

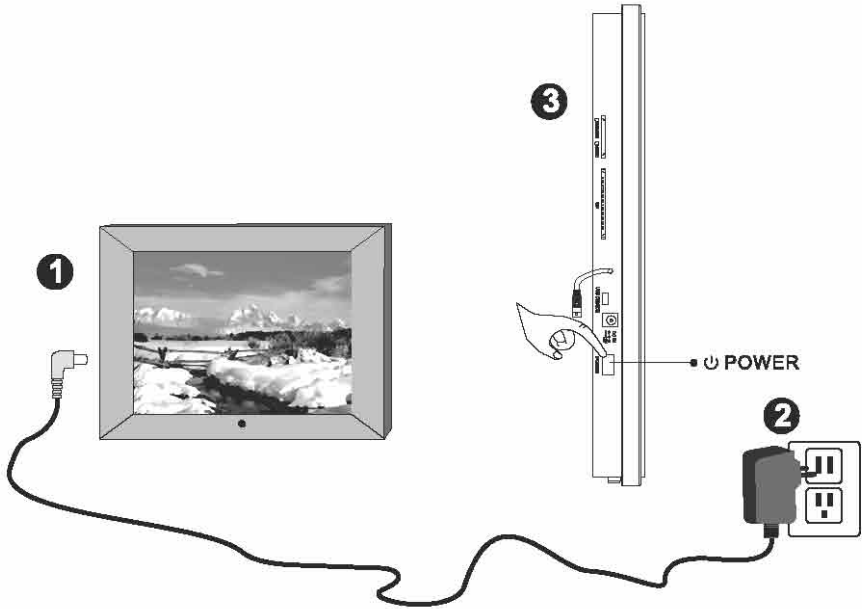

1. Connect the power adapter to the DC 12V jack at the left side of the product.
2. Plug in the power cable.
3. Press POWER to turn the player on .

Digital Photo Frame

Connection

Connect to USB Port

USB HOST: Insert various USB removable storage device or USB WiFi dongle.

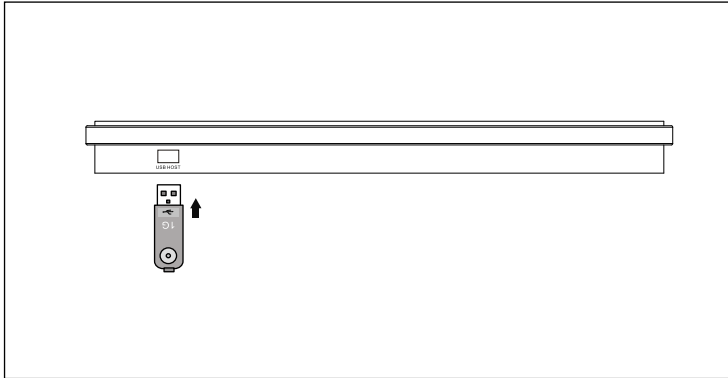

Note: Before connecting the WIFI Dongle or USB removable storage device to the DPF, make sure the attached USB HOST CABLE has been connected to the USB DEVICE.

Digital Photo Frame

Connection

Memory Card insertion

When inserting a memory card into the product, refer to the image to make sure that both the memory card and product are aligned correctly. (The side of the memory card on which the sticker is affixed should face to the front)

Aligning the memory card upside down or to the reverse side may cause damage that is the sole responsibility of the user. (Use of CF ,SD, Memory Stick, MMC cards, XD card enabled)

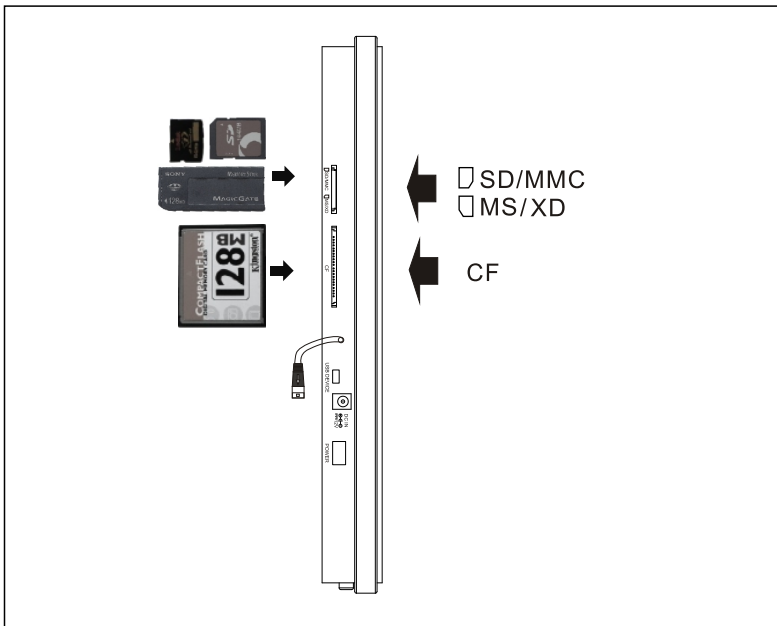

Digital Photo Frame

Connection

Memory Card Extraction

When extracting a memory card, refer to the image and follow directions in extracting the memory card in the direction shown.

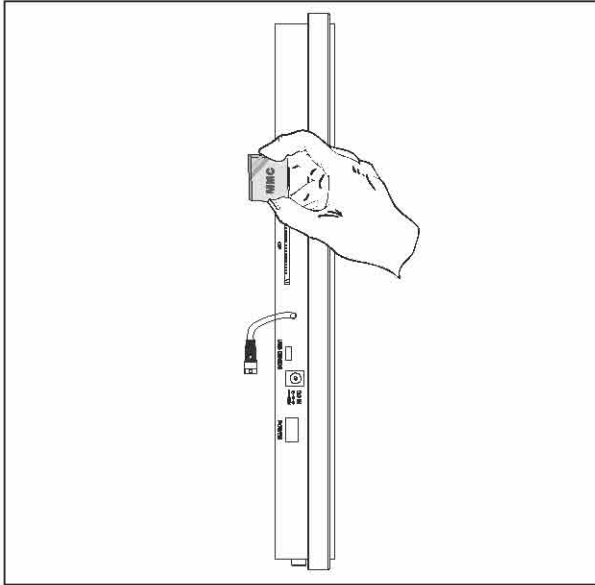

Note: The product will default to the images stored in internal memory when no extra memory card is present, or the product will default to the images stored on the inserted memory card. Press MENU button to return to main menu.

Digital Photo Frame

PC Connecting

Connecting your Multimedia DPF to your PC

Use the supplied USB cable to connect your Multimedia DPF to your PC as the following diagram:

Note: Make sure the attached USB HOST CABLE has been pulled out .

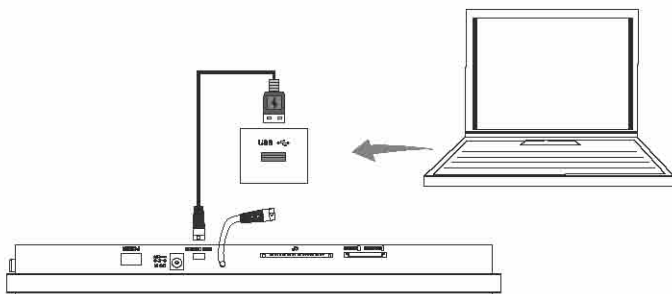

1. After connecting with the PC, the PC's screen will display as the below diagram.
2. Press "OK", then the Pc's screen will display the contents of memory. Then you can copy your required documents from your PC to your Multimedia DPF.
3. After copying the documents, close the window of the " Safely Remove Hardware" on your PC, then pull out the USB cable.
4. Then the Multimedia DPF will run normally.

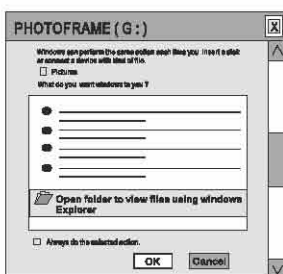

- Note:**
1. When connected to the computer ,the remote keys are inactive.
 2. While transferring documents to the DPF's Internal Memory, you have to restart the DPF to display the document you have transferred.



Chapter 3

Usage

Photo	18
Music	20
Back Music	23
Movie	24
Additional Functions	27

Digital Photo Frame

Photo

Enter into the Photo Directory

Note : press MENU to return main menu.

Select the device icon and press ENTER button to enter into the device menu.

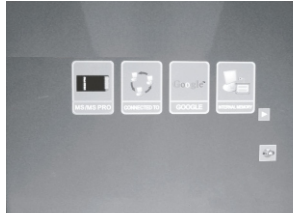

Use the directional keys to select PHOTO icon in the device menu and press ENTER to enter into the 3X5 photos screen.

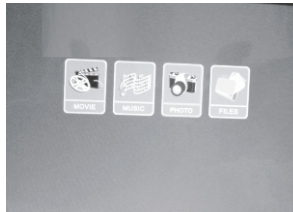

Viewing a Photo in Multi View

You can use the directional keys to select the photo you like, then press ENTER to view it in Multi View. You can also press VIEW to enter the 3X5 screen, then adopt the same operation to view a photo in Multi View .

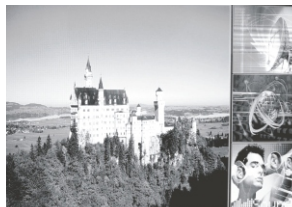

Digital Photo Frame

Photo

Rotating a Photo

After selecting the desired photo , use the **ROTATE** button to rotate(clockwise) the photo to the desired position.



Viewing a Photo in Full Screen

press PHOTO on the remote control , then the player will display the photos in full screen automatically.



Remark

If you have inserted a card in the player, it will first play the PHOTO/MUSIC/MOVIE files on the memory card, or it will default to play the files in the Internal Memory.

Digital Photo Frame

Music

Music

This is the Mp3 player function.

Moving to the Device Directory

Select the device icon and press ENTER button to enter into the device menu.

Moving to the Music Directory

Use the directional keys to select **MUSIC** icon in the device menu and enter into the music file screen.



Selecting a Music File

Use the directional keys to move and select the desired music files.

Digital Photo Frame

Music

Playing the music (PLAY/PAUSE)

After having selected the desired music file, press the PLAY button.

Pausing Music (PLAY/PAUSE)

During playback, press the PLAY/PAUSE button to play or pause the music.



Playing the Music Directly

press MUSIC on the remote control , then the player will play the music stored on the memory cards or in the Internal Memory.

Digital Photo Frame

Music

Adjusting the volume

During playback, use the Vol+ or Vol- buttons to adjust the volume.

Muting the Sound

During playback, Press the Mute button to mute the sound.



NOTE: Only Mp3 format files can be played.

Digital Photo Frame

Back Music

NOTE:

Back music only takes effect during picture playback. When operating on the Internet or on LAN, this function is invalid. Make sure there are **JPEG/JPG** photos on your memory card or **USB** device.

1. Use the navigation buttons on the remote control to select **PHOTO**, then press **ENTER** to enter the 3 X 5 photos screen.

2. Press **BACK MUSIC** to play the photos with music.



Note:
press OSD to operate the state when playing . You can use ◀/▶
to locate and enter Play/Pause/ Stop / Previous/ Fast backward/
Fast forward/ Next on the status bar

Digital Photo Frame

Movie

A variety of movies including digital camera videos, music albums, etc. Can be played.

Select the device icon and press ENTER button to enter into the device menu.

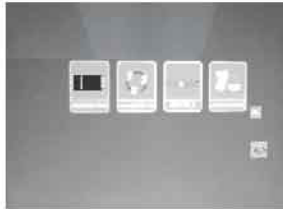

Use the directional keys to select MOVIE icon in the device menu and enter into the movie list.

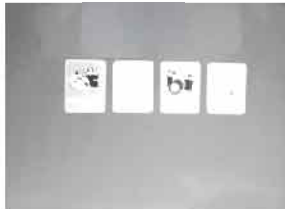

Selecting and Playing a movie (PLAY/PAUSE)

After selecting the desired movie, press either ENTER button or the PLAY/PAUSE button to play the movie.



Digital Photo Frame

Movie

Adjusting the Volume

During playback ,use the VOL(+) or VOL (-) buttons to adjust the volume.

Muting the Sound

During playback, Press the MUTE button to mute the sound.

NOTE: This frame supports the following video file types for direct playback:

- 1.MPEG-1,MPEG-4 (AVI) format files can be played.
- 2.Videos recorded on most digital cameras.



Play the Music Directly

Press MOVIE on the remote control, then the player will play the movie stored on the memory cards or in the Internal Memory.

Digital Photo Frame

Additional Functions

Zoom

During photo playback, Press ZOOM button to magnify the image as follows:

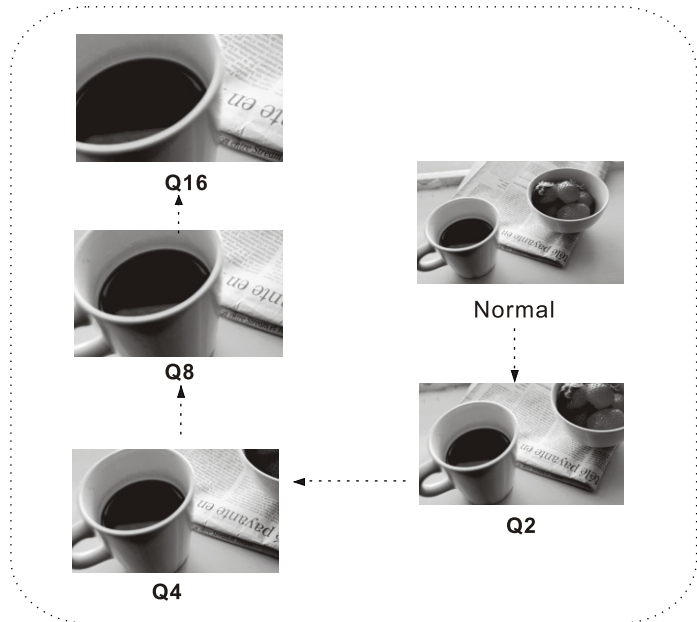
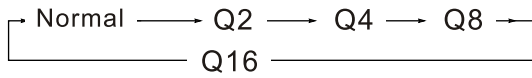

Digital Photo Frame

Additional Functions

SLIDE SHOW

Press **SLIDE SHOW** button.

The photo will automatically slide show one by one.

Note: SLIDE SHOW will only take effect during picture playback.

STEP SHOW:

Press the **STEP SHOW** button, the photo will stop slide show and hold on one picture, then press ◀ or ▶ display the next or previous picture.





Chapter 4

Editing & Settings

Editing	29
Copy file	29
Delete file	31
Settings	32
Language	32
Slide show Duration	33
Slide Repeat Mode	33
Music Repeat Mode	34
Movie Repeat Mode	34
Network	35
RSS	36
Time	36
ALARM	37
Default	37
Calendar	38
WiFi	39

Digital Photo Frame

Editing Files

Editing files

Use the navigation buttons on the remote control to select FILE icon in the device menu and press ENTER to enter into the file list.



A.Copy File

Note: You can not copy files from PC/Googel /Yahoo to the INTERNAL MEMORY.

Use ▲ or ▼ to select the file you want to copy, press ► to select the file and confirm.

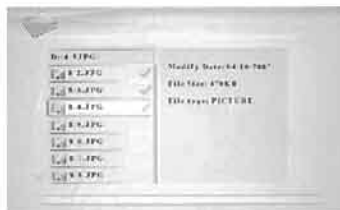

Then press the OSD button and press ENTER to display the memory card information, ENTER to confirm, as follows:



Digital Photo Frame

Edit Files

Then use ▼ or ▲ select memory card and press RIGHT, press ENTER to start transferring the file, as follows:

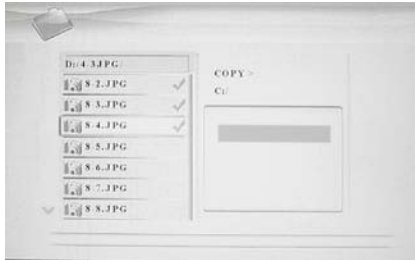

After the file is transferred successfully, the screen shall display as follows:

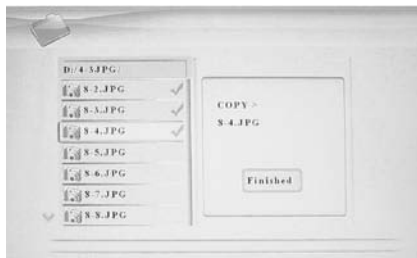

Digital Photo Frame

Edit Files

B.Delete File

Use ▲ or ▼ to select the file you want to delete and press the right arrow key, then press OSD and the screen will display the information as follows:

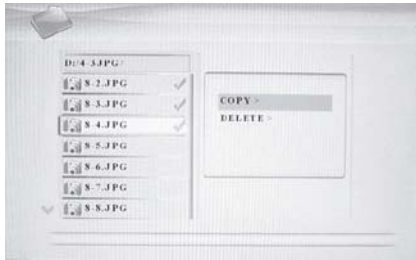

Select **DELETE** and press **ENTER** to start to delete the selected file . The player will delete the file. After deleting the file successfully, the screen will display the information as follows:

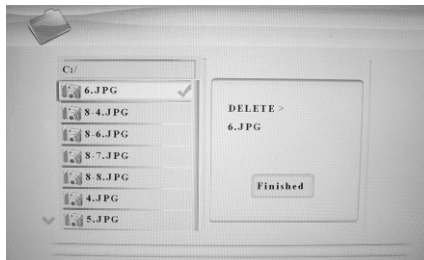

Digital Photo Frame

Setting

Setting

Use the navigation buttons on the remote control to select the “setup” button and press **ENTER**, the screen will display as follows :

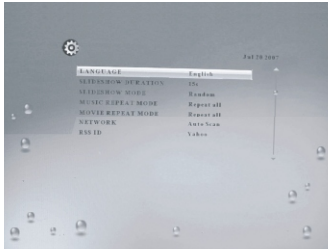

Use ▲ or ▼ to select the menu item you want to set .

LANGUAGE

Press ◀ or ▶ to select LANGUAGE in the setup menu, the only display language is English

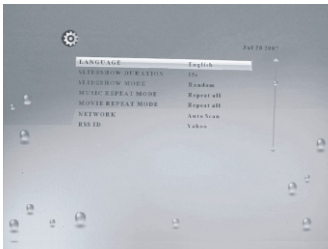

Digital Photo Frame

Setting

SLIDESHOW DURATION

Press ▲ or ▼ to select Slideshow Duration in the setup menu, then press ◀ or ▶ to change your selection (3s/15s/1mins/5mins/1hour)



SLIDESHOW MODE

Press ▲ or ▼ to select Slideshow Mode in the setup menu, then press ◀ or ▶ to change your selection (Off/Bottom_To_Top/Top_To_Bottom/Left_To_Right/Right_To_Left/Door_Close/Door_Open/Hori_Cross/Verti_Cross/Random/Fading).



Digital Photo Frame

Setting

MUSIC REPEAT MODE

Press ▲ or ▼ to select Music Repeat Mode in the setup menu, then press ◀ or ▶ to change your selection (Repeat One/Repeat All)



MOVIE REPEAT MODE

Press ▲ or ▼ to select Movie Repeat Mode in the setup menu, then press ◀ or ▶ to change your selection (Repeat One/Repeat All)



Digital Photo Frame

Setting

NETWORK

Press ▲ or ▼ to select Network in the setup menu, then press ◀ or ▶ to change your selection (Auto Scan/Manual/Disable/Properties).



Digital Photo Frame

Setting

RSS

Press ▲ or ▼ to select RSS in the setup menu, then press ◀ or ▶ to change your selection (Yahoo/Google).

Note: refer to page 39~ 42 for setting instructions

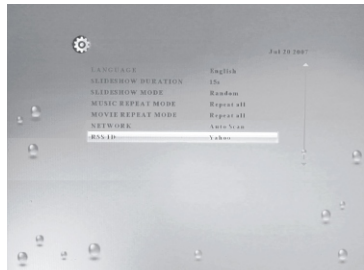

TIME

Press ▲ or ▼ to select Time in the setup menu.

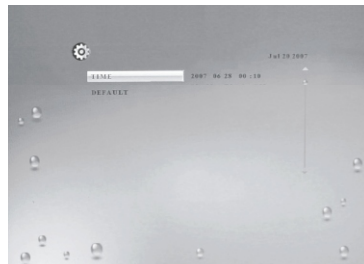

Year: use ◀/▶ to select the “year”, and use ▲/▼ to set the year.
Month: use ◀/▶ to select the “month”, and use ▲/▼ to set the month.
Date: use ◀/▶ to select the “date”, and use ▼/▼ to set the date.
Time: use ◀/▶ to select the “time”, and use ◀/▶ to select hour, minute, and use ▲/▼ to set the time. After setting please press **ENTER** to confirm.

Digital Photo Frame

Setting

ALARM

Select **ALARM** in the **SETTING** menu, press **▶** to set the alarm. Time: Use **◀/▶** to select hour, minute, and use **▲/▼** to set the time.

Ring: Use **◀/▶** to select the "Ring", and use **▲/▼** to select Ring1/Ring2.

MODE: Use **◀/▶** to select the "Mode", use **▲/▼** to select Every/Off/Once to set the alarm periods.



DEFAULT

This item restores the factory default setting as follows:

A: Language is English.

B: Transition Time (Slideshow Duration) is 3s. Transition Mode (Slideshow Mode) is off.

C: Music Repeat Mode and Move Repeat Mode are repeat one.

D: Network is auto scan.



Digital Photo Frame

Setting

Use the navigation buttons on remote control to select “Calendar” icon.
You can view the Calendar and alarm clock.



Display Information:

- Monthly calendar display
- Picture display
- Time display

Press ▼ / ▲ button to change the year display.

Press ◀ / ▶ button to change the month display.

Note: press EXIT you can return to Main Menu.

Digital Photo Frame

Connecting

WiFi

Install Windows media software on your PC

1. Download the Windows Media Player 10(for xp,2000)/ Windows Media Player 11(for vista) from <http://www.microsoft.com/downloads>, then install it on your computer.

2. On Computer, click the menu "Library" in Windows Media player, then a submenu will come down ,click Media Sharing in the submenu ,a window will display as follows :



Take Windows Media Player 11 for example:

On Computer, in Media sharing window , click on the column "sharing my media to",click "setting"to set up the picture/music/vedio files you want to share , click "OK" to confirm.



On Computer, in the submenu of Library ,click "Add to Library",a window of "Add To Library" will display ,click "Advanced Option", then click "Add" to add picture /music/ video files to Windows Media Player ,after adding the desired files ,click "Ok".



3. On Computer, please keep the Windows Media Player working while the computer is connecting with WIFI DPF.

Digital Photo Frame

Setting

3. On **WIFI DPF**, select Main Menu>Setup>Network>Auto Scan/Manual/Disable /Properties.

A. Auto Scan: Automatically get IP address.
Using arrow LEFT or RIGHT button to select Auto Scan, press ENTER button to scan for the wireless network. If IP has a password, the system will prompt you to input the password.

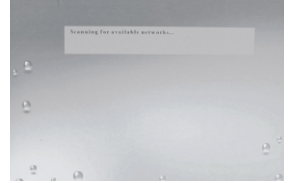

B. **Manual**: Manually Input IP address.
Using a row LEFT or RIGHT button to select **Manual**, press ENTER button to enter the **Manual** setting. Select IP ADDRESS, use the arrow LEFT or RIGHT button to select Static and Dynamic, as the right drawing:

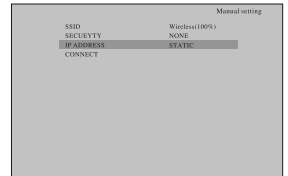

C. Properties: Display the connecting state.
Using arrow LEFT or RIGHT button to select Properties, press ENTER button display the connecting state.



Press ENTER to confirm, the screen will display the IP menu. Please input the IP address, Subnet address, Default gateway, Preferred DNS sever and Spare DNS sever orderly.



If input the IP address correctly, press DONE on the keyboard to return the previous menu, and select Connect>ENTER to scan the wireless network.

If **successful**, the screen will display as the right drawing:

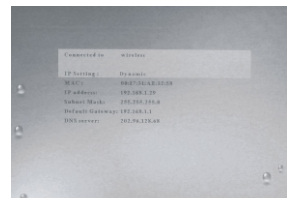

C. Disable : Make the WIFI network disable.

Digital Photo Frame

Setting

Note: When you insert or pull out the WIFI Dongle, Make sure the DPF has been turned off.

Attention!

When using Flickr, please add a tag to all photos you wish to view on your AW15WF, and set the photos as "public".

Press EXIT to the return to main menu, it will increase a "Connect to" icon on the main menu.

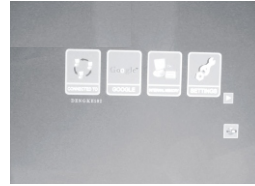

<Picture 1>

Select "Connect to">ENTER, view your PC sharing folder on your frame through your wireless network.

Play Picture: FILE>Picture>All Picture

Play Music: FILE>Music>All Music

Play AVI: FILE>Video>All Video

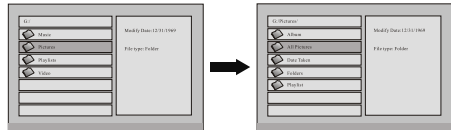

<Picture 2>

4. Set up internet network.

i: In Main Menu interface, Select Setting> RSS > Yahoo/Google> ENTER<Picture 3>.



<Picture 3>

Note: Using arrow LEFT or RIGHT button to select Yahoo or Google. Yahoo-Connect Yahoo to access your Yahoo gallery; Google-Connect Google to access your Google gallery;

ii: Enter into ID/Password item, a key board will display on the screen <Picture 4>, then use the directional keys to input your Yahoo/Google user ID and password and select "Done" on the key board to confirm.

Remark:

Select "Lock" to shift the capital letter and the small letter.

Select "Clear" to clear the ID / Password you have input.

Select "Back" to go back to the previous menu.

Select "Space" to leave a blank between two character when you input the ID / Password.

Note: You only need to input the user name of your Yahoo/Google account .



<Picture 4>

iii: Press "EXIT" on the remote control to go back to the previous menu, then select CONNECT MODE> AUTO MODE/MANUAL > AUTO MODE> ENTER. <Picture 5>

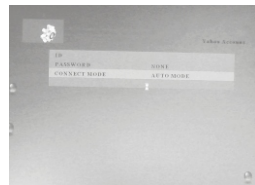

<Picture 5>

Digital Photo Frame

Setting

The player will automatically scan the internet server.

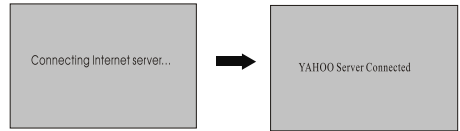

Press EXIT button to return to the main menu, it will increase a Yahoo/Google icon in the main menu.



Select Yahoo / Google > ENTER, view your Yahoo / Google gallery pictures on your frame through the wireless network.

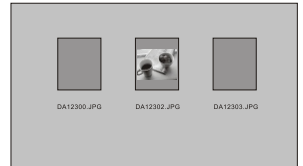

Note: Pictures in Yahoo/Google can't be downloaded to the INTERNAL MEMORY.

While veiwing pictures in Google, in the 3 x 5 photos screen, press ENTER to view the selected picture.

If you can't view the picture, please press EXIT and try again.

Remark: if having trouble in connecting, you can operate as follows:

- Put your frame and your router in the same room.
- Close computer Firewall, as this may affect the wireless connection.
- Keep the Windows Media Connect working while the computer is connecting with WIFI DPF.
- Make sure the computer and WIFI DPF are connected to get IP address.



Chapter 5

Customer Management

Question & Answer	44
Troubleshooting	46
Product Specifications	47
FCC and Safety Information	48

Digital Photo Frame

Question & Answer

Q&A

This chapter will attempt to troubleshoot common problems that one may experience with the Multimedia DPF. If this guide does not solve your problem. Do not dismantle the machine yourself.

Question	Answer
What photo, music, and video formats are supported by the Multimedia Digital Photo Frame?	Photo: JPEG Music: MP3 Video: MPEG-I, MPEG-4(avi, divx or xvid format)
What memory cards are compatible with the digital frame?	Secure Digital Card (SD)/MultiMedia Card (MMC) Memory Stick, CF(Type I, Type II), XD, Memory stick Pro.
How do I store music files?	Use a personal computer and a popular audio editing software such as Music Match to convert your music to MP3 format. Transfer the MP3 file to the memory card by using a Memory Card Reader. Transfer the Mp3 files from pc or USB directly.
Does Multimedia Digital Photo Frame have built-in memory?	Yes. The player has an internal memory to store media file. Its memory volume is 1G. Do not rename the memory's name.
Can I insert multiple memory cards?	Yes, you can insert one CF card with one of SD, MMC, MS, MS Pro, XD at the same time.
Does it play every type of AVI video file?	No. The device only works with the AVI files taken by most digital cameras.
What is the best picture resolution displayed on the screen?	The player's best resolution is 1024(RGB)x768
Can I rotate a picture on the screen?	Yes. Use the ROTATE buttons on the remote control to rotate a picture. Note: The rotated picture will return to its original orientation after you power off the digital frame.
Why Digital picture Frame does not advance to next picture?	1. There is only one picture in the frame. 2. You are viewing high-resolution pictures on the card, High-resolution pictures can take some to display. 3. You are in still display mode. 4. The next picture is damaged.
Why I can not view the pictures of my PC on the frame?	You must insert the USB WIFI dongle included in the accessories, and connect your PC with the frame through a wireless connection.

Digital Photo Frame

Question & Answer

Can I adjust the colors of the picture?	You can adjust the picture display in the video settings in the set up menu. You can also adjust the brightness and contrast, however, this will not alter the contents of your pictures files.
Why can't my PC find the internal memory?	Turn on the multimedia digital photo frame and wait for the function menu to appear, then connect the USB cable from the unit to PC, If the found new device prompt does not appear on your computer screen, look in "my computer" for a USB mass storage device.
Why the unit can't play pictures?	1. Ensure the pictures are stored in the card or USB. 2. The unit only recognizes pictures stored in JPEG, JPG format. 3. If can not play the pictures, please format your card / internal memory
What MPEG-4 formats are supported by the multimedia digital photo frame?	The player can support AVI, DIVX and XVID video file.
Why won't my multimedia digital photo frame play my downloaded music?	The player can only play mp3
Why doesn't the photo cover the entire screen?	The resolution required for a picture to cover the entire screen must be greater than 1024x768 pixels.
Can the DPF player connect with all computers?	No. the USB port of the PC connected with the player must be USB 2.0, and the PC must be windows system (eg. windows 2000, windowsXP.etc).

Digital Photo Frame

Troubleshooting

If you have any questions, please consult the troubleshooting guide below. Some simple checks or a minor adjustment on your part may eliminate the problem and quickly resolved .

No power

- Ensure the power button is on
- Ensure the power cord is not damaged
- Ensure the power plug is connected firmly to the outlet

Could not read the card

1. Please copy the content in your card to your PC, then format your card, then pass your photos/music/movies in your card again, then insert the card to DPF .
2. Ensure the card is not damaged
3. Ensure the card is connected to the DPF correctly
4. Ensure the card has content(photo/music/movie), if no content in card, the screen will display "Files can't be found"

Remote control not working

1. Ensure the batteries are inserted
2. Ensure the batteries "protective plastic" is pulled out.

Note: Long term connecting to internet without any operation may lead image shiver or dark screen. Turn off power, then turn on, it will recover.

Digital Photo Frame

Product Specifications

Specifications can be changed without prior notice in the interest of improving product performance.

Product Specifications

Item		Details
LCD Display	Size	15.4 Inch(Diagonal)
	Resolution	1024(Horizontal)*768(Vertical)
	Brightness	350cd /m²
	Contrast Ratio	400:1
Memory	Internal Memory	1GB
	Compatible Memory Cards	CF / SD / MMC / Memory Stick / XD
Remote Control		27Keys
Support Media Formats	Images	JPEG(jpg)
	Video	AVI, MPEG-1(mpg/dat), MPEG-4,
	Audio	Mp3
Internal Speaker	Stereo	3W+3W
Power	Adapter	Input: 100~240V AC, Output: 12V, 3ADC
	Electricity Consumption	18W (Operating)
Size	Width*Height*Depth	420(w)*350(h)*55(d)[mm]
Weight	Kg	3.2
USB Connection	USB Device	USB HOST(2.0)

Digital Photo Frame

FCC and Safety Information

• FCC Part 15.19

This device complies with Part 15 of the FCC Rules. Operation is subject to the following two conditions: (1) this device may not cause harmful interference. (2) this device must accept any interference received, including interference that may cause undesired operation.

• FCC part 15.21

Warning: Changes or modifications to this unit not expressly approved by the party responsible for compliance could void the user's authority to operate the equipment.

• FCC part 15.105

Note : This equipment has been tested and found to comply with the limits for a Class B digital device, pursuant to Part 15 of the FCC Rules, These limits are designed to provide reasonable protection against harmful interference in a residential installation. This equipment generates, uses, and can radiate radio frequency energy.

And if not installed and used in accordance with the instructions, may cause harmful interference will not occur in a particular installation. If this equipment does cause harmful interference to radio or television reception, which can be determined by turning the equipment off and on, the user is encouraged to correct the interference by one or more of the following measures:

- Reorient or relocate the receiving antenna.
- Increase the separation between the equipment and receiver.
- Connect the equipment into an outlet on circuit different from that to which the receive is connected.
- Consult the dealer or an experienced radio TV technician for help.

LIMITED WARRANTY

The limited warranty set forth below is given by Sungale Group Inc. ("SGI") with respect to Sungale brand DPF players and other consumer electronics products purchased and used in the United States of America. SGI warrants this product against defects in material or workmanship as follows:

LABOR: For a period of ninety (90) days from the date of purchase, if this Product is defective, SGI will repair or replace the Product, at its option, at no charge. After this ninety (90) days period up to one year, a labor charge of US\$30.00 will be charged for each service.

PARTS: For a period of one year from the date of purchase, SGI will supply, at no charge, new or rebuilt replacement parts in exchange for defective parts. After this one year period, SGI will charge the new or replacement parts.

This warranty does not cover: (1) customer instruction, installation or set up; (2) cosmetic damage or damage due to accident, misuse, abuse, or negligence; (3) commercial use of the Product; (4) modification of any part of the Product; (5) damage due to improper operation, improper maintenance, or connection to an improper voltage supply; (6) damage due to an attempted repair of the Product by anyone other than a facility authorized by SGI to service the Product; (7) consumables (such as fuses and batteries). This warranty is valid only in the United States.

The product must be accompanied by a copy of the original retail purchase receipt. If no proof of purchase is attached, the warranty will not be honored and repair cost will be charged.

This warranty is valid with attach written documentation detailing the complaint to the outside or inside of the carton.

This warranty is invalid if the factory applied serial number has been altered or removed from the Product.

SGI reserves the right to modify any design of this product without prior notice.

To obtain warranty service, you must deliver the product freight prepaid, in either its original packaging or packaging affording an equal degree of protection, plus proof of purchase, to:

Service Center
13358 Monte Vista Avenue,
Chino, CA 91710
Tel: **800-473-5156**

REPAIR OR REPLACEMENT AS PROVIDED UNDER THIS WARRANTY IS THE EXCLUSIVE REMEDY OF THE CONSUMER. SGI SHALL NOT BE LIABLE FOR ANY INCIDENTAL OR CONSEQUENTIAL DAMAGES FOR BREACH OF ANY EXPRESS OR IMPLIED WARRANTY ON THIS PRODUCT. EXCEPT TO THE EXTENT PROHIBITED BY APPLICABLE LAW, ANY IMPLIED WARRANTY OF MERCHANTABILITY OR FITNESS FOR A PARTICULAR PURPOSE ON THIS PRODUCT IS LIMITED IN DURATION TO THE DURATION OF THIS WARRANTY.

Some states do not allow the exclusion or limitation of incidental or consequential damages, or allow limitations on how long an implied warranty lasts, so the above limitations or exclusions may not apply to you. This warranty gives you specific legal rights, and you may have other rights which vary from state to state.

Digital Photo Frame

Sungale

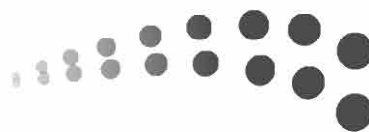

Free Manuals Download Website

<http://myh66.com>

<http://usermanuals.us>

<http://www.somanuals.com>

<http://www.4manuals.cc>

<http://www.manual-lib.com>

<http://www.404manual.com>

<http://www.luxmanual.com>

<http://aubethermostatmanual.com>

Golf course search by state

<http://golfingnear.com>

Email search by domain

<http://emailbydomain.com>

Auto manuals search

<http://auto.somanuals.com>

TV manuals search

<http://tv.somanuals.com>