

Guardian Aspire Service Manual



©2003 Sunrise Medical Inc.
931157 Rev A

Guardian Aspire Troubleshooting Guide

INTRODUCTION	0.1
---------------------------	-----

Specifications

VSI Controller	0.2
Plugs/Connectors.....	0.3
Main Wiring Diagram/Tool List.....	0.4

Troubleshooting - No PowerSection 1

Step 1.0 Circuit Breaker Reset	1
Step 1.1 Test Joystick	1
Step 1.2 Battery Test	1
Step 1.3 Recharging the Batteries.....	2
Step 1.4 Not Charging	2
Step 1.5 Battery Connection Check	2
Step 1.6 Battery Wire Harness	3
Step 1.7 Battery Fuse	3
Step 1.8 Circuit Breaker Test.....	3
Step 1.9 Main Harness	3

Understanding Controller DisplaySection 2

2.1 Maximum Speed Indicator Ripples.....	4
2.2 Maximum Speed Indicator Flashes	4
2.3 Battery Gauge is Steady.....	4
2.4 Battery Gauge Flashes Slowly	4
2.5 Battery Gauge Steps Up.....	4
2.6 Battery Gauge Blinks Every 2.5 Seconds	4
2.7 Battery Gauge Flashes Rapiily.....	4

Understanding VSI Controller Diagnostics CodesSection 3

3.1 1 Bar (1 Red) Low Battery Voltage	5
3.2 2 Bars (2 Red) - Left Motor Disconnected	5
3.3 3 Bars (3 Red) - Left Motor Wiring Trip	6
3.4 4 Bars (3 Red, 1 Yellow) Right Motor Disconnected	7
3.5 5 Bars (3 Red, 2 Yellow) Right Motor Wiring Trip.....	8
3.6 7 Bars (3 Red, 4 Yellow) Possible Joystick Trip	9
3.7 8 Bars (3 Red, 4 Yellow, 1 Green) Possible Control System Trip	9
3.8 9 Bars (3 Red, 4 Yellow, 2 Green) Solenoid Brake Trip	9
3.9 10 Bars (3 Red, 4 Yellow, 3 Green) High Battery Voltage	10

Disassembly/Reassembly and Adjustment.....Section 4

Step 1 (Controller and Seat)	11
Step 2 (Cog Release)	12
Step 3 (Seat Posts).....	12
Step 4 (Shroud).....	13
Step 5 (Front Caster Cover)	14
Step 6 (Charger)	15
Step 7 (Battery).....	15
Step 8 (Motor/Wheel).....	16
Step 9 (Motor Mounts)	17
Step 10 (Front and Rear Caster Assembly).....	18
Step 11 (Wire Harnesses).....	19

INTRODUCTION

Please read and follow instructions in this service manual before attempting to troubleshoot or repair this product for the first time. If there is anything in this Service Manual that is not clear, or if you require additional Technical assistance, contact Sunrise Medical at: (800) 333-4000 option 2, then option 1.

Safely troubleshooting and/or repair of this product depends on your diligence in following the instructions within this manual. Sunrise Medical is not responsible for injuries or damage resulting from a person's failure to exercise good judgement and/or common sense.



There are warning symbols used in this document to focus attention on any hazard that could effect the safety of the individual troubleshooting the chairs covered in this Service Manual.



This Service Manual has been compiled as a troubleshooting guide for the Guardian Aspire. Photographs and content may differ from the actual products in some cases due to changes in specifications and other factors.

This Service Manual is intended for use by persons with a basic working knowledge and the skills required in servicing and maintaining Power Wheelchairs. Persons without a General Working knowledge and expertise in the servicing of this product should not carry out troubleshooting procedures. This can result in problems with future servicing, and/or damage to the unit.

Parts and configuration or specifications of Products included in this Service Manual are subject to change without prior notice.

VSI Controller

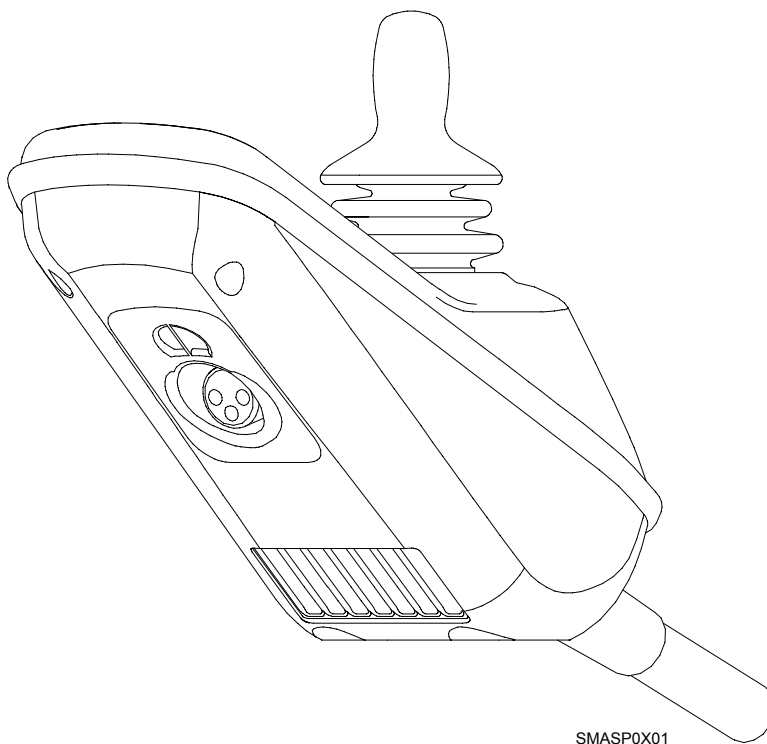

VSI Controller



VSI Controller Buttons

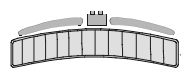

Battery Condition Meter- A series of ten LED's, which indicate charge level.



Speed/Profile indicator- A series of five LED's, which display speed and profile settings



On/Off Key- Press to power on or off the power chair or Controller.



Horn Key- Activates a warning horn.



Speed/ Profile Decrease. Used to decrease the Speed/ Profile setting.



Speed/ Profile Increase. Used to Increase the Speed/ Profile setting.

CNTRLLR BTNS

Plugs/Connectors

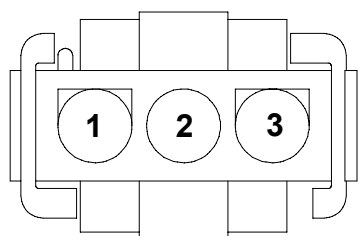

1 = 0 Vdc
 2 = Inhibit 3
 3 = 24 Vdc

3-pin connect
 Outside View

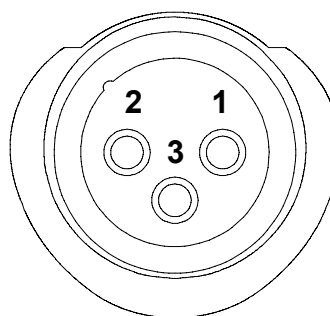

1 = 24 Vdc
 2 = 0 Vdc
 3 = Inhibit 1/ Programmer

Charger port
 Outside View

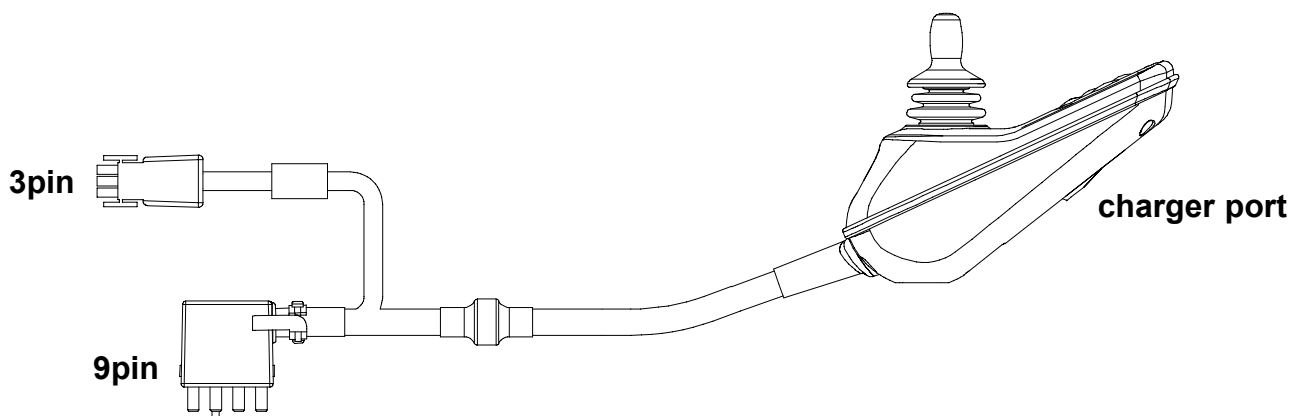

Controller and Harness

+24 Vdc Solenoid Brake Input

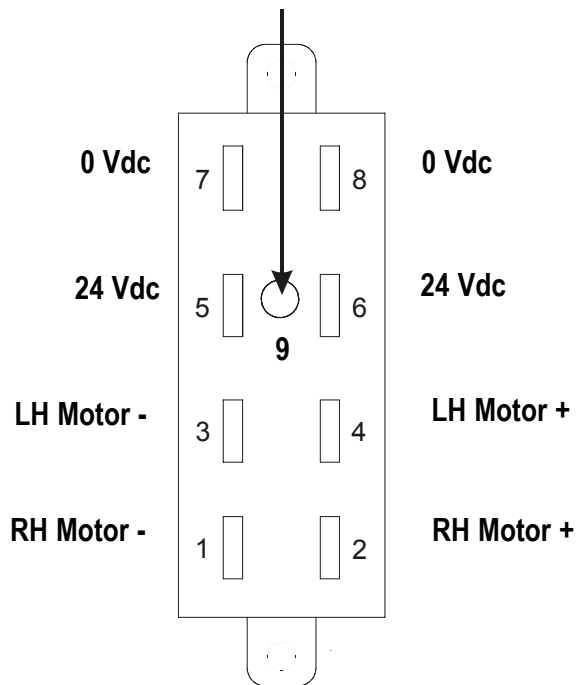

9-pin Connect Harness Socket Face

Motor Plug

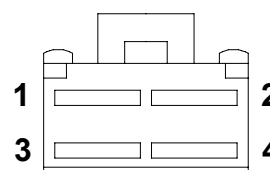

4-pin connect

1 = Brake Solenoid
 2 = Brake Solenoid
 3 = Motor
 4 = Motor

Main Wiring Diagram/Tool List

Wiring Diagram

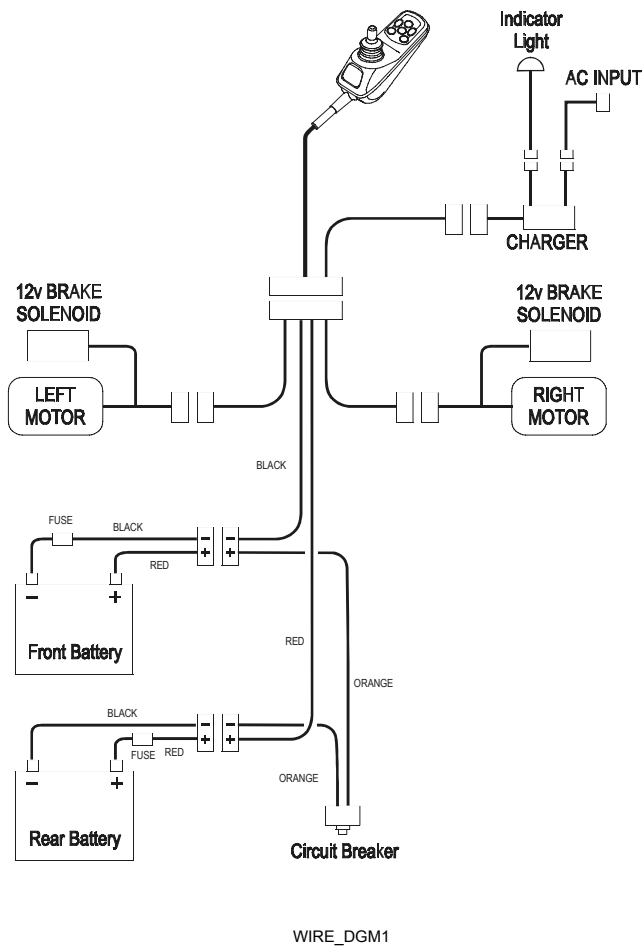

Basic Tool List

For correct maintenance, adjustment, and for disassembly/reassembly of the power chair you will need the following tools:

1. 3mm Allen wrench
2. 5mm Allen wrench
3. 13mm Open-end wrench
4. 13mm Socket wrench
5. 16mm Open-end wrench
6. 17mm Deep Socket wrench
7. 19mm Open-end wrench
8. Phillips screwdriver #2
9. Flat blade screwdriver
10. Cutter for the zip-tie

Section 1

Troubleshooting: No Power

1.0 Circuit Breaker Reset

If On/off button is pressed and no light or bar is shown, check for tripped circuit breaker (see figure A1.0.1) and make sure all connections are clean and tight (including the batteries). If the problem persists, then perform the following diagnostics.



1.1 Test Joystick

Check that the voltage is going to the controller, set the meter to dc volts and take a voltage reading from pin 1 (using the red lead) and pin 2 (using the black lead) to the charger port of the VSI controller (see figure A1.1.1) If the voltage meter reads approximately 24 volts, replace the controller, if the meter reads less than 12 volts, proceed to the next step.

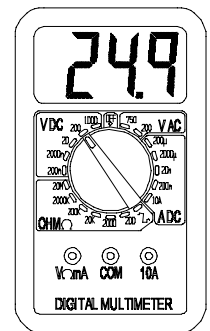
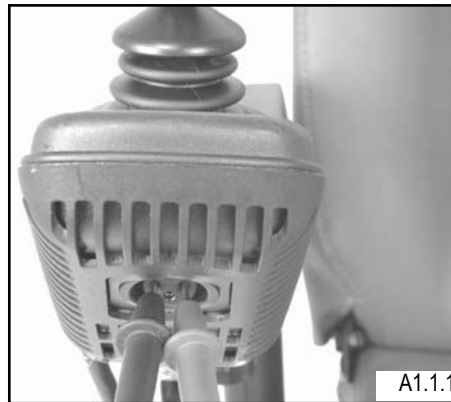

Note: Make sure the polarity is correct. If the reading is intermittent, there is a connection or Controller problem. If polarity is reversed proceed to step 1.6

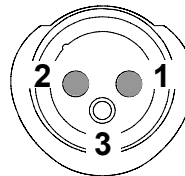

- **If the total Battery Voltage reads approx. 24 V, and the Polarity is correct, replace the controller.**

1.2 Battery Test

Check that the batteries are fully charged and in good condition. Remove the seat, and the battery cover, with controller connected and turned on, use the meter to check the voltage across the battery terminals (see figure A1.2.1). If the voltage meter reads between 12 -13.5 volts, then proceed to next step. If the voltage meter reads below 12volts, charge the batteries.



Note: To find a bad battery, use a battery load tester.

- **If the voltage meter reads below 12 volts, charge the batteries.**

1.3 Re-Charging the Batteries

If the total Battery voltage is less than 8 Volts, charge each Battery separately with a 12 Volt Trickle Charger for a few hours. This should bring the voltage back up to the level that the On-Board Charger will activate.

1.4 Not Charging

Check the charger indicator light in the front shroud. If it is not lighted, check the connection from the light to the charger. Check the Circuit Breaker Box and make sure it is not tripped. Make sure the 3 pin Charger plug is connected properly and is in good condition. Check all batteries and harness connections following steps 1.2 and 1.5 - 1.9 Check the connection from the A/C charging outlet to the charger. If none of these actions have corrected the problem, then replace the charger.

Note: On Board Charger Indicator Light shows Amber color when charging, and Green when fully charged.

1.5 Battery Connection Check

Check that the female Beau plug on the chair has voltage. Set the meter to dc volts and measure pins 5 (using the red lead of the meter) and 7 (using the black lead of the meter) as shown in (figure A1.5.1).

If the voltage meter reads full voltage, then measure pins 6 (using the red lead of the meter) and 8 (using the black lead of the meter) as shown in (figure A1.5.2). If both the measurements read full voltage, then replace the controller, or else proceed to the next step.

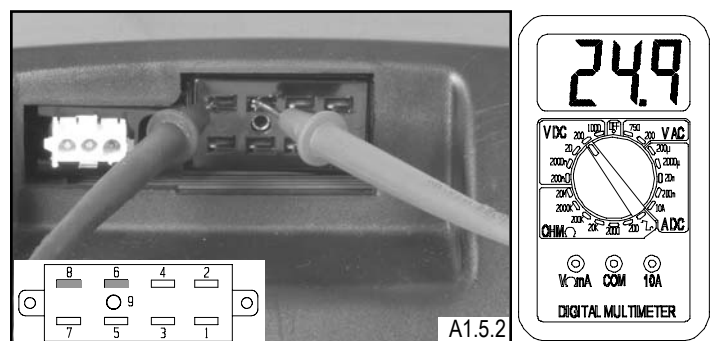
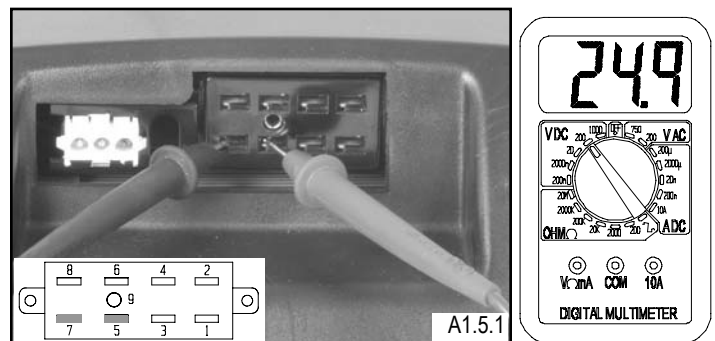

- **If both of the measurements read full voltage, then replace the controller.**

1.6 Battery Wire Harness

Check that the battery wire harness has the polarity correct. Set the meter to dc volts and measure the connector with the red lead on the red wire contact (top of the connector) and the black lead on the black wire contact (bottom of the connector) as shown in (figure A1.6.1). If both battery wire harnesses have full voltage and correct polarity, then proceed to step 1.8. If voltage is absent proceed to step 1.7. If polarity is reversed correct battery wiring.

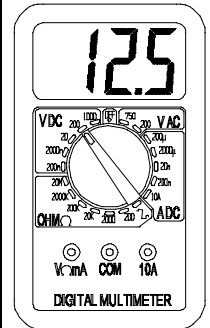

- **If polarity is reversed correct battery wiring.**

1.7 Battery Fuse

Check that the battery fuse is in good condition. With the batteries disconnected remove the fuse cap, inspect the fuse to see if the fuse is blown. To make sure the fuse is not blown, set the meter to ohms and measure the resistance across the fuse. see (figure A1.7.1). If the meter reads more than one ohm, change the fuse, or else proceed to the next step.

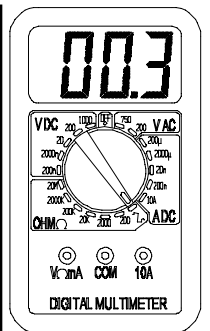
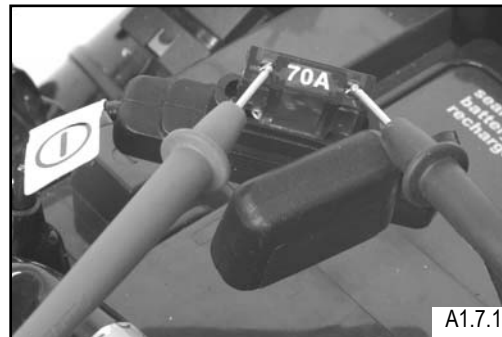

- **If the meter reads more than one ohm, change the Battery fuse.**



1.8 Circuit Breaker Test



To check the circuit breaker set the meter to ohms and measure the resistance across the circuit breaker as shown in (figure A1.8.1). If the meter reads more than 1 ohm, then change the circuit breaker, otherwise proceed to next step.

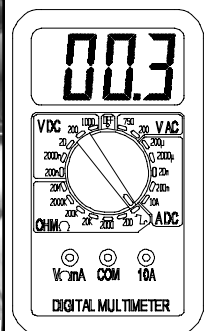

- **If the meter reads more than 1 ohm, then change the circuit breaker.**

1.9 Main Harness

If the above steps did not correct the problem, change the main harness.

- **If the previous steps did not correct the problem, change the main harness.**

Section 2

Understanding Controller Display

2.1 *The Maximum Speed Indicator Ripples*

The wheelchair is locked. To unlock the wheelchair, deflect the joystick forwards until the control system chirps. Then deflect the joystick in reverse until the control system chirps. Release the joystick, there will be a long beep. The wheelchair is now unlocked.

To lock the wheelchair, while the control system is switched on, depress and hold the on/off button. After 1 second, the control system will chirp. Now release the on/off button, deflect the joystick forwards until the control system chirps, and deflect the joystick in reverse until the control system chirps. Release the joystick, there will be a long beep. The wheelchair is now locked.

2.2 *The Maximum Speed Indicator Flashes*

This indicates that the chair is charging via on-board charger. The chair will be ready to drive as soon as the charger is unplugged.

2.3 *Battery Gauge is Steady*

This indicates that all is well.

2.4 *Battery Gauge Flashes Slowly*

The control system is functioning correctly, but you should charge the battery as soon as possible.

2.5 *Battery Gauge Steps Up.*

the wheelchair batteries are being charged with the offboard charger. You will not be able to drive the wheelchair until the charger is disconnected and you have reset the control system by switching off the power and then powering up again.

2.6 *Battery Gauge Blinks Once Every 2.5 Seconds*

The control system has "gone to sleep" because the wheelchair has not been driven for a period of time. The time period depends on the programming of the system. To re-start, reset the system by switching off the power and then powering up again.

2.7 *Battery Gauge Flashes Rapidly (even with the joystick released)*

The control system safety circuits have been activated and the control system has been prevented from moving the wheelchair. This indicates a system trip, i.e. the VSI has detected a problem somewhere in the wheelchair's electrical system. Please refer to Section 3 (VSI Controller Diagnostics).

Section 3

Understanding VSI Controller Diagnostics Codes

3.1 One Bar - Low Battery Voltage

This code could indicate discharged batteries, failed batteries, or poor battery connections. Begin by recharging the batteries and then refer to Section 1 to check batteries and connections.

3.2 Two Bars - Left Motor Disconnected

The left hand motor has a bad connection. Check the connections to the left hand motor.

Test Left Motor Open

Check that the batteries are fully charged and in good condition; and check all cables and connections. Check the connections to the left motor, look for a loose or damaged connector. Remove the 9-pin Beau plug and check the resistance across pin 3 and pin 4 as shown in (figure A3.2.1). If the meter reads between 0 to 1.5 ohms, then replace the controller.

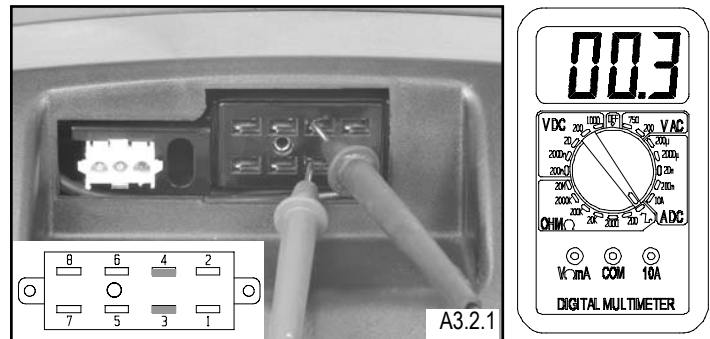

- **If the meter reads between 0 to 1.5 ohms, then replace the controller.**

Otherwise, check the brushes on the left motor. Ensure that they are not excessively worn, (replace as required) as shown in (figure A3.2.2).



Use the meter to check the resistance across the two bottom contacts (thicker wires) on the 4-pin motor connector as shown in (figure A3.2.3). If the meter reads between 0 to 1.5 ohms, then replace the main harness. If none of the above corrects the problem, replace the left motor.

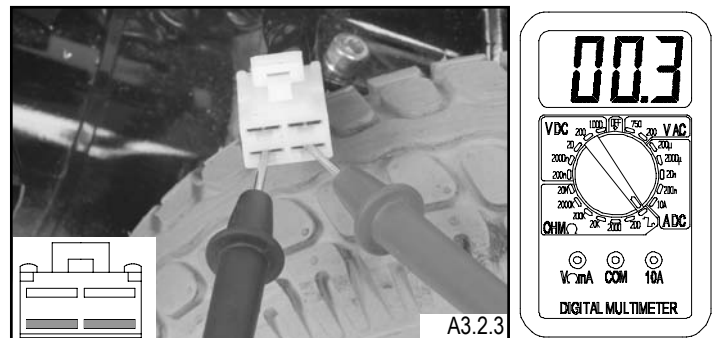

- **If the meter reads between 0 to 1.5 ohms, then replace the main harness.**
- **If none of the above corrects the problem, replace the left motor.**

Understanding VSI Controller Diagnostics Codes (cont.)

3.3 Three Bars - Left Motor Wiring Trip

The left hand motor has a short circuit to a battery connection.

Test Left Motor Short

Check that the batteries are fully charged and in good condition; and check all cables and connections. Check the connections to the left motor, look for a loose or damaged connector. Take a resistance reading from pin 3 to pin 9 and pin 3 to pin 7 or pin 8, see (figure A3.3.1) and (A3.3.2), if all the circuits are open (resistance is greater than 10 K ohm), then replace the controller. If the reading is short (resistance is less than 10 K ohm), proceed to check the 4-pin motor connector.

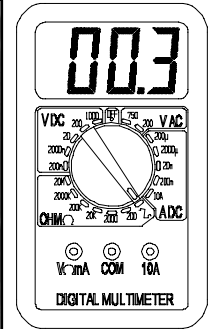
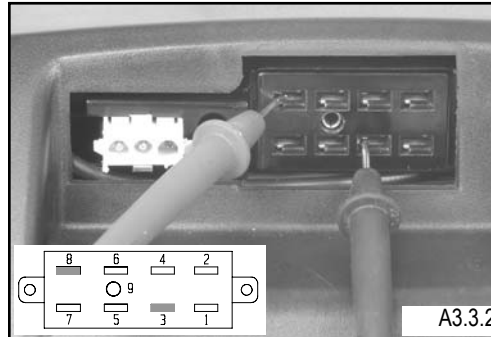
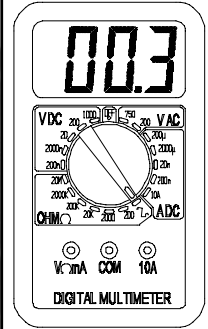
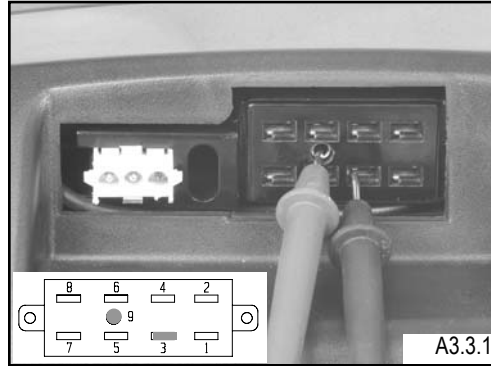

- **If all the circuits are open (resistance is greater than 10 K ohm), then replace the controller.**

Measure the resistance from the bottom contact of the red thick wire on the 4-pin left motor connector to each of the top contacts of the connector see (figure A3.3.3). Measure the resistance from the bottom contact of the black thick wire on the 4-pin left motor connector to each of the top contacts of the connector see (below right). If all of the readings are open, then replace the main harness. If any of the readings are short, then replace the left motor.

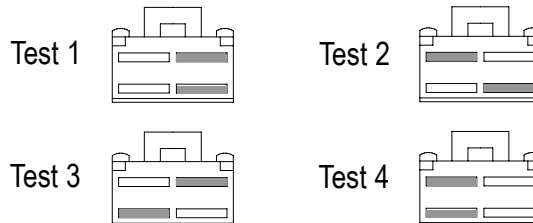
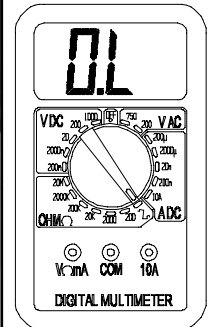
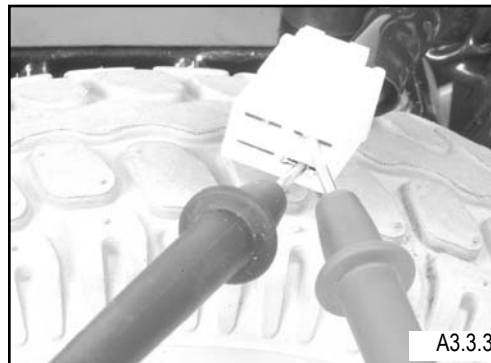

- **If all of the readings are open, then replace the main harness.**
- **If any of the readings are short, then replace the left motor.**

Understanding VSI Controller Diagnostics Codes (cont.)

3.4 Four Bars- Right Motor Disconnected

The right hand motor has a bad connection. Check the connections to the right hand module.

Test Right Motor Open

Check that the batteries are fully charged and in good condition, and check all cables and connections. Check the connections to the right motor, look for a loose or damaged connector. Remove the 9-pin Beau plug and check the resistance across pin 1 and pin 2 as shown on (figure A3.4.1). If the meter reads between 0 to 1.5 ohms, then replace the controller.

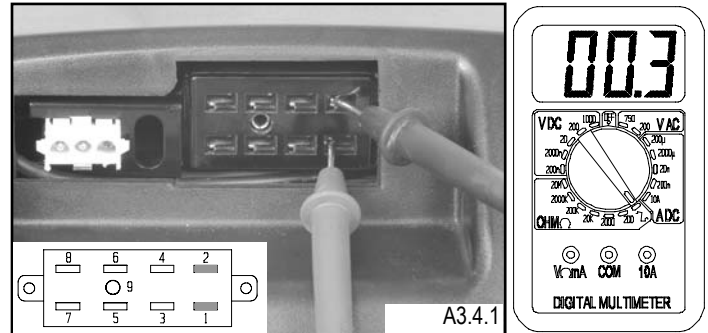

- **If the meter reads between 0 and 1.5 ohms, then replace the controller.**

Otherwise, check the brushes on the right motor. Ensure that they are not excessively worn, (replace as required) as shown in (Figure A3.4.2).



Use the meter to check the resistance across the two bottom contacts of the thicker wires on the 4-pin motor connector as shown in (figure A3.4.3). If the meter reads between 0 to 1.5 ohms, then replace the main harness. If none of the above corrects the problem, replace the right motor.

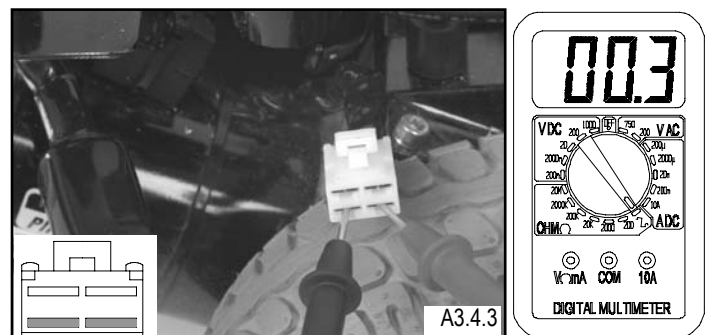

- **If the meter reads between 0 and 1.5 ohms, then replace the main harness. If this does not correct the problem, then replace the right motor.**

Understanding VSI Controller Diagnostics Codes (cont.)

3.5 Five Bars - Right Motor Wiring Trip

The right hand motor has a short circuit to a battery connection.

Test Right Motor Short

Check that the batteries are fully charged and in good condition, and check all cables and connections. Check the connections to the right motor, look for a loose or damaged connector. Take a resistance reading from pin 2 to pin 9 see (figure A3.5.1). Take a resistance reading from pin 2 to pin 7 or pin 8 see (figure A3.5.2), if all the circuits are open (resistance is greater than 10K ohms), then replace the controller.

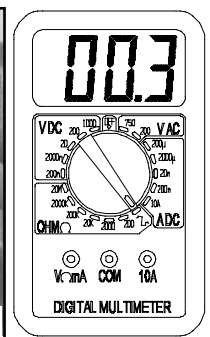
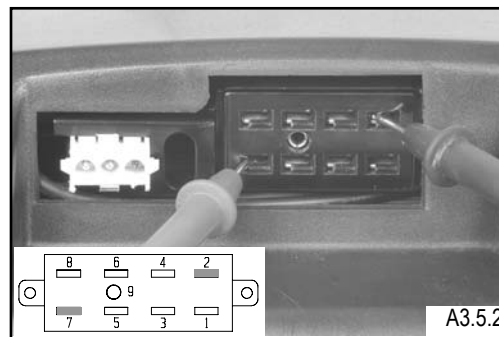
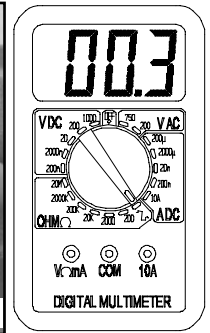
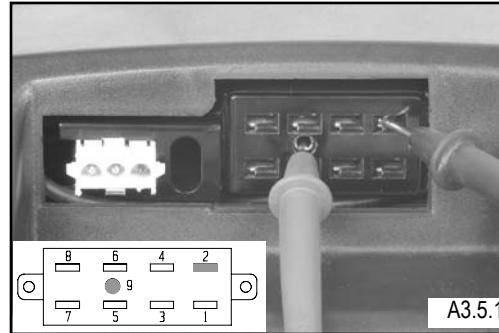

- **If all the circuits are open (resistance is greater than 10K ohms), then replace the controller.**

If the reading is short (resistance is less than 10 K ohms) on any of the readings, proceed to check the 4-pin motor connector. Measure the resistance from the bottom contact of the red thick wire on the 4-pin right motor connector to each of the top contacts of the connectors see (figure A3.5.3). Measure the resistance from the bottom contact of the black thick wire on the 4-pin right motor connector to each the top contacts of the connector (below right). If all of the readings are open, then replace the main harness. If any of the readings are short, then replace the right motor.

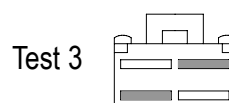
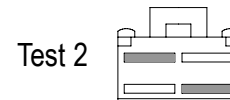
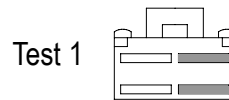
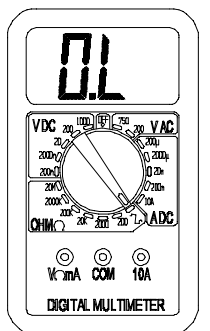
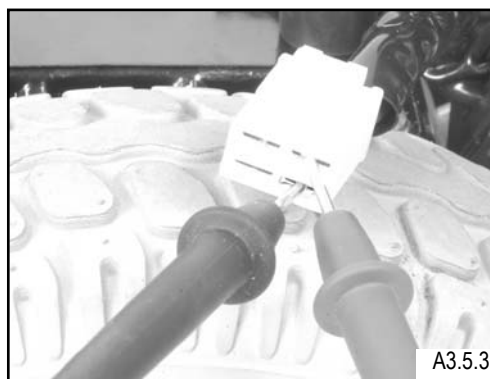

- **If all of the readings are open, then replace the main harness.**
- **If any of the readings are short, then replace the right motor.**

Understanding VSI Controller Diagnostics Codes (cont.)

3.6 Seven Bars - Possible Joystick Trip

A joystick trip is indicated. Make sure that the joystick is in the center position before switching on the control system.

Check that the batteries are fully charged and in good condition, examine the joystick for damage. This fault can be caused by a joystick that fails to center itself due to being dirty, bent or broken. If this is the case, replace the controller.

- ***If the joystick fails to center because it is bent or broken, replace the controller***

3.7 Eight Bars - Possible Control System Trip

A control system trip is indicated. Make sure that all connections are secure.

Controller Fault

Check that the batteries are fully charged and in good condition, and check all joystick connections and cables. If this does not correct the problem, then replace the controller.

3.8 Nine Bars - Solenoid Brake Trip

Brake Fault

The parking brakes have a bad connection. Check the parking brake and motor connections. Make sure the control system connections are secure.

Brake Fault

Check battery connections and cables. Set the meter to ohms and measure the resistances from pin 9 to pin 7 of the 9-pin beau plug see (figure A3.8.1.) Measure the resistance from pin 9 to pin 8 of the 9 pin Beau connector see (figure A3.8.2). If both readings are approximately 30 ohms, replace the controller.

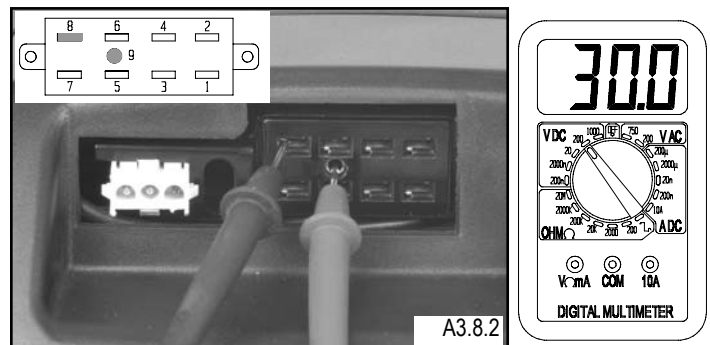
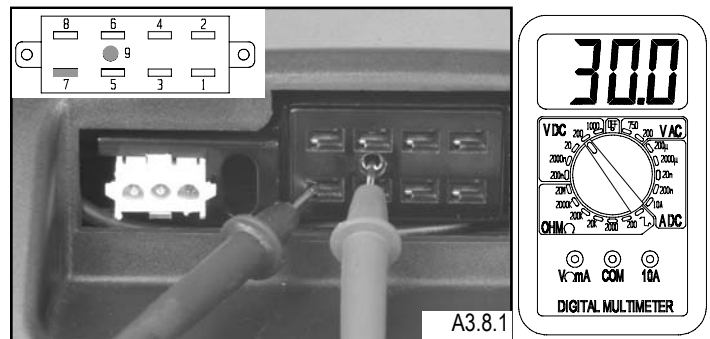

- ***If both readings are approximately 30 ohms then replace the controller***

Understanding VSI Controller Diagnostics Codes (cont.)

3.8 Nine Bars - Solenoid Brake Trip (cont.)

Test Motor Connections

If either or both readings are incorrect, then measure the resistance on the two small contacts on the 4-pin motor connector see (figure A3.8.3). If both motor connectors read approximately 60 ohms, then replace the main harness. Otherwise, replace the motor that does not read approximately 60 ohms.

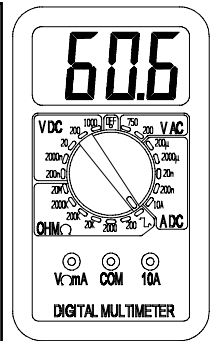
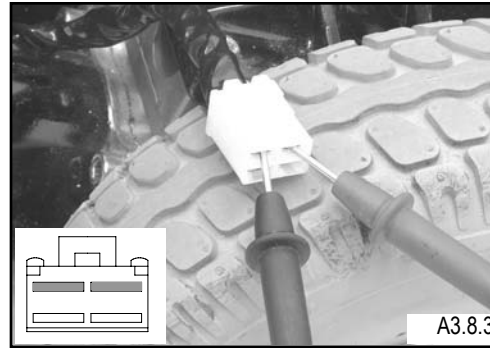

- **If both motor connectors read approximately 60 ohms, then replace the main harness. Otherwise, replace the motor that does not read approximately 60 ohms.**

3.9 Ten Bars - High Battery Voltage

An excessive voltage has been applied to the control system. This is usually caused by a poor battery connection. Check the battery connections.

Battery Fault

Check that the batteries are fully charged, the correct voltage and in good condition. Take a voltage reading from pin 1 and pin 2 of the charger port of the VSI controller, see (figure A3.9.1) If the meter reads more than 30 volts, then check the charger. Otherwise, replace your controller.

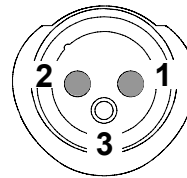
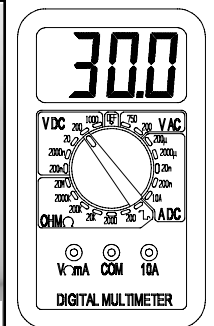

- **If the meter reads more than 30 volts replace the charger,**
- **If the Batteries, connections, and voltage level are correct replace the controller.**

Section 4

Disassembly/Reassembly, and Adjustment

Step 1 - Controller and Seat

Note: When using the terms “Right Hand, Left Hand” this is referenced as if seated in the chair.

Disassembly

- a. Squeeze down the locking legs of the 3 pin charger plug and unplug it from the rear of the chair. (figure s1.1).
- b. Rock the controller plug back and forth until it is loose and then unplug it (figure s1.1).

Note: Remember to lay cables on the seat otherwise they may become tangled when taking off the seat.

- c. Pull out the safety pin from the left front seat post (figure s1.2).
- d. Tilt the seat back, slide it forward, and lift it off of the base (figure s1.2).

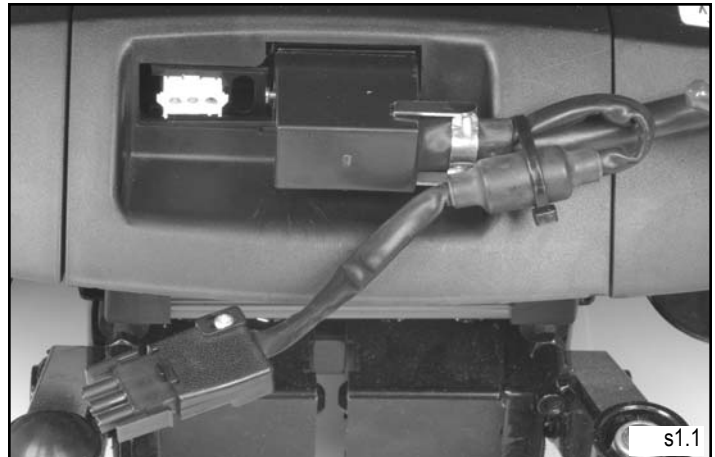

Reassembly

- a. Line up the rear seat frame with the rear seat posts, slide the seat back to the stops and let the seat frame rotate down in to the front seat post latching brackets.
- b. Make sure the latching levers are locked flat against the seat post brackets, and insert the locking pin.
- c. Plug the controller plugs into the plug receptacles at the rear of the chair.



Adjustment

Note: There is a setscrew in each “saddle” of the front seat post brackets that can adjust the free play of the seat frame in the bracket. Adjustment of this part is accomplished by using a 3 mm Hex wrench. After adjustment, ensure that the latching levers are fully seated and the locking pin can be installed see (figure s1.3).



Disassembly/Reassembly, and Adjustment (cont)

Step 2 - Cog Release

Disassembly

- Turn each of the two cog release handles counter-clockwise to unscrew them.

Note: For better access, pull the cog release handle to the free-wheel position (figure s2.1).

Reassembly

- Hold the cog release pivot joint, and thread the cog release handle back to the pivot joint.

Adjustment

Tighten the Jam nut to set the cog release handle to the correct orientation.

Note: It is recommended that the handles end up facing outward.



Step 3 - Seat Posts

Disassembly

- Remove the cap from the left side of the front shroud (Figure s3.1)
- Pull the spring loaded release pin to disengage the seat post. While holding the Spring Loaded Release Pin, slide the seat post to its maximum height position to expose the small quick release pin at bottom of shaft. (Figure s3.2)
- Remove the small quick release pin, pull the Spring Loaded Release Pin and remove the seat post.
- Pull out the three remaining quick release pins, and remove all other seat posts.

Reassembly

- perform the reverse of instructions above.



Disassembly/Reassembly, and Adjustment (cont)

Step 4 - Shroud

Disassembly

Note: Make sure the cog release pivot joints are in a position that matches the shroud cutout.

a. Use a #2 Phillips screw driver to remove the four mounting screws and slide out while lifting off the top shroud from the back of the chair.

(figure s4.1).

b. Use a #2 phillips screw driver to remove the six mounting screws on the inside of the shroud to remove the side shroud fairing (figure s4.2)

c. Lift the color side shrouds from the side shroud fairing.

Note: Color side shrouds are attached using a hook and loop fastener system.



Reassembly

a. Perform the reverse of instructions above.

Note: Remember short screws to rear and middle holes and long screws to front.



Disassembly/Reassembly, and Adjustment (cont)

Step 5 - Front Caster Cover

Disassembly

- a. Use a #2 Phillips screw driver to remove the two mounting screws on the side of the front caster cover. (figure s5.1).
- b. Use a #2 phillips screw driver to remove the two mounting screws and the caster cover mounting bracket (figure s5.2).
- c. Repeat steps a and b on the other side.

Reassembly

- a. Perform the reverse of instructions above.

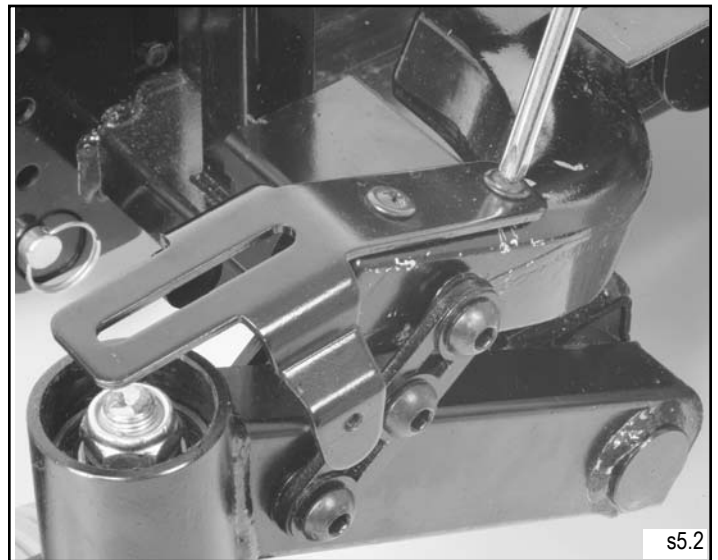
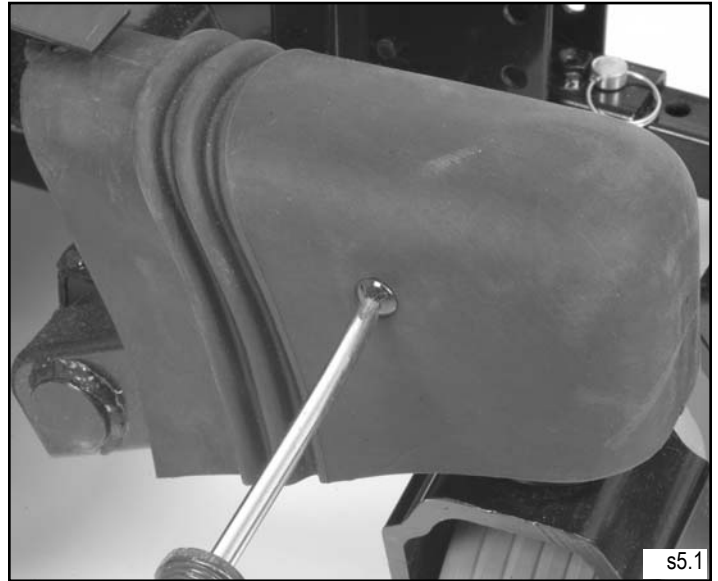

Disassembly/Reassembly, and Adjustment (cont)

Step 6 - Charger

Disassembly

- Peel the velcro strip apart, and remove the on-board charger (figure s6.1).
- Slide the female charger plug out of the beau plug bracket (figure s6.2)
- Depress the locking tabs and unplug the A/C plug and charger light indicator plug. (figure s6.1)

Reassembly

- First insert the velcro strip through the support ring before starting reassembly.
 - Perform the reverse of instructions above.
- Note: The charger bar code sticker side must face outward.

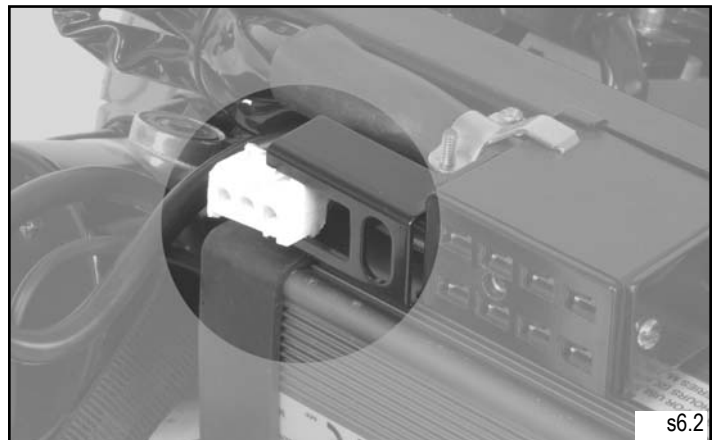

Step 7 - Battery

Disassembly

- Depress the locking tabs and unplug the battery connectors.
 - Grip the battery handle and pull the battery out of the base.
- Note - Pull out the front battery first, slide the second battery out of the base.(figure s7.1)

Reassembly

- Perform the reverse of instructions above.

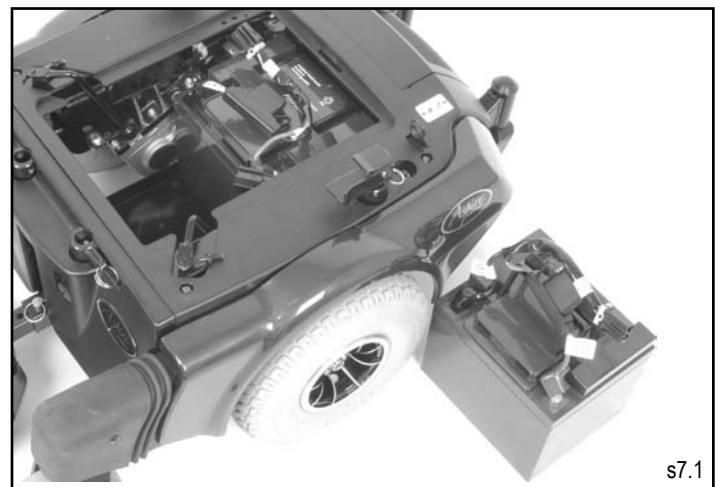

Disassembly/Reassembly, and Adjustment (cont)

Step 8 - Motor/Wheel

Disassembly

Note: For ease of disassembly, set the base frame on a block where all six wheels are at least 1 inch above the ground.

- Unwrap the wire looms from the motor and pull the motor connector out (figure s8.1).
- Depress the motor connector locking tab and unplug it (figure s8.1).
- Use a 5mm hex key to remove the six mounting screws (figure s8.2).
- Hold the motor-wheel assembly and tilt the cog release rod toward the center of the base to get around the motor mount, then pull the motor-wheel assembly out through the bottom of the frame.
- Straighten the lock washer tab of the drive wheel.
- Use a 17mm deep socket wrench to remove the drive wheel retention nut, then pull the drive wheel out from the motor shaft.

Note: If the drive wheel is difficult to remove, then remove the wheel plate screws (Phillips Head)

Reassembly

- Perform the reverse of instructions above.

Note: Torque specifications

- | | |
|-------------------------|--------------|
| * Motor mounting screws | 15-20 ft-lbs |
| * Wheel retention nut | 35-40 ft-lbs |
| * Wheel plate screw | 15-20 ft-lbs |

Adjustment

Note: There is a suspension bumper on the frame to limit the motor's movement (figure 8.3). It also changes the pre-load on the front caster.

- Use a 13mm open wrench to loosen or tighten the jam nut and make the proper adjustment (operator preference).
- Install wire tie on back inside corner of gear box.



Disassembly/Reassembly, and Adjustment (cont)

Step 9 - Motor Mounts

Disassembly

- Use a 5mm allen wrench and 13mm wrench to remove the mounting bolt connecting the linkage to the caster arm (figure s9.1).
- Use a 16mm wrench and 19mm wrench to remove the motor mount pivot bolt (figure s9.2).
- Slide the motor mount out from the base frame pivot bracket.

Reassembly

- Reverse above instructions.

Hint: If the mounting bolt is difficult to remove or install, then grasp the front trailing arm and the swing arm with one hand and squeeze together or remove the center bolt and the stopper tube.

Note: Torque specifications on the pivot bolt and the mounting bolt are 40 in-lbs.



Disassembly/Reassembly, and Adjustment (cont)

Step 10 - Front and Rear Caster Assembly

Disassembly

- a. Straighten the locking washer tabs on the front (figure s10.1) and/or rear (figure s10.2) caster assemblies.
- b. Use the 13mm wrench and 13mm socket wrench to remove the mounting bolts.
- c. Slide the caster assemblies out from the base frame tubes.

Reassembly

- a. Reverse above instructions.

Note: Torque specification on the mounting bolts is 13 ft-lbs.

Note: Bend locking tabs against bolt head flats.

Adjustment

Note: There is a suspension bumper on the rear caster assembly to limit rocking motion (figure s10.3).

- a. Use a 13mm open wrench to loosen or tighten the jam nut to make the proper adjustment (operator preference).

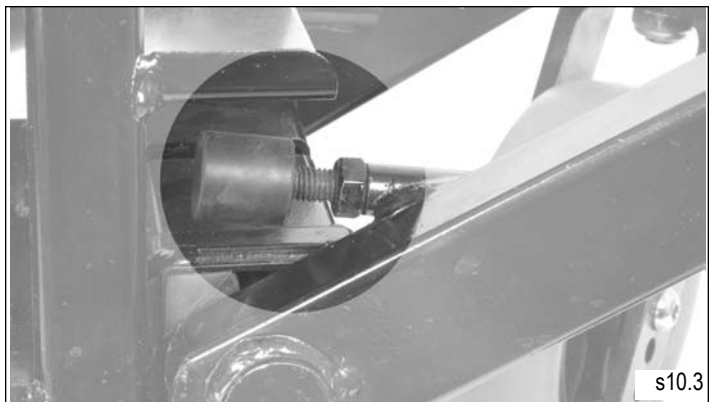
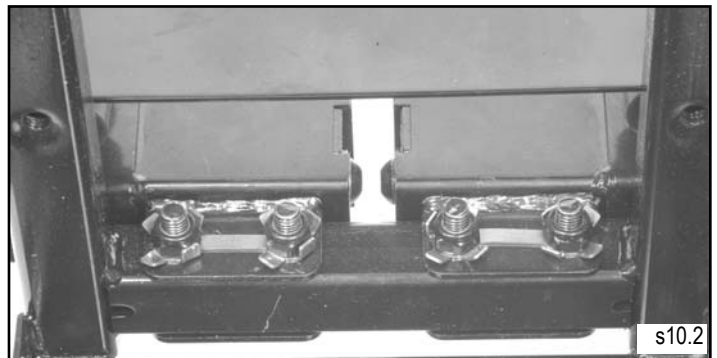
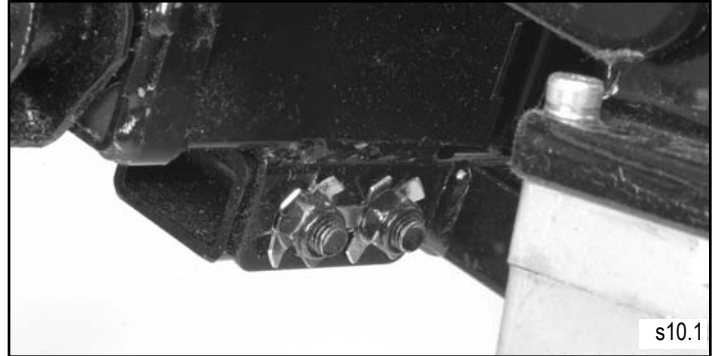

Disassembly/Reassembly, and Adjustment (cont)

Step 11 - Wire Harnesses

Disassembly

- a. Remove all the zip ties on the base frame.
- b. Unwrap all the wire loom ties securing the harness to the frame.
- c. For the main harness, remove the two screws that holding the female beau plug (figure s11.1).
- d. Remove the circuit breaker locking nut and push it through the bracket (figure s11.2), then remove the main wire harness.
- e. For the light and A/C harness, remove the front shroud and then remove the mounting screws on the A/C plug bracket.(figure s11.3).
- f. Push the light harness through the bracket.
- g. Pull the A/C harness through the bracket.

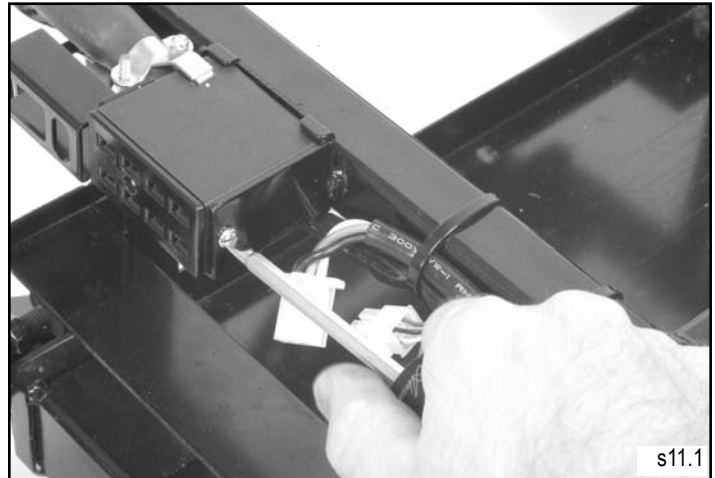

Reassembly

- a. Reverse above instructions.

Adjustment

Note: The circuit breaker can be removed without removing the main harness.

- a. Pull the quick disconnect terminal out from the bottom of the circuit breaker, then remove the circuit breaker locking nut.

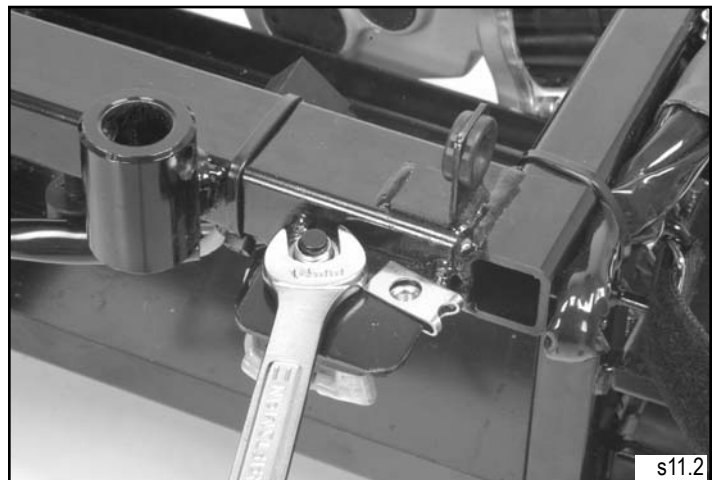

Free Manuals Download Website

<http://myh66.com>

<http://usermanuals.us>

<http://www.somanuals.com>

<http://www.4manuals.cc>

<http://www.manual-lib.com>

<http://www.404manual.com>

<http://www.luxmanual.com>

<http://aubethermostatmanual.com>

Golf course search by state

<http://golfingnear.com>

Email search by domain

<http://emailbydomain.com>

Auto manuals search

<http://auto.somanuals.com>

TV manuals search

<http://tv.somanuals.com>