

QUICKIE®

Quickie® P-220
P-222SE
Integrated C.G. Tilt

SUPPLIER:

THIS MANUAL MUST BE
GIVEN TO THE RIDER OF
THIS WHEELCHAIR.

RIDER:

BEFORE USING THIS
WHEELCHAIR READ THIS
ENTIRE MANUAL AND SAVE
FOR FUTURE REFERENCE.

*User
Instruction
Manual &
Warranty*



**QUICKIE P-220/P-222SE INTEGRATED C.G. TILT
USER INSTRUCTION MANUAL SUPPLEMENT**

NOTE: This supplement contains information on the operation and adjustments for the Integrated C.G.Tilt System of a Quickie P-220/P-222SE wheelchair ONLY. Please refer to the Quickie P-220/P-222SE User Instruction Manual for additional notices; EMI information; warnings; tips for attendants; set-up, adjustment and use information; operating guide; battery and maintenance information; wiring diagrams and warranty information regarding the Quickie P-220/P-222SE.

**Sunrise Medical
Customer Service Department
7477 East Dry Creek Parkway
Longmont, Colorado 80503
(303) 218-4500 or (800) 333-4000**

I. INTRODUCTION NOTE.....	2
II. TABLE OF CONTENTS.....	3
III. YOUR CHAIR AND ITS PARTS	4
IV. WARNINGS	6
A. Solid Seat Back	6
B. Driving.....	6
C. Tilting	6
D. Changes & Adjustments	6
V. SET UP, ADJUSTMENT & USE.....	7
A. Battery Removal.....	7
B. Solid Seat Back & Lateral Thoracic Supports	8
C. Headrest	8
D. Foam Back.....	9
E. Seat Tilt Adjustments & Drive Lock-out.....	9
F. Seat Depth	9
G. Backrest.....	10
H. Seat Height Adjustment.....	10
I. TM40 Single or Dual Switch Actuator Controller.....	10
J. Check-Out.....	11
VI. OPERATING GUIDE	12
A. Toggle Switch Activation	12
B. Single Switch Activation.....	12
C. Integral Joystick Activation	12
D. Remote Joystick Activation	12
E. Specialty Drive Controls.....	12
VII. MAINTENANCE & TROUBLESHOOTING TIPS	13
A. Maintenance	13
B. Troubleshooting Tips.....	13
VIII. WIRING DIAGRAMS	14
IX. SUNRISE LIMITED WARRANTY.....	16

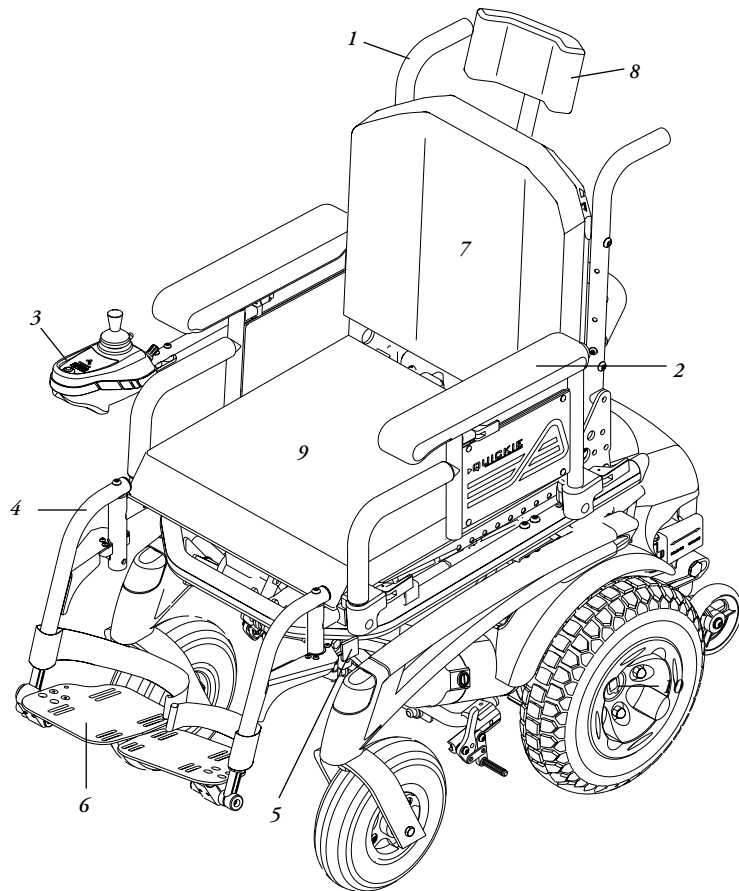

Quickie P-220/P-222SE Integrated C.G. Tilt

- | | |
|--|-----------------------------------|
| 1. Push Handle | 4. Swing-Away Footrest Hanger |
| 2. Dual Post, Height-Adjustable Armrest (optional) | 5. Footrest Release Lever |
| 3. Remote Joystick (optional- P-220; standard- P-222 SE) | 6. Angle-Adjustable Footplate |
| | 7. Backrest |
| | 8. Headrest |
| | 9. Seat Pan with optional cushion |

Joystick- P-220

- Standard - integral (right-hand or left-hand mount)
- Option - remote (left-hand or right-hand mount)
- Option - swing-away retractable joystick

Joystick- P-222SE

- Standard - remote (left-hand or right-hand mount)
- Option - swing-away retractable joystick

Batteries

- (2 batteries required to operate chair)
- Option - GP 24 deep cycle gel,
- Option - 22 NF deep cycle gel

Battery Charger

- Standard - off board (Lester)

Seat Frame Dimensions

- Seat Frame width: standard - 14"-20"
- Seat depth: 14"-20" adjustable
- Solid seat back
- Aluminum seat pan
- Optional cushions: Jay Cushions

CG Tilt

- 0° - 50°
- 3° - 53°

Backrest

- Standard - Non-folding: 15" - 20"
- Straight Backpost - standard

Footrest

- Standard - Swing-away with angle-adjustable footplates and heel loops.
- Option - elevating legrests and multiposition

Armrests

- Standard - dual post flip back
- Option - height-adjustable dual post or single post with desk or full length waterfall pads or standard armpads

Swing-Away Lateral Thoracic Supports

- Option - Curved
- Option - Straight

Headrest

- Standard - 8" x 5" or 7" x 4.5" headrest pad

All features may not be available with some chair setups or in conjunction with another chair feature. Please consult your supplier for more information. Your authorized supplier can also provide you with more information on accessories.

A. SOLID SEAT BACK

⚠ WARNING

Do not use the Solid Seat Back to push or lift the wheelchair. Improper use may cause the back to unexpectedly detach from the wheelchair.

B. DRIVING

⚠ WARNING

You should drive your chair with the tilt at the minimum angle.

C. TILTING

⚠ WARNING

To prevent damage and personal injury, avoid tilting near objects such as walls, tables or chairs.

To avoid injury, ensure other people, especially children, are clear of the system.

If using a swing-away abductor, be sure not to tilt with the abductor swung away. Otherwise, the abductor may collide with the tilt actuator when returning to the untilted position.

D. CHANGES & ADJUSTMENTS

⚠ WARNING

Never use non-Quickie parts or make changes to your chair unless authorized by Sunrise. (Doing so will void the warranty and may create a safety hazard.)

1. If you modify or adjust this chair it may increase the risk of fall or tip-over.
2. Modifications unauthorized by Sunrise constitutes remanufacturing of the wheelchair. This voids the warranty. The rider then assumes all future liability for the wheelchair.

TOOLS YOU WILL NEED

1. Basic Tool Kit:

To set up, adjust and maintain your chair you will need the following tools:

- 5/32" Allen wrench
- 3/16" Allen wrench
- 5/16" Allen wrench
- 9/16" box and open-end wrench
- 1/2" box and open-end wrench
- Phillips screwdriver #1
- Standard slot screwdriver

NOTE— Setting the wheelchair on a flat surface, such as a table or a workbench, helps make these procedures easier.

A. BATTERY REMOVAL

To remove the batteries for transporting or servicing:

Remove Batteries

- a. Remove seat and main frame from power drive unit using quick-release levers (C).
- b. Lift battery compartment lid (E) off of power drive unit.
- c. Prevent the power drive unit from tipping forward by placing a solid object underneath the front of the power drive unit.
- d. Disconnect battery leads from power harness.
- e. Lift rear most battery out using the battery straps (F).
- f. Pull the front battery rearward, disconnect it, and remove it using the battery straps.

⚠ WARNING

Batteries may weigh up to 55 lbs. (25 kg). Care must be taken to avoid injury when lifting.

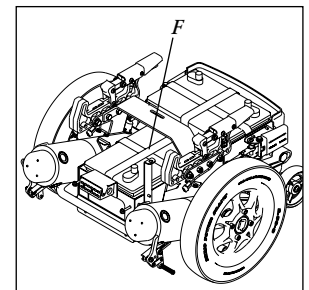
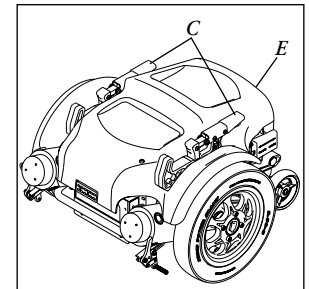

B. SOLID SEAT BACK & LATERAL THORACIC SUPPORTS

1. To adjust the height of the lateral support mount, loosen the adjustment screw until the receiver slides freely on the back posts. Tighten the adjustment screw when the proper height is determined.
2. Assess and fit the lateral thoracic supports. Assess client for proper positioning of the lateral thoracic supports. Each support is independent and may be adjusted for your client's clinical need.

⚠ WARNING

A minimum of 1" (2.5 cm) of clearance should exist between the top of the lateral support and the user's arm pit.

- a) To adjust the height, angle or width of the lateral thoracic support pads, loosen the top bolts and slide to correct width. Tighten bolt to bolt plate. If more adjustment is necessary, loosen the internally mounted bolts, and slide in the track to the desired height and width. The angle is obtained by tilting the bracket as needed. Tighten the bolts.
- b) To adjust the depth of the lateral thoracic pads, turn the middle bracket so that the slots are on side. Adjust to desired depth. Retighten the bolts.

C. HEADREST

1. Mounting a headrest.
The Solid Seat Back has a headrest plate mounted to it. Care should be taken to use the proper screw length when mounting.
2. To position the headrest use the double clamp and the collar clamp (B,C,D) to obtain the proper height and distance. For clamp B use a 3/32 Allen set screw (A) and a 3/16 Allen cap screw. Clamp B positions the headrest forward and aft. However, due to the vertical movement of this adjustment, collar clamp D will have to be moved in conjunction.
3. Retighten both the 3/16 Allen and the set screws (A) with a 3/32 Allen wrench.

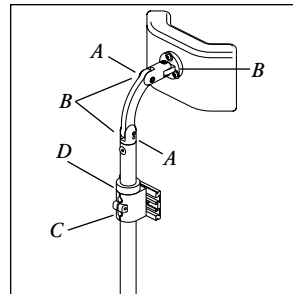
**D. FOAM BACK**

Secure the foam and cover to the shell.

To secure the back foam and cover on the Solid Seat Back, slide the top edge of the cover over the top lip of the shell. Press the back in place against the shell.

E. SEAT TILT ADJUSTMENTS & DRIVE LOCK-OUT**1. Maximum Tilt Angle**

Maximum tilt angle can be adjusted to a limit of 50°.

- a) Remove access cover on the actuator housing.
- b) Position the most forward switch such that the actuator shuts down when the desired maximum tilt is achieved.
- c) Tighten the switch to the track, and replace the cover on the actuator housing.

2. Drive Lock-out Angle

The drive lock-out angle is adjustable.

- a) Tilt the seat back at least 15°-20°.
- b) Remove the access cover on the actuator.
- c) Adjust the middle limit switch until the desired lock-out position is achieved.
- d) Replace the access cover on the actuator housing.

NOTE- The drive lock-out should be set such that the chair cannot be driven with the seat tilted to an angle of greater than 15°.

F. SEAT DEPTH

The seat depth can be adjusted in one inch increments.

1. Seat Frame Depth Adjustment

- a) To adjust, remove the two bolts (C & D p. 10) from each side of the backrest pivot plate.
- b) Reposition the backrest to the desired position.
Note: Substitute Bolt (D) with rear back rest pivot plate bolt (C) for 18" seat depth.
- c) Replace and retighten bolts on each side of the backrest pivot plate.

G. BACKREST

A backrest angle adjustment is standard.

1. Adjustment on Seat Frame

- Remove the front securing bolt (C) on the side of the backrest hinge plate.
- Loosen the lower rear bolt (D)
- Set at desired angle. There are four holes (in 4° increments) to choose from.
- Reinstall the front bolt and tighten both bolts securely.

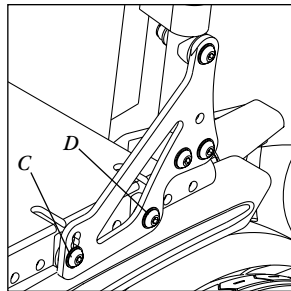

H. SEAT HEIGHT ADJUSTMENT

The front seat height can be adjusted from 19.75" to 21.75" in 1" increments. Adjust front seat frame posts (X) up or down to desired height.

The rear seat height can be adjusted to change the seat angle relative to the front seat height. The components to change rear seat height are included with each P-220/P-222 SE. Installing 2 each of part number 540176 will elevate the rear 1" from standard.

Installing 2 each of part number 540177 will elevate the rear 2". It is recommended that a qualified dealer provide this service if desired.

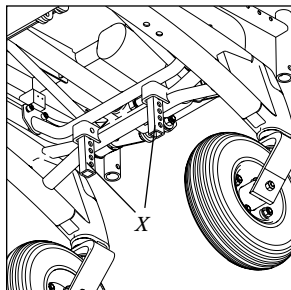

I. TM40 SINGLE OR DUAL SWITCH ACTUATOR CONTROLLER

(Refer to diagram on next page)

The TM40 actuator controller can be used to activate the tilt mechanism with either single or dual switch controls.

- Plug limit switch harness assembly (A) into TM40 limit switch jack (B).
- Plug single switch into TM40 single switch jack (D) OR plug dual switch (E) into TM40 dual switch jack (F).
- Plug TM40 into the QTRONIX Power Module (G).
- Use mating plugs (H) to connect the TM40 to the tilt actuator.

J. CHECK-OUT

Once the tilt assembly is adjusted, it should actuate smoothly and easily. All accessories should also perform smoothly.

- Verify seat can achieve full tilt and will return to neutral.
- Verify the motor cuts out once the neutral position is reached.
- Verify no debris is interfering with the glide bearings.
- Verify all hardware is securely tightened.
- Verify that the drive lock-out switch is positioned to prevent driving if the system is tilted to an angle of greater than 15°.

⚠ WARNING

If the actuator stop switches are not properly adjusted, the actuator will current limit or "stall" at the end of the stroke. Repeated "stall" conditions will shorten the life of the actuator.

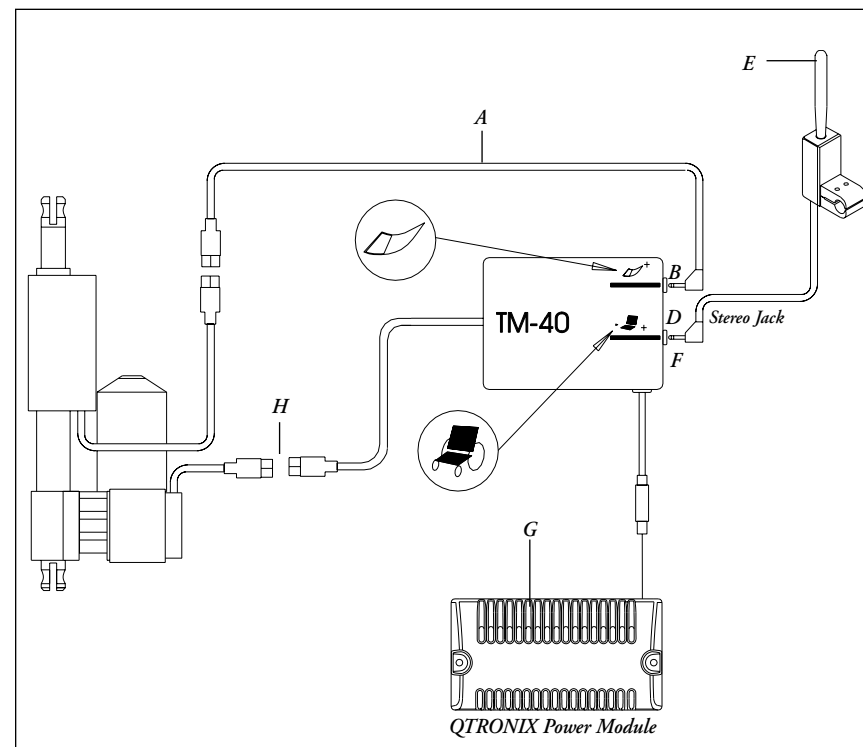

TO OPERATE THE C.G. TILT**A. TOGGLE SWITCH ACTIVATION**

- To operate, push the toggle switch (A) forward (to tilt back) or pull toggle backward (to return to neutral) until tilted into the desired position.
- The toggle switch will return to neutral when released and the seating system will stop moving.

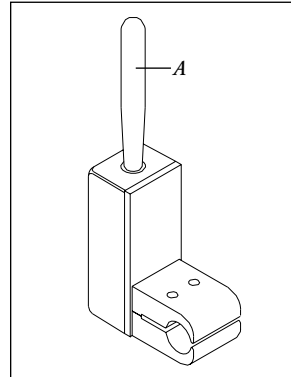
**B. SINGLE SWITCH ACTIVATION**

- Depress and hold single switch to tilt back into the desired position.
- Depress and hold single switch to return to neutral until tilted into the desired position.

C. INTEGRAL JOYSTICK ACTIVATION (OPTIONAL)

From the "off" position:

- Push the on/off button (A) once to turn the chair on.
- Push either tilt button (B or C) to activate tilt mode.
- Push forward on joystick (D) to tilt back.
- Pull backward on joystick (D) to tilt forward.
- Push either tilt button (B or C) to deactivate and resume drive mode.

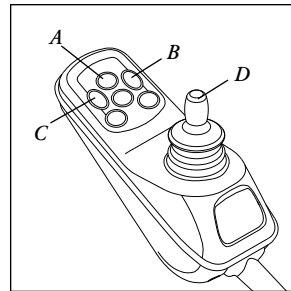
**D. REMOTE JOYSTICK ACTIVATION (OPTIONAL)**

From the "off" position

- Push the on/off mode select toggle switch (A) down once to turn the chair "on".
- Push the on/off mode select toggle switch (A) up twice to move index to tilt mode (noted by two (2) actuator lights (B)).
- Push the joystick (C) forward to tilt backward or backward to tilt forward.
- Push the on/off mode select toggle switch (A) up once to return to drive mode.

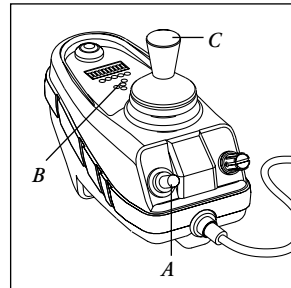
**E. SPECIALTY DRIVE CONTROLS (OPTIONAL)**

Please refer to your QTRONIX USCM User Instruction Manual.

CAUTION– The power base drive lock-out feature will activate and the chair cannot be driven if the seating system is tilted more than 20°.

A. MAINTENANCE

You should check the items on this chart at the indicated intervals. If any of the items are loose, worn, bent or distorted, immediately have them checked and/or repaired by your authorized Sunrise supplier. Frequent maintenance and servicing will improve performance and extend wheelchair life.

NOTE– Check weekly, and use a clean, dry cloth or compressed air as needed to keep glide bearings free of debris.

CHECK...	Daily	Weekly	Monthly	Quarterly	Annually
Charge Batteries	✓				
Glide bearings free of debris			✓		
Check tires for proper inflation level			✓		
Check batteries for proper electrolyte level (wet cell only)			✓		
Check plugs and connectors for proper connections				✓	
Check all moving parts for wear					✓
Inspect all nuts, bolts and fasteners for looseness or wear					✓
Inspect upholstery for wear					✓
Remove and inspect motor brushes					✓
Servicing by authorized Supplier					✓
Check front mount bolts for looseness					✓
Check actuator limit switch position					✓
Check front mount for excessive wear					✓

B. TROUBLESHOOTING TIPS

If you should notice your C.G. Tilt system binding up, not running in a smooth fashion, or emitting an unusual noise during use, a foreign matter may have come into contact with the glide bearings. If this occurs, use a clean, dry cloth or compressed air to clear or, if needed, please see your authorized Sunrise supplier.

If your tilt system will not function, check to ensure the tilt lock-out sensor is seated properly in its mount. The wires should lead out of the sensor toward the front of the chair.

TM40 ACTUATOR CONTROLLER (Independent switch control and Integral Joystick)

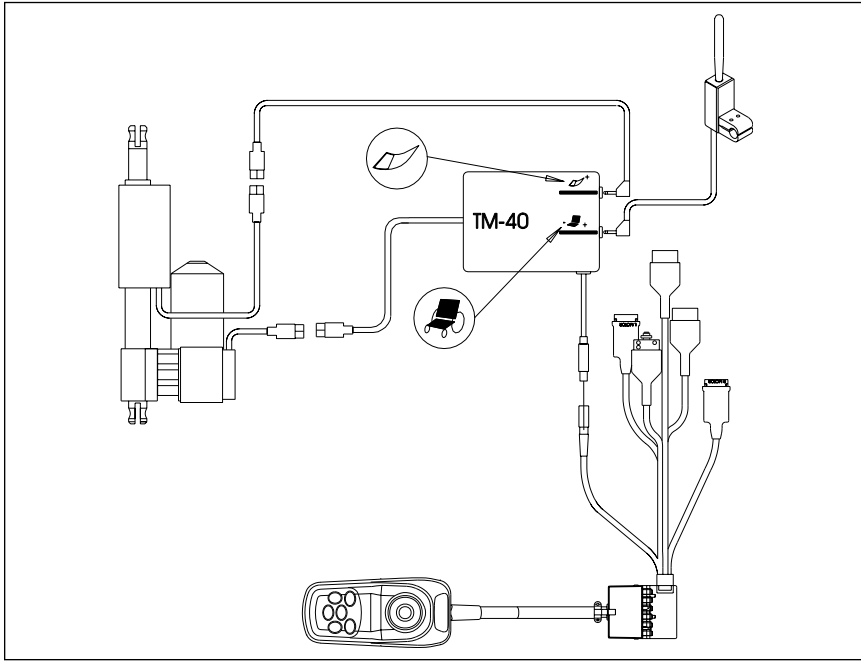

TM40 ACTUATOR CONTROLLER (Independent switch control and Remote Joystick)

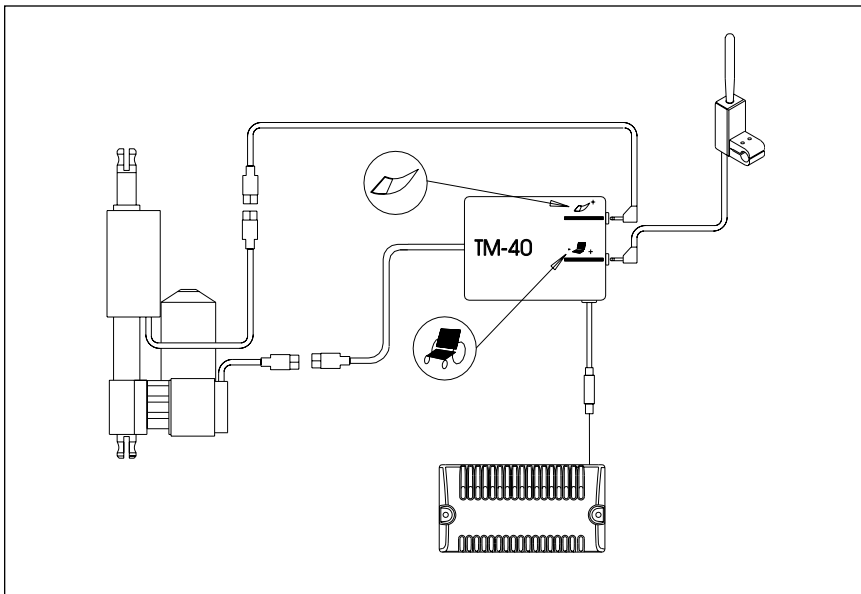

ALM ACTUATOR CONTROLLER (Through drive control- Integral Joystick)

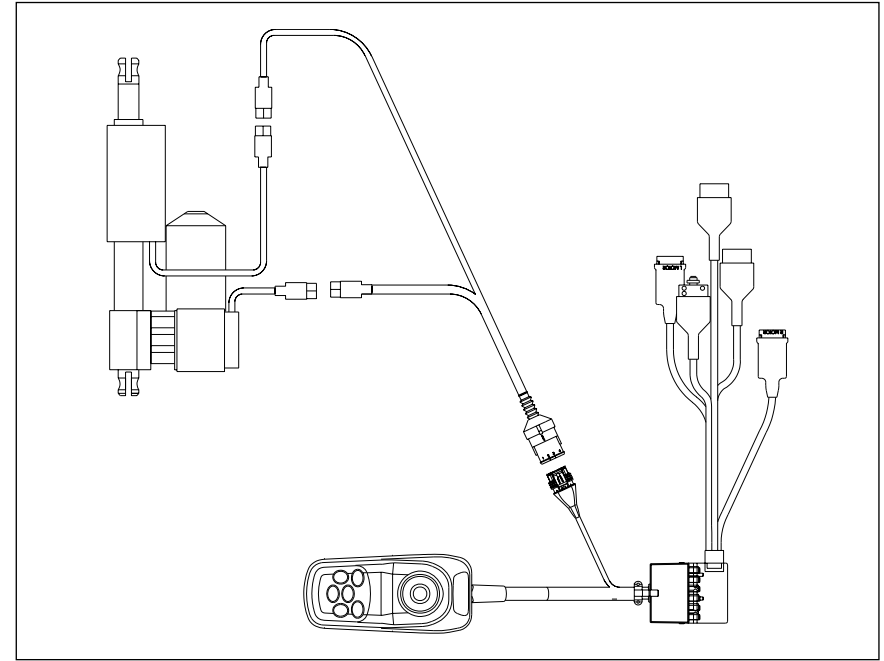

ALM ACTUATOR CONTROLLER (Through drive control- Remote Joystick)

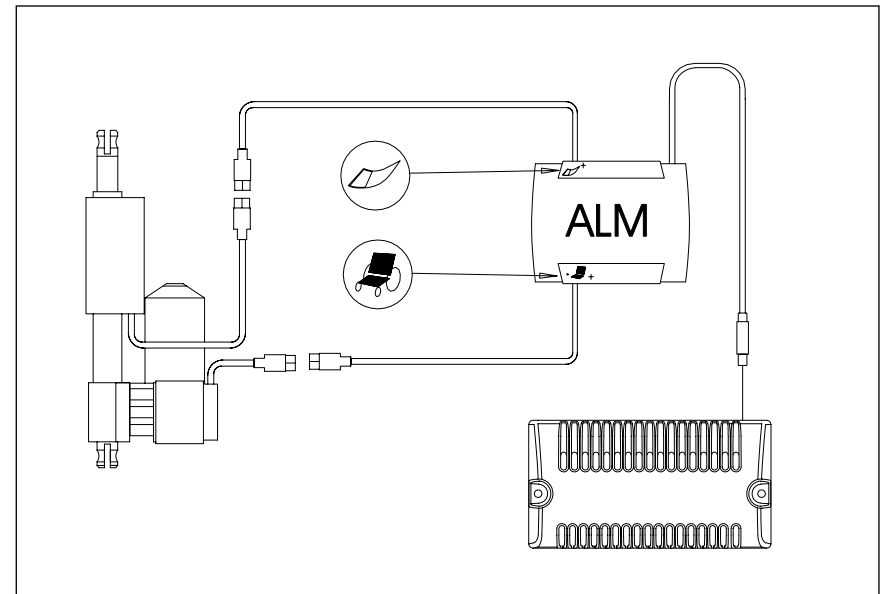

FOR THREE (3) YEARS:

We warrant the C.G. power tilt seating system seat frame, sub-base frame, actuator and structural components of this wheelchair against defects in materials and workmanship for three (3) years from the date of first consumer purchase.

FOR TWO (2) YEARS:

We warrant the ALM (Actuator Lights Module) actuator controller for two (2) years from the date of first consumer purchase.

FOR ONE (1) YEAR:

We warrant other electronic components such as the single switch actuator controller for one (1) year from the date of first consumer purchase.

ADDITIONAL WARRANTY:

We warrant all other original components (such as upholstery, plastic, rubber parts and painted surfaces) for three (3) months from the date of first consumer purchase.



Sunrise Medical

7477 East Dry Creek Parkway • Longmont, Colorado • 80503 USA

(800) 333-4000

In Canada (800) 263-3390

© 2002, Sunrise Medical 5.02

930478 Rev A

Free Manuals Download Website

<http://myh66.com>

<http://usermanuals.us>

<http://www.somanuals.com>

<http://www.4manuals.cc>

<http://www.manual-lib.com>

<http://www.404manual.com>

<http://www.luxmanual.com>

<http://aubethermostatmanual.com>

Golf course search by state

<http://golfingnear.com>

Email search by domain

<http://emailbydomain.com>

Auto manuals search

<http://auto.somanuals.com>

TV manuals search

<http://tv.somanuals.com>