



INSTALLATION AND OPERATING INSTRUCTIONS

STANDARD SERIES



Unvented See-Through Gas Log Room Heaters
P/N 903588 REV. G 12/2007

MODELS

VFST-27VSN-2

VFST-27VSP-2

INSTALLER: Leave this manual with the appliance.
CONSUMER: Retain this manual for future reference.

FOR USE ONLY WITH DECORATIVE TYPE UNVENTED ROOM HEATERS.

DO NOT BUILD A WOOD FIRE.

NATIONAL FIREPLACE INSTITUTE

CERTIFIED
www.nficertified.org

We suggest that our gas hearth products be installed and serviced by professionals who are certified in the U.S. by the National Fireplace Institute® (NFI) as NFI Gas Specialists.

Tested & Listed By

O-TL
OMNI-Test Laboratories, Inc.
 Beaverton Oregon USA

WARNING: IMPROPER INSTALLATION, ADJUSTMENT, ALTERATION, SERVICE OR MAINTENANCE CAN CAUSE INJURY OR PROPERTY DAMAGE. REFER TO THIS MANUAL. FOR ASSISTANCE OR ADDITIONAL INFORMATION CONSULT A QUALIFIED INSTALLER, SERVICE AGENCY OR THE GAS SUPPLIER.

WARNING: IF THE INFORMATION IN THIS MANUAL IS NOT FOLLOWED EXACTLY, A FIRE OR EXPLOSION MAY RESULT CAUSING PROPERTY DAMAGE, PERSONAL INJURY OR LOSS OF LIFE.

WARNING: DO NOT BURN WOOD OR OTHER MATERIAL IN THESE APPLIANCES.

CAREFULLY REVIEW THE INSTRUCTIONS SUPPLIED WITH THE DECORATIVE TYPE UNVENTED ROOM HEATER FOR THE MINIMUM FIREPLACE SIZE REQUIREMENT.

FOR YOUR SAFETY: Do not store or use gasoline or other flammable vapors or liquids in the vicinity of this or any other appliance.

DO NOT INSTALL THE APPLIANCE IN THIS FIREBOX, UNLESS THIS FIREBOX MEETS THE MINIMUM DIMENSIONS REQUIRED FOR THE INSTALLATIONS.

FOR YOUR SAFETY: What to do if you smell gas:

- DO NOT light any appliance.
- DO NOT touch any electrical switches.
- DO NOT use any phone in your building.
- Immediately call your gas supplier from a neighbor's phone.

This is an unvented gas-fired heater. It uses air (oxygen) from the room in which it is installed. Provisions for adequate combustion and ventilation air must be provided. Refer to Combustion and Ventilation Air Section, Page 3.

Follow your gas suppliers instructions.

- If your gas supplier cannot be reached, call the fire department.

Due to high temperatures, the appliance should be located out of traffic and away from furniture or draperies.

Do not place clothing or other materials on or near this appliance.

Installation and service must be performed by a qualified installer, service agency or the gas supplier.

IMPORTANT: READ THESE INSTALLATION INSTRUCTIONS CAREFULLY BEFORE INSTALLING OR TRYING TO OPERATE THIS HEATER.

TABLE OF CONTENTS

General Information	page 2
Inventory	page 2
Tools Required	page 2
Important Safety Information	page 2
Codes	page 3
Combustion and Ventilation Air	page 3
Preinstallation	page 4
Clearances	page 4
Installation	page 6
Gas Pressure Check	page 6
Assembling the Logs	page 7
Flame Appearance	page 7
Cleaning and Servicing	page 8
Replacement Parts	page 8
Troubleshooting Guide	page 9
Operating Instructions	page 10
Replacement Parts List	page 12

GENERAL INFORMATION

These See-Through Unvented Gas Log Room Heaters incorporate unitized ceramic fiber logs which glow realistically when the heater is operating.

These log heaters are either thermostatic (T-stat) or manually controlled. The control knob is set to the desired position, which maintains a continuous gas burning rate.

A spark ignition system (piezo) allows the gas pilot to be lit without the use of matches or batteries and permits operation of the heater during a power outage.

These heaters are fitted with a specially designed pilot utilizing an oxygen depletion sensor (ODS) which responds to the amount of oxygen available in the room and shuts the heater off before the oxygen level drops below 18%.

The pilot can be relit only when fresh air is available. Refer to the Combustion and Ventilation Air section.

WARNING: THIS APPLIANCE IS FOR INSTALLATION IN A SOLID FUEL BURNING FIREPLACE WITH A WORKING FLUE OR AN APPROVED VENTLESS FIREBOX ENCLOSURE ONLY.

Minimum Fireplace (Firebox) Size

Height	Depth	Width
16"	18"	28" Front

Table 1

Do not install these See-Through Unvented Gas Log Room Heaters in a bedroom or a bathroom as all units exceed maximum allowable BTU/hr input of 10,000.

Check the inventory list to be sure that you have all the necessary parts in usable condition. Also check for concealed damage.

WARNING: FAILURE TO INSTALL THESE LOGS EXACTLY AS DETAILED IN THIS INSTRUCTION MANUAL MAY RESULT IN SOOTING AND MAY RESULT IN VOIDING PRODUCT WARRANTIES.

Inventory

- Unvented gas log room heater
- Bag of decorative volcanic rock
- Ceramic fiber logs
- Installation and Operating Instructions

Tools and Supplies Normally Required

- External regulator (Propane models only)
- Manual shut-off valve
- Sediment trap
- Piping complying with local codes
- Pipe compound
- Pipe wrench
- Tee joint
- Screwdriver

IMPORTANT SAFETY INFORMATION

INSTALLER: PLEASE LEAVE THESE INSTRUCTIONS WITH THE OWNER.

OWNER: PLEASE RETAIN THESE INSTRUCTIONS FOR FUTURE REFERENCE.

WARNING: ANY CHANGE TO THIS ROOM HEATER OR ITS CONTROLS CAN BE DANGEROUS. IMPROPER INSTALLATION OR USE OF THIS HEATER CAN CAUSE SERIOUS INJURY OR DEATH FROM FIRE, BURNS, EXPLOSION OR CARBON MONOXIDE POISONING.

Carbon Monoxide Poisoning: Early signs of carbon monoxide poisoning are similar to the flu with headaches, dizziness and/or nausea. If you have these signs, obtain fresh air immediately. Have the Unvented Gas Heater serviced as it may not be operating correctly.

- Due to high temperatures, the heater should be located out of traffic and away from furniture and draperies.
- Children and adults should be alerted to the hazard of high surface temperature and should stay away to avoid burns or clothing ignition.
- Young children should be carefully supervised when they are in the same room with the heater.
- Do not place clothing or other flammable material on or near the heater.
- Any safety screen or guard removed for servicing the heater must be replaced prior to operating the heater.
- Installation and repair should be done by a qualified service person. The heater should be inspected before use and at least annually by a professional service person. More frequent cleaning may be required due to excessive lint from carpeting, bedding material, etc. It is important that control compartments, burners and circulating air passageways of the heater be kept clean.

UNVENTED SEE-THROUGH GAS LOG ROOM HEATER TECHNICAL CHART

Model No.	BTU/HR High	Gas Type	Ignition	Regulator Pres. Setting	Gas Inlet Pressure	Valve Operation
VFST-27VSN	34,000	Natural	Piezo	5" w.c.	Max. 10.5" w.c. Min. 6" w.c.	Manual (Millivolt)
VFST-27VSP	34,000	Propane/LPG	Piezo	10" w.c.	Max. 13" w.c. Min. 11" w.c.	Manual (Millivolt)

Note: Test gage connections are provided on the front of the gas control valve (identified A for the manifold side and E for inlet pressure).

- Allow the heater to cool before servicing. Always shut off the gas to the heater while performing service work.

- Do not install the heater in a bedroom or bathroom.

- The installation must conform with local codes or, in the absence of local codes with the National Fuel Gas Code, ANSI Z223.1.

- The heater and its individual shut-off valve must be disconnected from the gas supply piping system while performing any tests of the gas supply piping system at pressures in excess of 1/2 psig.

- The heater must be isolated from the gas supply piping system by closing its individual manual shut-off valve during any pressure testing of the gas supply piping system at test pressures equal to or less than 1/2 psig.

- Keep heater area clear and free from combustible materials, gasoline and other flammable vapors and liquids.

- Do not use this heater if any part has been under water. Immediately call a qualified service technician to inspect the room heater and to replace any part of the control system and any gas control which has been under water.

- Input ratings are shown in BTU per hour and are for elevations up to 4,800 feet. Do not install this heater at an elevation above 4,800 feet if the gas supply has not been derated for that elevation. Consult your local gas supplier. (For operation at elevations above 4,800 feet, equipment ratings shall be reduced at the rate of 4 percent for each 1,000 feet above sea level before selecting appropriately sized equipment.)

- Ensure that the heater is clean when operating. Excessive dust accumulation on the burner and/or logs will increase the amount of carbon monoxide formation and could lead to carbon monoxide poisoning and/or death.

- DO NOT install this heater into a single (front) opening fireplace. This heater is designed to be used in see-through (multi-open) fireplaces only.

CODES

Adhere to all local codes or in their absence the latest edition of The National Fuel Gas Code ANSI Z223.1 or NFPA54 which can be obtained from The American National Standards Institute, Inc. (1430 Broadway, New York, NY, 10018) or National Fire Protection Association, Inc. (Batterymarch Park, Quincy, MA, 02269).

Massachusetts And New York Requirements

These appliances are approved for installation in the following USA locations listed in the following:

Massachusetts:

These fireplaces are approved for installation in the US state of Massachusetts if the following additional requirements are met-

- Installation and repair must be done by a plumber or gas fitter licensed in the Commonwealth of Massachusetts.

- The flexible gas line connector used shall not exceed 36 inches (92 centimeters) in length.

- The individual manual shut-off must be a T-handle type valve.

- Vent-Free appliances may NOT be installed in bedrooms or bathrooms.

- A working smoke detector must be installed in the area where vent-free appliances are installed.

Seller of unvented propane or natural gas-fired supplemental room heaters shall provide to each purchaser a copy of 527 CMR 30 upon sale of the unit.

New York:

These fireplaces are approved for installation in the US state of New York, but not in New York city.

State or local codes may only allow operation of this appliance (manual version only) in a vented configuration. Check your state or local codes. Superior Unvented Gas Log Room Heaters are certified by OMNI to ANSI Z21.11.2 standard. These gas log room heaters may be used as a space heat source for a room in conjunction with an approved unvented firebox. Additionally, manually controlled units are design certified by OMNI to ANSI 21.60 as a vented gas log set.

COMBUSTION AND VENTILATION AIR

These heaters shall not be installed in a confined space. The heater may be located in unusually tight construction provided the space is unconfined, or if confined, is provided with two permanent openings communicating directly with an additional room(s) of sufficient volume so that the combined volume of all connected spaces meets the criteria for an unconfined space, (National Fuel Gas Code ANSI Z223.1 (latest edition), Section 5.3). Generally 50 ft³ per 1,000 BTU input of all operating appliances in the space.

The National Fuel Gas Code defines a confined space as a space whose volume is less than 50 ft³ per 1,000 BTU/Hr (4.8 m³ per kw) of the aggregate input rating of all appliances installed in that space and an unconfined space as a space whose volume is not less than 50 ft³ per 1,000 BTU/Hr (4.8 m³ per kw) of the aggregate input rating of all appliances installed in that space. Rooms communicating directly with the space in which the appliances are installed, through openings not furnished with doors, are considered a part of the unconfined space.

Unusually tight construction is defined as construction where:

a. wall and ceilings exposed to the outside atmosphere have a continuous water vapor retarder with a rating or one perm or less with openings gasketed or sealed, and

b. weather stripping has been added on operable windows and doors, and

c. caulking or sealants are applied to areas such as joints around window and door frames, between sole plates and floors, between wall-ceiling joints, between wall panels, at penetrations for plumbing, electrical, and gas lines, and at other openings.

Use the following equations to determine if you have a confined or unconfined space.

1. Determine the volume of space — ft³.

Length x Width x Height = _____ ft³
(Include adjoining rooms with doorless passageways or ventilation grills between rooms.)

Example: 24' (L) x 16' (W) x 8' (H) = 3072 ft³

2. Divide the volume of space by 50 ft³ to determine the maximum BTU/Hr the space can support.

_____ (volume of space – ft³) / 50 ft³ =
(Maximum BTU/Hr the space can support)

Example: 3072 ft³ / 50 ft³ = 61.44
or 61,440 BTU/Hr the space can support.

3. Add the BTU/Hr of all the fuel burning appliances in the space.

Vent-Free heater	_____	BTU/Hr
Gas appliance #1*	_____	BTU/Hr
Gas appliance #2	+ _____	BTU/Hr
Total = _____		BTU/Hr

Example:

VFST heater	34,000	BTU/Hr
Gas appliance #1 (water heater)	35,000	BTU/Hr
Total =		69,000 BTU/Hr

* Do not include direct-vent gas appliances. Direct-vent is sealed combustion and draws combustion air from the outdoors.

4. Compare the maximum BTU/Hr the space can support with the actual amount of BTU/Hr used.

_____ BTU/Hr
(max. the space can support)
_____ BTU/Hr
(actual amount of BTU/Hr used)

Example:

61,440	BTU/Hr
(max. the space can support)	
69,000	BTU/Hr
(actual amount of BTU/Hr used)	

The space in the previous example is a confined space because the actual BTU/Hr used is more than the maximum BTU/Hr the space can support. You must provide additional fresh air.

Your options are:

- a. Rework equations adding the space of adjoining room(s). If the extra volume provides an unconfined space, then remove door or add ventilation grills between rooms. Refer to National Fuel Gas Code, ANSI Z223.1 1992, Section 5.3.
- b. Vent room directly to the outdoors. Refer to National Fuel Gas Code, ANSI Z223.1 1992, Section 5.3.

If the actual BTU/Hr used is less than the maximum BTU/Hr the space can support, then the space is an unconfined space. You will need no additional fresh air ventilation for an unconfined space.

WARNING: IF THE AREA IN WHICH THE HEATER MAY BE OPERATED IS SMALLER THAN THAT DEFINED AS AN UNCONFINED SPACE, PROVIDE ADEQUATE COMBUSTION AND VENTILATION AIR BY ONE OF THE METHODS DESCRIBED IN THE NATIONAL FUEL GAS CODE, ANSI Z223.1 1992, SECTION 5.3 OR APPLICABLE LOCAL CODES.

PREINSTALLATION

WARNING: BEFORE INSTALLING IN A SOLID FUEL BURNING FIREPLACE, THE CHIMNEY FLUE AND FIREBOX MUST BE CLEANED OF SOOT, CREOSOTE, ASHES AND LOOSE PAINT BY A QUALIFIED CHIMNEY CLEANER.

Note: Illustrations shown in this manual reflect "typical" installations with nominal dimensions and are for reference only. Actual installations may vary due to individual design preferences. However, always maintain minimum clearances to combustible materials and do not violate any specific installation requirements. Refer to Figures 1 through 7 for clearances.

Note: The following steps represent the normal sequence of installation. Each installation is unique, however, and might require a different sequence.

When local codes require the damper to be fixed open, a damper stop must be installed to prevent full closure of the fireplace damper and provide a minimum 29 square inch flue opening at all times. Refer to accessories for damper clamp.

If damper clamp is not available, the damper may be fixed open in the following manner. Drill a hole in the end of the damper. Screw in a bolt of sufficient size and adjust to provide the minimum 29 square inches of flue opening.

CAUTION: HEATERS CREATE WARM AIR CURRENTS. THESE CURRENTS MOVE HEAT TO WALL SURFACES NEXT TO HEATER. INSTALLING HEATER NEXT TO VINYL OR CLOTH WALL COVERINGS OR OPERATING HEATER WHERE IMPURITIES IN THE AIR (SUCH AS TOBACCO SMOKE) EXISTS, MAY DISCOLOR WALLS.

Step 1. Turn off gas supply to the fireplace or firebox.

Step 2. Install and secure heater in fireplace or firebox.

Step 3. Connect gas line.

Step 4. Assemble logs and test flame.

Step 5. Sprinkle volcanic rock over base plate in front of and below the main burner.

Check Gas Type

This heater can only be connected to the gas type specified on the heater rating plate. **This heater can not be modified in the field for a different gas type.** If the gas supply differs, **DO NOT INSTALL** the heater. Contact your dealer to obtain the correct heater.

CLEARANCES

WARNING: DO NOT INSTALL THIS GAS HEATER:

- IN SLEEPING QUARTERS, BATHROOMS, A MOBILE HOME, OR A RECREATIONAL VEHICLE.
- WHERE CURTAINS, FURNITURE, CLOTHING OR OTHER FLAMMABLE OBJECTS ARE LESS THAN 42" FROM THE FRONT OF THE GAS HEATER.
- IN HIGH TRAFFIC AREAS.
- IN WINDY OR DRAFTY AREAS.

Ensure the minimum clearances shown in Figures 1 through 7 are maintained. Left and right clearances are determined when facing the front of the heater.

Follow these instructions carefully to ensure safe installation. Failure to follow these requirements may create a fire hazard.

Step 1. Sidewall Clearances: The sides of the fireplace opening must be at least 16" from any combustible side wall (Figure 1).

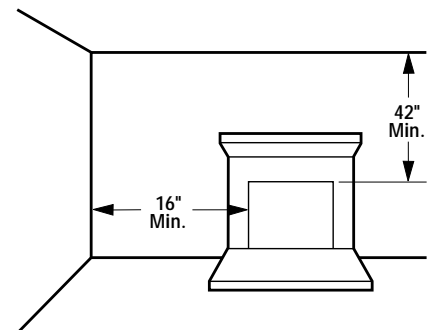

Figure 1

Step 2. Ceiling Clearance: The ceiling must be at least 42" from the top of the heater opening (Figure 1).

NOTE: DIAGRAMS & ILLUSTRATION NOT TO SCALE.

Noncombustible Material Requirements with No Mantel Installed

(A) Noncombustible Material Measurement	Requirements for Safe Installation
12" or more	Adjustable canopy not required.
8" minimum to 12"	Install adjustable canopy, P/N 053751 or P/N 053752 (Figure 3).
Less than 8"	Extend noncombustible material to at least 8" and install adjustable canopy (Figure 3). or Extend noncombustible material to a height of at least 12".

Table 2

Noncombustible Material Heights and Mantel Location

Noncombustible Material Measurement	Requirements for Safe Installation with Wood Mantel, Shelf or Other Combustible Projection
12" or more	Adjustable canopy not required. Observe profiles shown in Figure 4.
8" minimum to 12"	Install adjustable canopy and observe profiles shown in Figure 5. or Extend heat resistant material to at least 12" and observe profiles shown in Figure 4.

Table 3

Step 3. Noncombustible materials (minimum requirements): To install the room heater without wood mantels, shelves or other combustible projections directly above the opening of the fireplace (firebox) refer to Figure 2 and Table 2. Note that at least 8" of noncombustible material must be installed above the heaters described in this manual.

Noncombustible materials, such as slate and marble, must be at least 1/2" thick.

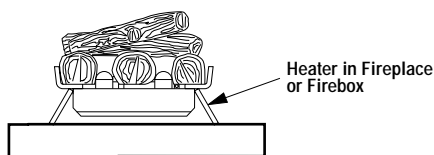
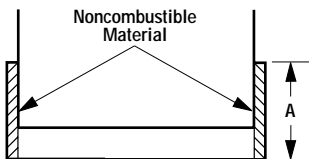

Figure 2

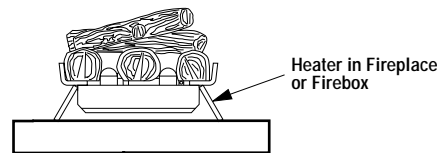
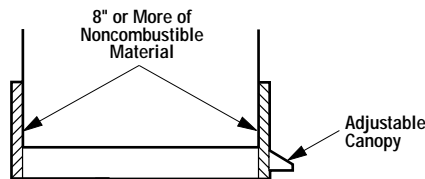

Figure 3

Step 4. Wood mantel, shelf or combustible projection requirements: To install a wood mantel, shelf or other combustible projection directly above the fireplace (firebox), refer to Table 3 and to Figures 4 and 5 for installation profiles.

If your mantel profile is unsafe, you may either:

- Raise the mantel to an acceptable height, or
- Remove the mantel.

NOTE: DIAGRAMS & ILLUSTRATION NOT TO SCALE.

Example: The bottom of the mantel may project from the wall a maximum of 2-1/2" at a minimum of 28" above the opening. The top shelf of the mantel may project a maximum of 6" at a minimum of 34-1/2" above the opening.

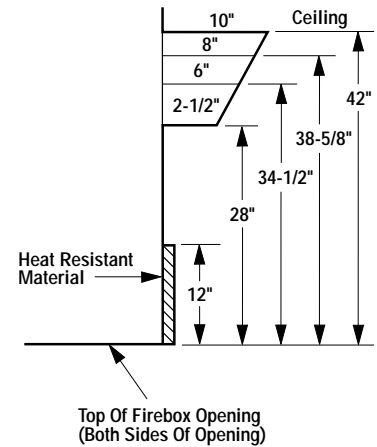

Figure 4

Example: The bottom of the mantel may project from the wall a maximum of 2-1/2" at a minimum of 8" above the opening. The top shelf of the mantel may project a maximum of 6" at a minimum of 14-1/2" above the opening.

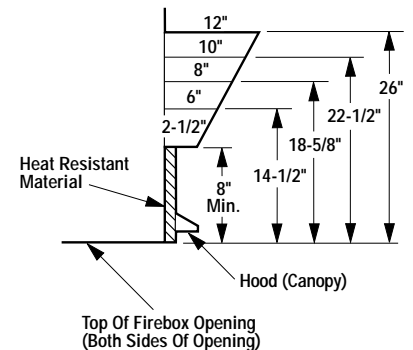

Figure 5

Step 5. Floor clearance: If combustible flooring materials, such as carpeting or asphalt tile, are to be located within 14" of the fireplace or firebox opening, the room heater base must be at least 5" above the combustible flooring material (Figure 6).

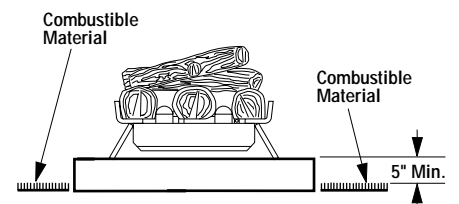

Figure 6

The room heater base may be lower than 5" above the combustible flooring materials if the combustible flooring materials are more than 14" from the fireplace or firebox opening (Figure 7).

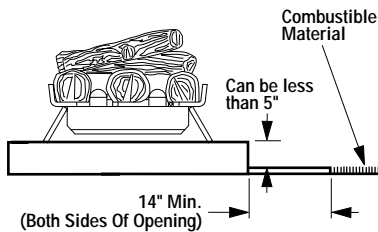

Figure 7

INSTALLATION

WARNING: DO NOT ALLOW FANS TO BLOW DIRECTLY INTO THE FIREPLACE. AVOID ANY DRAFTS THAT ALTER BURNER FLAME PATTERNS.

WARNING: DO NOT USE A BLOWER INSERT, HEAT EXCHANGER INSERT OR OTHER ACCESSORY NOT APPROVED FOR USE WITH THIS HEATER.

This appliance must not be operated without a fireplace screen installed. Fireplace screens must not impair the free flow of combustion air to the appliance.

Do not burn solid fuels in any fireplace equipped with this listed unvented gas room heater.

Installed decorative glass door enclosures must be fully opened when operating this listed unvented gas room heater.

Any outside air ducts and/or ash dumps that are part of the original solid fuel burning fireplace system must be fully closed and sealed at the time of installation of this listed unvented gas room heater.

WARNING: SPECIAL CARE IS REQUIRED IF YOU ARE INSTALLING THE UNIT INTO A SUNKEN FIREPLACE. YOU MUST RAISE THE FIREPLACE FLOOR TO ALLOW ACCESS TO GAS LOG CONTROLS. THIS WILL INSURE ADEQUATE AIR FLOW AND GUARD AGAINST SOOTING. RAISE THE FIREPLACE FLOOR USING NONCOMBUSTIBLE MATERIALS.

A qualified gas appliance installer must install this heater.

Check gas type: The gas supply must be the same as stated on the heater's rating plate. If the gas supply is different, DO NOT INSTALL the heater. Contact your dealer for the correct model.

Step 1. Placement of the Heater – Center the heater in the fireplace or firebox. Make certain the grate front feet sit inside the front edge of the fireplace or firebox clear of any operating screens.

Step 2. Connecting Gas Line – A qualified gas appliance installer must connect the gas room heater to the gas supply.

Consult all local codes.

Route gas line using techniques and materials prescribed by local and/or national codes. Only use gas line of 1/2" or greater diameter to allow full gas volume to the gas fireplace. Undue pressure loss will occur if the pipe is too small.

When rigid pipe is used, an ANSI approved manual shut-off valve and union must be installed upstream of the heater within the fireplace cavity.

Ensure that a sediment trap is installed in the existing gas line, if not, install a sediment trap upstream of the heater to prevent moisture and contaminants from passing through trap to the heater controls and burners. Failure to do so could prevent the heater from operating reliably.

An external regulator must be used on all propane (L.P.G.) heaters to reduce the supply tank pressure to 13" w.c. (maximum). Any copper tubing used to supply propane (L.P.G.) from the tank must be internally tinned.

IMPORTANT: HOLD HEATER VALVE SECURELY TO PREVENT MOVEMENT WHEN CONNECTING TO INLET GAS LINE

WARNING: CONNECTING DIRECTLY TO AN UNREGULATED PROPANE (L.P.G.) TANK MAY CAUSE AN EXPLOSION.

The heater gas inlet connection is 3/8" NPT at the regulator, made on the right side facing the heater. If a left side gas line is required, the gas line may be led under the rear of the heater to end at the right hand side for connection to the inlet. However, this method is not recommended. For an easier connection to the Unvented Gas Log Room Heaters, connection fittings have been supplied with the firebox. Cut and flare tubing to fit.

Checking Gas Connections

Secure all joints tightly using appropriate tools and sealing compounds (ensure propane resistant compounds are used in propane applications).

Turn on gas supply and test for gas leaks, using a gas leak test solution (also referred to as bubble leak solution).

Note: Using a soapy water solution (50% dish soap, 50% water) is an effective leak test solution but it is not recommended, because the soap residue that is left on the pipes/fittings can result in corrosion over time. **Never use an open flame to check for leaks.**

A. Light the appliance (refer to safety and lighting instructions on pages 12 and 14.

B. Brush all joints and connections with the gas leak test solution to check for leaks. If bubbles are formed, or gas odor is detected, turn the gas control knob to the "OFF" position. Either tighten or refasten the leaking connection and retest as described above.

C. When the gas lines are tested and leak free, be sure to rinse off the leak testing solution.

D. When the gas lines are tested and leak free, observe the individual tongues of flame on the burner. Make sure all ports are open and producing flame evenly across the burner. If any ports are blocked, or partially blocked, clean out the ports.

Gas Pressure Check

Check inlet gas pressure to ensure it is within the limits specified in the chart on page 2. Test gage connections are provided on the front of the gas control valve (identified A for the manifold and E for inlet pressure).

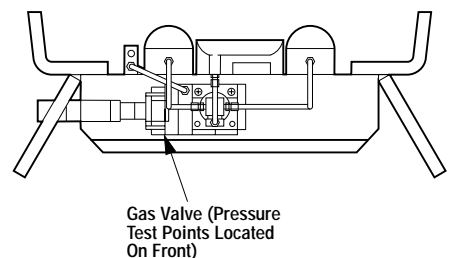

Figure 8

The pressure should be checked with the gas heater burning and the control set to high (3).

Replace the test point plugs after pressure measurement ensuring no gas leaks.

NOTE: DIAGRAMS & ILLUSTRATION NOT TO SCALE.

Step 3. Assembling the Logs

WARNING: DO NOT ADD EXTRA LOGS OR ORNAMENTS SUCH AS PINE CONES, VERMICULITE OR ROCK WOOL. USING THESE ADDED ITEMS CAN CAUSE SOOTING.

WARNING: DO NOT PLACE ANY LAVA ROCK ON LOGS OR BURNERS. THIS MAY CAUSE SOOTING. ONLY PLACE LAVA ROCK ON FLOOR OF FIREPLACE.

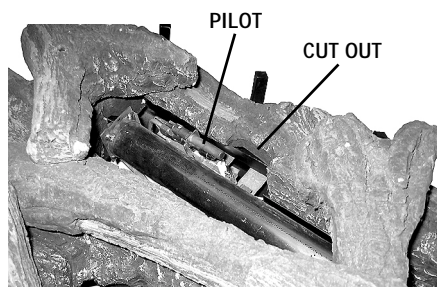

Figure 9

The heater includes a unitized set of eight ceramic fiber logs. The heater and logs are assembled as shown in *Figure 9*. Handle these logs with great care. The logs can be easily damaged, but when handled properly they can provide years of performance and enjoyment.

WARNING: FAILURE TO POSITION THE PARTS IN ACCORDANCE WITH THESE DIAGRAMS OR FAILURE TO USE ONLY PARTS SPECIFICALLY APPROVED WITH THIS HEATER MAY RESULT IN PROPERTY DAMAGE OR PERSONAL INJURY.

Periodically check the positioning of all logs.

Flame Appearance

REFER TO THE OPERATING INSTRUCTIONS LOCATED AT THE BACK OF THIS MANUAL BEFORE LIGHTING THE HEATER TO OBSERVE THE FLAMES.

Flames from the pilot, front and rear burner should be visually checked as soon as the heater is installed. In addition a periodic visual check of the flames should be made. The pilot flame should always be present when the heater is in operation (*Figure 10*).

WARNING: NO ADJUSTMENTS ARE TO BE MADE TO THE ODS PILOT SYSTEM. TAMPERING WITH THIS SYSTEM CAN BE EXTREMELY HAZARDOUS.

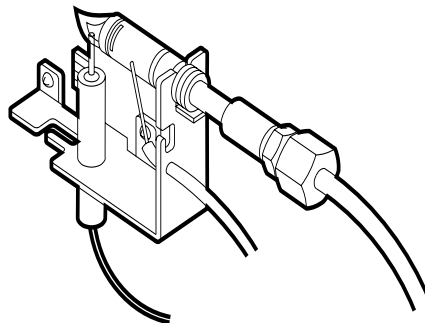

Figure 10

An incorrect pilot flame pattern is shown in *Figure 11*. This pilot flame will cause the thermocouple to cool. When the thermocouple cools, the log set will shut off. If pilot flame pattern is incorrect, or if log set shuts off, contact your service representative.

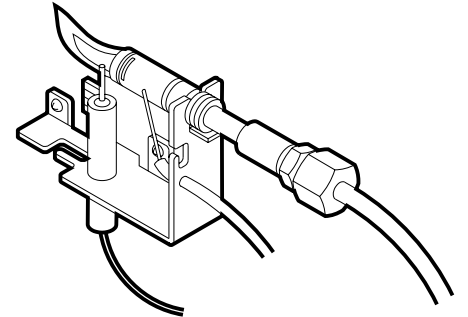
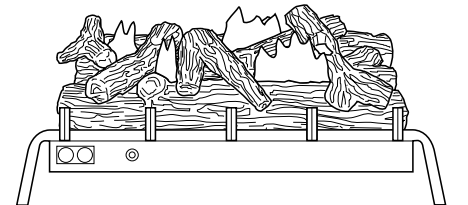

Figure 11

In normal operation, at full rate, after 15 minutes the following flame appearance should be observed:

Burner Flame Characteristics – The flames should be yellow. The flames should extend about 3 – 4" above the logs for natural gas and 2 – 3" above for propane (L.P.G.) gas (*Figure 12*).



Note: Propane Model Shown

Figure 12

CLEANING AND SERVICING

WARNING: TURN OFF THE UNVENTED GAS ROOM HEATER AND ALLOW TO COOL BEFORE CLEANING.

CAUTION: YOU MUST KEEP CONTROL AREAS, BURNERS AND CIRCULATING AIR PASSAGEWAYS OF FIREPLACE CLEAN. INSPECT THESE AREAS OF FIREPLACE BEFORE EACH USE. HAVE FIREPLACE AND CHIMNEY (IF APPLICABLE) INSPECTED YEARLY BY A QUALIFIED SERVICE PERSON. FIREPLACE MAY NEED MORE FREQUENT CLEANING DUE TO EXCESSIVE LINT FROM CARPETING, BEDDING MATERIAL, ETC.

Only limited cleaning will be required under the normal use of the heater. Dust the front grate, the top of the piezo cover and the control knob occasionally. Do not use cleaning fluids to clean the logs or any other part of the room heater.

Remove the logs, gently handling at each end. Use a vacuum cleaner to remove loose particles from the base and from around the burners. Gloves are recommended to prevent the fibers from pricking your skin. If the skin is pricked, wash gently with soap and water. Replace the logs as detailed in Step 3 Assembling the Logs.

If, after a period of use, the flames start to exhibit unusual shapes and behavior, or the burners fail to ignite smoothly, then the burner holes may require some cleaning. If this happens, it is preferable to contact your nearest dealer to get the appliance serviced.

REPLACEMENT PARTS

An exploded view of the room heater with numbered parts and a parts list can be found on page 16. All parts should be ordered through your Lennox distributor or dealer. Parts will be shipped at prevailing prices at time of order.

When ordering repair parts, always give the following information:

1. The model number of the heater.
2. The serial number of the heater.
3. The part number.
4. The description of the part.
5. The quantity required.
6. The installation date of the heater.

If you encounter any problems or have any questions concerning the installation of this heater, please contact your distributor. For the name of your nearest distributor contact:

**LHP
1110 West Taft Avenue
Orange, CA 92865**

ACCESSORIES

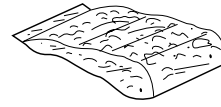

Decorative
Volcanic Stone

VFVS

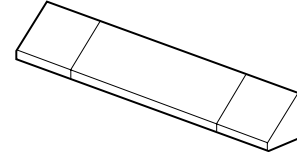

Adjustable Canopy
Brass
Black

AC - SPB
AC - BLK

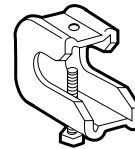

Damper Clamp

DCK

NOTE: DIAGRAMS & ILLUSTRATION NOT TO SCALE.

TROUBLESHOOTING GUIDE FOR UNVENTED GAS PRODUCTS

OBSERVED PROBLEM	POSSIBLE CAUSE	REMEDY
1. When igniter button is pressed, there is no spark at ODS/pilot.	A. Igniter electrode positioned wrong.	Replace igniter.
	B. Igniter electrode broken.	Replace igniter.
	C. Igniter electrode not connected to igniter cable.	Reconnect igniter cable.
	D. Igniter cable pinched or wet.	Free igniter cable if pinched by any metal or tubing. Keep igniter cable dry.
	E. Piezo igniter nut is loose.	Tighten nut.
	F. Broken igniter cable.	Replace igniter cable.
	G. Bad piezo igniter.	Replace piezo igniter.
2. Heater produces unwanted odors.	A. Heater burning vapors from paint, hair spray, glues, etc.	Ventilate room. Stop using odor-causing products while fireplace is running.
	B. Gas leak. See Warning statement on the front page.	Locate and correct all leaks.
3. Heater shuts off in use (ODS operates).	A. Not enough fresh air is available.	Open window and/or door for ventilation.
	B. Low line pressure.	Contact local gas company.
	C. ODS/pilot is partially clogged.	Clean ODS/pilot.
4. Gas odor even when control knob is in "OFF" position.	A. Gas leak. See Warning statement on the front page.	Locate and correct all leaks (see Checking Gas Connections, page 7).
	B. Control valve defective.	Replace control valve.
5. When igniter button is pressed, there is spark at ODS/pilot, but no ignition.	A. Gas supply turned off or manual shut-off valve closed.	Turn on gas supply or open manual shut-off valve.
	B. Control knob not in "PILOT" position.	Turn control knob to pilot position.
	C. Control knob not pressed in while in "PILOT" position.	Press in control knob while in pilot position.
	D. Air in gas lines when installed.	Continue holding down control knob. Repeat igniting operation until air is removed.
	E. ODS/pilot is clogged.	Replace ODS/pilot assembly or get it serviced.
	F. Gas regulator setting is not correct.	Replace gas regulator.
6. ODS/pilot lights, but flame goes out when control knob is released.	A. Control knob not fully pressed in.	Press in control knob fully.
	B. Control knob not pressed in long enough.	After ODS/pilot lights, keep control knob pressed in 30 seconds.
	C. Manual shut-off valve not fully open.	Fully open manual shut-off valve.
	D. Thermocouple connection loose at control valve.	Hand tighten until snug, then tighten ¼ turn more.
	E. Pilot flame not touching thermocouple, which allows thermocouple to cool, causing pilot flame to go out. This problem could be caused by one or both of the following: 1). Low gas pressure 2). Dirty or partially clogged ODS/pilot	1). Contact local gas company. 2). Replace ODS/pilot assembly or get pilot serviced.
	F. Thermocouple damaged.	Replace thermocouple.
	G. Control valve damaged.	Replace control valve.
7. Burner does not light after ODS/pilot is lit.	A. Burner orifice is clogged.	Clean burner or replace burner orifice.
	B. Burner orifice diameter is too small.	Replace burner orifice.
	C. Inlet gas pressure is too low.	Contact local gas company.
8. Delayed ignition of burner.	A. Manifold pressure is too low.	Contact local gas company.
	B. Burner orifice is clogged.	Clean burner or replace burner orifice.
9. Burner backfiring during combustion.	A. Burner orifice is clogged or damaged.	Clean burner or replace burner orifice.
	B. Burner damaged.	Replace burner.
	C. Gas regulator defective.	Replace gas regulator.
10. Slight smoke or odor during initial operation.	A. Vapors from paint or curing process of logs.	Problem will stop after a few hours of operation. SFC recommends running the heater with excess ventilation for the first few hours.
11. Heater produces a whistling noise when burner is lit.	A. Turning control knob to "HI" position when burner is cold.	Turn control knob to "LO" position and let warm up for a minute.
	B. Air in gas line.	Operate burner until air is removed from line. Have gas line checked by local gas company.
	C. Dirty or partially clogged burner orifice.	Clean burner or replace burner orifice.







OPERATING INSTRUCTIONS

FOR YOUR SAFETY READ BEFORE LIGHTING

WARNING: IF YOU DO NOT FOLLOW THESE INSTRUCTIONS EXACTLY, A FIRE OR EXPLOSION MAY RESULT CAUSING PROPERTY DAMAGE, PERSONAL INJURY OR LOSS OF LIFE.

- A. This heater has a pilot which must be lit by hand. When lighting the pilot, follow these instructions exactly.
- B. **BEFORE OPERATING** smell all around the heater area for gas. Be sure to smell next to the floor because some gas is heavier than air and will settle on the floor.
- WHAT TO DO IF YOU SMELL GAS**
- Do not try to light any appliance.
 - Do not touch any electric switch; do not use any phone in your building.
 - Immediately call your gas supplier from a neighbor's phone. Follow the gas supplier's instructions.
 - If you cannot reach your gas supplier, call the fire department.
- C. Use only your hand to push in or turn the gas control knob. Never use tools. If the knob will not push in or turn by hand, do not try to repair it, call a qualified service technician. Forced or attempted repair may result in a fire or explosion.
- D. Do not use this heater if any part has been under water. Immediately call a qualified service technician to inspect the appliance and to replace any part of the control system and any gas control which has been under water.

LIGHTING INSTRUCTIONS

1. Stop! Read the safety information above.
 2. Make sure manual shut-off valve is fully open.
 3. Locate gas control knob and piezo (*Figure 13*).
 4. Depress control knob in and turn clockwise  to the "OFF" position (*Figure 14*).
 5. Wait 5 minutes to clear out any gas. Then smell for gas, including near the floor. If you smell gas, **STOP!** Follow "B" in the safety information above. If you do not smell gas, go to the next step.
 6. The pilot is located on the right side in front of the burner (*Figure 15*).
 7. Depress control knob in and turn counterclockwise  to the "PILOT" position (*Figure 16*). Press the control knob all the way in for 5 seconds.
 8. With the control knob pressed in, push in and release the piezo igniter button to light the pilot.
 9. Hold the control knob in for a further 10 seconds to prevent the flame failure detector from shutting off the gas while the probe is warming up.
 10. Release the control knob while turning counterclockwise  to the "ON" Position (*Figure 17*). Then adjust "HI-LO" knob to preferred setting.
 - If the knob does not pop out when released, stop and immediately call your service technician or gas supplier.
 - If the pilot will not stay lit after several tries, depress and turn the gas control knob clockwise  to "OFF" and wait 30 seconds. Depress and turn knob counterclockwise  to "ON" and press igniter button again. If your pilot does not relight depress and turn control knob clockwise  to "OFF" and call your service technician or gas supplier.
 11. Wait 30 seconds before readjusting the heater when the control knob has been turned down to a lower setting.
- Note: If you are running the heater for the first time it will be necessary to press the control knob all the way in for 30 seconds to allow air to bleed out of the gas piping.*

TO TURN OFF GAS TO HEATER

1. Depress and turn control knob clockwise  to the "OFF" position (*Figure 18*).

MANUAL MATCH LIGHTING PROCEDURE — EMERGENCY ONLY

1. If the pilot cannot be lit with the piezo igniter, the heater can be manually lit with a match.
2. With the right hand, depress and turn the control knob counterclockwise  to the "ON" position. Hold in the knob.
3. Light the match and hold the flame to the end of the pilot and ignite the pilot.
4. Continue to hold control knob for an additional 10 seconds to insure pilot remains lit.
5. Release the control while turning control knob to desired setting.

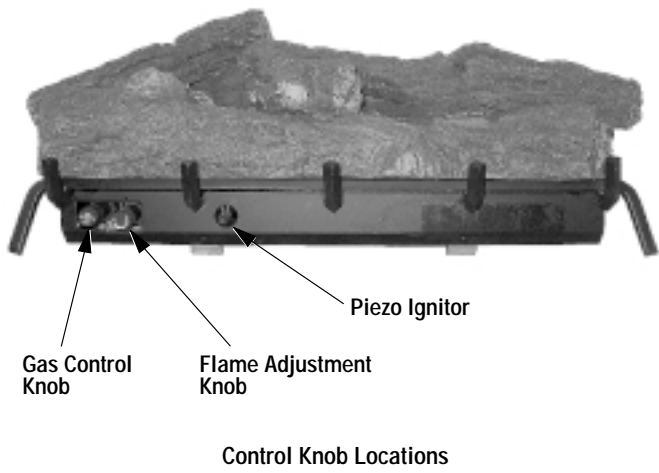

Figure 13

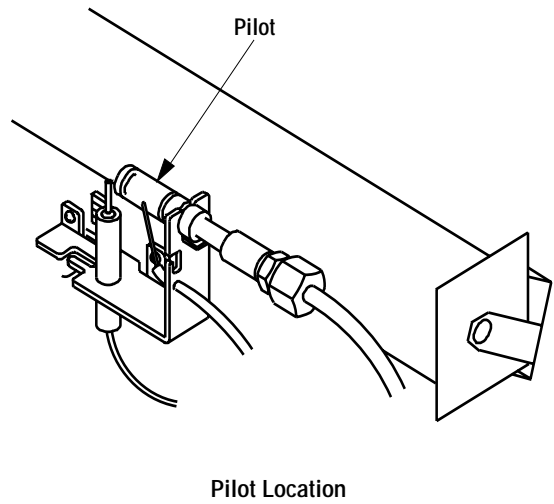
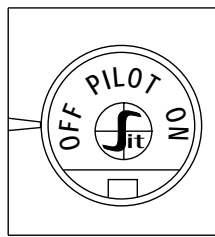
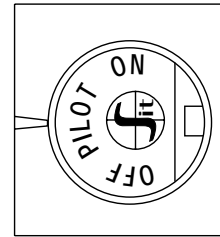

Figure 15



Turn Control Knob to "OFF" Position

Figure 14



Turn Control Knob to "PILOT" Position

Figure 16

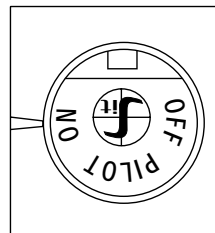

Turn Control Knob to "ON" Position

Figure 17

REPLACEMENT PARTS LIST

No.	Description	VFST-27VSN Part No.	VFST-27VSP Part No.
1.	Valve - Millivolt	903489	901917
2.	Pilot Assembly	901914	901915
3.	Piezo	111061	111061
4.	Piezo Wire	110361	110361
5.	Burner	112281	112281
	Burner (Valve Side)	112291	112291
6.	Burner Orifice (2 Each)	110389	110384
7.	Burner Crossover Tube	110321	110321
8.	Crossover Tube Orifice	110387	110388
9.	Log Set	100110	100110

REPLACEMENT PARTS

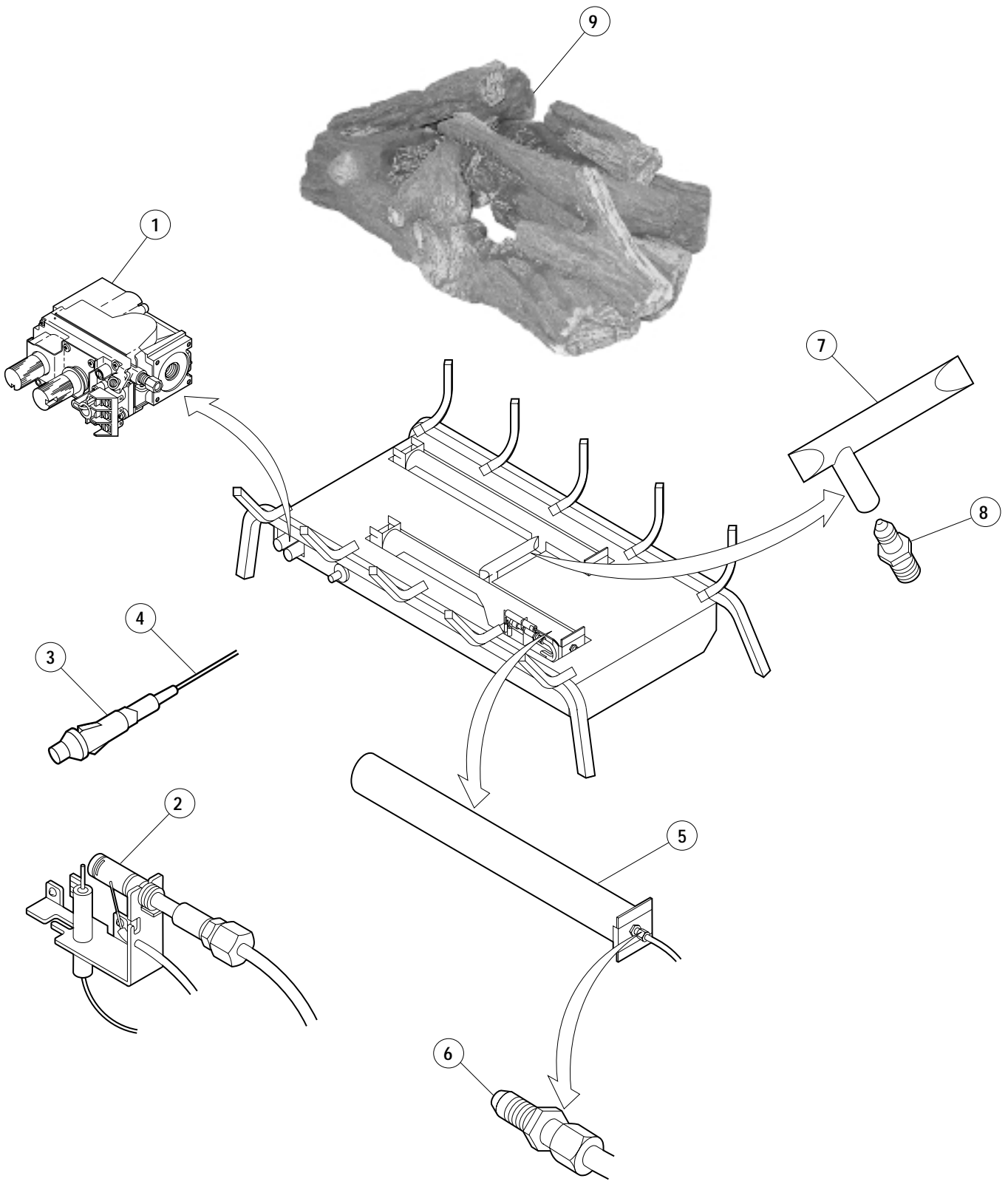

NOTE: DIAGRAMS & ILLUSTRATION NOT TO SCALE.

NOTE: THIS PAGE INTENTIONALLY LEFT BLANK.

The manufacturer reserves the right to make changes at any time, without notice, in design, materials, specifications, prices and also to discontinue colors, styles and products.
Consult your local distributor for fireplace code information.

Printed in U.S.A. © 1997 by Lennox Hearth Products
P/N 903588 REV. G 12/2007

LHP
1110 West Taft Avenue
Orange, CA 92865

Free Manuals Download Website

<http://myh66.com>

<http://usermanuals.us>

<http://www.somanuals.com>

<http://www.4manuals.cc>

<http://www.manual-lib.com>

<http://www.404manual.com>

<http://www.luxmanual.com>

<http://aubethermostatmanual.com>

Golf course search by state

<http://golfingnear.com>

Email search by domain

<http://emailbydomain.com>

Auto manuals search

<http://auto.somanuals.com>

TV manuals search

<http://tv.somanuals.com>