

Multilayer Chip Baluns For EGSM/Tx & Rx

Conformity to RoHS Directive

HHM Series HHM1763B2

SHAPES AND DIMENSIONS

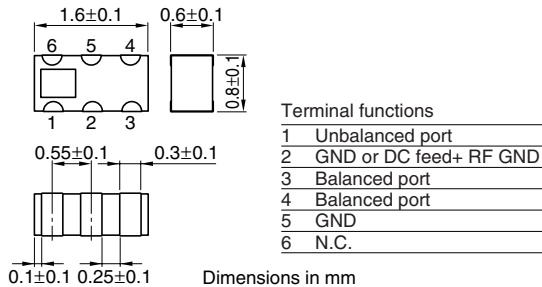

CIRCUIT DIAGRAM

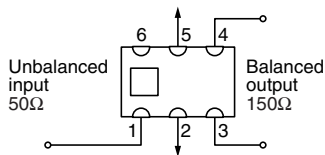

RECOMMENDED PC BOARD PATTERNS

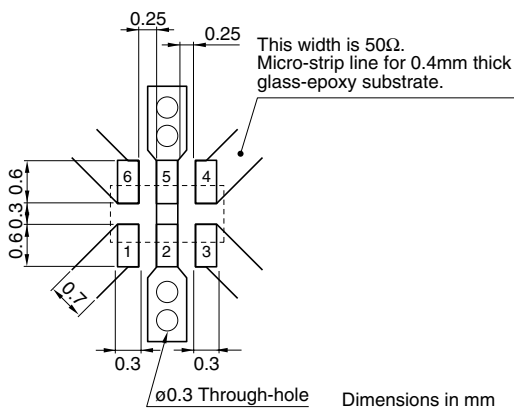

ELECTRICAL CHARACTERISTICS

Unbalanced impedance	50Ω	
Balanced impedance	150Ω	
Frequency range	880 to 960MHz	
Unbalanced port return loss	10dB min.	
Phase imbalance at balanced port	180±10deg.	
Amplitude imbalance at balanced port	0±1.0dB	
Insertion loss	1.4dB max.	
Temperature range	Operating	-40 to +85°C
	Storage	-40 to +85°C
Packaging style and quantities	4000pieces/reel	

• Conformity to RoHS Directive: This means that, in conformity with EU Directive 2002/95/EC, lead, cadmium, mercury, hexavalent chromium, and specific bromine-based flame retardants, PBB and PBDE, have not been used, except for exempted applications.

• All specifications are subject to change without notice.

FREQUENCY CHARACTERISTICS

Unbalance 50Ω/Balance 150Ω

RETURN LOSS

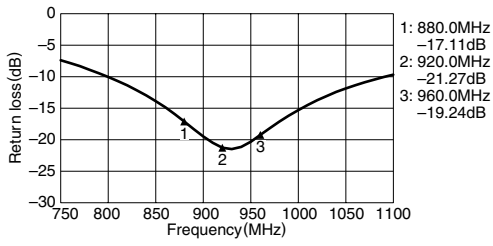

AMPLITUDE BALANCE

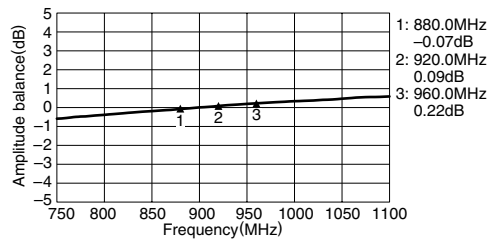

INSERTION LOSS

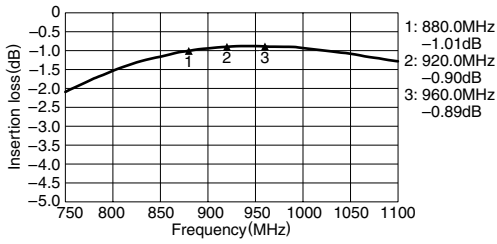

PHASE BALANCE

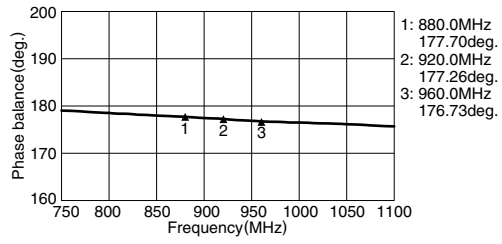

• All specifications are subject to change without notice.

Free Manuals Download Website

<http://myh66.com>

<http://usermanuals.us>

<http://www.somanuals.com>

<http://www.4manuals.cc>

<http://www.manual-lib.com>

<http://www.404manual.com>

<http://www.luxmanual.com>

<http://aubethermostatmanual.com>

Golf course search by state

<http://golfingnear.com>

Email search by domain

<http://emailbydomain.com>

Auto manuals search

<http://auto.somanuals.com>

TV manuals search

<http://tv.somanuals.com>