

# AC Input

Conformity to RoHS Directive

## Single Output, General-Purpose, UL/C-UL/TÜV Approved

### J Series JBW(10 to 150W)

#### FEATURES

- Compact and low price.
- Wide input voltage range.
- Safety standards approved.
- Corresponds to products with CE marking.
- Full lineup of output power 10 to 150W
- Open frame
- Meets conducted noise standard FCC Class B.
- Warranty period: 3 years
- Specific bromine inflammable materials (PBDPEs, PBBs) are not included in use.
- It is a product conforming to RoHS directive.

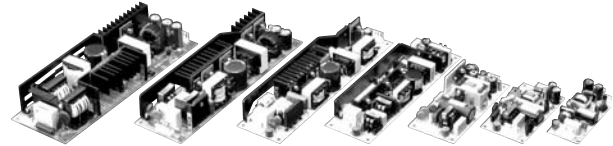

#### APPLICATIONS

Measuring equipment, robotics, automation equipment, information processing equipment, security systems, amusement equipment, etc.

#### SAFETY STANDARDS

UL60950-1, CSA C22.2 No.60950-1(C-UL), EN60950-1(TÜV), approved.

#### EMC REGULATIONS

- FCC Class-B, VCCI Class-B, EN-55011-B and EN55022-B meet.
- Harmonic current requirement EN61000-3-2 meet(50 to 150W).

#### PRODUCT IDENTIFICATION

JBW	05	-	2R0
(1)	(2)		(3)

(1)Series name

(2)Rated output voltage

(3)Rated output current(R: Decimal point)

#### PART NUMBERS AND RATINGS

Output voltage (V)	10W Type		15W Type		30W Type		50W Type	
	Current(A)	Part No.	Current(A)	Part No.	Current(A)	Part No.	Current(A)	Part No.
5	2	JBW05-2R0	3	JBW05-3R0	6	JBW05-6R0	10	JBW05-10R
12	0.9	JBW12-0R9	1.3	JBW12-1R3	2.5	JBW12-2R5	4.3	JBW12-4R3
15	0.7	JBW15-0R7	1	JBW15-1R0	2	JBW15-2R0	3.5	JBW15-3R5
24	0.5	JBW24-0R5	0.7	JBW24-0R7	1.3	JBW24-1R3	2.1	JBW24-2R1

Output voltage (V)	75W Type		100W Type		150W Type	
	Current(A)	Part No.	Current(A)	Part No.	Current(A)	Part No.
5	15	JBW05-15R	20	JBW05-20R	30	JBW05-30R
12	6.3	JBW12-6R3	8.5	JBW12-8R5	12.5	JBW12-12R
15	5.0	JBW15-5R0	6.7	JBW15-6R7	10	JBW15-10R
24	3.2	JBW24-3R2	4.3	JBW24-4R3	6.3	JBW24-6R3
48	—	—	—	—	3.2	JBW48-3R2

- 3.3 and 48V models(75 to 150W type) are made to order.

• Conformity to RoHS Directive: This means that, in conformity with EU Directive 2002/95/EC, lead, cadmium, mercury, hexavalent chromium, and specific bromine-based flame retardants, PBB and PBDE, have not been used, except for exempted applications.

• All specifications are subject to change without notice.

## JBW10W Type

### SPECIFICATIONS AND STANDARDS

Part No.		JBW05-2R0	JBW12-0R9	JBW15-0R7	JBW24-0R5
Rated output voltage and current*		5V • 2A	12V • 0.9A	15V • 0.7A	24V • 0.5A
Maximum output power	W	10	10.8	10.5	12
Input conditions					
Input voltage Eac/Edc	V	85 to 265[Rating: 100 to 240]/110 to 370			
Input frequency	Hz	47 to 440[Rating: 50 to 60](Single phase)			
Input current	A	0.25typ./0.35max. [AC.100V]0.15typ./0.25max.[AC.240V]			
Fuse rating	A	2[AC.250V, built-in]			
Surge current	A	15typ.(20max.)[AC.100V]30typ.(40max.)[AC.240V] 1st surge current, cold start, reset after 1s minimum.			
Leakage current	mA	0.1typ./0.75max.[AC.100V, 60Hz]0.15typ./0.75max.[AC.240V, 60Hz]			
Power factor		0.6typ./0.45typ.[AC.100/240V]			
Efficiency	%	71typ.[AC.100V]	78typ.[AC.100V]	79typ.[AC.100V]	82typ.[AC.100V]
	%	71typ.[AC.240V]	79typ.[AC.240V]	80typ.[AC.240V]	83typ.[AC.240V]
Output characteristics					
Output voltage Edc	V	5	12	15	24
Voltage variable range Edc	V	Fixed	Fixed	Fixed	Fixed
Maximum output current	A	2	0.9	0.7	0.5
Minimum output current	A	0	0	0	0
Overvoltage threshold Edc	V	5.75min.	13.8min.	17.25min.	27.6min.
Overcurrent threshold	A	2.5min.	1.12min.	0.87min.	0.62min.
Voltage stability	Source effect	% 0.4max.[Within the input voltage range]			
	Load effect	% 0.8max.[0 to 100% load]			
	Temperature effect	% 1max.[Ambient temperature: -10 to +50°C]			
	Drift(Time effect)	% 0.4max.[25°C, input and output ratings, after input voltage ON for 30min to 8h]			
	Recovery	% ±4max.[50 to 100% sudden load change]			
Ripple Ep-p	mV	80max.	120max.	120max.	120max.
Ripple noise Ep-p	mV	120max.	150max.	150max.	150max.
Start up time	ms	700max.(200typ.)/700max.(200typ.) [AC.100/240V]			
Hold up time	ms	15typ/140typ [AC.100/240V]			
Auxiliary functions					
Indicator display		No			
Overvoltage protection		Zenor diode clamp method, output may latch up depending on the condition.			
Overcurrent protection		Fold back type, automatic recovery.			
Remote ON-OFF		No			
Remote sensing		No			
Parallel operation		Impossible			
Series operation		Impossible			
Output voltage external variable function		No			
Standards					
Safety standards		UL60950-1, CSA C22.2 No.60950-1(C-UL), EN60950-1(TÜV) approved.			
Noise terminal voltage		FCC-B, VCCI-B, EN55011-B, EN55022-B meet.			
Input harmonics current requirement		No			
Constructions					
External dimensions	mm	21×36×95[H×W×L]			
Weight	g	50max.			
Mounting method		Can be attached to 1 side.			
Case material		No(PWB Material: CEM3)			

\* Current rating(maximum output current) is determined for -10 to +50°C. Derating is required when used outside this temperature range.

• Optional input, output cable kits are available at a separate price.

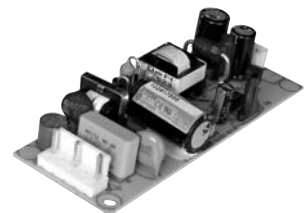

# JBW10W Type

## SHAPES AND DIMENSIONS

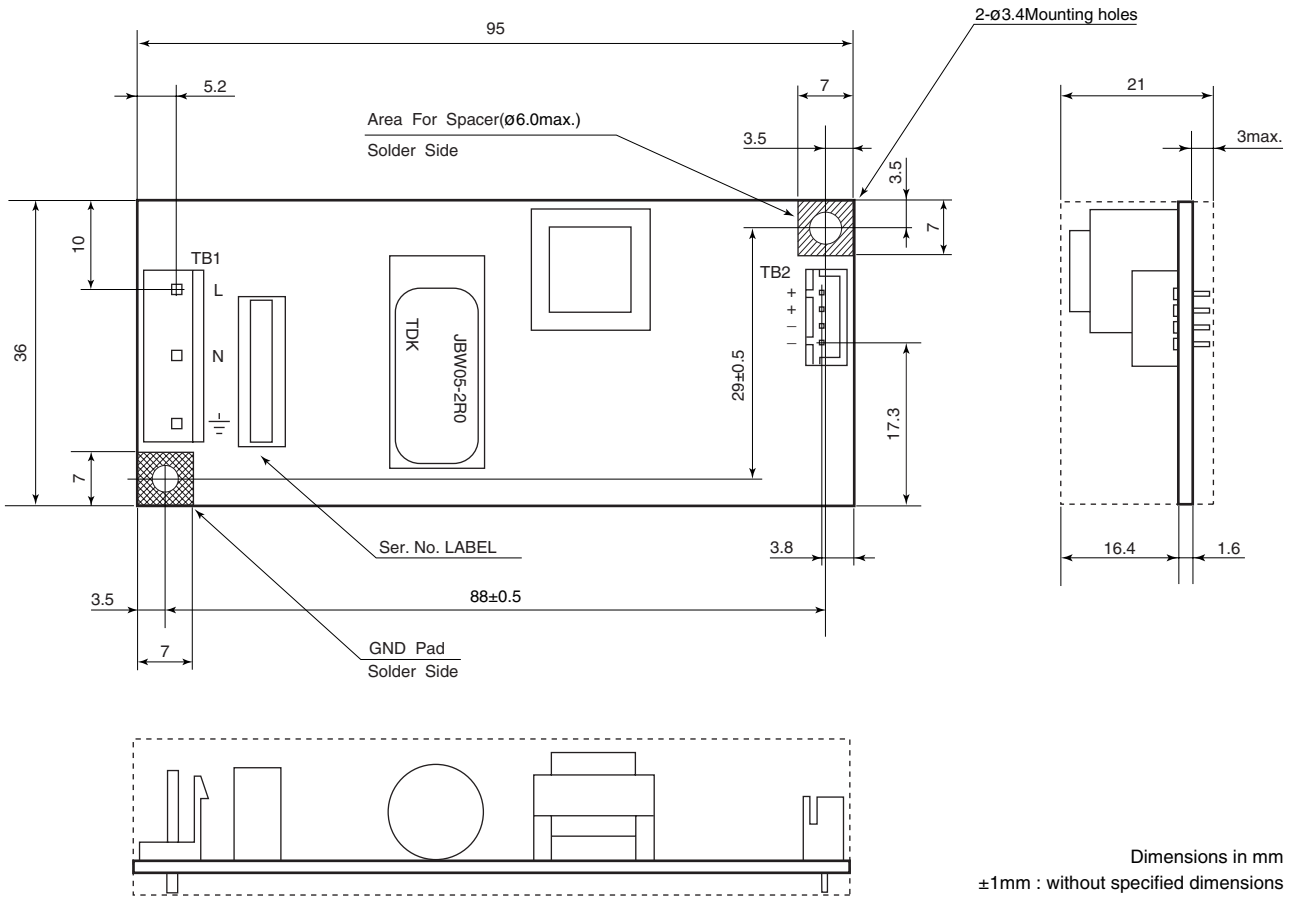

## TERMINAL DESIGNATION

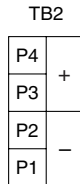
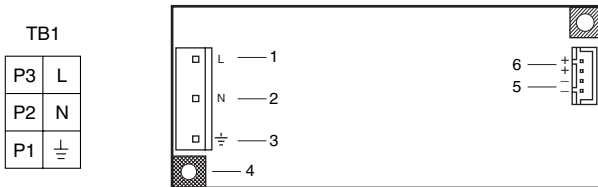

Terminal No.	Designations
1	Input terminal(L)
2	Input terminal(N)
3	Frame ground terminal(G)
4	Ground pad
5	Output terminal(-)
6	Output terminal(+)

Connector made by	Power supply side connector	Cable Side Housing	Terminal
Japan Solderless Terminal Co., Ltd.			
Input Connector(TB1) VH Series	B3P5-VH-B	VHR-5N	SVH-21T-P1.1
Output Connector(TB2) XH Series	B4B-XH-2	XHP-4	SXH-001T-P0.6
LCE			
Input Connector(TB1) P101 Series	P101-05-2/4	H101-05	T101
Output Connector(TB2) P221 Series	P221-04	H221-04	T221-01

Option Set	Part No.
	4EU20G054

• All specifications are subject to change without notice.

## JBW15W Type

### SPECIFICATIONS AND STANDARDS

Part No.	JBW05-3R0	JBW12-1R3	JBW15-1R0	JAW24-0R7
Rated output voltage and current*	5V • 3A	12V • 1.3A	15V • 1.0A	24V • 0.7A
Maximum output power	W	15	15.6	16.8
Input conditions				
Input voltage Eac/Edc	V	85 to 265[Rating: 100 to 240]/110 to 370		
Input frequency	Hz	47 to 440[Rating: 50 to 60](Single phase)		
Input current	A	0.36typ./0.43max.[AC.100V]0.2typ./0.24max.[AC.240V]		
Fuse rating	A	2[AC.250V, built-in]		
Surge current	A	15typ./19.5max.[AC.100V]30typ./41max.[AC.240V] 1st surge current, cold start, reset after 1s minimum.		
Leakage current	mA	0.2typ./0.75max.[AC.100V, 60Hz]0.3typ./0.75max.[AC.240V, 60Hz]		
Power factor		0.6typ./0.45typ.[AC.100/240V]		
Efficiency	%	72typ.[AC.100V]	76typ.[AC.100V]	76typ.[AC.100V]
	%	72typ.[AC.240V]	74typ.[AC.240V]	74typ.[AC.240V]
Output characteristics				
Output voltage Edc	V	5	12	15
Voltage variable range Edc	V	Fixed	Fixed	Fixed
Maximum output current	A	3	1.3	1
Minimum output current	A	0	0	0
Overvoltage threshold Edc	V	5.75min.	13.8min.	17.25min.
Overcurrent threshold	A	3.15min.	1.37min.	1.05min.
Voltage stability	Source effect	%	0.4max.[Within the input voltage range]	
	Load effect	%	0.8max.[0 to 100% load]	
	Temperature effect	%	1max.[Ambient temperature: -10 to +50°C]	
	Drift(Time effect)	%	0.4max.[25°C, input and output ratings, after input voltage ON for 30min to 8h]	
	Recovery	%	±4max.[50 to 100% sudden load change]	
Ripple Ep-p	mV	80max.	120max.	120max.
Ripple noise Ep-p	mV	120max.	150max.	150max.
Start up time	ms	200max.(25typ.)/100max.(25typ.)[AC.100/240V]		200max.(40typ.)/100max.(40typ.)[AC.100/240V]
Hold up time	ms	13typ./150typ. [AC.100/240V]		
Auxiliary functions				
Indicator display		No		
Overvoltage protection		Zenor diode clamp method, output may latch up depending on the condition.		
Overcurrent protection		Rectangular type, automatic recovery.		
Remote ON-OFF		No		
Remote sensing		No		
Parallel operation		Impossible		
Series operation		Impossible		
Output voltage external variable function		No		
Standards				
Safety standards		UL60950-1, CSA C22.2 No.60950-1(C-UL), EN60950-1(TÜV) approved.		
Noise terminal voltage		FCC-B, VCCI-B, EN55011-B, EN55022-B meet.		
Input harmonics current requirement		No		
Constructions				
External dimensions	mm	22.6×50×95[H×W×L]		
Weight	g	80max.		
Mounting method		Can be attached to 1 side.		
Case material		No(PWB Material: CEM3)		

\* Current rating(maximum output current) is determined for -10 to +50°C. Derating is required when used outside this temperature range.

• Optional input, output cable kits are available at a separate price.

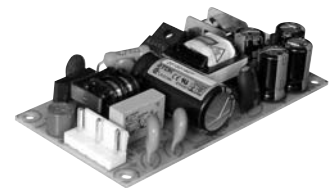

# JBW15W Type

## SHAPES AND DIMENSIONS

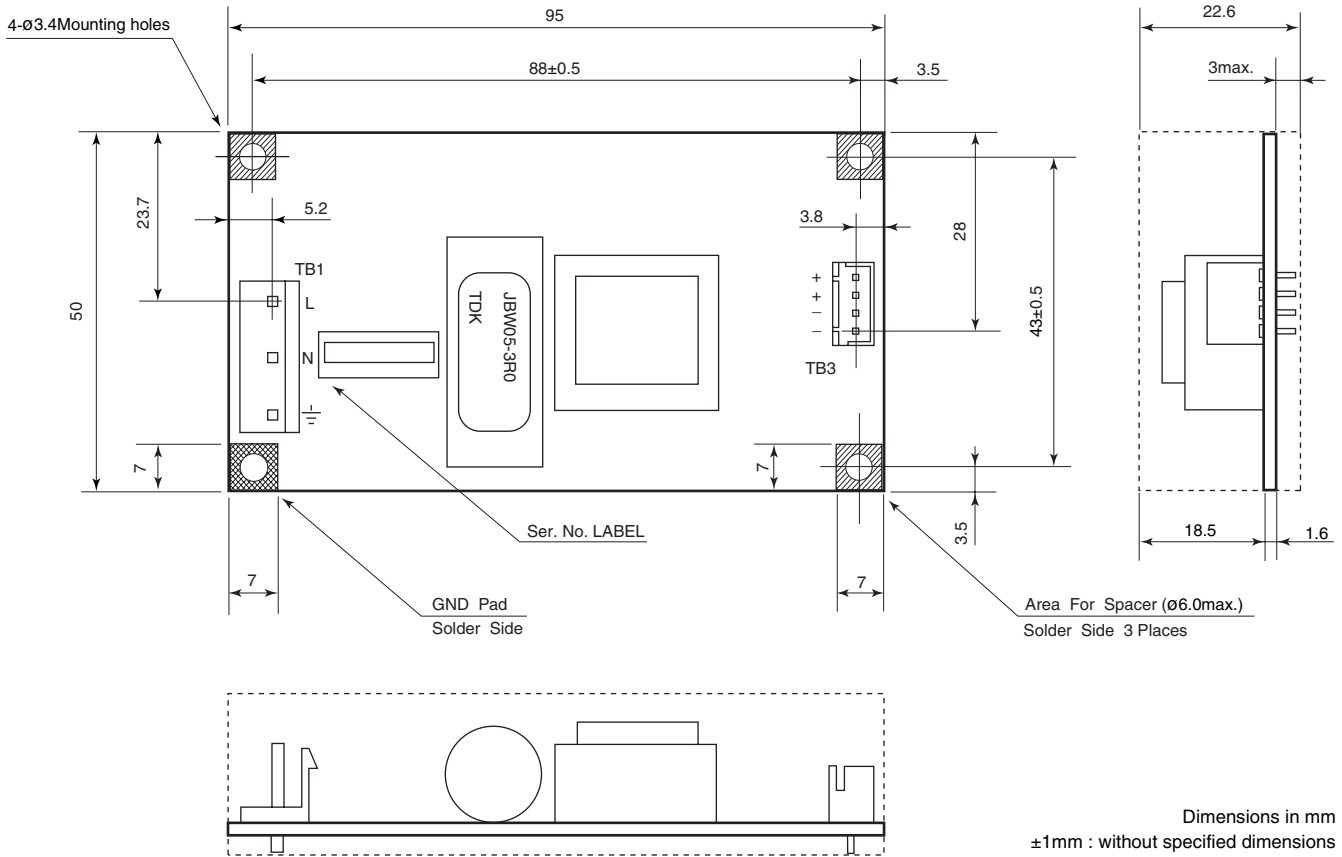

Dimensions in mm  
±1mm : without specified dimensions

## TERMINAL DESIGNATION

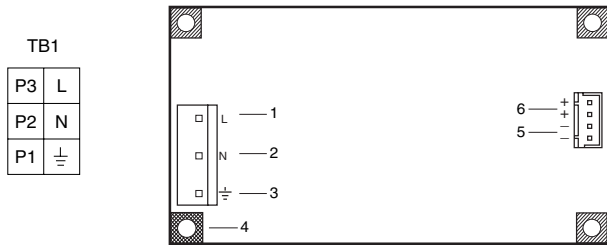

Terminal No.	Designations
1	Input terminal(L)
2	Input terminal(N)
3	Frame ground terminal(G)
4	Ground pad
5	Output terminal(-)
6	Output terminal(+)

Connector made by	Power supply side connector	Cable Side	
		Housing	Terminal
Japan Solderless Terminal Co., Ltd.			
Input Connector(TB1) VH Series	B3P5-VH-B	VHR-5N	SVH-21T-P1.1
Output Connector(TB3) XH Series	B4B-XH-2	XHP-4	SXH-001T-P0.6
LCE			
Input Connector(TB1) P101 Series	P101-05-2/4	H101-05	T101
Output Connector(TB3) P221 Series	P221-04	H221-04	T221-01

Option Set	Part No.
	4EU20G054

• All specifications are subject to change without notice.

## JBW30W Type

### SPECIFICATIONS AND STANDARDS

Part No.	JBW05-6R0	JBW12-2R5	JBW15-2R0	JAW24-1R3
Rated output voltage and current*	5V • 6A	12V • 2.5A	15V • 2A	24V • 1.3A
Maximum output power	W	30	30	31.2
Input conditions				
Input voltage Eac/Edc	V	85 to 265[Rating: 100 to 240]/110 to 370		
Input frequency	Hz	47 to 440[Rating: 50 to 60](Single phase)		
Input current	A	0.65typ./0.86max.[AC.100V]0.35typ./0.48max.[AC.240V]		
Fuse rating	A	2[AC.250V, built-in]		
Surge current	A	15typ./30max.[AC.100V]30typ./60max.[AC.240V] 1st surge current, cold start, reset after 1s minimum.		
Leakage current	mA	0.35typ./0.75max.[AC.100V, 60Hz]0.5typ./0.75max.[AC.240V, 60Hz]		
Power factor		0.6typ./0.45typ.[AC.100/240V]		
Efficiency	%	75typ.[AC.100V]	78typ.[AC.100V]	79typ.[AC.100V]
	%	77typ.[AC.240V]	79typ.[AC.240V]	80typ.[AC.240V]
Output characteristics				
Output voltage Edc	V	5	12	15
Voltage variable range Edc	V	Fixed	Fixed	Fixed
Maximum output current	A	6	2.5	2
Minimum output current	A	0	0	0
Overvoltage threshold Edc	V	5.6min.	13.3min.	16.6min.
Overcurrent threshold	A	6.3min.	2.7min.	2.1min.
Voltage stability	Source effect	%	0.4max.[Within the input voltage range]	
	Load effect	%	0.8max.[0 to 100% load]	
	Temperature effect	%	2max.[Ambient temperature: -10 to +50°C]	
	Drift(Time effect)	%	0.4max.[25°C, input and output ratings, after input voltage ON for 30min to 8h]	
	Recovery	%	±4max.[50 to 100% sudden load change]	
Ripple Ep-p	mV	80max.	120max.	120max.
Ripple noise Ep-p	mV	120max.	150max.	150max.
Start up time	ms	650max.(350typ.)/320max.(130typ.)[AC.100/240V]		
Hold up time	ms	20typ./160typ.[AC.100/240V]		
Auxiliary functions				
Indicator display		No		
Overvoltage protection		Voltage shut-down type.		
Overcurrent protection		Rectangular type(Winker operation), automatic recovery.		
Remote ON-OFF		No		
Remote sensing		No		
Parallel operation		Impossible		
Series operation		Impossible		
Output voltage external variable function		No		
Standards				
Safety standards		UL60950-1, CSA C22.2 No.60950-1(C-UL), EN60950-1(TÜV) approved.		
Noise terminal voltage		FCC-B, VCCI-B, EN55011-B, EN55022-B meet.		
Input harmonics current requirement		No		
Constructions				
External dimensions	mm	26×55×122[H×W×L]		
Weight	g	150max.		
Mounting method		Can be attached to 1 side.		
Case material		No(PWB Material: CEM3)		

\* Current rating(maximum output current) is determined for -10 to +50°C. Derating is required when used outside this temperature range.

• Optional input, output cable kits are available at a separate price.

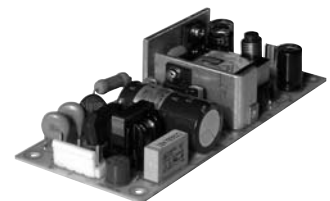

# JBW30W Type

## SHAPES AND DIMENSIONS

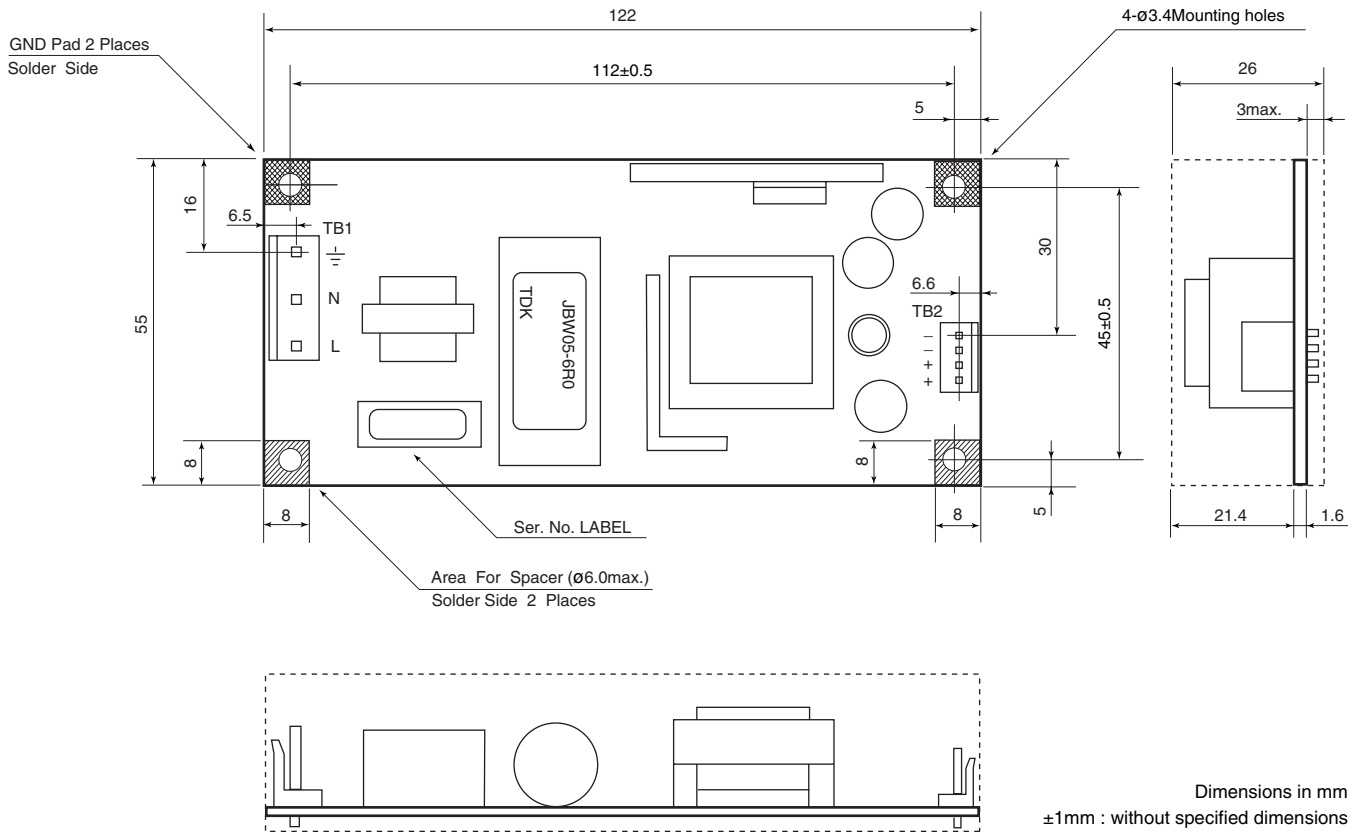

Dimensions in mm  
±1mm : without specified dimensions

## TERMINAL DESIGNATION

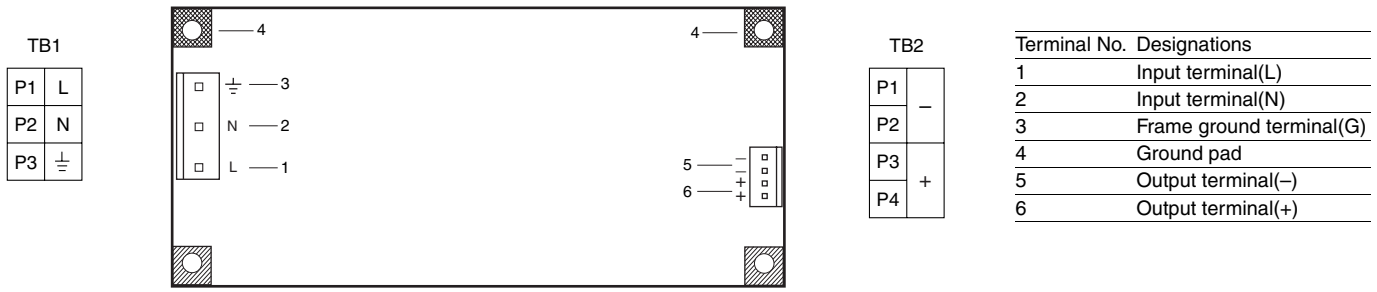

Connector made by	Power supply side connector	Cable Side Housing	Terminal
Japan Solderless Terminal Co., Ltd.			
Input Connector(TB1) VH Series	B3P5-VH-B	VHR-5N	SVH-21T-P1.1
Output Connector(TB2) VH Series	B4P-VH-B	VHR-4N	SVH-21T-P1.1
LCE			
Input Connector(TB1) P101 Series	P101-05-2/4	H101-05	T101
Output Connector(TB2) P101 Series	P101-04	H101-04	T101

Option	Part No.
Set	4EU20G057

• All specifications are subject to change without notice.

## JBW50W Type

### SPECIFICATIONS AND STANDARDS

Part No.		JBW05-10R	JBW12-4R3	JBW15-3R5	JBW24-2R1
Rated output voltage and current*1		5V • 10A	12V • 4.3A	15V • 3.5A	24V • 2.1A
Maximum output power	W	50	51.6	52.5	50.4
Input conditions					
Input voltage Eac/Edc*2	V	85 to 265[Rating: 100 to 240]/120 to 375			
Input frequency	Hz	47 to 66[Rating: 50 to 60](Single phase)			
Input current	A	0.7typ./0.88max. [AC.100V]0.35typ./0.5max. [AC.240V]			
Fuse rating	A	3.15[AC.250V, built-in]			
Surge current	A	15typ.(30max.)[AC.100V]40typ.(60max.)[AC.240V] cold start			
Leakage current	mA	0.35typ./0.75max.[AC.100V, 60Hz]0.5typ./0.75max.[AC.240V, 60Hz]			
Power factor		0.99typ./0.93typ.[AC.100/240V]			
Efficiency	%	77typ.[AC.100V]	80typ.[AC.100V]	80typ.[AC.100V]	81typ.[AC.100V]
	%	79typ.[AC.240V]	81typ.[AC.240V]	81typ.[AC.240V]	83typ.[AC.240V]
Output characteristics					
Output voltage Edc	V	5	12	15	24
Voltage variable range Edc	V	4.5 to 5.5	10.8 to 13.2	13.5 to 16.5	21.6 to 26.4
Maximum output current	A	10	4.3	3.5	2.1
Minimum output current	A	0	0	0	0
Overvoltage threshold Edc	V	5.75 to 6.9	13.8 to 16.8	17.2 to 21	27.6 to 33.6
Overcurrent threshold	A	10.5min.	5.4min.	4.4min.	2.7min.
Voltage stability	Source effect	% 0.4max.[Within the input voltage range]			
	Load effect	% 0.8max.[0 to 100% load]			
	Temperature effect	% 1max.[Ambient temperature: -10 to +50°C]			
	Drift(Time effect)	% 0.4max.[25°C, input and output ratings, after input voltage ON for 30min to 8h]			
	Recovery	% ±4max.[50 to 100% sudden load change]			
Ripple Ep-p	mV	80max.	120max.	120max.	120max.
Ripple noise Ep-p	mV	120max.	150max.	150max.	150max.
Start up time	ms	500max.(400typ.)/500max.(400typ.) [AC.100/240V]			
Hold up time	ms	20typ./20typ. [AC.100/240V]			
Auxiliary functions					
Indicator display		No			
Overvoltage protection		Voltage shut-down type.			
Overcurrent protection		Rectangular type, automatic recovery.			
Remote ON-OFF		No			
Remote sensing		No			
Parallel operation		Impossible			
Series operation		Possible			
Output voltage external variable function		No			
Standards					
Safety standards		UL60950-1, CSA C22.2 No.60950-1(C-UL), EN60950-1(TÜV) approved.			
Noise terminal voltage		FCC-B, VCCI-B, EN55011-B, EN55022-B meet.			
Input harmonics current requirement		EN61000-3-2 meet.			
Constructions					
External dimensions	mm	26×55×190[H×W×L]			
Weight	g	220max.			
Mounting method		Can be attached to 1 side.			
Case material		No(PWB Material: CEM3)			

\*1 Current rating(maximum output current) is determined for -10 to +50°C. Derating is required when used outside this temperature range.

\*2 Please note that the deterioration of parts is occasionally caused when operating for a long time(over 10 minutes) with the voltage below the range of the input voltage.

• Optional input, output cable kits are available at a separate price.

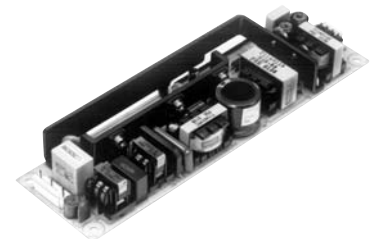



# JBW50W Type

## SHAPES AND DIMENSIONS

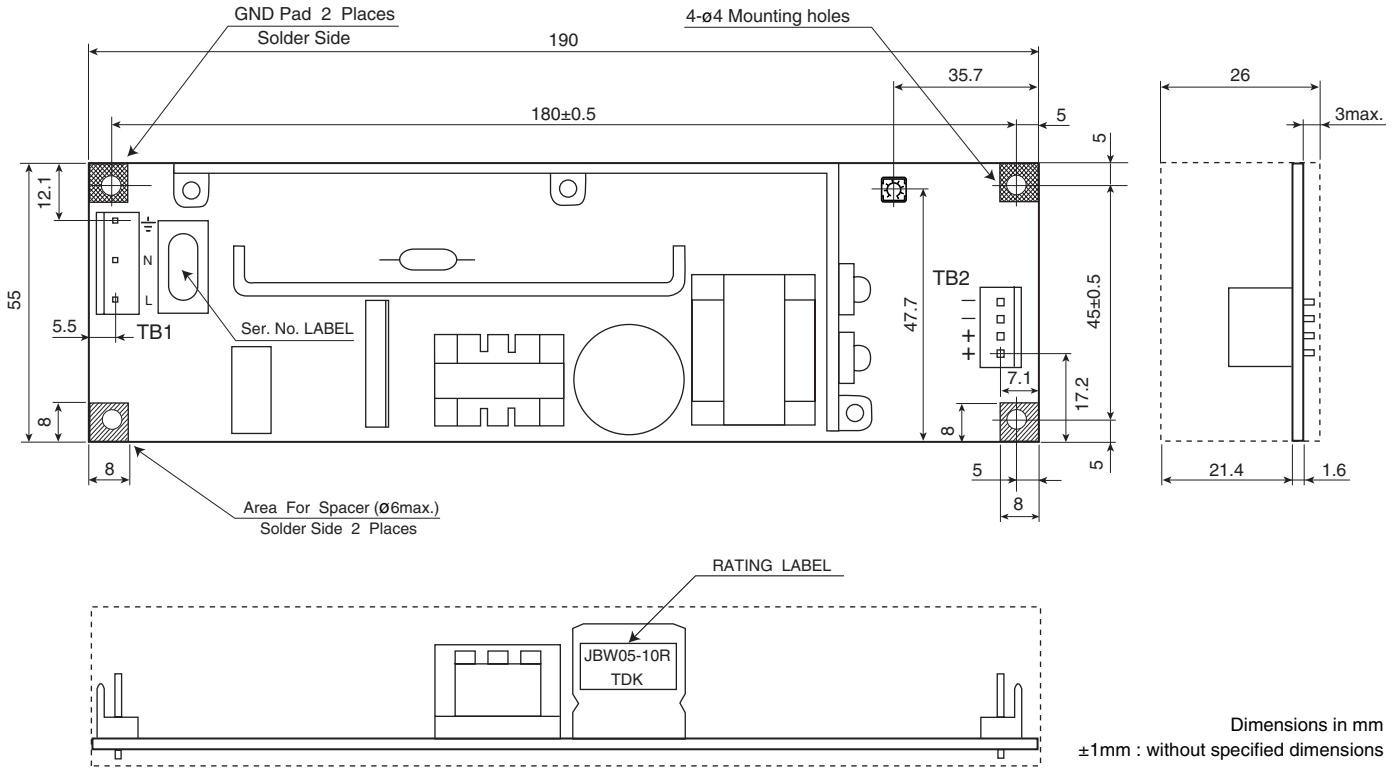

## TERMINAL DESIGNATION

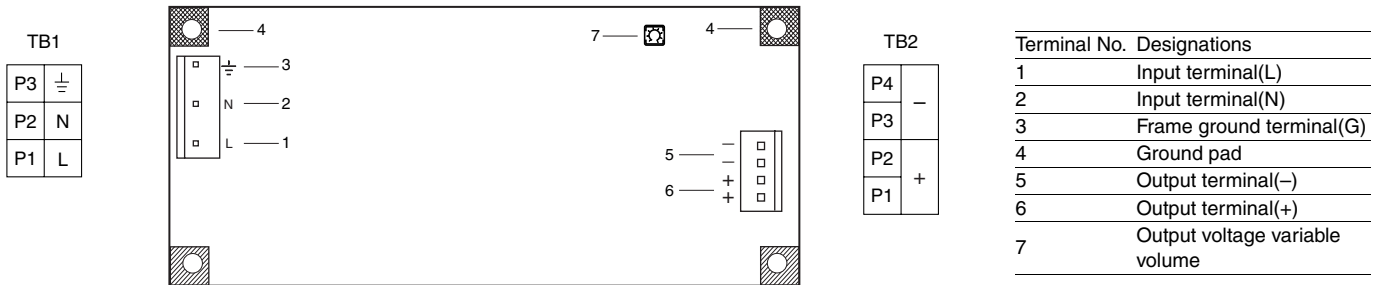

Connector made by	Power supply side connector	Cable Side	
		Housing	Terminal
Japan Solderless Terminal Co., Ltd.			
Input Connector(TB1) VH Series	B3P5-VH-B	VHR-5N	SVH-21T-P1.1
Output Connector(TB2) VH Series	B4P-VH-B	VHR-4N	SVH-21T-P1.1
LCE			
Input Connector(TB1) P101 Series	P101-05-2/4	H101-05	T101
Output Connector(TB2) P101 Series	P101-04	H101-04	T101

Option Set	Part No.
	4EU20G057

• All specifications are subject to change without notice.

## JBW75W Type

### SPECIFICATIONS AND STANDARDS

Part No.	JBW05-15R	JBW12-6R3	JBW15-5R0	JBW24-3R2
Rated output voltage and current	5V • 15A	12V • 6.3A	15V • 5.0A	24V • 3.2A
Maximum output power	W	75	75	76.8
Input conditions				
Input voltage Eac/Edc	V	85 to 265[Rating: 100-240]/120 to 370		
Input frequency	Hz	47 to 66		
Input current	A	1.6/0.8max.[100-240V]		
Fuse rating	A	3.15		
Surge current	A	30/60max.[100-240V]		
Leakage current	mA	0.75/0.75max.[AC.100V(DENAN)/240V(UL, IEC)]		
Power factor		0.99/0.95typ.[100-240V]		
Efficiency	%	75/77typ. [100-240V]	78/80typ. [100-240V]	79/81typ. [100-240V]
Output characteristics				
Output voltage Edc	V	5	12	15
Voltage variable range Edc	V	4.5 to 5.5	10.8 to 13.2	13.5 to 16.5
Maximum output current	A	15	6.3	5.0
Overvoltage threshold Edc	V	5.75 to 6.9	13.8 to 16.8	17.2 to 21
Overcurrent threshold	A	15.8min.	6.6min.	5.2min.
Voltage stability	Source effect	% 0.4max.[Within the input voltage range]		
	Load effect	% 0.8max.[0 to 100% load]		
	Temperature effect	% 1max.[Ambient temperature: -10 to +60°C]		
	Drift(Time effect)	% 0.4max.[25°C, input and output ratings, after input voltage ON for 30min to 8h]		
	Recovery	% ±4max.[50 to 100% sudden load change]		
Ripple Ep-p	mV	80	120	120
Ripple noise Ep-p	mV	120	150	150
Start up time	ms	500max.(400typ.)/250max.(200typ.)[AC.100/240V]		
Hold up time	ms	20typ.[100-240V]		
Auxiliary functions				
Indicator display		No		
Overvoltage protection		Voltage shut-down type(Latch).		
Overcurrent protection		Rectangular type, automatic recovery.		
Remote ON-OFF		No		
Remote sensing		No		
Standards				
Safety standards		UL60950-1, CSA C22.2 No.60950-1(C-UL), EN60950-1(TÜV) approved.		
Noise terminal voltage		FCC-B, VCCI-B, EN55011-B, EN55022-B meet.		
Input harmonics current requirement		EN61000-3-2		
CE marking		Planned compliance.		
Constructions				
External dimensions	mm	32×55×222[H×W×L]		
Weight	g	290max.		
Mounting method		Can be attached to 1 side.		
Case material		CEM3		

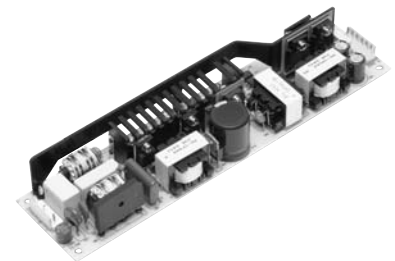

# JBW75W Type

## SHAPES AND DIMENSIONS

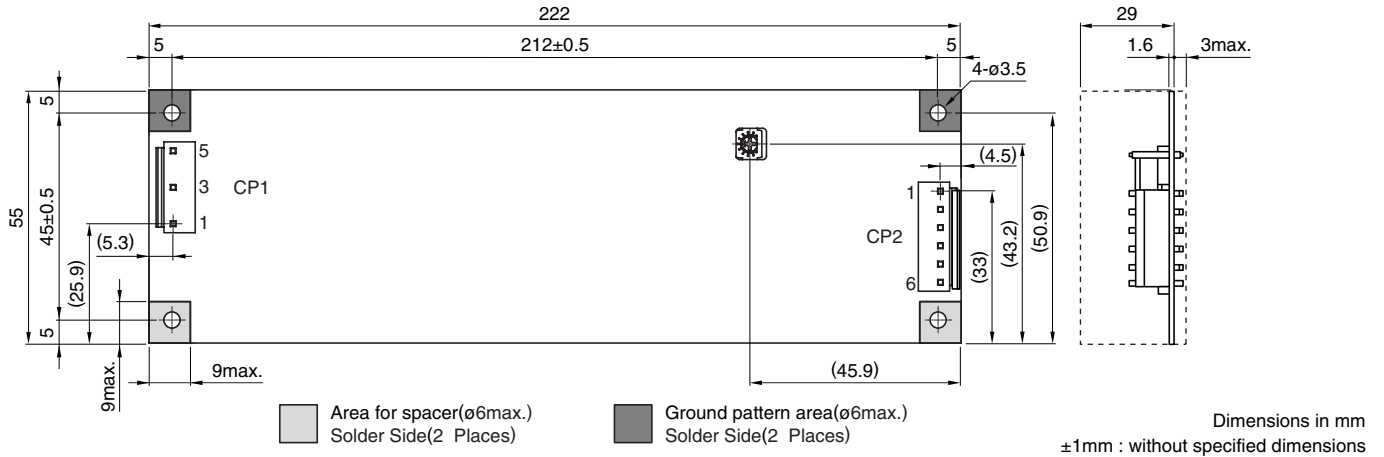

## TERMINAL DESIGNATION

CP1

P1	L
P3	N
P5	⊥

· Japan Solderless Terminal Co., Ltd.  
VH Series B3P5-VH-B



CP2

P1	
P2	-
P3	
P4	
P5	+
P6	

· Japan Solderless Terminal Co., Ltd.  
VH Series B6P-VH-B

Connector made by	Power supply side connector	Cable Side	
		Housing	Terminal
Japan Solderless Terminal Co., Ltd.			
Input Connector(CP1)VH Series	B3P5-VH-B	VHR-5N	SVH-21T-P1.1
Output Connector(CP2)VH Series	B6P-VH-B	VHR-6N	SVH-21T-P1.1

Option	Part No.
Set	4EU20G085

## JBW100W Type

### SPECIFICATIONS AND STANDARDS

Part No.		JBW05-20R	JBW12-8R5	JBW15-6R7	JBW24-4R3
Rated output voltage and current		5V • 20A	12V • 8.5A	15V • 6.7A	24V • 4.3A
Maximum output power	W	100	102	100.5	103.2
Input conditions					
Input voltage Eac/Edc	V	85 to 265[Rating: 100-240]/120 to 370			
Input frequency	Hz	47 to 66			
Input current	A	1.8/1.0max.[100-240V]			
Fuse rating	A	5			
Surge current	A	30/60max.[100-240V]			
Leakage current	mA	0.75/0.75max.[AC.100V(DENAN)/240V(UL, IEC)]			
Power factor		0.99/0.95typ.[100-240V]			
Efficiency	%	78/80typ. [100-240V]	80/82typ. [100-240V]	80/82typ. [100-240V]	82/85typ. [100-240V]
Output characteristics					
Output voltage Edc	V	5	12	15	24
Voltage variable range Edc	V	±10%	±10%	±10%	±10%
Maximum output current	A	20	8.5	6.7	4.3(Peak5)
Overvoltage threshold Edc	V	5.75 to 6.9	13.8 to 16.8	17.2 to 21	27.6 to 33.6
Overcurrent threshold	A	21.0min.	10.6min.	8.38min.	5.38min.
Voltage stability	Source effect	% 0.4max.[Within the input voltage range]			
	Load effect	% 0.8max.[0 to 100% load]			
	Temperature effect	% 1max.[Ambient temperature: -10 to +60°C]			
	Drift(Time effect)	% 0.4max.[25°C, input and output ratings, after input voltage ON for 30min to 8h]			
	Recovery	% ±4max.[50 to 100% sudden load change]			
Ripple Ep-p	mV	80	120	120	120
Ripple noise Ep-p	mV	120	150	150	150
Start up time	ms	500max.(400typ.)/500max.(300typ.)[AC.100/240V]			
Hold up time	ms	20typ.[100-240V]			
Auxiliary functions					
Indicator display		No			
Overvoltage protection		Voltage shut-down type(Latch).			
Overcurrent protection		Rectangular type, automatic recovery.			
Remote ON-OFF		No			
Remote sensing		No			
Standards					
Safety standards		UL60950-1, CSA C22.2 No.60950-1(C-UL), EN60950-1(TÜV) approved.			
Noise terminal voltage		FCC-B, VCCI-B, EN55011-B, EN55022-B meet.			
Input harmonics current requirement		EN61000-3-2			
CE marking		Planned compliance.			
Constructions					
External dimensions	mm	35×62×222[H×W×L]			
Weight	g	400max.			
Mounting method		Can be attached to 1 side.			
Case material		FR4			

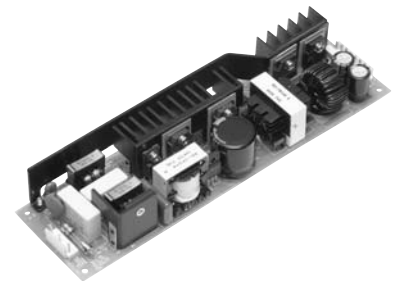

# JBW100W Type

## SHAPES AND DIMENSIONS

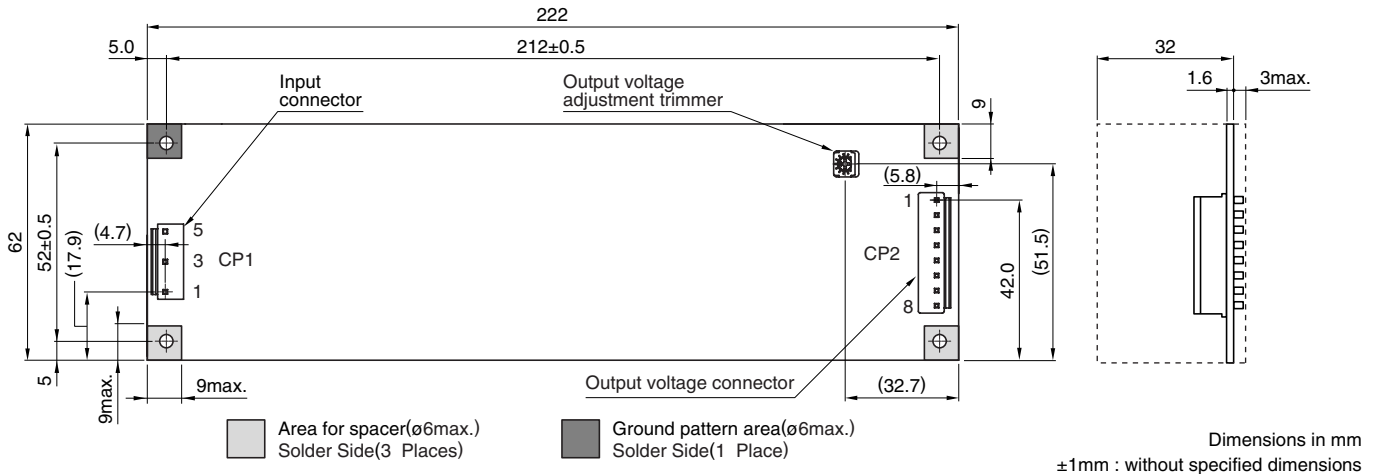

## TERMINAL DESIGNATION

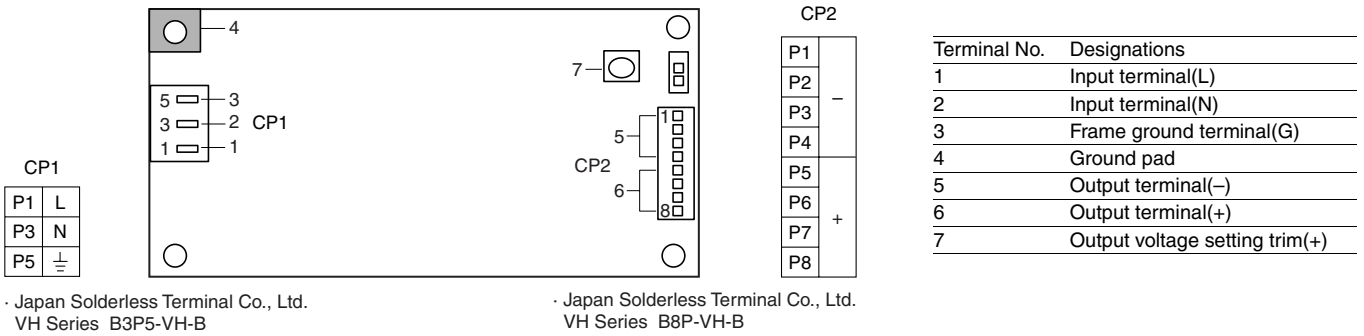

Connector made by	Power supply side connector	Cable Side	
		Housing	Terminal
Japan Solderless Terminal Co., Ltd.			
Input Connector(CP1)VH Series	B3P5-VH-B	VHR-5N	SVH-21T-P1.1
Output Connector(CP2)VH Series	B8P-VH-B	VHR-8N	SVH-21T-P1.1

Option	Part No.
Set	4EU20G056

• All specifications are subject to change without notice.

## JBW150W Type

### SPECIFICATIONS AND STANDARDS

Part No.		JBW05-30R	JBW12-12R	JBW15-10R	JBW24-6R3	JBW48-3R2
Rated output voltage and current*		5V • 30A	12V • 12A	15V • 10A	24V • 6.3A	48V • 3.2A
Maximum output power	W	150	150	150	151.2	153.6
Input conditions						
Input voltage Eac/Edc	V	85 to 265[Rating: 100-240]/120 to 370				
Input frequency	Hz	47 to 66				
Input current	A	2.7/1.5max.[100-240V]				
Surge current	A	30/60max.[100-240V]				
Leakage current	mA	0.75/0.75max.[AC.100V(DENAN)/240V(UL, IEC)]				
Power factor		0.99/0.95typ.[100-240V]				
Efficiency	%	78/80typ. [100-240V]	81/83typ. [100-240V]	81/83typ. [100-240V]	82/84typ. [100-240V]	82/84typ. [100-240V]
Output characteristics						
Output voltage Edc	V	5	12	15	24	48
Voltage variable range Edc	V	4.5 to 5.5	10.8 to 13.2	13.5 to 16.5	21.6 to 26.4	43.2 to 52.8
Maximum output current	A	30	12.5	10	6.3(Peak7.5)	3.2
Oversvoltage threshold Edc	V	5.75 to 6.9	13.8 to 16.8	17.2 to 21	27.6 to 33.6	55.2 to 67.2
Overcurrent threshold	A	31.5min.	15.7min.	12.5min.	7.87min.	3.36min.
Voltage stability	Source effect	% 0.4max.[Within the input voltage range]				
	Load effect	% 0.8max.[0 to 100% load]				
	Temperature effect	% 1max.[Ambient temperature: -10 to +60°C]				
	Drift(Time effect)	% 0.4max.[25°C, input and output ratings, after input voltage ON for 30min to 8h]				
Recovery	% ±4max.[50 to 100% sudden load change]					
Ripple Ep-p	mV	80max.	120max.	120max.	120max.	150max.
Ripple noise Ep-p	mV	120max.	150max.	150max.	150max.	350max.
Start up time	ms	500max.(400typ.)/500max.(300typ.)[AC.100/240V]				
Hold up time	ms	25/35typ.[AC.100/240V]				
Auxiliary functions						
Indicator display		No				
Oversvoltage protection		Voltage shut-down type(Latch).				
Overcurrent protection		Rectangular type, automatic recovery.				
Remote ON-OFF		No				
Remote sensing		No				
Standards						
Safety standards		UL60950-1, CSA C22.2 No.60950-1(C-UL), EN60950-1(TÜV) approved.				
Noise terminal voltage		FCC-B, VCCI-B, EN55011-B, EN55022-B meet.				
Input harmonics current requirement		EN61000-3-2				
CE marking		Meet.				
Constructions						
External dimensions	mm	40×75×222[H×W×L]				
Weight	g	550max.				
Mounting method		Can be attached to 1 side.				
Case metal		FR4				

\* Current rating(maximum output current) is determined for -10 to +40°C. Derating is required when used outside this temperature range.

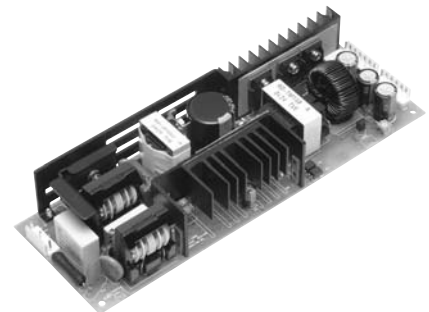

# JBW150W Type

## SHAPES AND DIMENSIONS

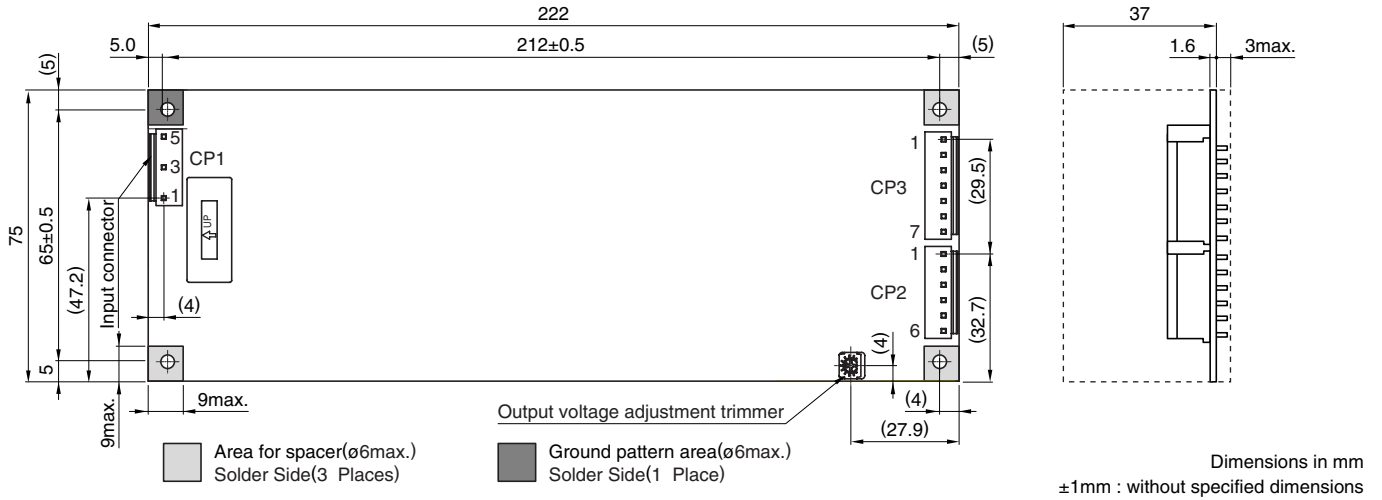

## TERMINAL DESIGNATION

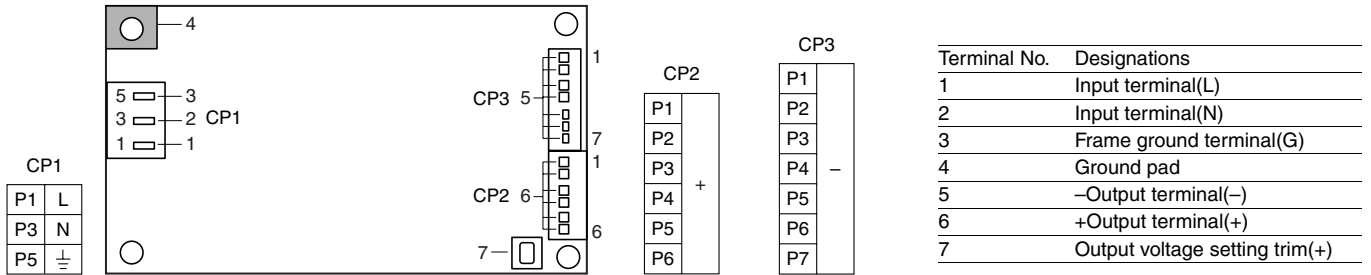

· Japan Solderless Terminal Co., Ltd. VH Series B3P5-VH-B

· Japan Solderless Terminal Co., Ltd. VH Series B6P-VH-B

· Japan Solderless Terminal Co., Ltd. VH Series B7P-VH-B

Connector made by	Power supply side connector	Cable Side	
		Housing	Terminal
Japan Solderless Terminal Co., Ltd.			
Input Connector(CP1)VH Series	B3P5-VH-B	VHR-5N	SVH-21T-P1.1
Output Connector(CP2)VH Series	B6P-VH-B	VHR-6N	SVH-21T-P1.1
Output Connector(CP3)VH Series	B7P-VH-B	VHR-7N	SVH-21T-P1.1

Option	Part No.
Set	4EU00G062

## Characteristics, Functions, and Applications

### BLOCK DIAGRAMS

#### JBW10W/15W/30W TYPES

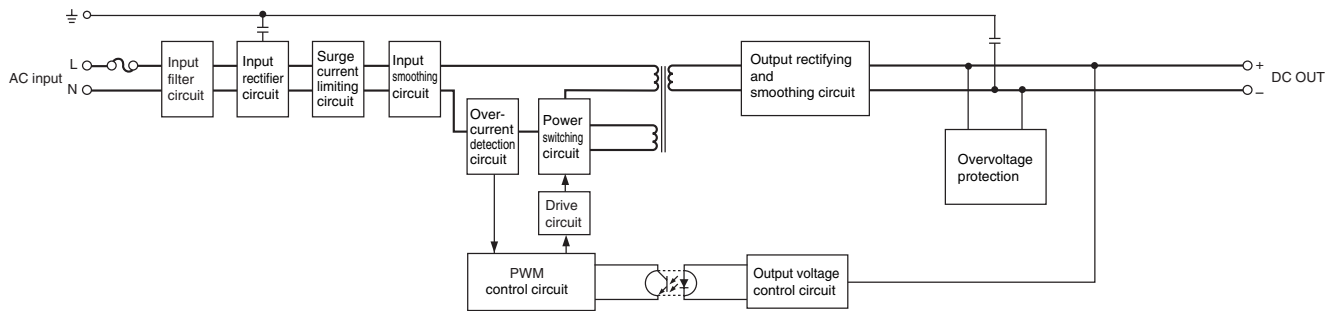

#### JBW50W TYPE

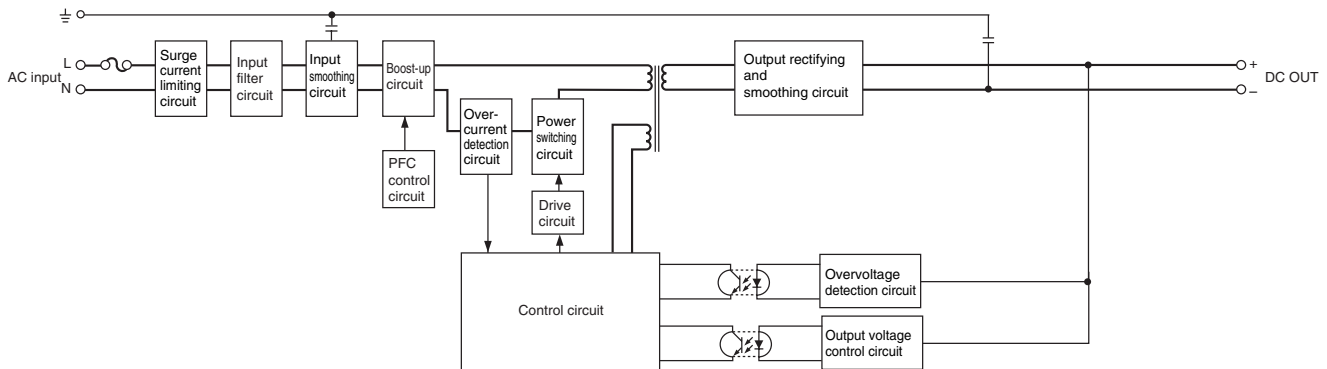

### COMMON SPECIFICATIONS

Temperature and humidity		
	Operating(°C)	-10 to +60
Temperature range	Operating available(°C)	-20 to -10
	Storage(°C)	-30 to +75
Humidity range	Operating(%)RH	10 to 90[Maximum wet-bulb temperature: 35°C, without dewing]
	Storage(%)RH	
Vibration and shock		
Vibration	5 to 10Hz	All amplitude 10mm[3 directions, each 1h]
	10 to 200Hz	Acceleration 19.6m/s <sup>2</sup> (2G)[3 directions, each 1h]
Shock	Acceleration	10 to 50W: 588m/s <sup>2</sup> (60G)[3 directions, each 3 times]/75 to 150W: 588m/s <sup>2</sup> (60G)[Sine wave]
	Pulse duration	11±5ms
Withstand voltage and insulation resistance		
Withstand voltage	Input terminal to ground terminal(G)	Eac: 2kV, 1min[Normal temperature, normal humidity, cutout current 10mA]
	Input terminal to output terminal	Eac: 3kV, 1min[Normal temperature, normal humidity, cutout current 10mA]
	Output terminal to ground terminal(G)	Eac: 500V, 1min[Normal temperature, normal humidity, cutout current 10mA]
	Input terminal to ground terminal(G)	
Insulation resistance	Input terminal to output terminal	Eac: 500V, 100MΩ min.[Normal temperature, normal humidity]
	Output terminal to ground terminal(G)	



# Characteristics, Functions, and Applications

## 10 to 50W TYPES

### OUTPUT POWER-AMBIENT TEMPERATURE(DERATINGS)

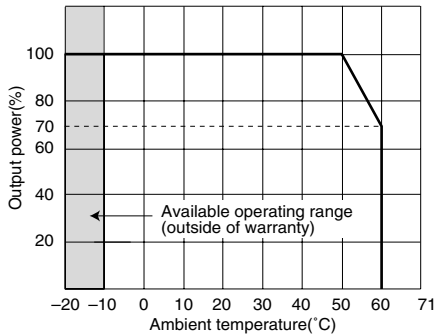

## INSTALLATIONS

- Mounting the power supply at the four corners with metal spacers (2 corners for 10W models).
- Maintain a min. 4mm clearance distance in order to satisfy insulation and high voltage safety requirements.
- Lay an insulating sheet under the power supply in case a min. 8mm installation space cannot be secured between the PC board and the housing.
- Provide a min. 4mm distance between heat sink or component surface and surrounding objects in order to cause a thermal convection.
- Since components are mounted on the back (solder) side of the product, sufficient care should be taken when handling the power supply to protect the PC board from shock, vibration, torsion, etc. which can result in damage caused by cracked chip components.

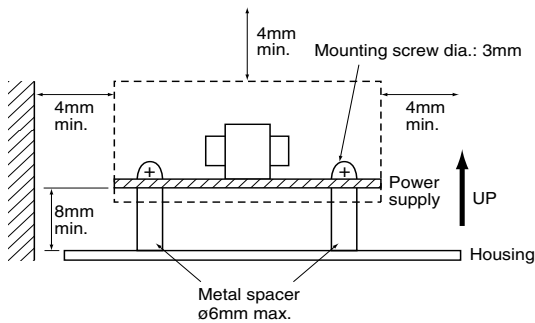

To install the power supply in a device, apply the standard installation direction (A) or (B). In case of an installation in other directions, please contact TDK.

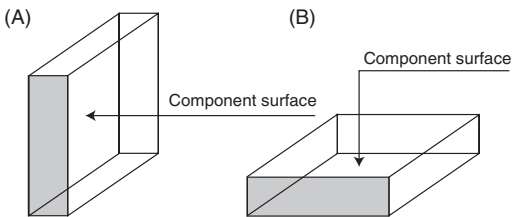

The shaded portion indicates a side in which an output connector is arranged.

## 75 to 150W TYPES

### OUTPUT POWER-AMBIENT TEMPERATURE(DERATINGS)

#### 75, 100W TYPES

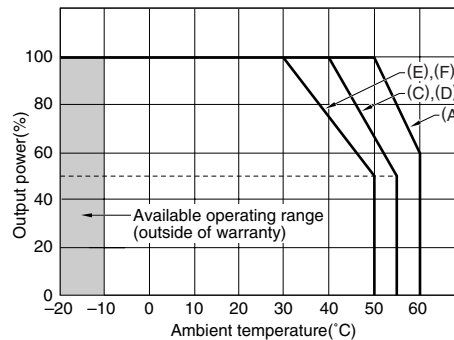

#### 150W TYPE

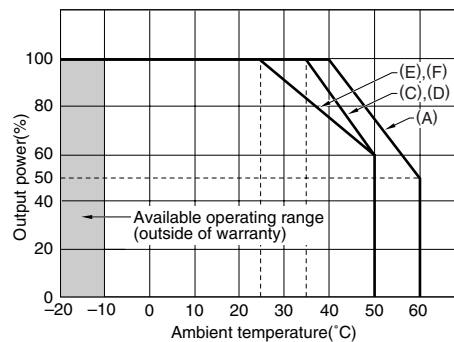

## INSTALLATION DIRECTION

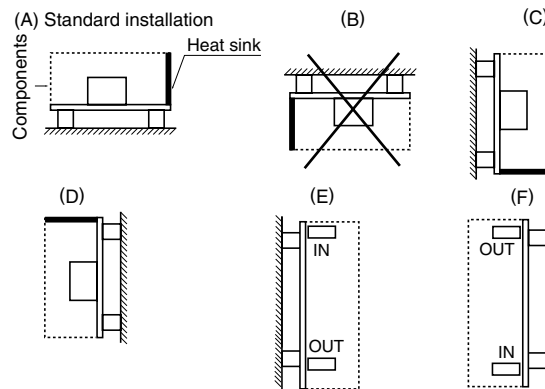

There are installation directions (B) to (F) as shown below in addition to the standard installation direction (A) for mounting the power supply on an apparatus. The installation (B), however, is inhibited because it will cause heat to be trapped inside the power supply.

Derating of the output voltage and the ambient temperature for the installation directions (C) to (F) are not the same as for the direction (A). Please consult us if you need.

## Characteristics, Functions, and Applications

### RIPPLE NOISE MEASUREMENT CONDITIONS

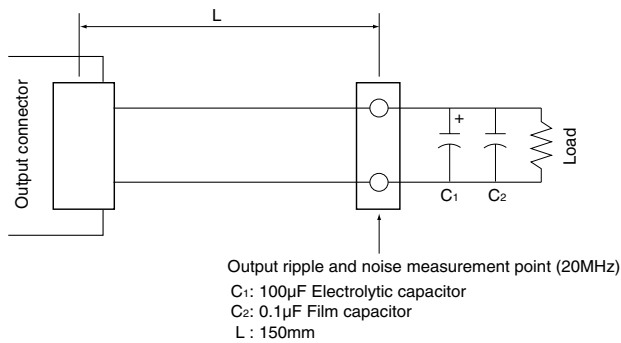

### SERIES OPERATION (TO INCREASE OUTPUT VOLTAGE OR TO OBTAIN SEPARATE $\pm$ OUTPUT)

When the output voltage of a single power supply is insufficient, several power supplies can be connected in series in order to obtain a higher voltage or separate  $\pm$  outputs.

If power supplies A and B in the illustration below are 5V each, a 10V output can be obtained in this connection. It should be noted that, however, the output current is limited to the lower rated current value of the power supplies A and B. There is no problem if the voltages of A and B are different from each other.

D1 and D2 in the illustration designate diodes for preventing reverse voltage application. They are provided for preventing internal components of the power supply having the lower rated voltage from being damaged by an applied reverse voltage caused by a short circuit in the load or the like.

Use diodes which meet the following requirements:

Reverse withstanding voltage: Over twice that of the combined output voltage

Forward current: Over twice that of the output current

Forward voltage drop: As small as possible  
 (e.g. Schottkey diode, etc.)

### SERIES CONNECTION FOR INCREASING OUTPUT VOLTAGE

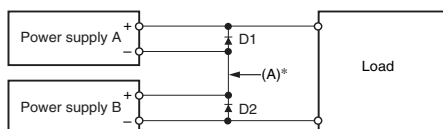

\* For obtaining separate  $\pm$  outputs, (A) should be zero voltage.

### INSULATION AND WITHSTAND VOLTAGE TESTS

The insulation and withstand voltage tests may cause deterioration. Care must be taken for execution of the tests. The potential must be equal among input, output, and FG (frame ground) terminals. It is preferable to use testers that gently start up at the test-ON and automatically discharge charged energy at the test-OFF. Manual discharging after the tests should be through a resistor around 100k $\Omega$  to 1M $\Omega$  (Do not perform discharging at low impedance. It may cause deterioration.)

In any case, take full countermeasures for electric-shock prevention.

### OTHER CONDITIONS

- Unless conditions are otherwise specified in the specifications or standards, 25°C and rated input-output should be applied.

# Characteristics, Functions, and Applications

## JBW10W TYPE TYPICAL CHARACTERISTICS: JBW05-2R0

### AC.100V TYPE: INPUT CURRENT

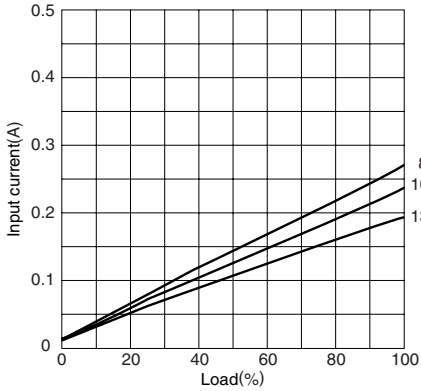

### AC.200V TYPE: INPUT CURRENT

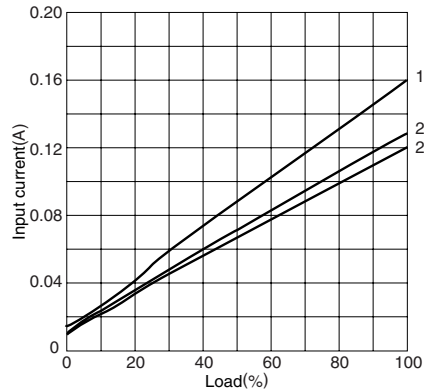

### AC.100V TYPE: EFFICIENCY

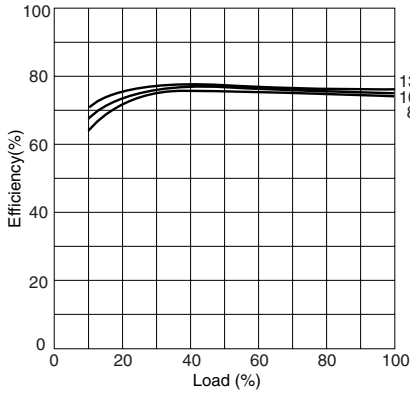

### AC.200V TYPE: EFFICIENCY

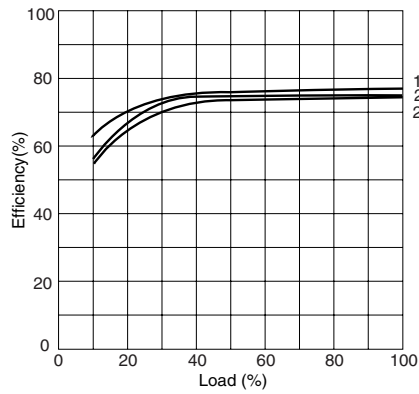

### AC.100V TYPE: POWER FACTOR

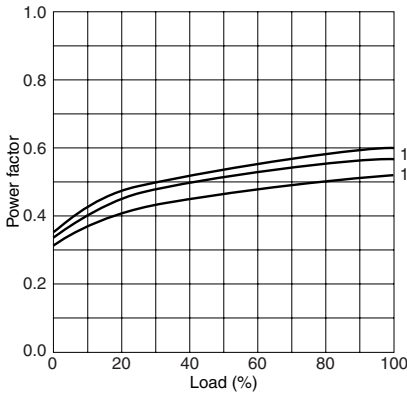

### AC.200V TYPE: POWER FACTOR

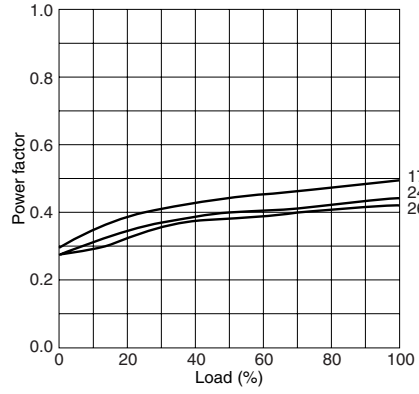

### AC.100V TYPE: SURGE CURRENT

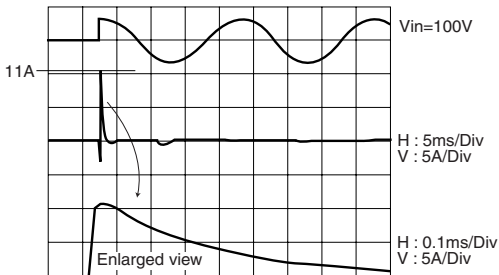

### AC.200V TYPE: SURGE CURRENT

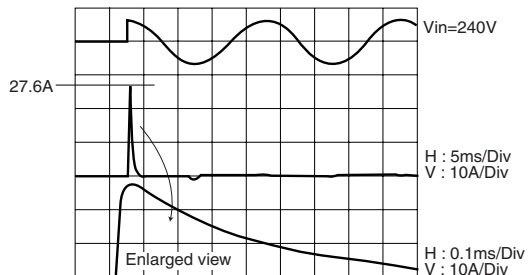

• All specifications are subject to change without notice.

# Characteristics, Functions, and Applications

**JBW10W TYPE TYPICAL CHARACTERISTICS: JBW05-2R0**  
**AC.100/200V TYPE: -20°C START UP CHARACTERISTICS**

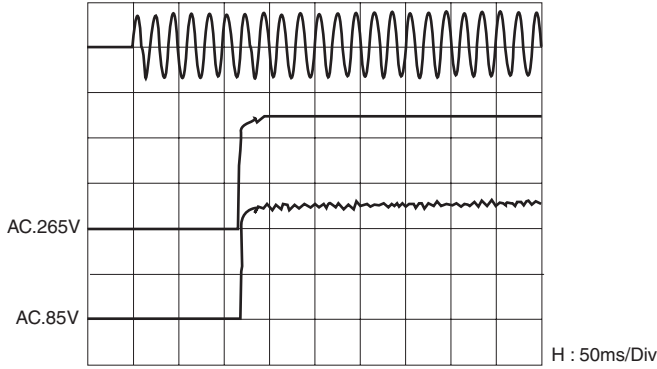

**AC.100/200V TYPE: +60°C START UP CHARACTERISTICS**

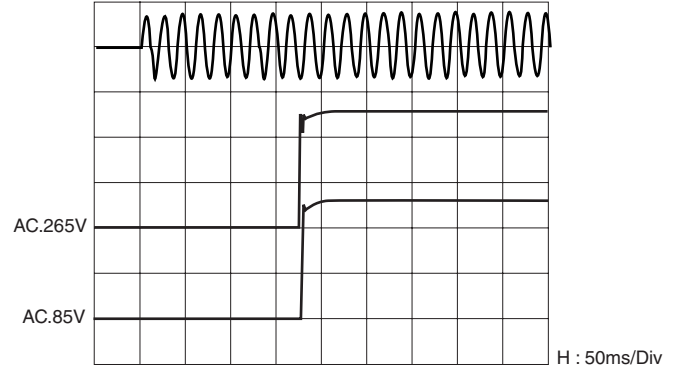

**AC.100/200V TYPE: -20°C HOLD UP CHARACTERISTICS**

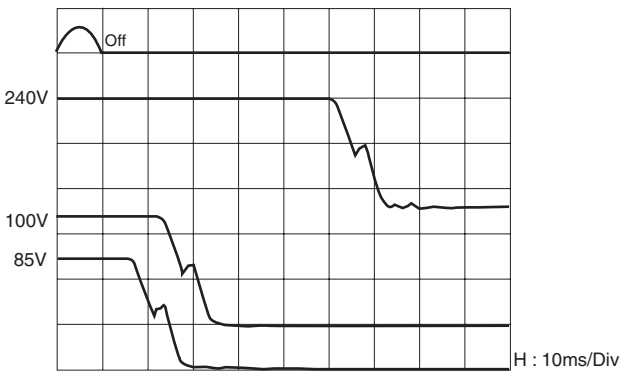

**AC.100/200V TYPE: +60°C HOLD UP CHARACTERISTICS**

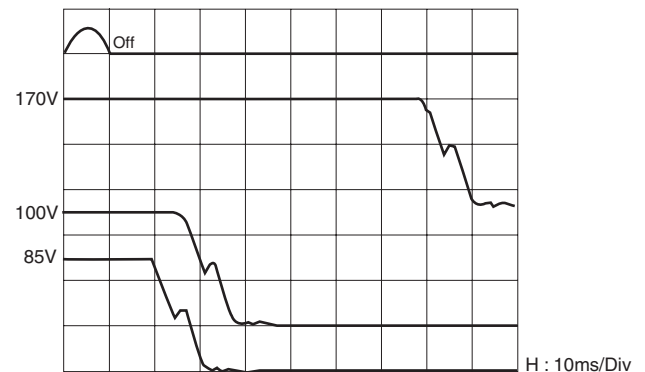

**AC.100V/200V TYPE: -20°C OVERCURRENT CURVE**

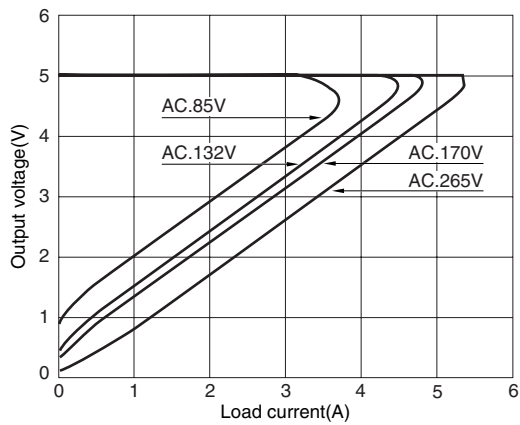

**AC.100V/200V TYPE: +60°C OVERCURRENT CURVE**

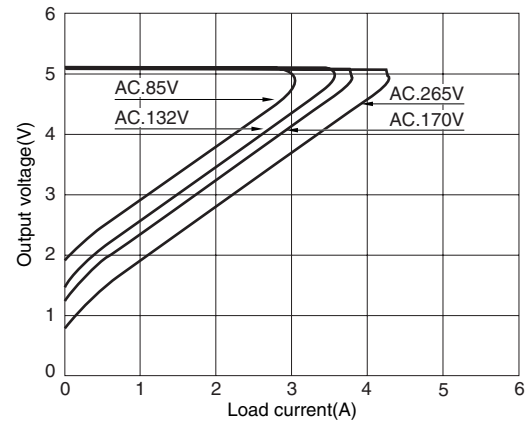

• All specifications are subject to change without notice.

# Characteristics, Functions, and Applications

## JBW10W TYPE TYPICAL CHARACTERISTICS: JBW05-2R0

### AC.100V TYPE: LIFE OF ELECTROLYTIC CAPACITOR

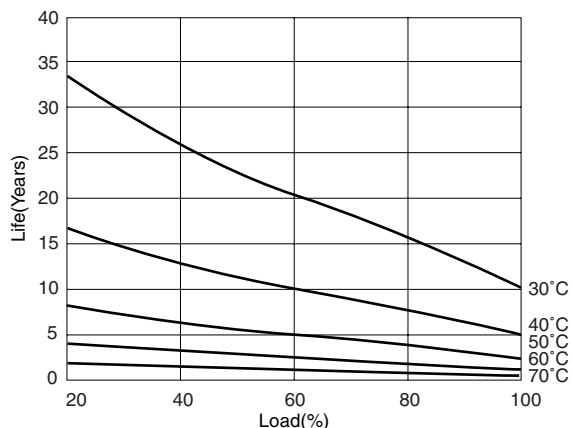

### AC.200V TYPE: LIFE OF ELECTROLYTIC CAPACITOR

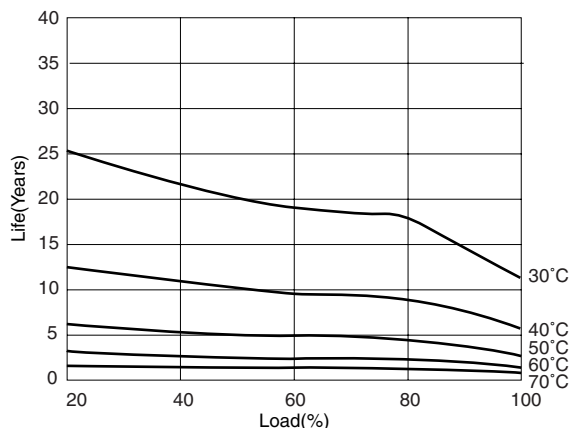

### AC.100V TYPE: HOLD UP TIME

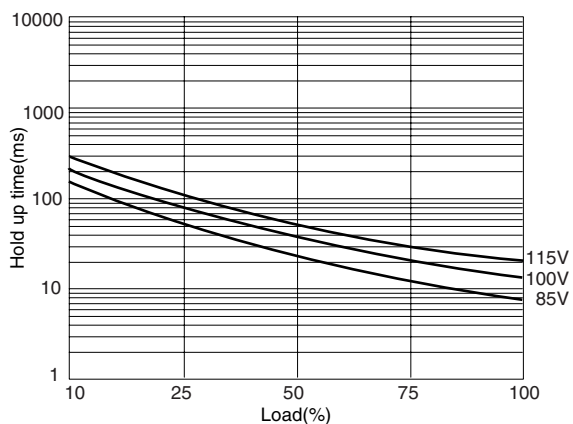

### AC.200V TYPE: HOLD UP TIME

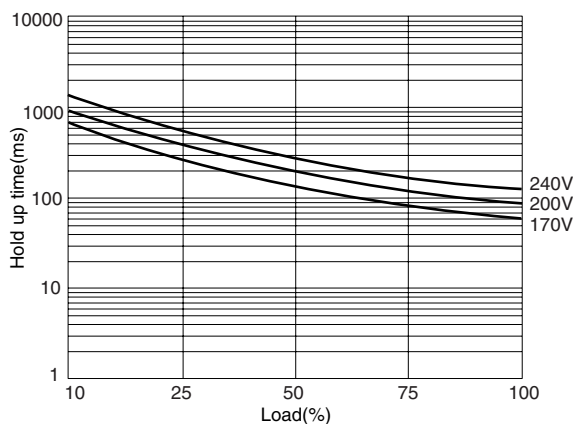

## CONDUCTIVE NOISE EMISSION

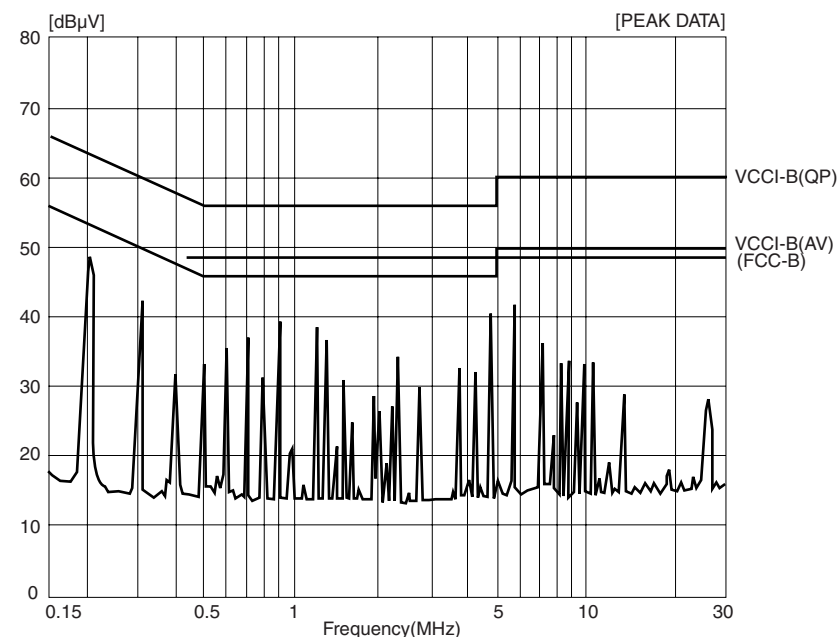

• All specifications are subject to change without notice.

# Characteristics, Functions, and Applications

## JBW15W TYPE TYPICAL CHARACTERISTICS: JBW05-3R0

### AC.100V TYPE: INPUT CURRENT

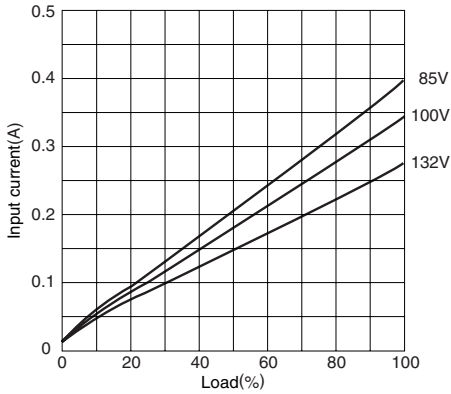

### AC.200V TYPE: INPUT CURRENT

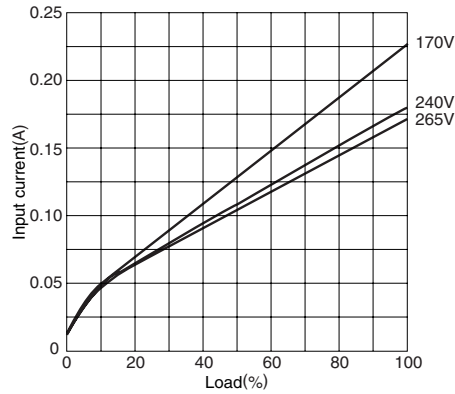

### AC.100V TYPE: EFFICIENCY

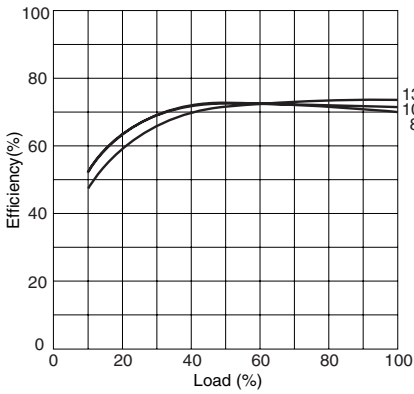

### AC.200V TYPE: EFFICIENCY

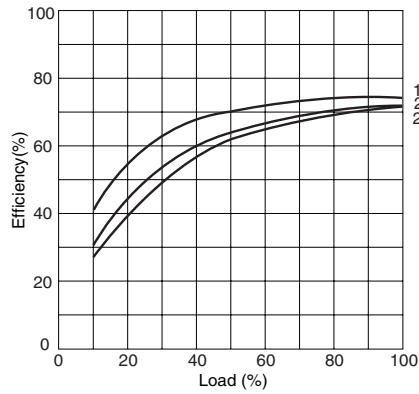

### AC.100V TYPE: POWER FACTOR

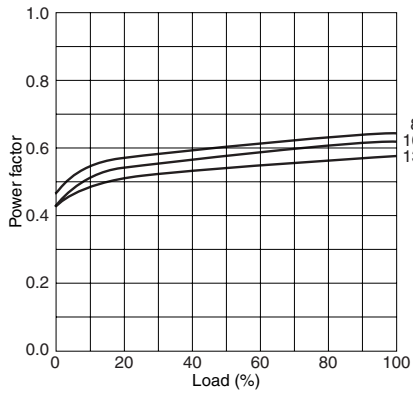

### AC.200V TYPE: POWER FACTOR

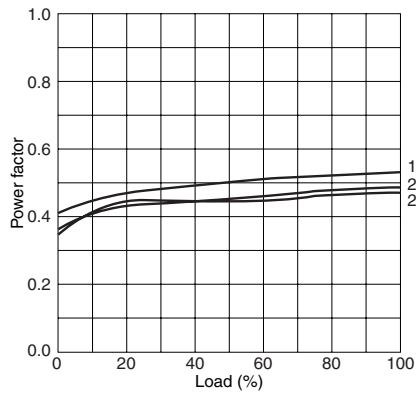

### AC.100V TYPE: SURGE CURRENT

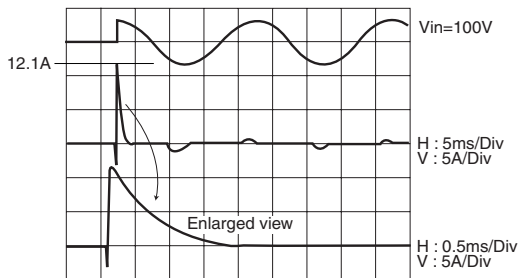

### AC.200V TYPE: SURGE CURRENT

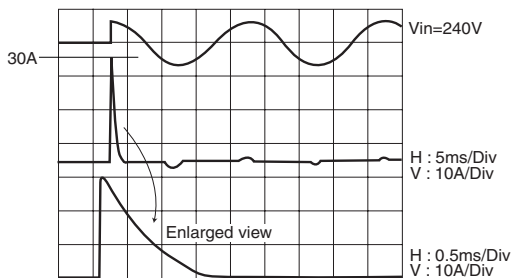

• All specifications are subject to change without notice.

# Characteristics, Functions, and Applications

## JBW15W TYPE TYPICAL CHARACTERISTICS: JBW05-3R0

### AC.100/200V TYPE: -20°C START UP CHARACTERISTICS

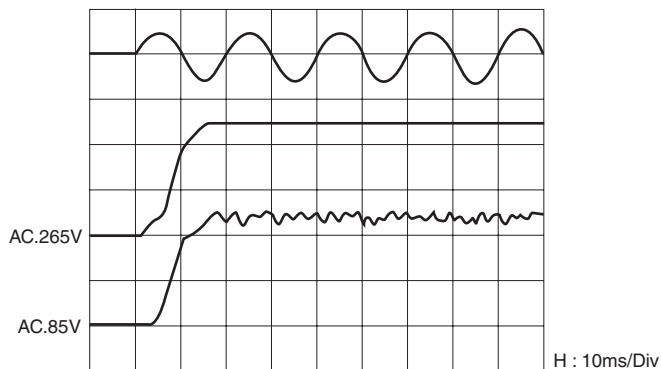

### AC.100/200V TYPE: +60°C START UP CHARACTERISTICS

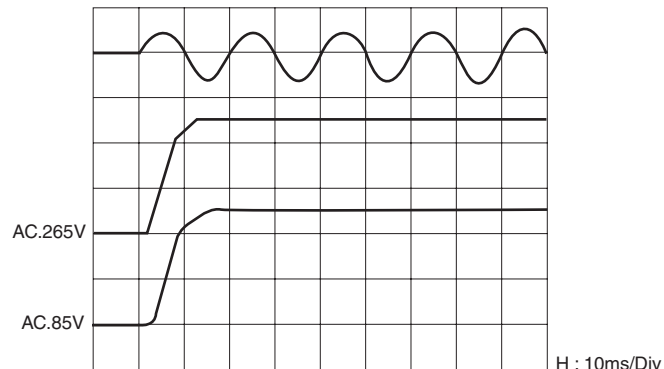

### AC.100/200V TYPE: -20°C HOLD UP CHARACTERISTICS

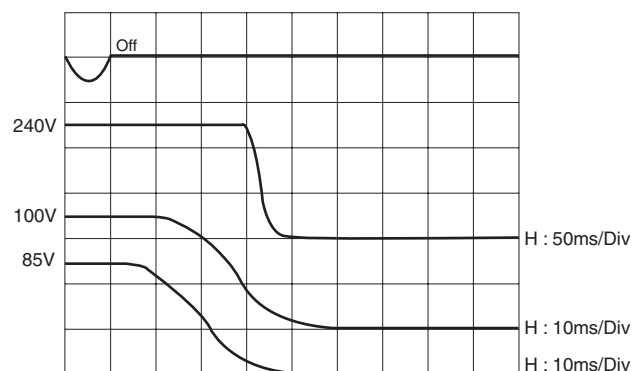

### AC.100/200V TYPE: +60°C HOLD UP CHARACTERISTICS

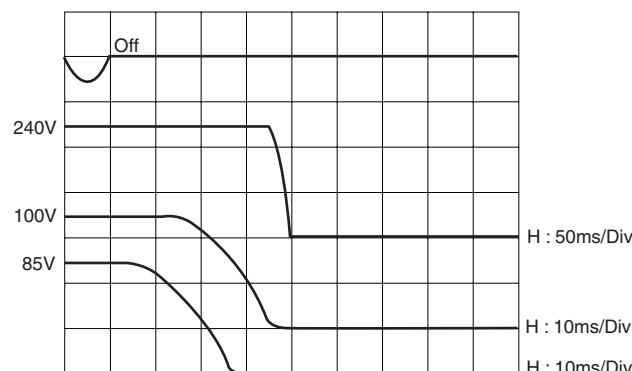

### AC.100V/200V TYPE: -20°C OVERCURRENT CURVE

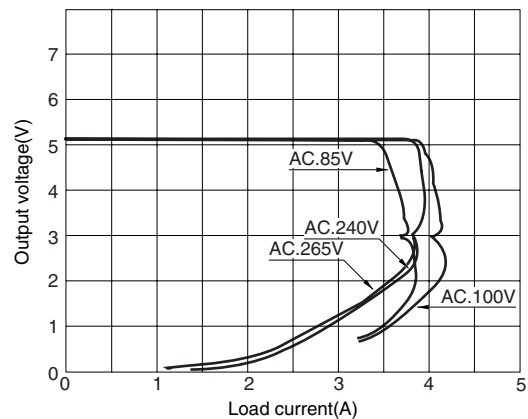

### AC.100V/200V TYPE: +60°C OVERCURRENT CURVE

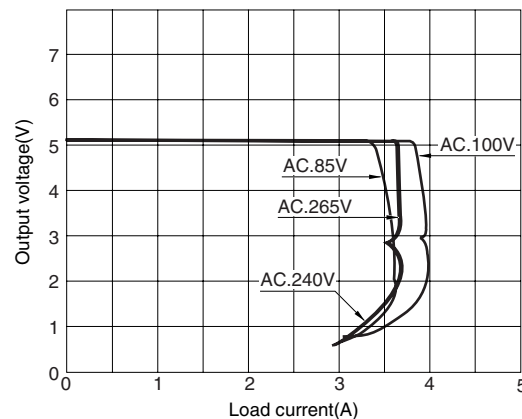

• All specifications are subject to change without notice.

# Characteristics, Functions, and Applications

## JBW15W TYPE TYPICAL CHARACTERISTICS: JBW05-3R0

### AC.100V TYPE: LIFE OF ELECTROLYTIC CAPACITOR

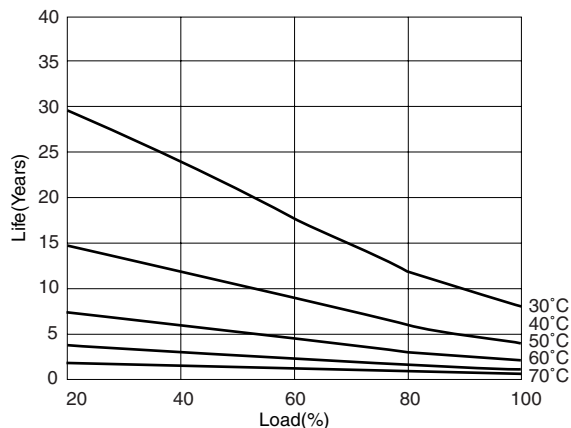

### AC.200V TYPE: LIFE OF ELECTROLYTIC CAPACITOR

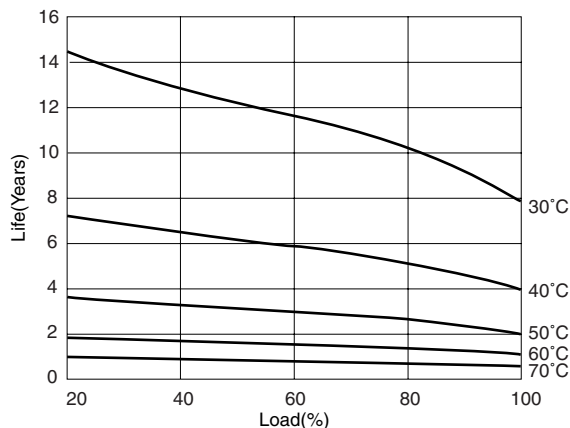

### AC.100V TYPE: HOLD UP TIME

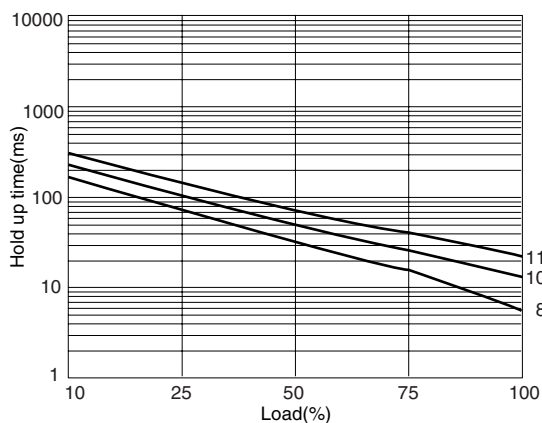

### AC.200V TYPE: HOLD UP TIME

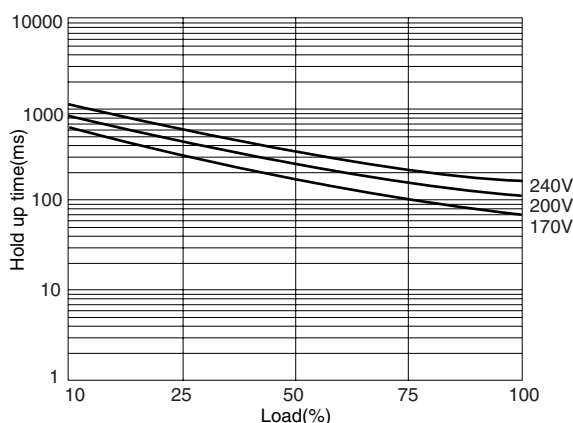

## CONDUCTIVE NOISE EMISSION

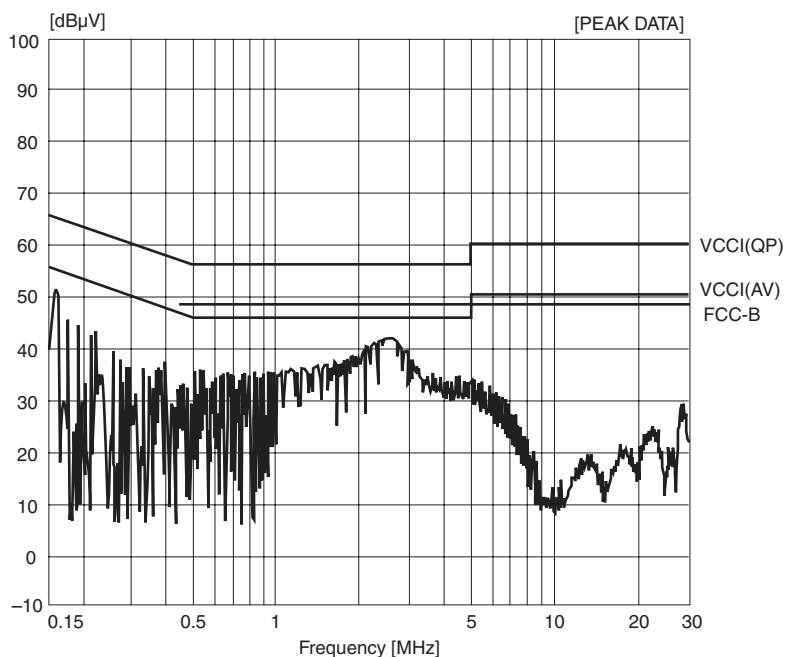

• All specifications are subject to change without notice.



# Characteristics, Functions, and Applications

## JBW30W TYPE TYPICAL CHARACTERISTICS: JBW05-6R0

### AC.100V TYPE: INPUT CURRENT

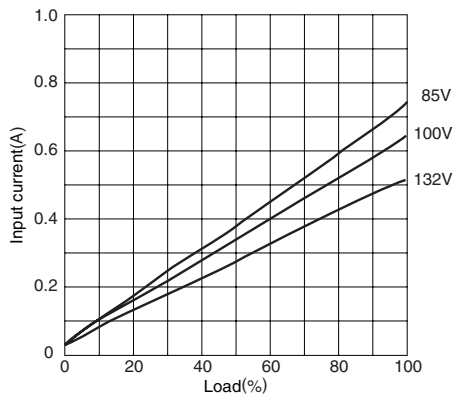

### AC.200V TYPE: INPUT CURRENT

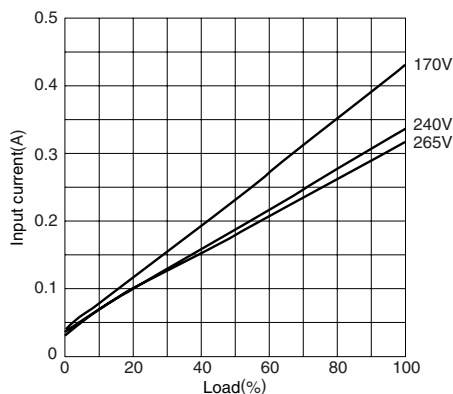

### AC.100V TYPE: EFFICIENCY

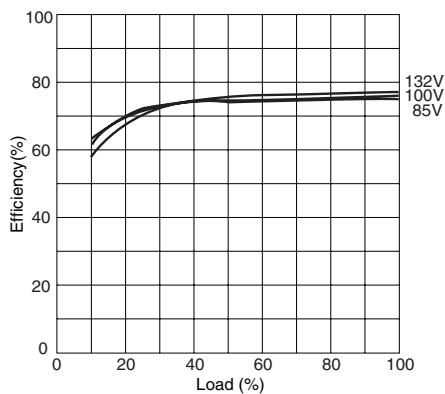

### AC.200V TYPE: EFFICIENCY

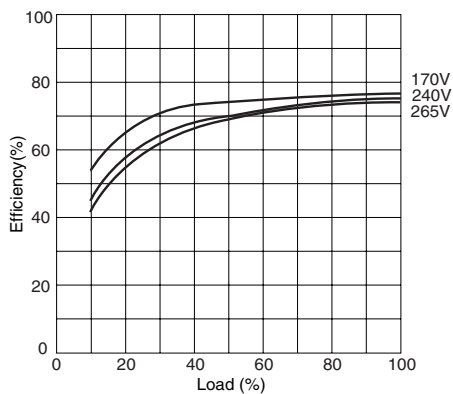

### AC.100V TYPE: POWER FACTOR

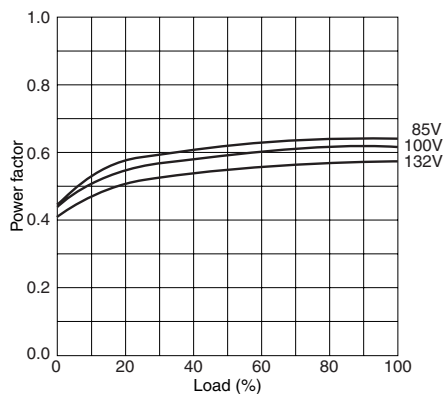

### AC.200V TYPE: POWER FACTOR

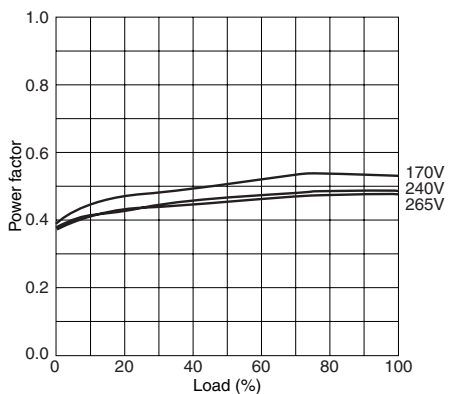

### AC.100V TYPE: SURGE CURRENT

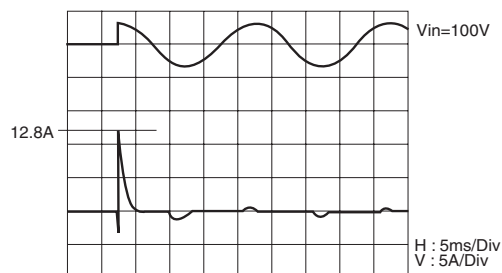

### AC.200V TYPE: SURGE CURRENT

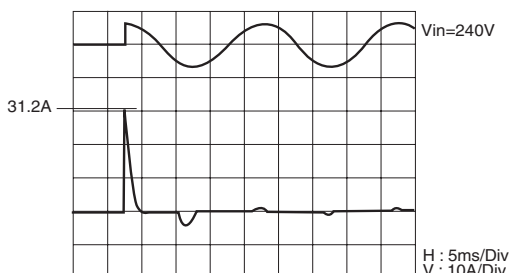

• All specifications are subject to change without notice.

# Characteristics, Functions, and Applications

## JBW30W TYPE TYPICAL CHARACTERISTICS: JBW05-6R0

### AC.100/200V TYPE: -20°C START UP CHARACTERISTICS

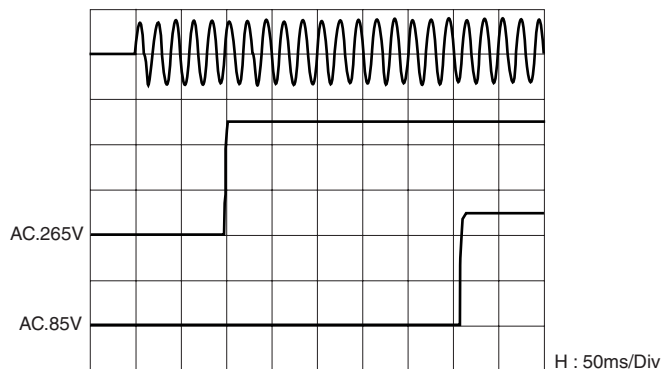

### AC.100/200V TYPE: +60°C START UP CHARACTERISTICS

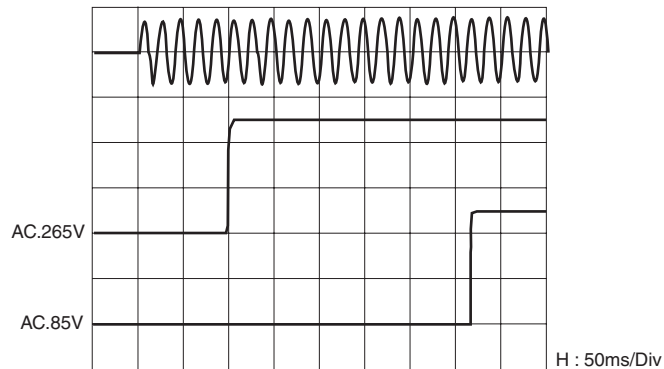

### AC.100/200V TYPE: -20°C HOLD UP CHARACTERISTICS

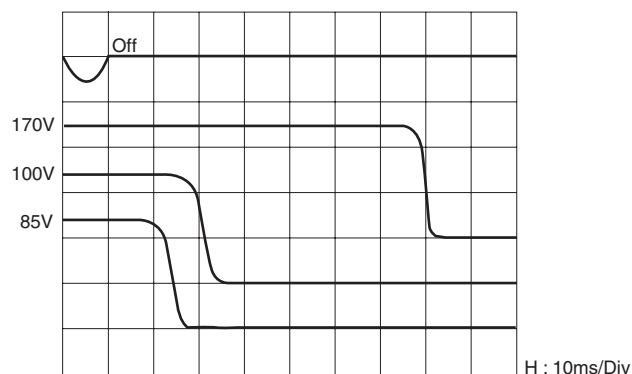

### AC.100/200V TYPE: +60°C HOLD UP CHARACTERISTICS

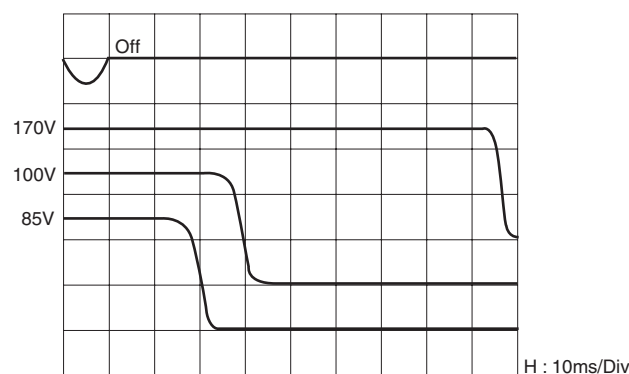

### AC.100V/200V TYPE: -20°C OVERCURRENT CURVE

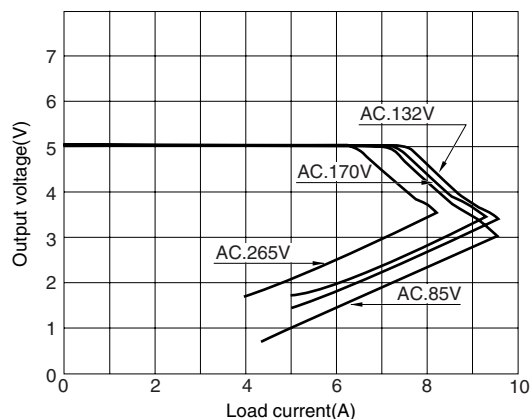

### AC.100V/200V TYPE: +60°C OVERCURRENT CURVE

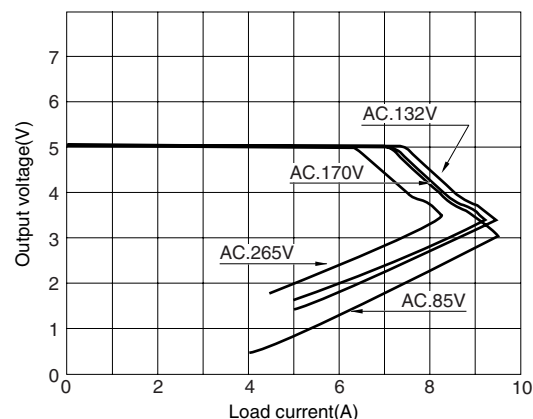

• All specifications are subject to change without notice.

# Characteristics, Functions, and Applications

## JBW30W TYPE TYPICAL CHARACTERISTICS: JBW05-6R0

### AC.100V TYPE: LIFE OF ELECTROLYTIC CAPACITOR

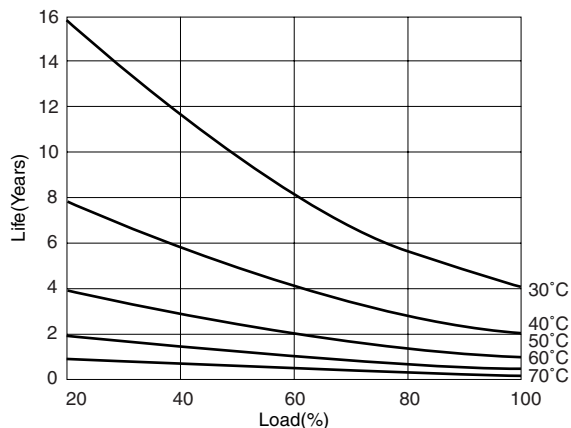

### AC.200V TYPE: LIFE OF ELECTROLYTIC CAPACITOR

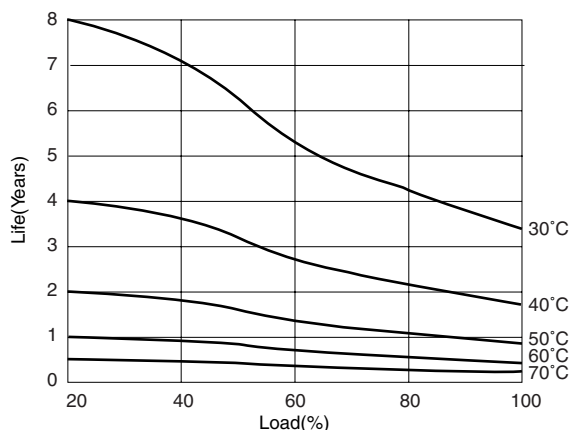

### AC.100V TYPE: HOLD UP TIME

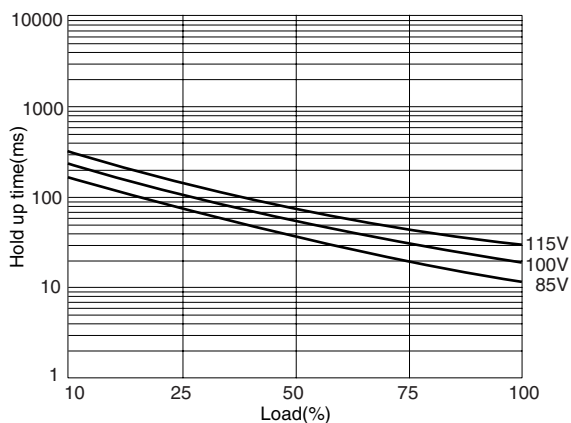

### AC.200V TYPE: HOLD UP TIME

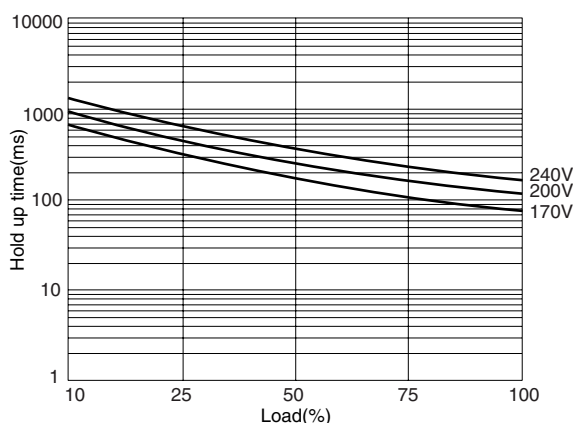

## CONDUCTIVE NOISE EMISSION

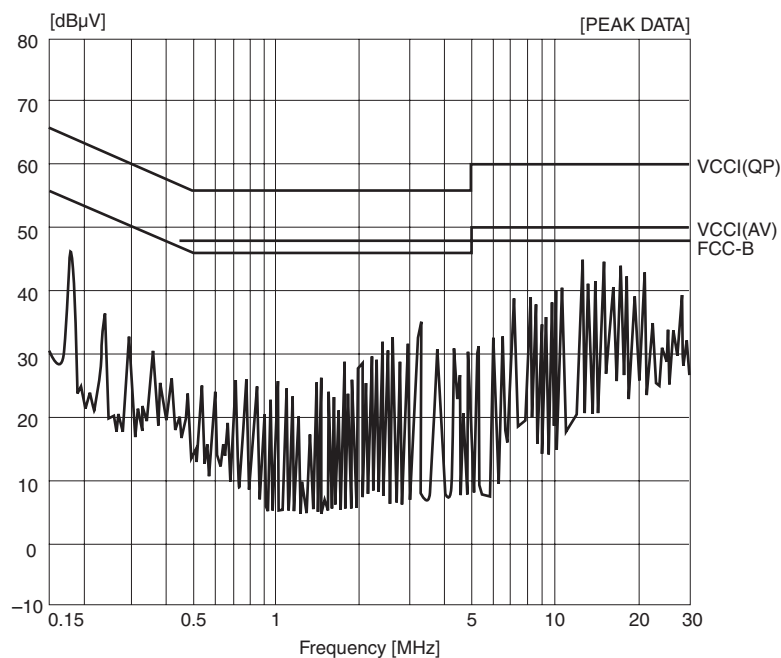

• All specifications are subject to change without notice.

# Characteristics, Functions, and Applications

## JBW50W TYPE TYPICAL CHARACTERISTICS: JBW05-10R

### AC.100V TYPE: INPUT CURRENT

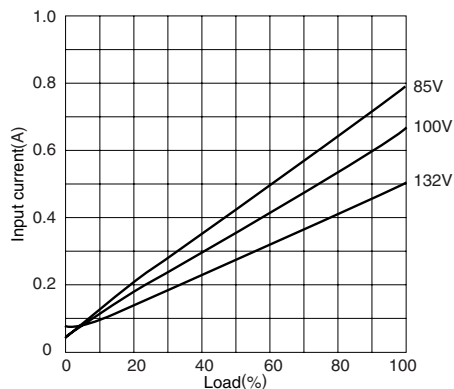

### AC.200V TYPE: INPUT CURRENT

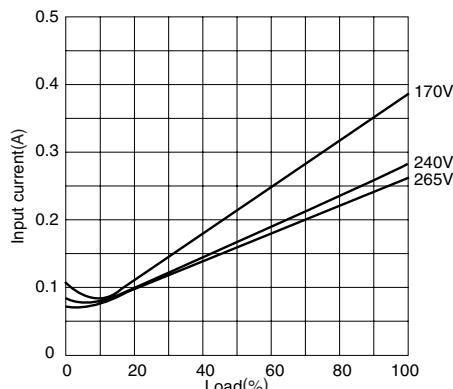

### AC.100V TYPE: EFFICIENCY

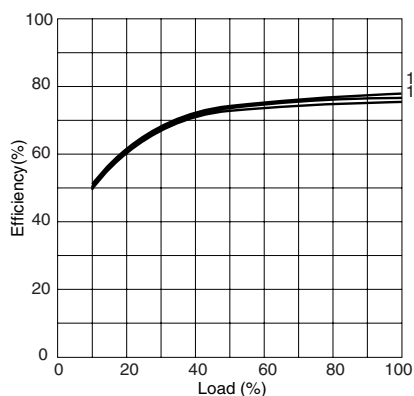

### AC.200V TYPE: EFFICIENCY

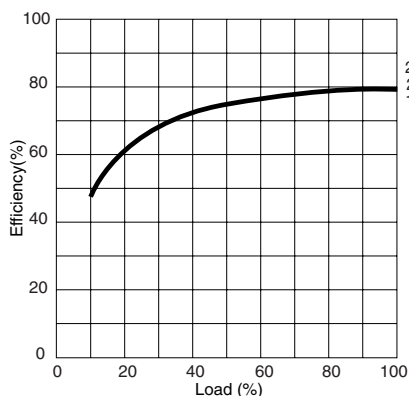

### AC.100V TYPE: POWER FACTOR

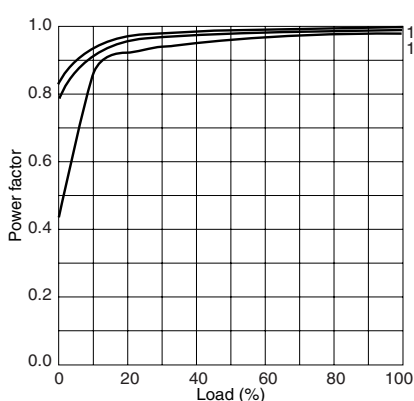

### AC.200V TYPE: POWER FACTOR

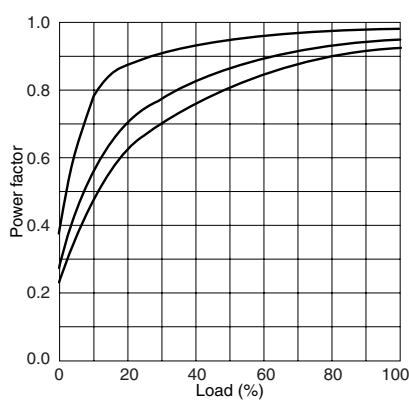

### AC.100V TYPE: SURGE CURRENT

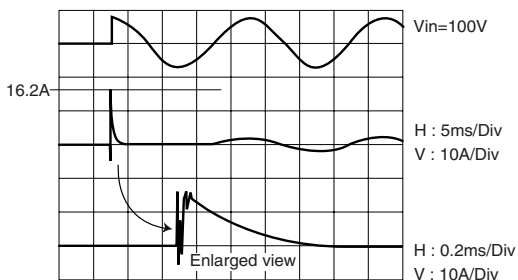

### AC.200V TYPE: SURGE CURRENT

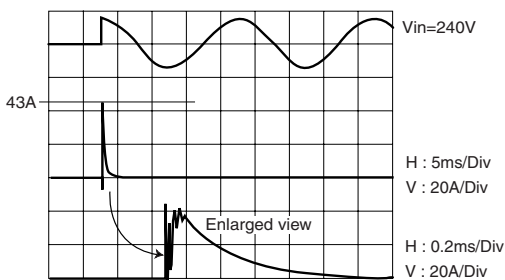

• All specifications are subject to change without notice.

# Characteristics, Functions, and Applications

## JBW50W TYPE TYPICAL CHARACTERISTICS: JBW05-10R AC.100/200V TYPE: -20°C START UP CHARACTERISTICS

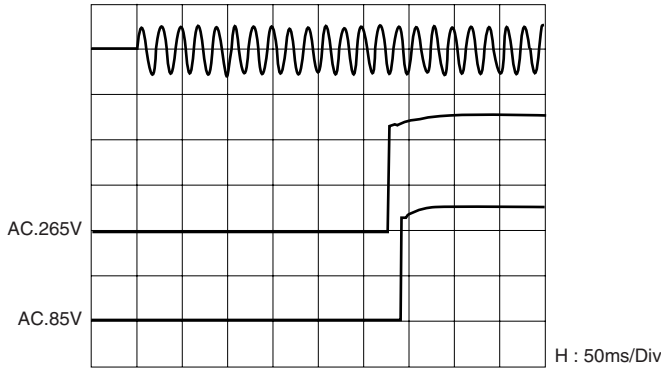

## AC.100/200V TYPE: +60°C START UP CHARACTERISTICS

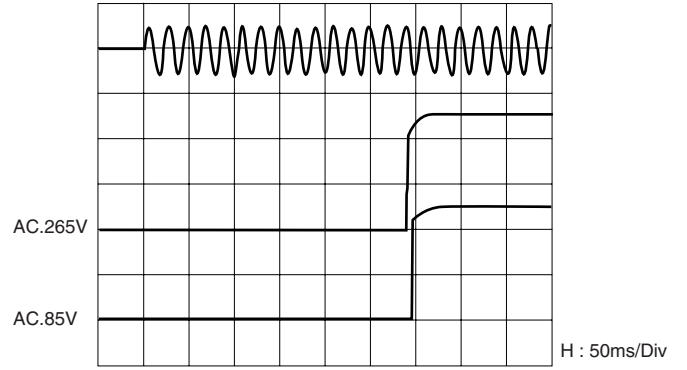

## AC.100/200V TYPE: -20°C HOLD UP CHARACTERISTICS

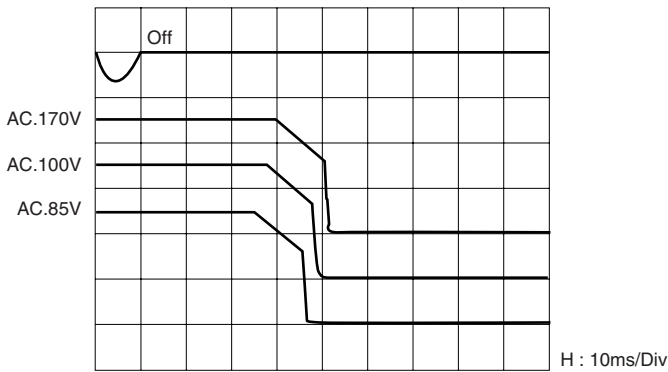

## AC.100/200V TYPE: +60°C HOLD UP CHARACTERISTICS

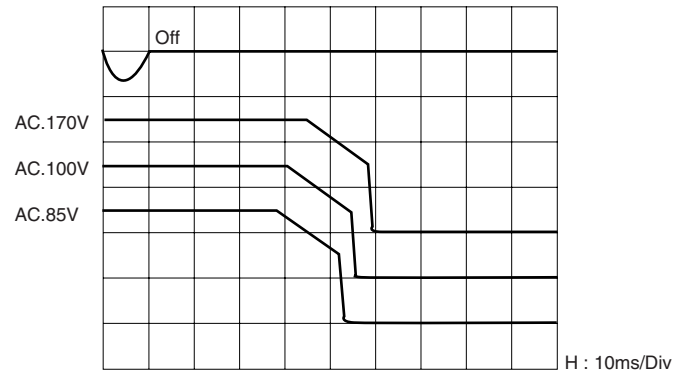

## AC.100V/200V TYPE: -20°C OVERCURRENT CURVE

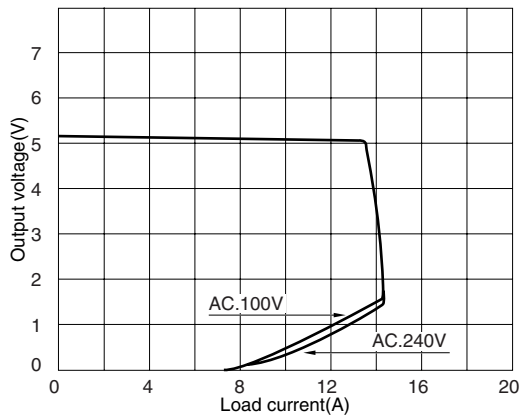

## AC.100V/200V TYPE: +60°C OVERCURRENT CURVE

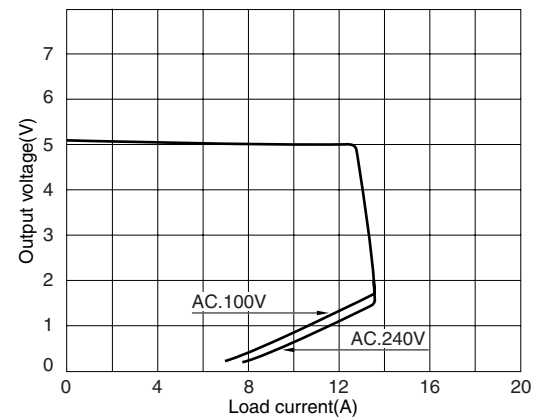

• All specifications are subject to change without notice.

# Characteristics, Functions, and Applications

## JBW50W TYPE TYPICAL CHARACTERISTICS: JBW05-10R

### AC.100V TYPE: LIFE OF ELECTROLYTIC CAPACITOR

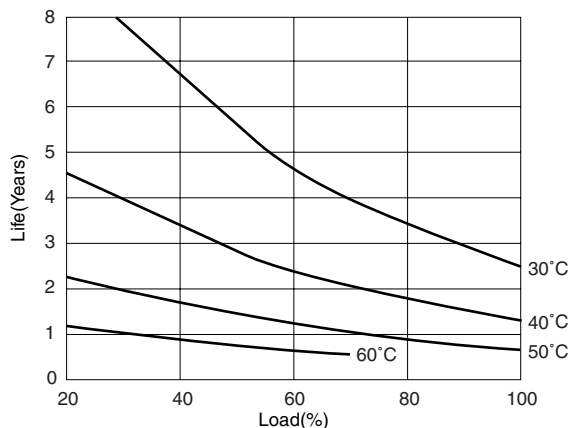

### AC.200V TYPE: LIFE OF ELECTROLYTIC CAPACITOR

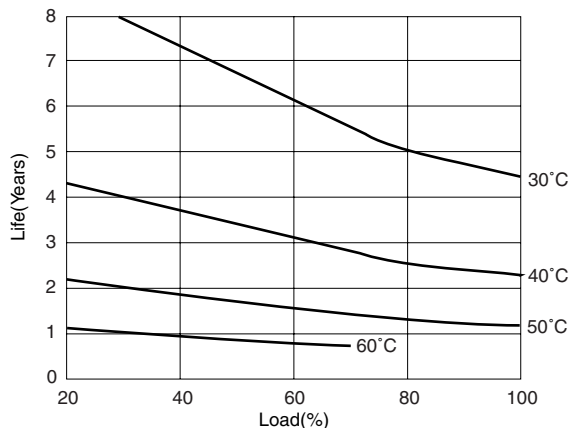

### AC.100V TYPE: HOLD UP TIME

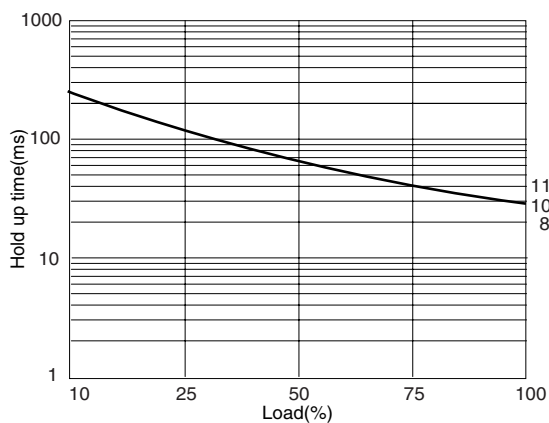

### AC.200V TYPE: HOLD UP TIME

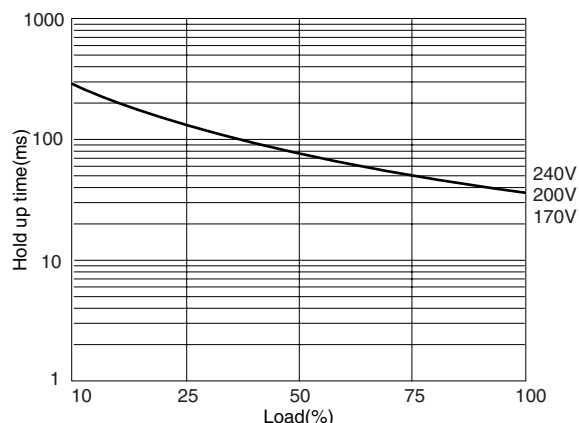

## CONDUCTIVE NOISE EMISSION

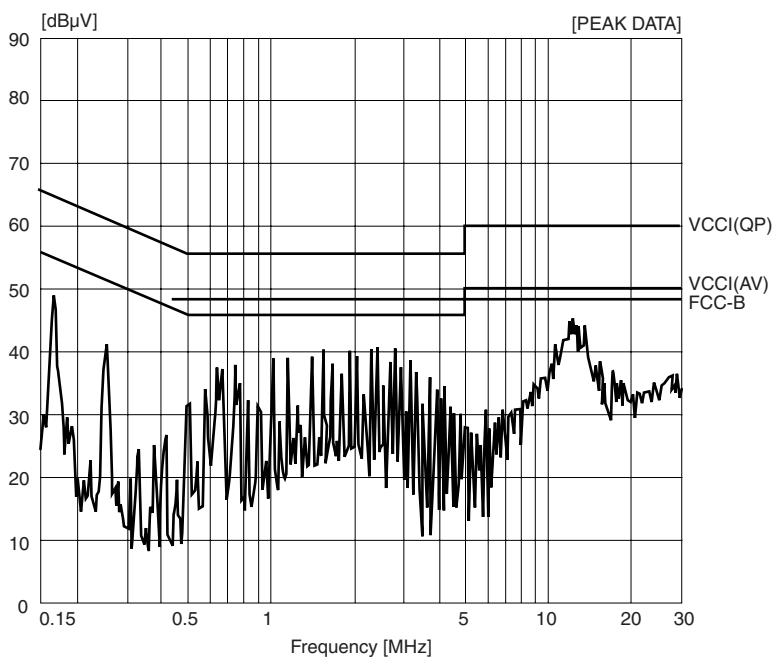

• All specifications are subject to change without notice.

## Free Manuals Download Website

<http://myh66.com>

<http://usermanuals.us>

<http://www.somanuals.com>

<http://www.4manuals.cc>

<http://www.manual-lib.com>

<http://www.404manual.com>

<http://www.luxmanual.com>

<http://aubethermostatmanual.com>

Golf course search by state

<http://golfingnear.com>

Email search by domain

<http://emailbydomain.com>

Auto manuals search

<http://auto.somanuals.com>

TV manuals search

<http://tv.somanuals.com>