

# OPERATING INSTRUCTIONS

TLM-1503 / TLM-1703

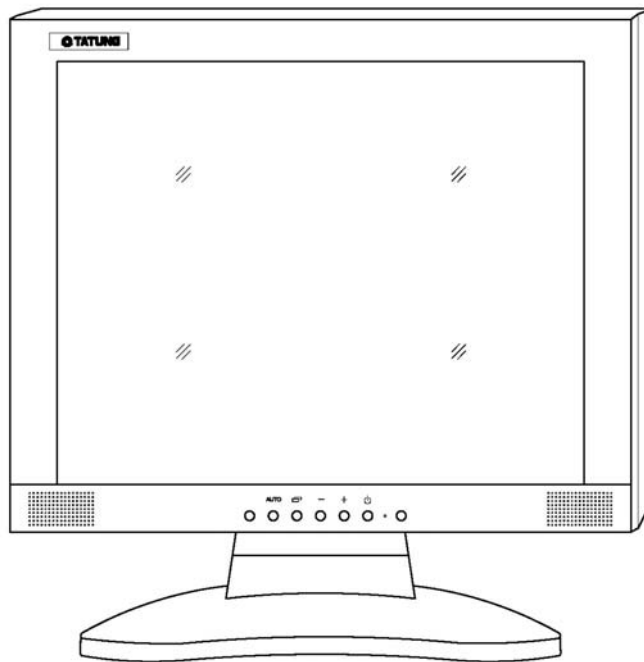

# Introduction

<b>Product Description</b>	.....	<b>2</b>
<b>Package Contents</b>	.....	<b>2</b>
<b>Product Features</b>	.....	<b>2</b>
<b>Cleaning</b>	.....	<b>3</b>
<b>Precautions</b>	.....	<b>3</b>
<b>Control Function</b>	.....	<b>4</b>
<b>OSD Control</b>	.....	<b>5</b>
<b>HOT Control</b>	.....	<b>6</b>
<b>Inputs/Outputs</b>	.....	<b>7</b>
<b>Display Angle</b>	.....	<b>8</b>
<b>Product Specification</b>	.....	<b>9</b>
<b>Display Modes</b>	.....	<b>10</b>
<b>Option Rack Mount Kit</b>	.....	<b>11</b>



## INTRODUCTION

### Product Description

Congratulations on purchasing your new 15", 17" TLM monitor. Your LCD monitor incorporates a high quality display into a small light weight module. It has power-saving capabilities and emits no X-ray radiation.

This LCD monitor incorporates 15", 17" color active matrix thin-film transistor (TFT) liquid crystal display to provide superior display performance. A maximum resolution of 1280 x 1024 SXGA is ideal for displaying complex graphics and high definition images. Additional features that enhance this LCD monitor's performance are Plug & Play compatibility, audio system, and OSD (On Screen Display) controls.

### Package Contents

- ✍ 15" or 17" TFT LCD monitor
- ✍ 15 pin D-sub signal cable
- ✍ AC power cable
- ✍ Operating Instructions

### Product Features

- ✍ High contrast color TFT LCD display supports resolution up to 1280 x 1024 SXGA for 17" & 1024x768 XGA for 15".
- ✍ Compatible with IBM, VGA, VESA, and Macintosh standards.
- ✍ Imbedded audio system provides high performance.
- ✍ BNC video input and Loop through output
- ✍ DIN S-Video input and Loop through output
- ✍ RCA Audio inputs and outputs



## **CLEANING**

- ✍ Gently wipe your screen with a clean camel hair brush or a soft, clean, lint-free cloth
- ✍ Gently apply pressure to the screen surface to clean display
- ✍ Do not spray ANY liquid directly on the screen or casing of the LCD monitor
- ✍ Chemical cleaners have been reported to damage the screen or the LCD monitor

## **PRECAUTIONS**

- ✍ Do not block vent holes with any objects
- ✍ Do not insert sharp objects or spill hazardous material onto the LCD (may cause fire, electric shock, or failure)
- ✍ Disconnect the power plug from the AC outlet if you anticipate infrequent use
- ✍ Do not attempt to service this product yourself. Opening or removing casing may expose you to dangerous voltage points or other significant risks
- ✍ Avoid touching the screen directly with your fingers as the oils from your skin may be difficult to remove from the LCD
- ✍ Do not apply direct pressure on the screen
- ✍ Do not remove or modify any prongs from the power cord
- ✍ Disconnect the power plug from the AC outlet when the power cord or plug is damaged
- ✍ If the monitor case is damaged or the monitor malfunctions, do not try to repair yourself. Un-authorized repair will void your product warranty
- ✍ Do not allow any object to rest on the power cord
- ✍ Do not place this product in a high traffic environment where cord is exposed
- ✍ Always use the proper power cord with the correct plug adapter. If the power source is 120V AC, use a power cord that has UL and C-UL approvals. If the power source is 240V AC, use the tandem (T-blade) plug with a grounding that meets European country safety regulations (such as VDE for Germany)
- ✍ Do not overload wall outlets or power cords. Ensure total units plugged into wall does not exceed 10 amperes
- ✍ Ensure total current plugged into the extension cord does not exceed cords current rating
- ✍ Place monitor in a well ventilated environment
- ✍ Do not place monitor directly under sunlight or in cold, humid environments
- ✍ Keep monitor in a dust-free environment and away from strong electro-magnetic fields



## CONTROL FUNCTION

### Front View

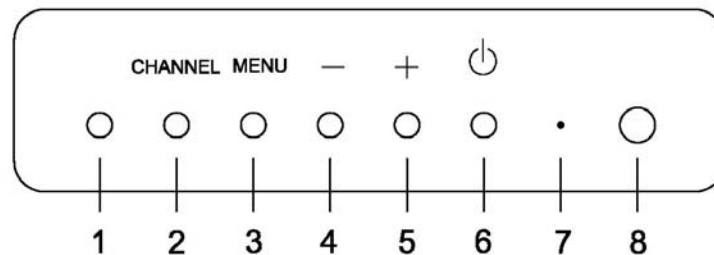
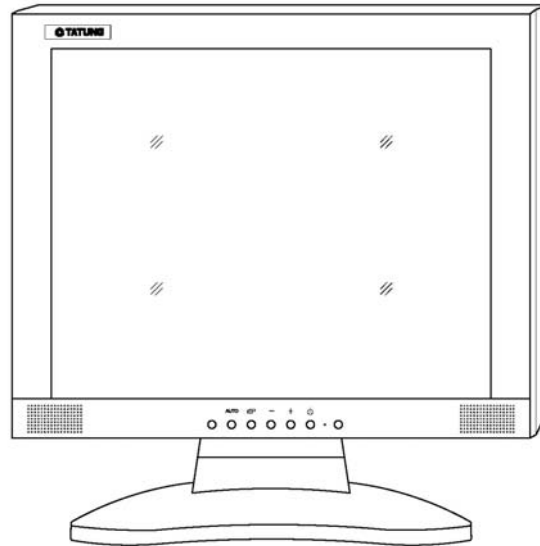

- |                      |   |
|----------------------|---|
| 1. Light sensor      | Compensate light output to optimize brightness                              |
| 2. Channel           | Select input mode: VGA>VIDEO>S-VIDEO>VGA>...                                |
| 3. OSD menu          | Selects OSD control options on the screen                                   |
| 4. Decrease          | Decreases the value of selected OSD control option and decreases the volume |
| 5. Increase          | Increases the value of selected OSD control option and increases the volume |
| 6. Power switch      | Turns power on/off  |
| 7. Power LED         | Indicates different status when unit operates in different modes            |
| 8. Infrared Receiver |   |



# OSD CONTROL

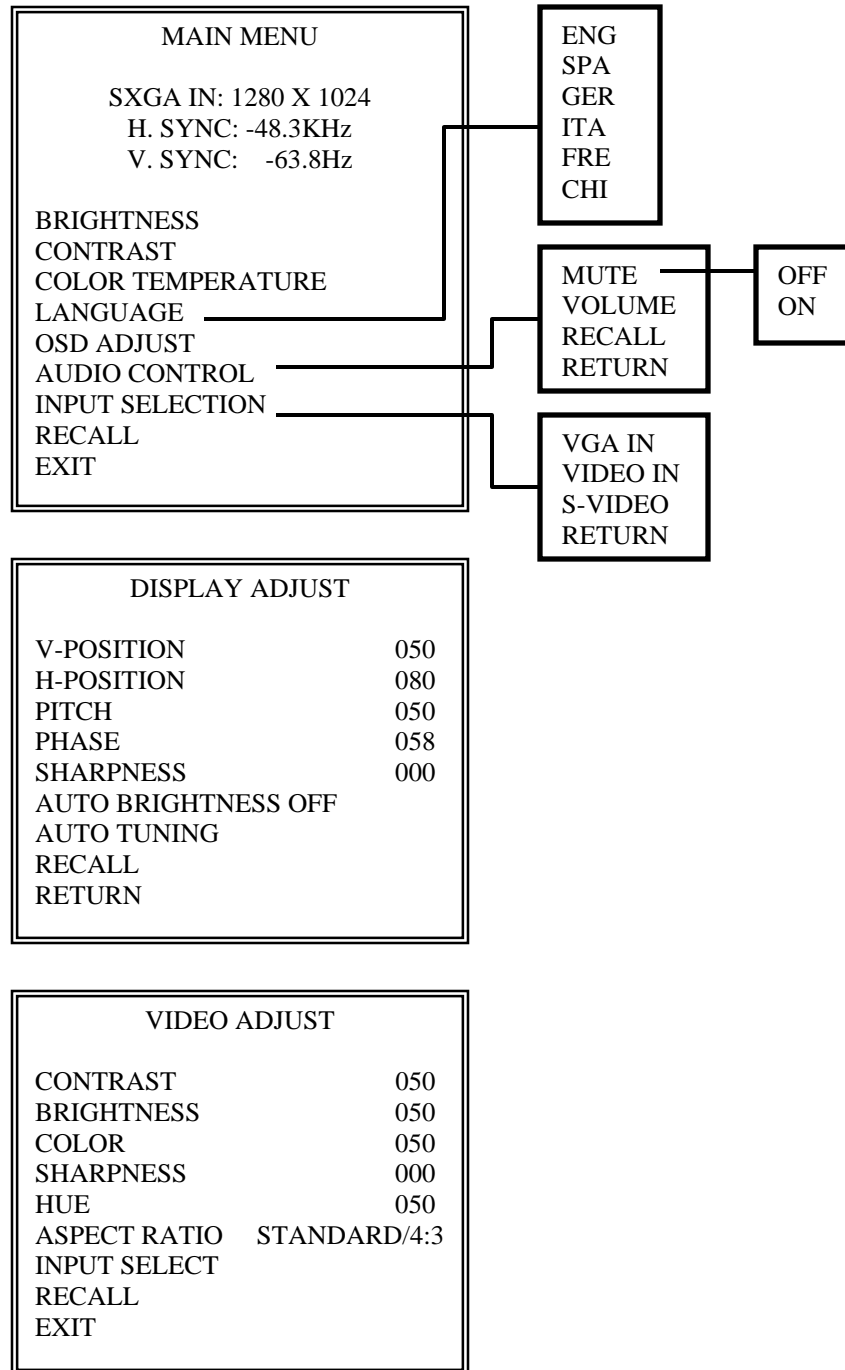

**Note: There is no "ASPECT RATIO" for 15" model.**



BRIGHTNESS:	Adjusts background black level of the screen image
CONTRAST:	Adjusts foreground white level of the screen image
H. POSITION:	Moves the screen image left or right
V. POSITION:	Moves the screen image up or down
PITCH:	Adjusts image distortion appearing as vertical bars or “noise” on the screen
PHASE:	Adjusts image distortion appearing as horizontal bars or “noise” on the screen
SHARPNESS:	Adjusts the clarity and focus of the screen image
COLOR METER:	Adjusts color temperature
LANGUAGE:	Allows you to choose from English, French, German, Italian, or Spanish
AUDIO CONTROL:	Switch muting ON/OFF and controls volume
INPUT SELECTION:	Selects VGA, VIDEO, S-VIDEO signal inputs
RECALL:	Returns all controls back to default settings

## **HOT KEY CONTROL**

1. VGA HOT KEY  
UP KEY > BRIGHTNESS  
DOWN KEY > CONTRAST
  
2. VGA + HOT KEY  
UP KEY > VOLUME INCREASE  
DOWN KEY > VOLUME DECREASE



## INPUTS/OUTPUTS

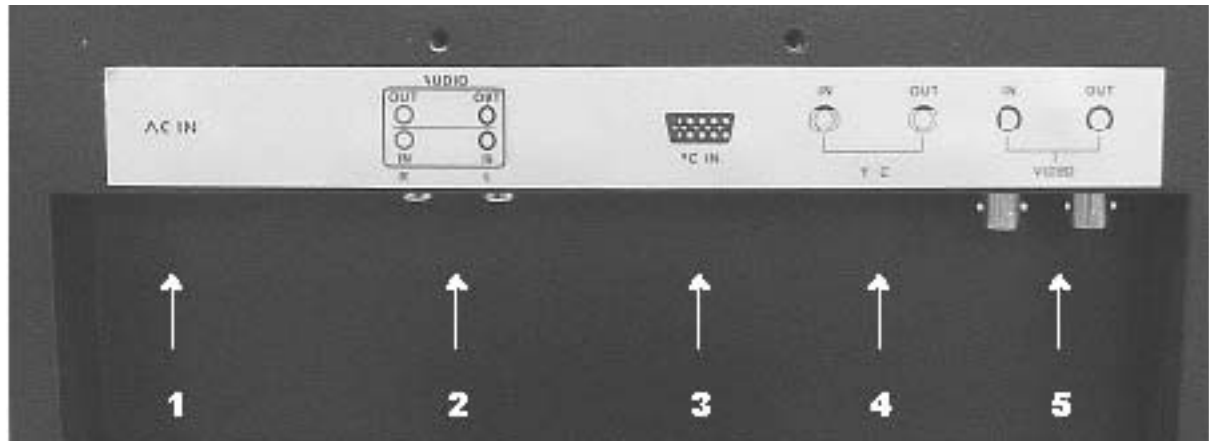

- |                          |   |
|--------------------------|---|
| 1. AC POWER INPUT:       | AC inlet for 110/220V power system  |
| 2. AUDIO INPUT/OUTPUT:   | Audio signal can be input into RCA sockets and loop through out             |
| 3. PC INPUT:             | This D-Sub 15 socket can be connected to a PC or DVR                        |
| 4. S-VIDEO INPUT/OUTPUT: | S-Video signal can be input into this DIN socket and loop through out       |
| 5. VIDEO INPUT/OUTPUT:   | Composite video signal can be input in this BNC socket and loop through out |

## DISPLAY ANGLE





The TLM-1503 / TLM-1703 can be manually adjusted to desirable angles.

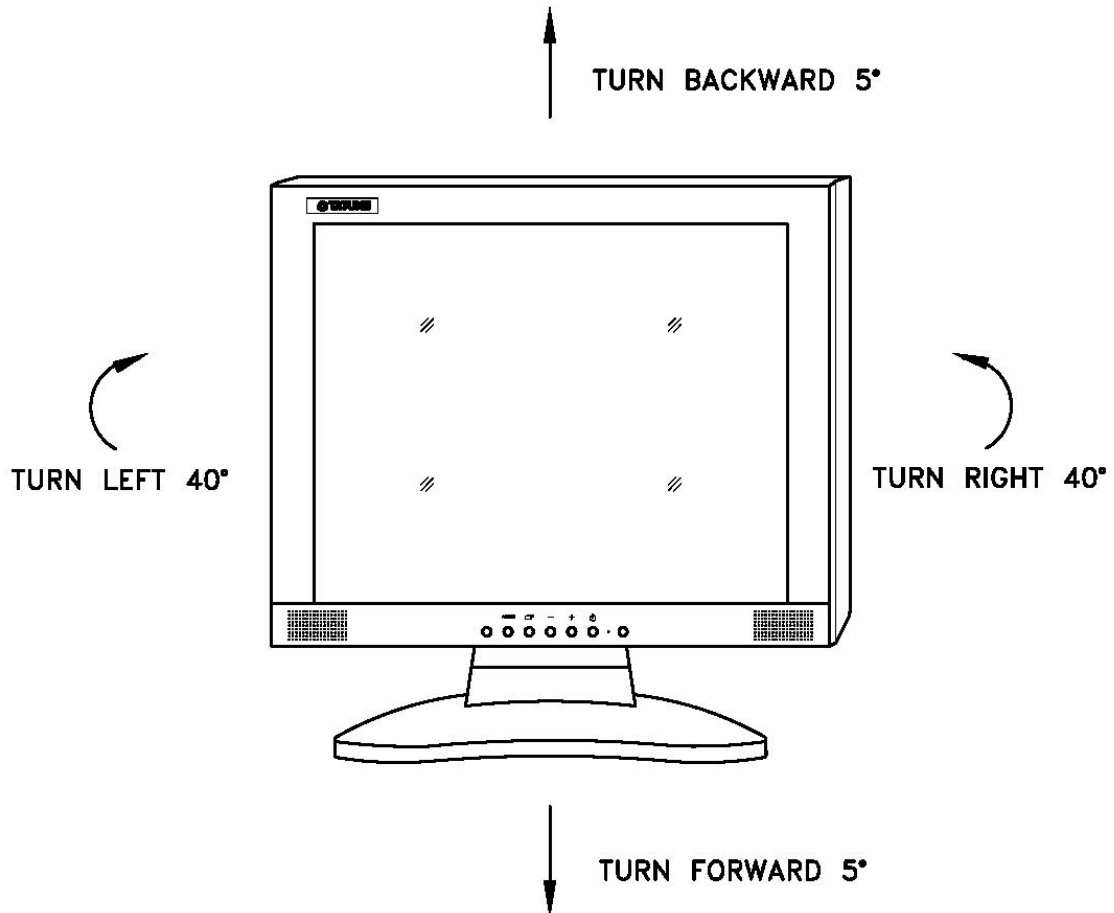

<b>PRODUCT SPECIFICATIONS</b>	
LCD Display	15" or 17" active matrix TFT LCD panel
Pixel pitch	15" 0.297(H) x 0.297(V)mm 17" 0.264(H) x 0.264(V)mm
Max. Resolution	15" - 1024(H) x 768(V) XGA 17" - 1280(H) x 1024(V) SXGA
Dimensions	448(V) x 430(H) x 200(D) mm
Packing Dimensions	475(V) x 475(H) x 220(D) mm
Contrast Ratio	500:1 (Typ.)
Brightness	15" - 400 Nit / 17" - 430Nit
Display Color	16.2M
Viewing Angle L/R U/D	15" 140° (Typ.) / 17" 140° (Typ.) 125° (Typ.) / 130° (Typ.)
I/O interface Video Sync.	RGB analog 0.7Vp-p TTL positive or negative Composite, Y/C
Display Mode	15" VGA / SVGA / XGA 17" VGA / SVGA / XGA / SXGA
PC connector	15 MIN d-SUB, s-Video connector, BNC video connector
Front control	Power on/off with LED, Menu select, Up/Down adjustment, Auto tuning, Light sensor
OSD adjustment	Contrast, Brightness, Auto tuning, Phase, H- Position, V-Position, Input selection
Power supply	AC Input: 100~240V/1.8A, 50-60Hz
Operating conditions	Humidity: 20%~80% Temperature: 0° C ~ 40° C
Storage conditions	Humidity: 10% ~ 90% Temperature: -20° C ~ 60° C
Certification	FCC, CE, UL, CUL
Weight	N/W: 6.5Kgs G/W: 8kgs



## **DISPLAY MODES**

<b>Model</b>	<b>Resolution</b>	<b>H Freq (kHz)</b>	<b>V Freq (kHz)</b>
0	720 x 350	31.469	70.087
1	640 x 480	31.469	59.940
2	640 x 480	35.000	66.667
3	640 x 480	37.861	72.809
4	640 x 480	37.500	75.000
5	720 x 400	31.469	70.087
6	800 x 600	35.156	56.250
7	800 x 600	37.879	60.317
8	800 x 600	48.077	72.188
9	800 x 600	46.875	75.000
10	832 x 624	49.750	74.500
11	1024 x 768	48.363	60.004
12	1024 x 768	56.476	70.069
13	1024 x 768	58.038	71.918
14	1024 x 768	60.023	75.029
*15	1280 x 1024	64.000	60.000
*16	1280 x 1024	80.000	75.000

Note: \*Only 17" can support up to 1280x1024

## **SERVICE INFORMATION**

If you experience problems with this product, please contact us at (800) 829-2850 or (310) 637-2105 and ask for:

Gale Kroth, Service Rep ext. 242

Larry Chen, Service manager, ext. 216



**OPTION RACK MOUNT KIT: TRK-1703C**

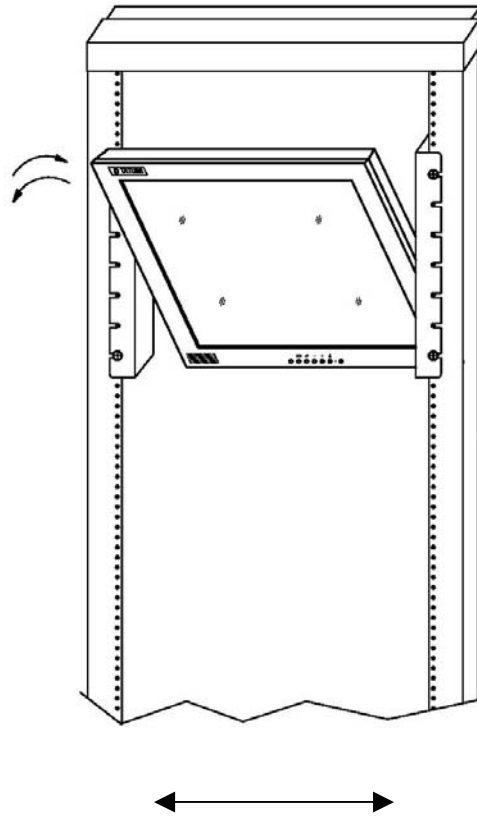

19" EIA STANDARD OPEN RACK

## **TATUNG COMPANY OF AMERICA**

2850 El Presidio Street  
Long Beach, CA 90810  
(800) 827-2850

---

[www.tatungusa.com](http://www.tatungusa.com)



## Free Manuals Download Website

<http://myh66.com>

<http://usermanuals.us>

<http://www.somanuals.com>

<http://www.4manuals.cc>

<http://www.manual-lib.com>

<http://www.404manual.com>

<http://www.luxmanual.com>

<http://aubethermostatmanual.com>

Golf course search by state

<http://golfingnear.com>

Email search by domain

<http://emailbydomain.com>

Auto manuals search

<http://auto.somanuals.com>

TV manuals search

<http://tv.somanuals.com>