



CR-H227i

CD Receiver

OWNER'S MANUAL MANUEL DU PROPRIÉTAIRE MANUAL DEL USUARIO

ENGLISH

FRANÇAIS

ESPAÑOL

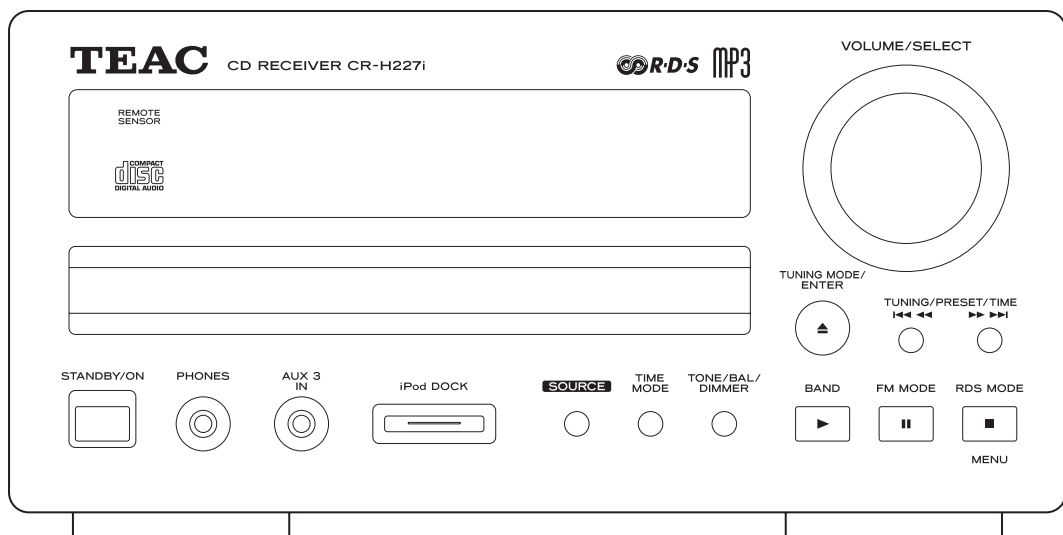

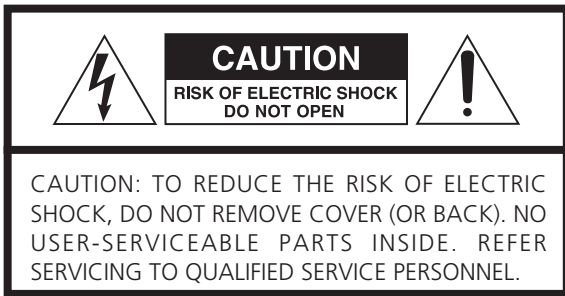

The lightning flash with arrowhead symbol, within an equilateral triangle, is intended to alert the user to the presence of uninsulated "dangerous voltage" within the product's enclosure that may be of sufficient magnitude to constitute a risk of electric shock to persons.



The exclamation point within an equilateral triangle is intended to alert the user to the presence of important operating and maintenance (servicing) instructions in the literature accompanying the appliance.

IMPORTANT SAFETY INSTRUCTIONS

- 1) Read these instructions.
- 2) Keep these instructions.
- 3) Heed all warnings.
- 4) Follow all instructions.
- 5) Do not use this apparatus near water.
- 6) Clean only with dry cloth.
- 7) Do not block any ventilation openings. Install in accordance with the manufacturer's instructions.
- 8) Do not install near any heat sources such as radiators, heat registers, stoves, or other apparatus (including amplifiers) that produce heat.
- 9) Do not defeat the safety purpose of the polarized or grounding-type plug. A polarized plug has two blades with one wider than the other. A grounding type plug has two blades and a third grounding prong. The wide blade or the third prong are provided for your safety. If the provided plug does not fit into your outlet, consult an electrician for replacement of the obsolete outlet.
- 10) Protect the power cord from being walked on or pinched particularly at plugs, convenience receptacles, and the point where they exit from the apparatus.
- 11) Only use attachments/accessories specified by the manufacturer.
- 12) Use only with the cart, stand, tripod, bracket, or table specified by the manufacturer, or sold with the apparatus. When a cart is used, use caution when moving the cart/apparatus combination to avoid injury from tip-over. 
- 13) Unplug this apparatus during lightning storms or when unused for long periods of time.
- 14) Refer all servicing to qualified service personnel. Servicing is required when the apparatus has been damaged in any way, such as power-supply cord or plug is damaged, liquid has been spilled or objects have fallen into the apparatus, the apparatus has been exposed to rain or moisture, does not operate normally, or has been dropped.

- Do not expose this apparatus to drips or splashes.
- Do not place any objects filled with liquids, such as vases, on the apparatus.
- Do not install this apparatus in a confined space such as a book case or similar unit.
- The apparatus draws nominal non-operating power from the AC outlet with its STANDBY/ON switch in the standby position.
- The apparatus should be located close enough to the AC outlet so that you can easily grasp the power cord plug at any time.
- An apparatus with Class I construction shall be connected to an AC outlet with a protective grounding connection.
- Batteries (battery pack or batteries installed) shall not be exposed to excessive heat such as sunshine, fire or the like.
- Excessive sound pressure from earphones and headphones can cause hearing loss.

WARNING: TO PREVENT FIRE OR SHOCK HAZARD, DO NOT EXPOSE THIS APPLIANCE TO RAIN OR MOISTURE.

CAUTION

- DO NOT REMOVE THE EXTERNAL CASES OR CABINETS TO EXPOSE THE ELECTRONICS. NO USER SERVICEABLE PARTS ARE WITHIN!
- IF YOU ARE EXPERIENCING PROBLEMS WITH THIS PRODUCT, CONTACT TEAC FOR A SERVICE REFERRAL. DO NOT USE THE PRODUCT UNTIL IT HAS BEEN REPAIRED.
- USE OF CONTROLS OR ADJUSTMENTS OR PERFORMANCE OF PROCEDURES OTHER THAN THOSE SPECIFIED HEREIN MAY RESULT IN HAZARDOUS RADIATION EXPOSURE.

Disposal of your old appliance



1. When this crossed-out wheeled bin symbol is attached to a product it means the product is covered by the European Directive 2002/96/EC.
2. All electrical and electronic products should be disposed of separately from the municipal waste stream via designated collection facilities appointed by the government or the local authorities.
3. The correct disposal of your old appliance will help prevent potential negative consequences for the environment and human health.
4. For more detailed information about disposal of your old appliance, please contact your city office, waste disposal service or the shop where you purchased the product.

Contents

Thank you for choosing TEAC. Read this manual carefully to get the best performance from this unit.

Important Safety Instructions	2
Before Use	4
Contents	4
Discs	6
Connection	8
Connecting Antennas	12
Identifying the Parts	14
Remote Control Unit	18

Basic Operation	19
---------------------------	----

iPod

Getting started with iPod	22
Listening to iPod	23

CD/MP3/WMA

Listening to CD/MP3/WMA	26
Direct Playback	28
Repeat Playback	29
Programmed Playback	30
Shuffle Playback	32
Time Display	32

TUNER

Listening to the Radio	33
Preset Tuning	34
RDS	36
RDS (PTY Search)	37
RDS (PTY)	38

Setting the Clock	39
Setting the Timer	40

Troubleshooting	42
Specifications	43

Before Use

Read this before operation

- As the unit may become warm during operation, always leave sufficient space around the unit for ventilation.
- The voltage supplied to the unit should match the voltage as printed on the rear panel. If you are in any doubt regarding this matter, consult an electrician.
- Choose the installation location of your unit carefully. Avoid placing it in direct sunlight or close to a source of heat. Also avoid locations subject to vibrations and excessive dust, heat, cold or moisture.
- Do not place the unit on an amplifier/receiver.
- Do not open the cabinet as this might result in damage to the circuitry or electrical shock. If a foreign object should get into the set, contact your dealer or service agency.
- When removing the power plug from the wall outlet, always pull directly on the plug, never yank the cord.
- To keep the laser pickup clean, do not touch it, and do not forget to close the disc tray when not using the CD player.
- Do not attempt to clean the unit with chemical solvents as this might damage the finish. Use a clean, dry cloth.
- Keep this manual in a safe place for future reference.

DO NOT MOVE THE UNIT DURING PLAYBACK

During playback, the disc rotates at high speed. Do NOT lift or move the unit during playback. Doing so may damage the disc.

WHEN MOVING THIS UNIT

When changing places of installation or packing the unit for moving, be sure to remove the disc and return the disc table to its original position in the player. Then, press the power switch to turn the power off, and disconnect the power cord. Moving this unit with the disc loaded may result in damage to this unit.

Maintenance

If the surface of the unit gets dirty, wipe with a soft cloth or use diluted neutral cleaning liquid. Be sure to remove any fluid completely. Do not use thinner, benzene or alcohol as they may damage the surface of the unit.

Beware of condensation

When the unit (or a disc) is moved from a cold to a warm place, or used after a sudden temperature change, there is a danger of condensation; vapor in the air could condense on the internal mechanism, making correct operation impossible. To prevent this, or if this occurs, leave the unit for one or two hours with the power turned on. The unit will stabilize at the temperature of its surroundings.

Memory Backup

If the power supply is interrupted for 14 days or longer, all the settings kept in memory (such as preset stations and timer settings) will be erased.

It will take more than 3 days after plugging the power cord into the outlet to charge enough electricity for the memory backup function.

Restoring factory settings

If you want to manually initialize the settings, restore the unit to the factory settings as follows:

1. If the unit is on, turn it off (standby).
2. Hold down the FM MODE button for more than 4 seconds until the unit turns on.

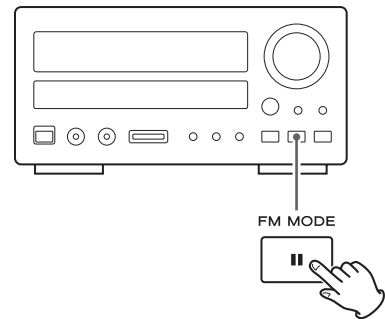

All memories are erased, and the unit returns to the factory settings.

Discs which can be played on this unit:

- Conventional audio CDs bearing the COMPACT DISC DIGITAL AUDIO logo on the label:



- Properly finalized CD-R and CD-RW discs
- MP3 CDs

Note:

- Depending on the quality of the disc and/or the condition of the recording, some CD-R/CD-RW discs may not be playable.
- Copy-protected discs and other discs that do not conform to the CD standard may not play back correctly in this player. If you use such discs in this unit, TEAC Corporation and its subsidiaries cannot be responsible for any consequences or guarantee the quality of reproduction. If you experience problems with such non-standard discs, you should contact the producers of the disc.

- Always place the disc on the disc tray with the label side up. (Compact discs can be played or recorded only on one side.)
- To remove a disc from its storage case, press down on the center of the case and lift the disc out, holding it carefully by the edges.
- Always place the disc on the disc tray with the label side up. (Compact discs can be played or recorded only on one side.)

- To remove a disc from its storage case, press down on the center of the case and lift the disc out, holding it carefully by the edges.



How to remove the disc



How to hold the disc

- Should the disc become dirty, wipe the surface radially (from the center hole outward towards the outer edge) with a soft, dry cloth:

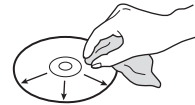

- Never use such chemicals as record sprays, antistatic sprays or fluid, benzine or thinner to clean the discs. Such chemicals will do irreparable damage to the disc's plastic surface.
- Discs should be returned to their cases after use to avoid dust and scratches that could cause the laser pickup to "skip."
- Do not expose discs to direct sunlight or high humidity and temperature for extended periods. Long exposure to high temperatures will warp the disc.
- Do not play any disc that is warped, deformed or damaged. Playing such discs may cause irreparable harm to the playing mechanisms.

- CD-R and CD-RW discs are more sensitive to the effects of heat and ultraviolet rays than ordinary CDs. It is important that they are not stored in a location where direct sunlight will fall on them, and which is away from sources of heat such as radiators or heat-generating electrical devices.
- Printable discs aren't recommended, as the label side might be sticky and damage the unit.
- Do not stick papers or protective sheets on the discs and do not use any protective coating spray.
- Use a soft oil-based felt-tipped pen to write the information on the label side. Never use a ball-point or hard-tipped pen, as this may cause damage to the recorded side.
- Never use a stabilizer. Using commercially available CD stabilizers with this unit will damage the mechanisms and cause them to malfunction.
- Do not use irregular shape discs (octagonal, heart shaped, business card size, etc.). Discs of this sort can damage the unit:

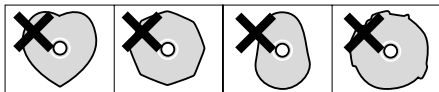

- If you are in any doubt as to the care and handling of a disc, read the precautions supplied with the disc, or contact the disc manufacturer directly.

MP3 and Windows Media-formatted audio files

- This unit can play MP3 and Windows Media-formatted audio files recorded on a CD-R or CD-RW.
(Windows Media is a trademark of Microsoft Corporation.)
- File names of MP3 or WMA should be alphanumeric characters. This unit cannot display symbols and full-size or double-byte characters (such as Japanese, Chinese, etc.) correctly. Also, be sure to use the file extension. (".mp3" for MP3 files, ".wma" for WMA files.)
- MP3 files are monaural or stereo MPEG-1 Audio Layer 3 format. This unit can play MP3 files with sampling frequency 44.1 kHz or 48 kHz, bit-rate 320 kbps or less.
- This unit can play WMA files with sampling frequency 44.1 kHz, bit-rate 192 kbps or less.
- The disc must be finalized in order to play.
- The CD-ROM must be ISO 9660 compatible.
- When more than 255 files (including folders) are recorded on the disc, the unit might not be able to play it correctly.

Connection 1

CAUTION:

- Switch off the power to all equipment before making connection.
- Read the instructions of each component you intend to use with this unit.
- Be sure to insert each plug securely. To prevent hum and noise, avoid bundling the signal interconnection cables together with the AC power cord or speaker cables.

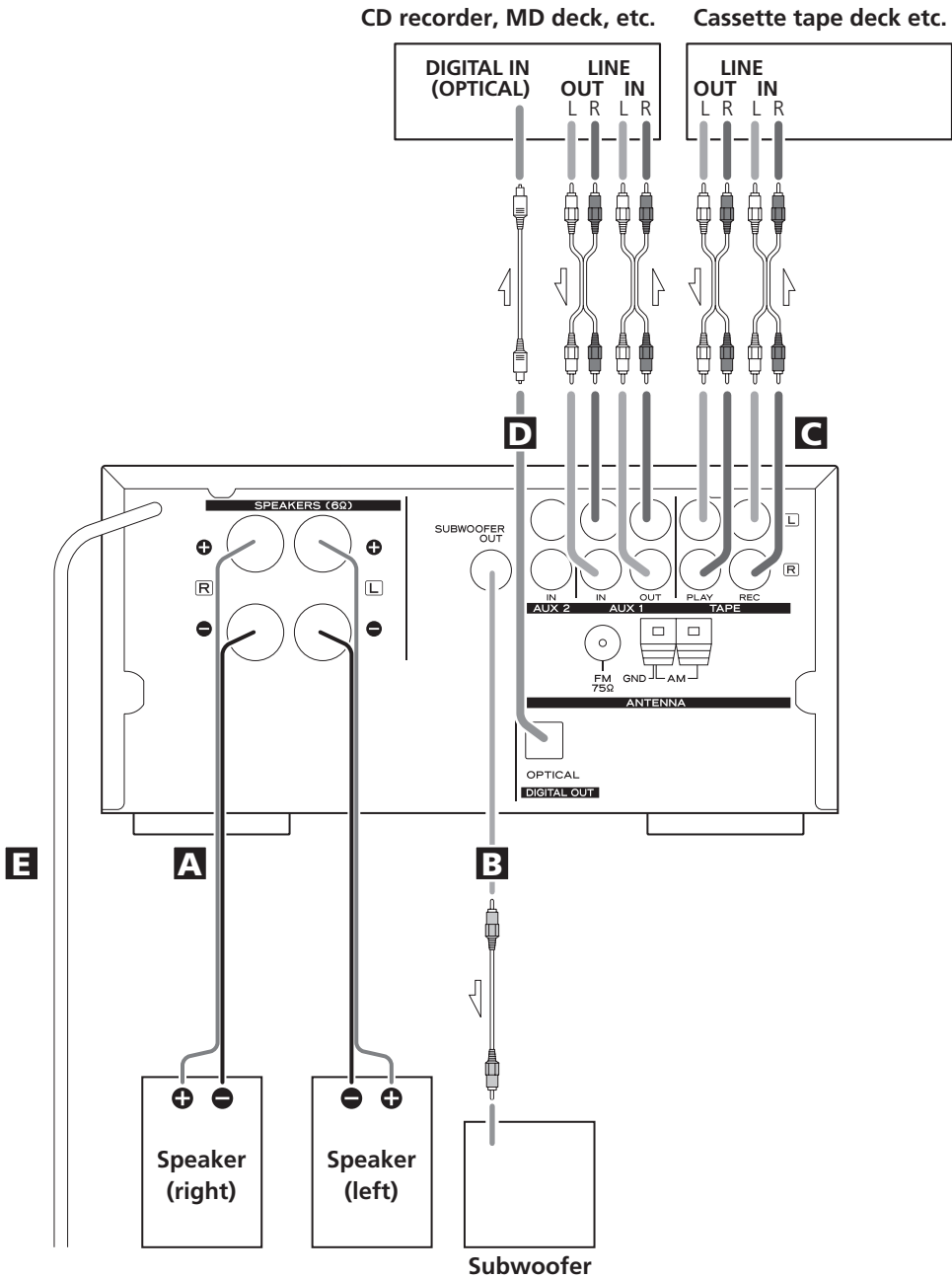

A Speaker Terminals

- Use commercially available speaker cables.
- The black speaker terminals are – (negative). Generally, the + side of the speaker cable is marked to make it distinguishable from the – side of the cable. Connect this marked side to the + terminal and the unmarked side to the black – terminal.

Caution:

- To avoid damaging the speakers with a sudden high-level signal, be sure to switch the power off before connecting the speakers.
- Check the impedance of your speakers. Connect speaker with an impedance of 6 ohms or more.
- The metal portions of the two separate wires should not touch or an electrical short can occur. Shorted wires can create a fire hazard or induce a failure in your equipment.

How to connect speakers:

1. Prepare the speaker cables for connection by stripping off approximately 10 mm (1/2") or less of the outer insulation. (Removing too much insulation may lead to a short circuit if the bared wires should come in contact with each other.) Twist the strands of the stripped wires tightly together.

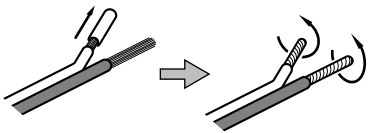

2. Turn the terminal cap counterclockwise to loosen it. The speaker terminal caps cannot be fully removed from the base.
3. Insert the wire into the terminal and turn the terminal cap clockwise to securely connect it:

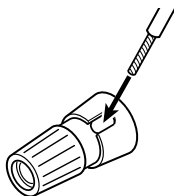

Make sure none of the wire insulation is under the terminal, only the bare, stripped wire.

4. Make sure it is fastened firmly by pulling the cable lightly.

B Subwoofer

Connect a subwoofer using a commercially-available RCA cable.

Use a subwoofer with built-in amplifier referred to as a "powered subwoofer".

C TAPE/AUX1/AUX2 jacks

Analog 2-channel audio signal is input or output from these jacks. Connect a cassette tape deck, CD recorder, DVD player, etc. using commercially-available RCA cables.

Make sure to connect:

- white plug → white jack (L: left channel)
- red plug → red jack (R: right channel)

D DIGITAL OUT terminal (optical)

Digital 2-channel audio signal is output from this terminal.

Connect it to the digital input terminal of a digital device such as a CD recorder, MD deck, etc. Use a commercially-available optical digital cable.

- The optical terminal is covered by a shutter. Make sure that the cable is firmly inserted, but do not force the cable when connecting it or removing it, in order not to cause damage to the unit.

E AC Power Cord

After all other connections have been completed, connect the plug to the AC wall socket.

Be sure to connect the power cord to an AC outlet which supplies the correct voltage. Hold the power plug when plugging or unplugging the power cord.

Connection 2

TV or Monitor

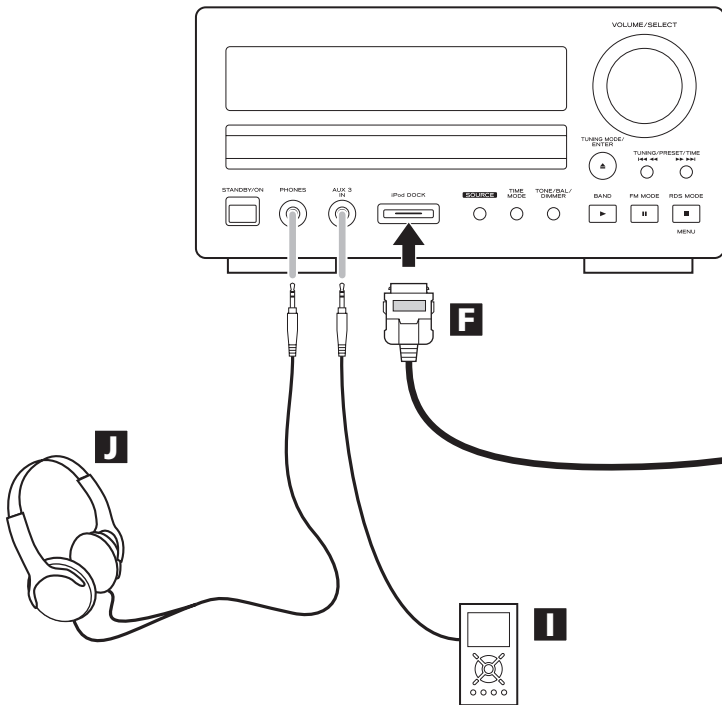
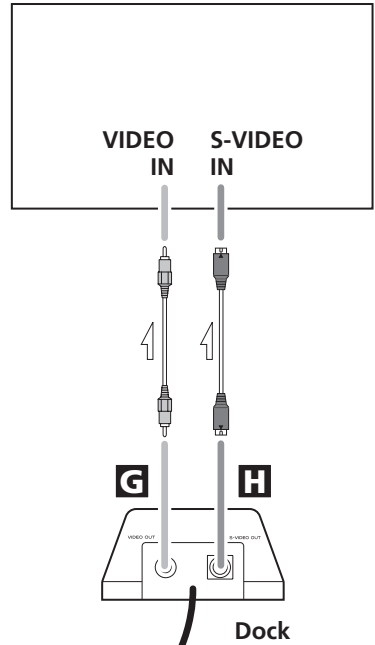

F iPod Dock

Connect the Dock to the iPod port.

- Make sure the label side of the plug is up.
- Securely insert the plug until a slight "click" is heard.

To disconnect the Dock:

Squeeze both sides of the plug and pull.

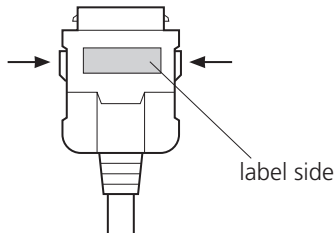

G VIDEO OUT terminal

This terminal outputs video signal from iPod.

Use an RCA (pin) video cable to connect the Dock to the composite video connector of a television or monitor.

- Select "Click Wheel Mode" to output video signal (see page 24).

H S-VIDEO OUT terminal

This terminal outputs video signal from iPod.

Use an S-Video cable to connect the Dock to the S-Video input of a suitably equipped television or monitor. Use this connection in preference to a composite video connection.

- Select "Click Wheel Mode" to output video signal (see page 24).

I AUX 3 IN

You can connect a portable audio player to this jack.

Connect the LINE OUT or PHONES jack (audio output jack) of the player using a commercially available stereo mini plug cable.

- When using the PHONES jack of your mini player, you must adjust the volume of the mini-player or you may hear no sound from your CR-H227i.

J Headphones

For private listening, insert the headphones plug into this jack, and adjust the volume by turning the VOLUME knob.

Connecting Antennas

AM Indoor Loop Antenna

The high-performance AM loop antenna provided with this unit is sufficient for good reception in most areas.

To stand the loop antenna on a surface, fix the claw to the slot in the antenna base.

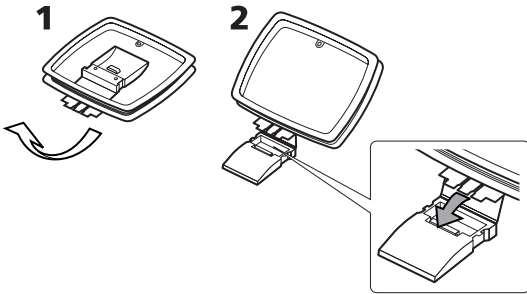

Connect the loop antenna's wires to the AM antenna terminals.

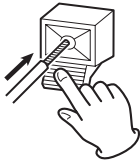

Make sure to connect:

- white wire → right terminal
- black wire → left terminal (GND)

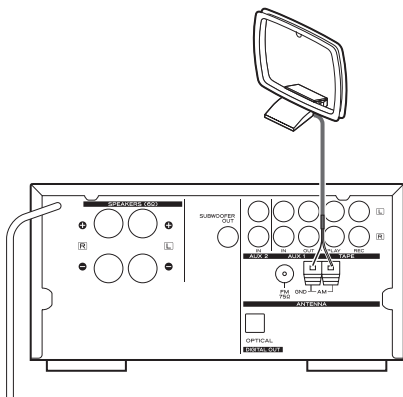

Place the antenna on a shelf or hang it on a window frame, etc., in the direction which gives the best reception. Keep all other wires such as power cords, speaker wires or interconnect wires as far away as possible from the antenna.

AM Outdoor Antenna

If the AM loop antenna provided does not deliver sufficient reception (often due to being too far from the transmitter or in a concrete building, etc.), it may be necessary to use an outdoor AM antenna. Use either a high quality commercial AM antenna or, if not available, an insulated wire more than 5 m long, strip one end, and connect this to the terminal as shown.

The antenna wire should be strung outdoors or indoors near a window. For better reception, connect the GND terminal to a reliable ground.

Note:

Even when using an outdoor AM antenna, do not disconnect the AM loop antenna.

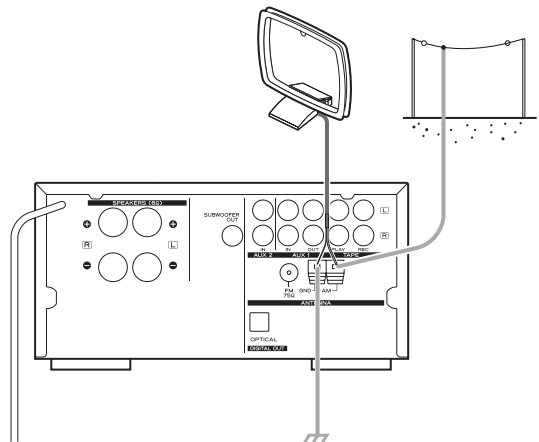

FM Indoor Antenna

Connect the lead-type FM antenna to the FM 75Ω socket, extend the lead and tune the tuner to your favorite station (see page 33). Adjust the antenna in a suitable location like a window frame or wall until the reception is best and then affix the antenna in that position using thumb tacks, push pins or any other suitable means.

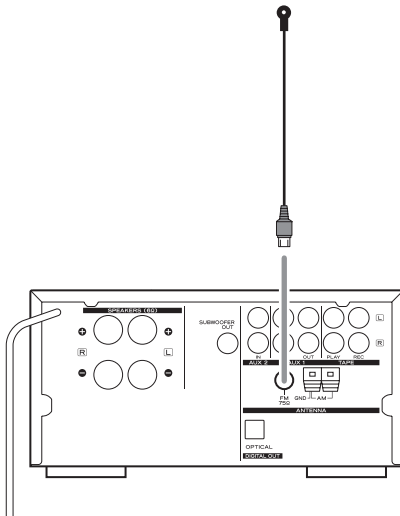

FM Outdoor Antenna

In an area where FM signals are weak, it will be necessary to use an outdoor FM antenna. Generally, a 3-element antenna will be sufficient; if you live in an area where the FM signals are particularly weak, it may be necessary to use one with 5 or more elements.

- Disconnect the FM indoor antenna when using an outdoor antenna.

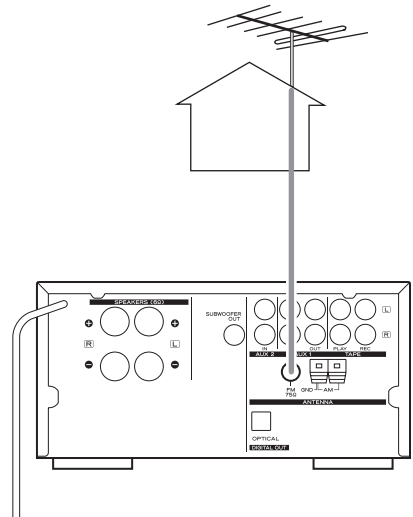

Identifying the Parts 1

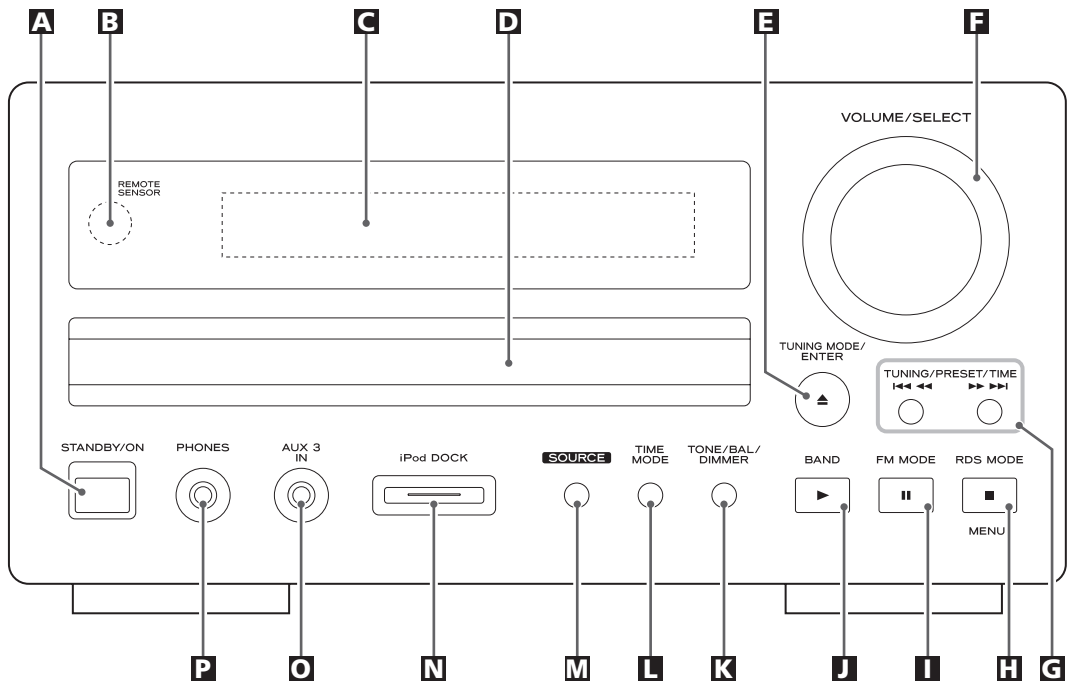

A STANDBY/ON

Press this button to turn the unit on or standby.
The standby indicator surrounding the STANDBY/ON button lights when the unit is in the standby mode.
When the unit is turned on, it goes off.

B Remote Sensor

When operating the remote control unit, point it towards the remote sensor.

C Display

D Disc tray

E OPEN/CLOSE (▲), TUNING MODE, ENTER

In CD mode, use this button to open and close the disc tray.
In TUNER mode, use this button to select the tuning mode.
While setting the timer or the clock, use this button to set the time.

In iPod mode, use this button to confirm selection in menus. This button is equivalent to the Center button on your iPod.

F VOLUME, SELECT

Turn this knob to adjust the volume.
Turn this knob to adjust the tone, balance and dimmer together with the TONE/BAL/DIMMER button.

G SKIP (◀◀◀/▶▶▶), TUNING, PRESET, TIME

In iPod or CD mode, momentarily press these buttons to skip tracks. Hold down these buttons to search for a part of a track.

In TUNER mode, use these buttons to tune in stations or select the preset stations.
While setting the clock or the timer, use these buttons to adjust the time.

H STOP (■), RDS MODE, MENU

In CD mode, use this button to stop playback.
In FM TUNER mode, this button is used to select the RDS mode.

In iPod mode, use this button to go back to the previous menu. This button is equivalent to the MENU button on your iPod.

I PAUSE (⏸), FM MODE

In iPod or CD mode, use this button to pause playback.
In FM mode, use this button to select stereo or monaural.

J PLAY (▶), BAND

In iPod or CD mode, use this button to start playback.
In TUNER mode, use this button to select FM or AM.

K TONE, BAL, DIMMER

Use this button together with the VOLUME/SELECT knob to adjust bass, treble, balance and dimmer.

L TIME MODE

Use this button to adjust the clock and to set a timer.

M SOURCE

Use this button to select a source.

N iPod port

Connect the Dock to this port
See page 22 for details.

O AUX 3 IN Jack

You can connect a portable audio player to this jack.
See page 11 for details.

P PHONES

For private listening, insert the headphones plug into this jack, and adjust the volume by turning the VOLUME/SELECT knob.

Identifying the Parts 2

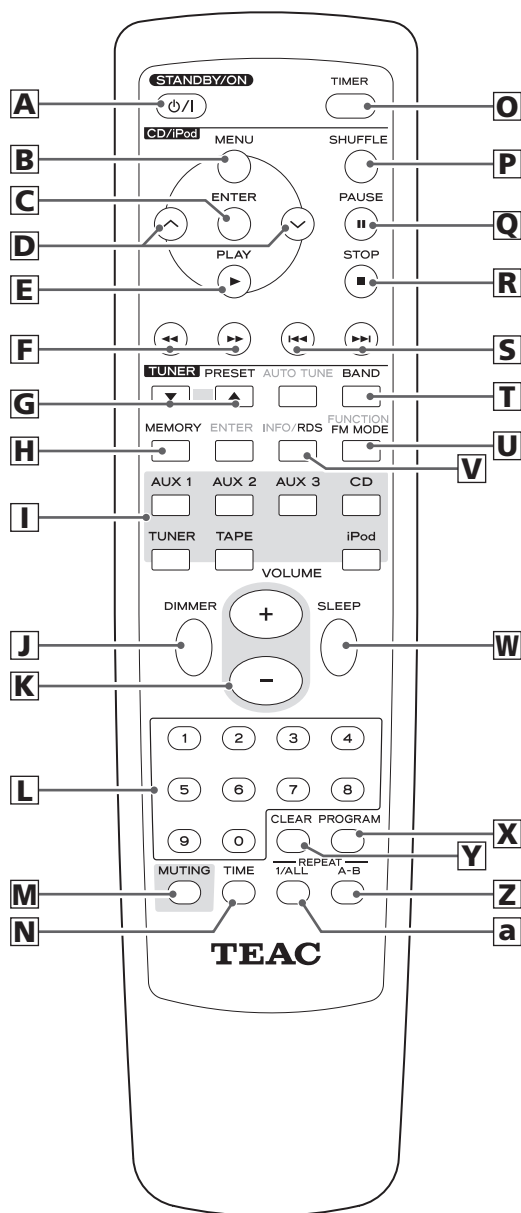

Note:

To simplify explanations, instructions in this manual refer to the names of the buttons and controls on the front panel only. Associated controls on the remote control will also operate similarly.

- Following buttons don't work on the CR-H227i.
FUNCTION, AUTO TUNE, ENTER, INFO

A STANDBY/ON (⏻/⏻)

Press this button to turn the unit on or standby.

B MENU

In iPod mode, use this button to go back to the previous menu. This button is equivalent to the MENU button on your iPod.

During MP3/WMA playback, use this button to display MP3/WMA information.

C ENTER

This button is equivalent to the Center button on your iPod.

In iPod mode, use this button to confirm selection in menus.

D Scroll (⏮ / ⏭)

In iPod mode, use these buttons to scroll up and down the menu.

E PLAY (▶)

In CD or iPod mode, use this button to start playback.

F SEARCH (⏮/▶▶)

In CD or iPod mode, hold down these buttons to search for a part of a track.

G PRESET (▼/▲)

In TUNER mode, use these buttons to select a preset station.

H MEMORY

In TUNER mode, use this button to preset stations.

I SOURCE (AUX 1, AUX 2, AUX 3, CD, TUNER, TAPE, iPod)

Use these buttons to select a source.

J DIMMER

Use this button to dim the display.

K VOLUME

Use these buttons to adjust the volume.

L Numeric buttons

Use these buttons to select a track number or a preset channel.

To use the numeric buttons in CD mode or in TUNER mode, you have to press the CD button or the TUNER button beforehand to switch the function of the remote control unit from TUNER to CD (or from CD to TUNER).

If the remote control unit doesn't work, press the CD button or the TUNER button and try again. (Even when the CD or TUNER button is pressed without pointing at the main unit, the function of the remote control unit will be switched.)

For instance, to select track number 35, first press the CD button, and then press "3" and "5".

To select numbers less than 10, press "0" and then the number. As an example, to select number 2, press "0" and "2". (Optionally, you may press just the number "2" and then wait a few seconds.)

M MUTING

Use this button to mute the sound.

N TIME

During audio CD playback, use this button to change the time display.

O TIMER

Use this button to turn on or off the timer function.

P SHUFFLE

In CD or iPod mode, use this button to turn on and off the shuffle playback.

Q PAUSE (II)

In CD or iPod mode, use this button to pause playback.

R STOP (■)

In CD mode, use this button to stop playback.

- This button doesn't work in iPod mode.

S SKIP (◀◀/▶▶)

In CD or iPod mode, use these buttons to skip tracks.

T BAND

Use this button to select AM or FM.

U FM MODE

In FM TUNER mode, use this button to select stereo

or monaural.

V RDS

In FM TUNER mode, use this button to select an RDS mode.

W SLEEP

Use this button to set sleep timer.

X PROGRAM

In CD mode, use this button to program tracks.

Y CLEAR

Use this button to clear a program.

Z REPEAT A-B

In CD mode, use this button to set the point for A-B repeat.

- This button doesn't work in iPod mode.

a REPEAT 1/ALL

In CD or iPod mode, use this button to set the repeat function.

IMPORTANT

Buttons for CD and iPod

To use the following buttons on the remote control unit in CD mode or in iPod mode, you have to press the CD button or the iPod button beforehand to switch the function of the remote control unit from iPod to CD (or from CD to iPod):

PLAY, PAUSE, SHUFFLE, SKIP, SEARCH,
REPEAT 1/ALL

If the remote control unit doesn't work, press the CD button or the iPod button and try again. (Even when the CD or iPod button is pressed without pointing at the main unit, the function of the remote control unit will be switched.)

For instance, to use shuffle function in CD mode, first press the CD button, and then press the SHUFFLE button.

Remote Control Unit

The provided Remote Control Unit allows the unit to be operated from a distance.

When operating the remote control unit, point it towards the REMOTE SENSOR on the front panel of the unit.

- Even if the remote control unit is operated within the effective range, remote control operation may be impossible if there are any obstacles between the unit and the remote control.
- If the remote control unit is operated near other appliances which generate infrared rays, or if other remote control devices using infrared rays are used near the unit, it may operate incorrectly. Conversely, the other appliances may operate incorrectly.

Battery Installation

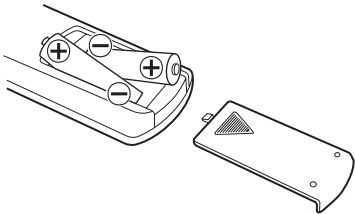

1. Remove the battery compartment cover.
2. Insert two "AAA" (R03, UM-4) dry batteries. Make sure that the batteries are inserted with their positive "⊕" and negative "⊖" poles positioned correctly.
3. Close the cover.

Battery Replacement

If the distance required between the remote control unit and main unit decreases, the batteries are exhausted. In this case replace the batteries with new ones.

Precautions concerning batteries

- Be sure to insert the batteries with correct positive "⊕" and negative "⊖" polarities.
- Use batteries of the same type. Never use different types of batteries together.
- Rechargeable and non-rechargeable batteries can be used. Refer to the precautions on their labels.
- When the remote control unit is not to be used for a long time (more than a month), remove the batteries from the remote control unit to prevent them from leaking. If they leak, wipe away the liquid inside the battery compartment and replace the batteries with new ones.
- Do not heat or disassemble batteries and never dispose of old batteries by throwing them in a fire.

Basic Operation 1

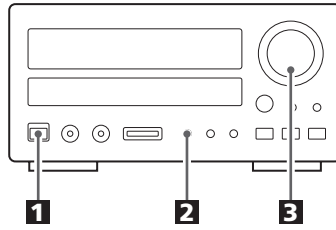

1 Press the **STANDBY/ON** button to turn the unit on.



2 Select a source by pressing the **SOURCE** button.



Each time the **SOURCE** button is pressed, the source changes as follows:

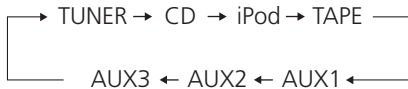

- To listen to an external source connected to the **AUX IN** jack, select **AUX** (1, 2 or 3).
- You can use the **CD**, **iPod**, **TAPE**, **AUX** (1, 2 or 3) or **TUNER** button on the remote control unit to select a source directly.

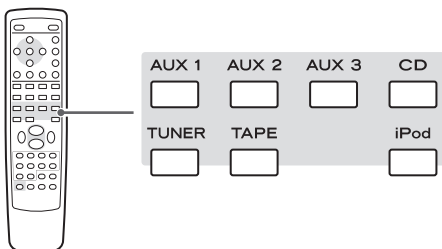

3 Play the source, and gradually turn up the volume to the required level by turning the **VOLUME** knob.

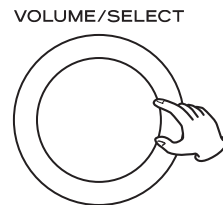

Headphones

For private listening, first reduce the volume level to minimum. Then insert the plug from your headphones into the PHONES jack, and adjust the volume using the VOLUME buttons. The sound from the speakers is cut off while the headphone jack is inserted.

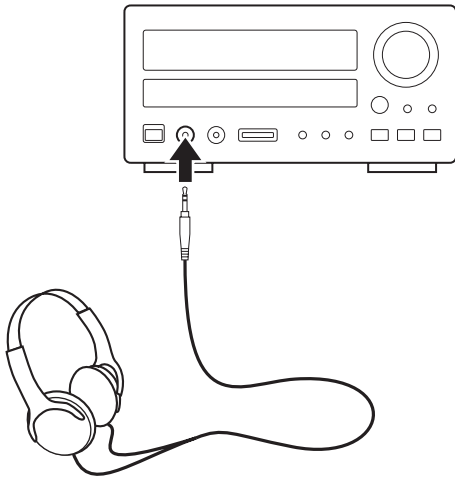

- Subwoofer output will not be cut off, even when the headphone jack is inserted.

CAUTION

Always lower the volume level prior to plugging in your headphones. TO AVOID DAMAGING YOUR HEARING - Do not place your headphones on your head until after you have plugged them in.

Muting

To mute the sound temporarily, press the MUTING button. Press the MUTING button again to restore the sound.

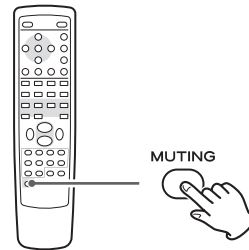

- While muting is engaged, "MUTE" blinks on the display.
- If you change the volume during the muting, the muting will be canceled.

Sleep Timer

The power can be switched off after a specified amount of time.

Press the SLEEP button repeatedly until desired time appears on the display.

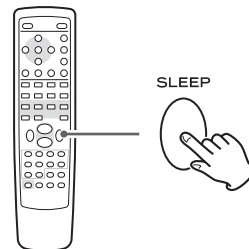

SLEEP 90 (80, 70 ... 10)

The power will be switched off 90 (80, 70 ... 10) minutes later.

(normal display)

The sleep timer is off.

- The display is dimmed when you set the sleep timer.
- If you want to check the remaining time, press the SLEEP button once. The remaining time will be displayed for 3 seconds, and return to the normal display.

How to adjust bass, treble, balance of speakers and dimmer

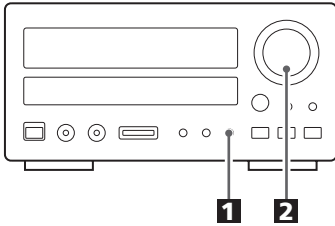

1 Repeatedly press the **TONE/BAL/DIMMER** button to select the menu item to be changed.

TONE/BAL/
DIMMER

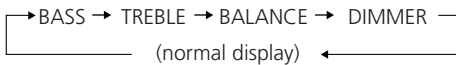

2 Within 3 seconds, turn the **VOLUME/SELECT** knob to change the setting.

VOLUME/SELECT

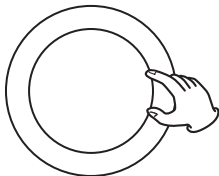

3 Leave the unit idle for 3 seconds to exit the setup mode.

Available menu item and options

BASS

Adjusts the level of low frequency sound range. The level can be adjusted from -10 to +10.

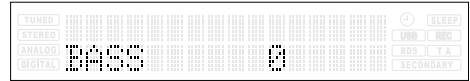

TREBLE

Adjusts the level of high frequency sound range. The level can be adjusted from -10 to +10.

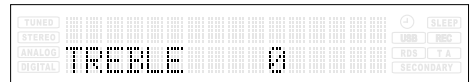

BALANCE

Adjusts the balance of the volume level between left and right speakers.

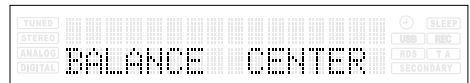

DIMMER

Turns on or off the dimmer function. Select "ON" to dim the display.

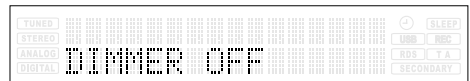

- This function will be cancelled when the unit is turned off.
- You can also use the DIMMER button of the remote control unit to turn on or off the dimmer function.

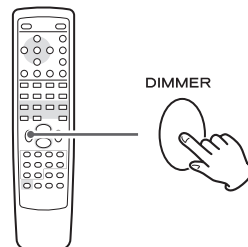

Getting started with iPod

The CR-H227i comes mounted with an adapter for iPod with color display (40GB, 60GB), "60GB (color) + Photo 40GB/60GB". To play your iPod through the CR-H227i, you have first to check if the factory mounted adapter fits your model of iPod. If it does not, you have to replace it with a correct one, as explained below.

1. Remove the adapter from the Dock of the CR-H227i.

Hold the left and right sides of the adapter and gently pull it up.

2. Choose the Dock adapter that fits your iPod mobile digital device.

"Video 30GB" for iPod with video (30 GB).

"Video 60GB/80GB" for iPod with video (60 GB, 80 GB).

"nano" for iPod nano.

"mini" for iPod mini.

"20GB (color) + Photo 30GB" for iPod with color display (20GB, 30GB, U2 Special Edition).

"60GB (color) + Photo 40GB/60GB" for iPod with color display (40GB, 60GB).

"20GB + U2" for iPod with Click Wheel (20 GB, U2 Special Edition).

"40GB" for iPod with Click Wheel (40 GB).

- Use a commercially available adapter to play iPod with dock connector (with four buttons under the display).

3. Insert the adapter into the Dock of the CR-H227i.

Fit the front edge of the adapter into the Dock, and then press the back edge of the adapter onto the Dock until a slight "click" is heard indicating the adapter is inserted correctly.

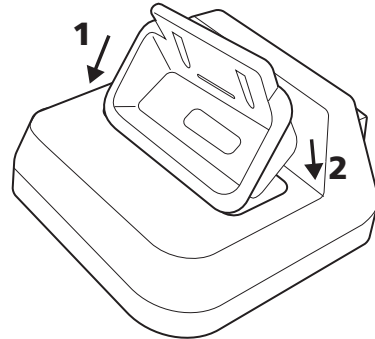

- When you need to remove the adapter, hold the left and right sides of the adapter and gently pull it up.
- When you don't use the Dock, use the supplied cover for the Dock to prevent dust from settling on the Dock.

Compatible iPod Software

In case your iPod will not work with the CR-H227i or with the remote control unit, software update may solve the problem.

Visit the Apple website and download the latest iPod Software.

iPod is a trademark of Apple Computer, Inc., registered in the U.S. and other countries.

Listening to iPod 1

- 1 Press the iPod button of the remote control unit (or repeatedly press the SOURCE button) to select "iPod".

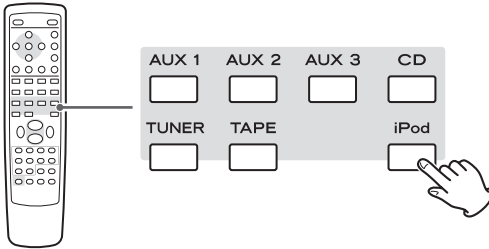

If no iPod is docked, "Unplugged" appears on the display.

If an iPod is already docked, playback will start.

- 2 Insert the iPod into the Dock of the CR-H227i.

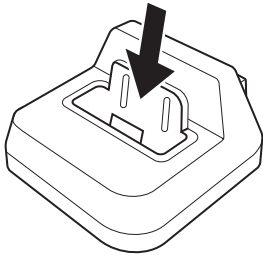

"The iPod is connected" briefly appears on the display.

The iPod automatically turns on and starts playback from the iPod's music list.

- Make sure to use an appropriate Dock adapter (see "Getting started with iPod" on page 22).
- The iPod battery will be fully recharged when the iPod is docked and the CR-H227i is connected to the AC power supply.
- When headphones are plugged into the iPod, sound comes from both the speakers of the CR-H227i and the headphones.
- The STOP button (■) of the remote control unit doesn't work in iPod mode.

To start or pause playback

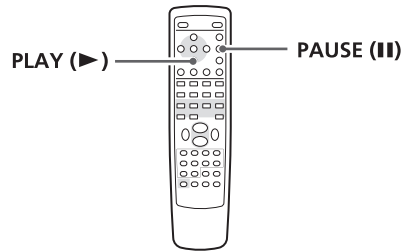

In iPod mode, press the PLAY button (▶) to start playback.

During playback, press the Pause button (||) to pause playback. Playback stops at the current position. To resume playback, press the PLAY button (▶) or the Pause button (||).

- Following buttons on the main unit don't work in the Click Wheel mode:

PLAY, PAUSE, SKIP

IMPORTANT

Buttons for CD and iPod

To use the following buttons on the remote control unit in CD mode or in iPod mode, you have to press the CD button or the iPod button beforehand to switch the function of the remote control unit from iPod to CD (or from CD to iPod):

PLAY, PAUSE, SHUFFLE, SKIP, SEARCH,
REPEAT 1/ALL

If the remote control unit doesn't work, press the CD button or the iPod button and try again. (Even when the CD or iPod button is pressed without pointing at the main unit, the function of the remote control unit will be switched.)

For instance, to use shuffle function in CD mode, first press the CD button, and then press the SHUFFLE button.

Display mode (Video output from iPod)

When the iPod is docked, press and hold the MENU button for more than 3 seconds to select which display to be used.

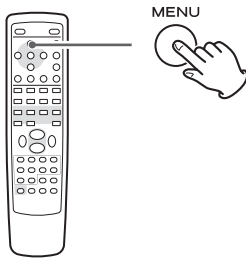

Extended mode (default)

Select this to use the display of the CR-H227i. Information on the audio files is displayed on the display of the CR-H227i. The screen of the iPod shows TEAC logo.

- No signal is output from the S-VIDEO and VIDEO terminals.

Click Wheel Mode

Select this to use the screen of the iPod. Menu appears on the screen of the iPod. The display of the CR-H227i constantly shows "Clickwheel Mode".

- When the Dock is connected to a TV or monitor, select "Click Wheel Mode" to output video signals.
- Following buttons on the main unit don't work in the Click Wheel mode:
PLAY, PAUSE, SKIP

To skip to the next or a previous track

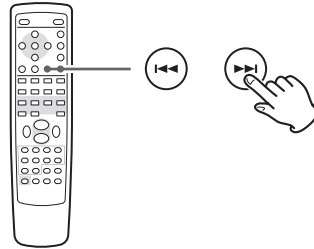

During playback, press the SKIP button (I◀◀ or ▶▶I) repeatedly until the desired track is found. The selected track will be played from the beginning.

- When the I◀◀ button is pressed during playback, the track being played will be played from the beginning. To return to the beginning of the previous track, press the I◀◀ button twice.

Search for a part of a track

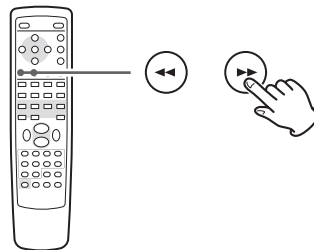

During playback, hold down the SEARCH button (◀◀ or ▶▶) of the remote control unit (or the SKIP button of the main unit) for more than 2 seconds and release it when the part you want to listen to is found.

To go back to the previous menu

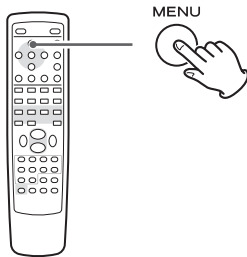

Press the MENU button to go back to the previous menu.

This button is equivalent to the MENU button on your iPod.

Select the menu item

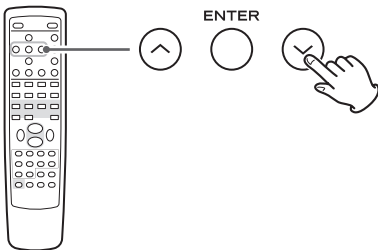

Press the scroll button (\wedge or \vee) of the remote control unit (or the SKIP button of the main unit) to scroll to the menu item you want, and then press the ENTER button.

To activate the repeat mode

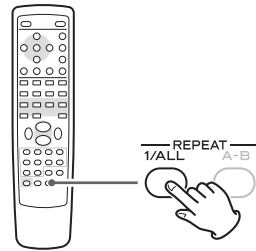

During playback, press the REPEAT button to change the repeat mode.

Each time the REPEAT button is pressed, the REPEAT setting of iPod is changed as follows:

Repeat 1, Repeat All, (off)

- In the Click Wheel mode, if the iPod is set to repeat one song, the Repeat One icon (↺) appears in the iPod's display.
In the Click Wheel mode, if the iPod is set to repeat all songs, the Repeat icon (↻) appears in the iPod's display.

To activate the shuffle mode

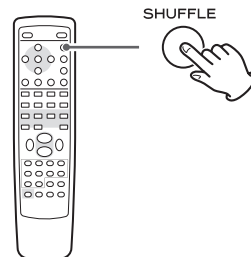

During playback, press the SHUFFLE button to change the shuffle mode.

Each time the SHUFFLE button is pressed, the SHUFFLE setting of iPod is changed as follows:

Shuffle Songs, Shuffle Albums, (off)

- In the Click Wheel mode, if iPod is set to shuffle songs or albums, the Shuffle icon (∞) appears in the iPod's display.

Listening to CD/MP3/WMA 1

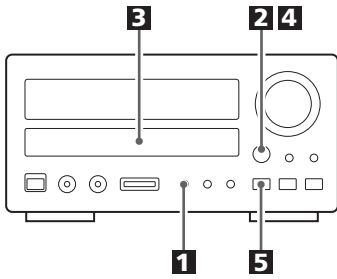

- 1** Press the CD button of the remote control unit (or repeatedly press the SOURCE button) to select "CD".

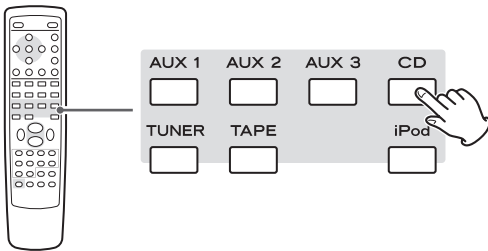

"No Disc" will be displayed if no disc is set.

- 2** Press the OPEN/CLOSE button (▲).

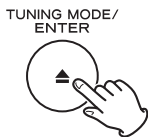

- 3** Place a disc on a tray with the printed surface up.

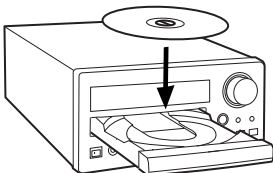

- 4** Press the OPEN/CLOSE button (▲) to close the tray.

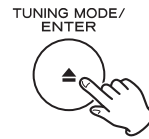

When an audio CD is loaded:

The total number of the tracks and total play time of the disc is displayed.

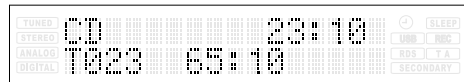

When an MP3 or WMA disc is loaded:

The total number of files of the disc is displayed.

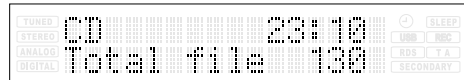

- 5** Press the PLAY button (▶).

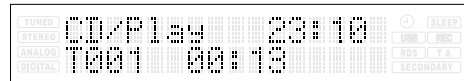
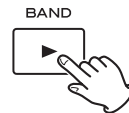

Playback starts from the first track/file.

- When a disc is on the disc tray, selecting the CD mode will start playback.
- If the source is set to "CD", the unit will automatically start playback when you turn on the unit next time.
- File types that can be played on this unit: MP3, WMA

IMPORTANT

Buttons for CD and iPod

To use the following buttons on the remote control unit in CD mode or in iPod mode, you have to press the CD button or the iPod button beforehand to switch the function of the remote control unit from iPod to CD (or from CD to iPod):

PLAY, PAUSE, SHUFFLE, SKIP, SEARCH,
REPEAT 1/ALL

If the remote control unit doesn't work, press the CD button or the iPod button and try again. (Even when the CD or iPod button is pressed without pointing at the main unit, the function of the remote control unit will be switched.)

For instance, to use shuffle function in CD mode, first press the CD button, and then press the SHUFFLE button.

Numeric buttons for CD and TUNER

To use the numeric buttons in CD mode or in TUNER mode, you have to press the CD button or the TUNER button beforehand to switch the function of the remote control unit from TUNER to CD (or from CD to TUNER).

If the remote control unit doesn't work, press the CD button or the TUNER button and try again. (Even when the CD or TUNER button is pressed without pointing at the main unit, the function of the remote control unit will be switched.)

To suspend playback temporarily (pause mode)

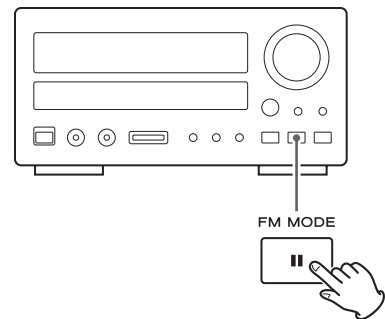

Press the Pause button (■) during playback. Playback stops at the current position. To resume playback, press the PLAY button (▶) or the Pause button (■).

To stop playback

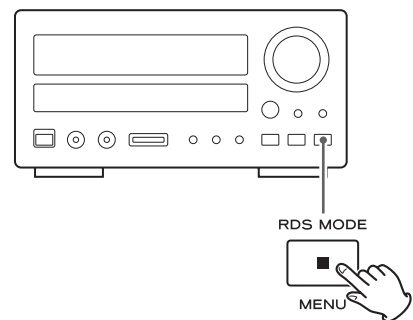

Press the STOP button (■) to stop playback.

Listening to CD/MP3/WMA 2

Search for a part of a track

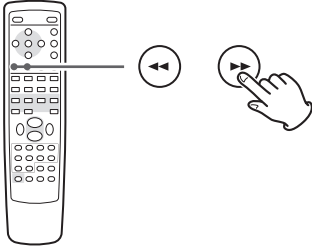

During playback, hold down the SEARCH button (◀◀ or ▶▶) of the remote control unit (or the SKIP button of the main unit) for more than 2 seconds and release it when the part you want to listen to is found.

To skip to the next or a previous track

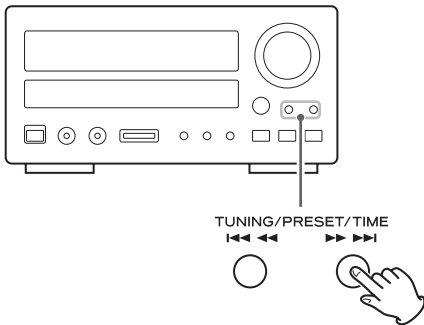

During playback, press the SKIP button (I◀◀ or ▶▶I) repeatedly until the desired track is found. The selected track will be played from the beginning.

In the stop mode, press the SKIP button (I◀◀ or ▶▶I) repeatedly until the track you want to listen to is found. Press the PLAY button (▶) to start playback from the selected track.

- When the I◀◀ button is pressed during playback, the track being played will be played from the beginning. To return to the beginning of the previous track, press the I◀◀ button twice.
- During programmed playback, the next or previous track in the program is played.

Direct Playback (CD/MP3/WMA)

While in stop or playback mode, you can use the numeric buttons of the remote control to select a track.

When you use the numeric buttons, press the CD button of the remote control first.

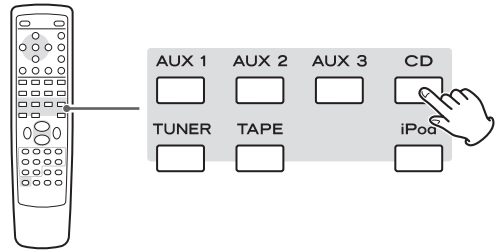

Press the numeric buttons to select a track. Playback starts from the selected track.

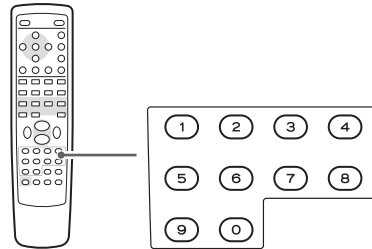

For instance, to select track number 35, press "3" and "5".

To select numbers less than 10, press the number and then the ENTER button. As an example, to select number 5, press "5" and the ENTER button. (Optionally, you may press just the number "5" and then wait a few seconds.)

Repeat Playback (CD/MP3/WMA)

Repeat Playback

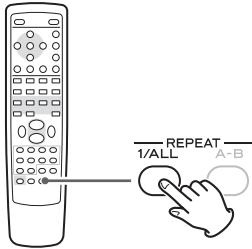

Each time the REPEAT 1/ALL button is pressed, the mode is changed as follows:

When a CD is loaded:

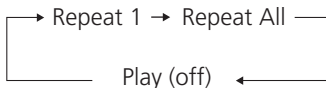

When an MP3/WMA disc is loaded.

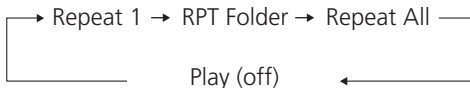

- If one of the following buttons is pressed, repeat mode will be canceled:
STOP, SOURCE (AUX, TUNER, TAPE, iPod),
BAND, OPEN/CLOSE, STANDBY/ON

Repeat one track (Repeat 1)

The track being played will be played repeatedly. If you press the SKIP button (◀◀ or ▶▶) and select another track, the track you selected will be played repeatedly.

It is also possible to select a track to be repeated in the stop mode. Press the REPEAT 1/ALL button and select a track using the numeric buttons.

Repeat all the tracks in the folder (RPT Folder) (MP3/WMA only)

All the tracks in the folder will be played repeatedly.

- This mode is not available in the stop mode.
- When the disc has no folder, this mode will be skipped.

Repeat all the tracks (Repeat All)

All the tracks will be played repeatedly.

During programmed playback, programmed tracks will be played repeatedly.

A-B Repeat Playback

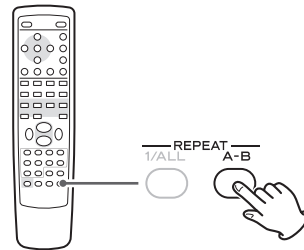

This function allows repeat playback of any desired portion of the disc.

1. Designate the point at which repeat playback should start by pressing the A-B button.

"Repeat A-" lights up and "B" blinks.

2. When the point at which repeat playback should end is reached, press the A-B button again.

"Repeat A-B" lights up.

The designated point with A-B button will be played back repeatedly.

- To return to normal play, press A-B button until "Repeat A-B" disappears from the display.
- There must be more than 3 seconds between A and B.

Programmed Playback (CD/MP3/WMA)

Up to 32 tracks can be programmed in the desired order.

1 Press the PROGRAM button in the stop mode.

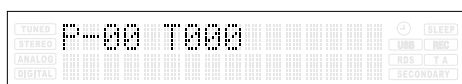
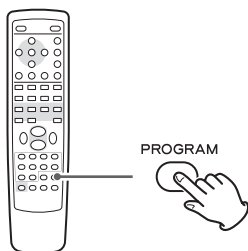

2 Select a track using the numeric buttons.

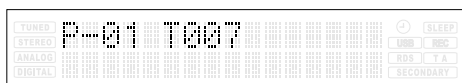
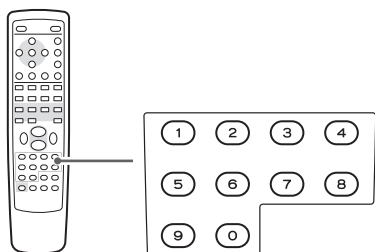

- If the numeric buttons don't work, first press the CD button, and then press the number.
- You can also use the SKIP button and the PROGRAM button to program tracks. Select a track using the SKIP button (◀◀ or ▶▶), and within 5 seconds press the PROGRAM button.

Repeat this step to program more tracks.

- If you made a mistake, press the CLEAR button. The last programmed number will be deleted.
- Up to 32 tracks can be programmed. If you attempt to program more than 32 tracks, "P-FULL (Program is full)" is displayed and no more can be programmed.

3 When programming has been finished, press the PLAY button (▶) to start programmed playback.

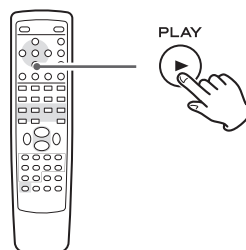

When the playback of all the programmed tracks has finished, or if the STOP button or the STANDBY/ON button is pressed, the program mode will be cancelled.

But the programmed contents aren't lost. You can return to the programmed playback by pressing the PROGRAM button and the PLAY button (▶).

- If the disc tray is opened or the power cord is unplugged, the programmed contents will be erased.

To check the programmed order

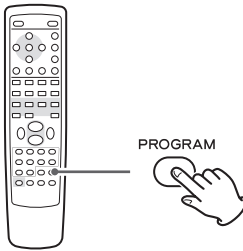

In the stop mode, press the PROGRAM button repeatedly. The track number and program number will be shown on the display.

To add a track to the program

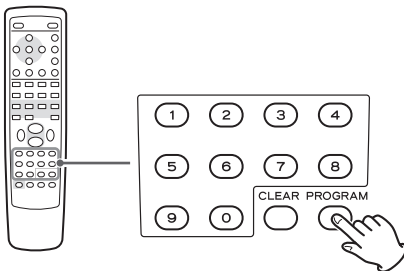

In the stop mode, press the PROGRAM button repeatedly until the program number you want to insert a track appears on the display. If you want to add a track to the end of the program, press the PROGRAM button repeatedly until "P-End" briefly appears on the display.

Then select a track number using the numeric buttons. The track is added to the program.

To delete a track from the program

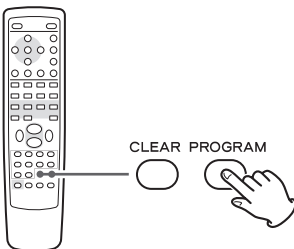

In the stop mode, press the PROGRAM button repeatedly until the program number to be deleted appears on the display, then press the CLEAR button. The selected track/file is deleted from the program.

To clear the program

1. In the stop mode, press the PROGRAM button.

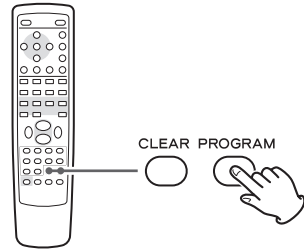

2. Hold down the CLEAR button for more than 4 seconds.

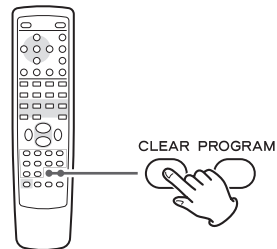

- If one of the following buttons is pressed, the programmed contents will also be cleared:
SOURCE (AUX, TUNER, TAPE, iPod),
OPEN/CLOSE (▲), BAND
- If the unit is disconnected from the power supply, the programmed contents will be cleared.

Shuffle Playback (CD/MP3/WMA)

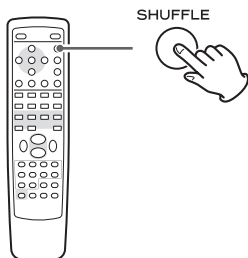

Press the **SHUFFLE** button in the stop or play mode.

“Random play” appears on the display, and the tracks will be played randomly.

- If you press the **▶▶** button during shuffle playback, next track will be randomly selected and played. If you press the **◀◀** button, the currently played track/file will be played from the beginning. A track/file cannot be replayed during shuffle playback.
- To stop shuffle playback, press the SHUFFLE button or the STOP button (■).

Time Display (CD)

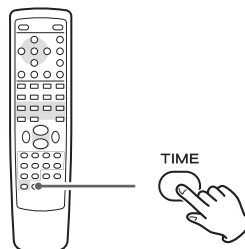

When playing back an audio CD, each time the TIME button is pressed the display changes as follows:

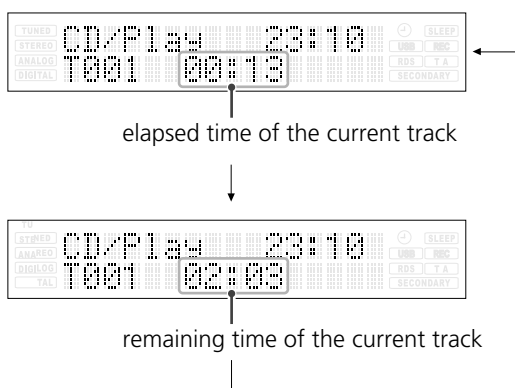

Display (MP3/WMA)

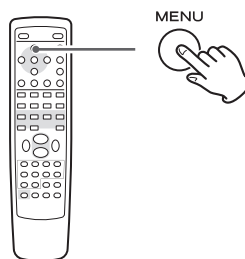

Each time you press the **MENU** button of the remote control unit during playback of MP3 or WMA, the display changes as follows:

Default display (Title, artist and album scroll.), track number, file name, title, artist, album, **date**, comment

Listening to the Radio

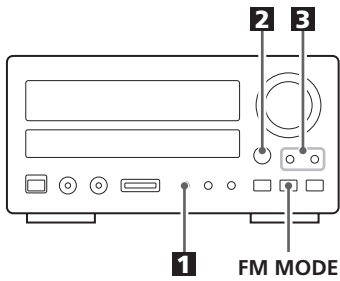

- 1 Press the TUNER button of the remote control unit (or repeatedly press the SOURCE button) to select "TUNER".**

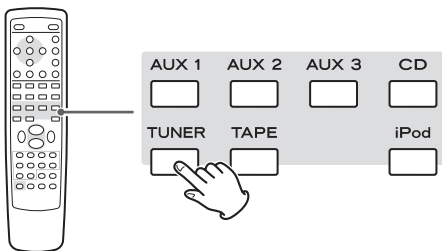

- You can also use the BAND button or the remote control unit to select "TUNER".

- 2 Select AM or FM by pressing the BAND button.**

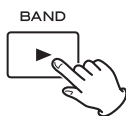

- 3 Press the TUNING MODE button to select the tuning mode.**



Each time the TUNING MODE button is pressed, the tuning mode changes as follows:

Manual tune, Auto tune, Preset tune

Select "Manual tune" or "Auto tune".

- 4 Press the TUNING button to tune in a station.**

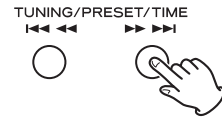

In the Auto tune mode, the unit starts searching for a station. When a station is tuned in, the tuning process will stop automatically.

Repeat this step until the station you want to listen to is found.

- If you want to stop the tuning process, press the TUNING button.

In the Manual tune mode, the frequency changes by a fixed step. Repeatedly press (or hold down) the TUNING button until the station you want to listen to is found.

- The "TUNED" indicator lights when a station is correctly tuned in.

If the reception is poor

Rotate or relocate the antenna to find the best position for reception.

FM MODE Button

Pressing this button alternates between Stereo mode and Mono mode.



Stereo

FM stereo broadcasts are received in stereo and the "STEREO" indicator lights in the display.

- If the sound is distorted and the "STEREO" indicator flashes, the signal is not strong enough for good stereo reception. In this case, change to Mono mode.

Mono

To compensate for weak FM stereo reception, select this mode. Reception will now be forced to monaural, reducing unwanted noise.

Preset Tuning

You can store up to 30 FM and 30 AM stations.

Preset Automatically

1 Select AM or FM by pressing the **BAND** button.

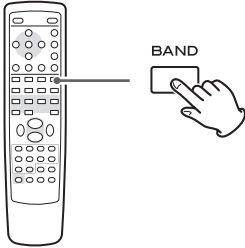

2 Press the **MEMORY** button for more than 3 seconds.

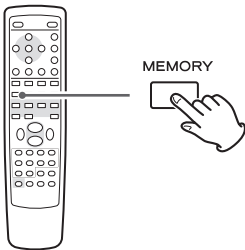

Up to 30 of the best received stations in your area will be stored automatically.

Preset Manually

1 Tune in a station you want to listen to (see page 33).

2 Press the **MEMORY** button.

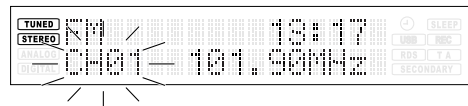
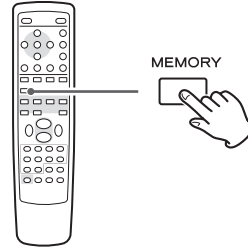

"CH01" blinks on the display.

3 Within 4 seconds, select a preset channel to store the station using the **PRESET** buttons, and then press the **MEMORY** button.

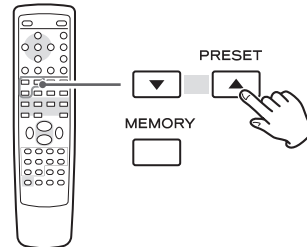

- If you don't press the **MEMORY** button within 4 seconds after selecting the channel, the selection will be canceled.

- You can also use the numeric buttons.
For instance, to select preset number 25, first press the TUNER button, and then press "2" and "5".

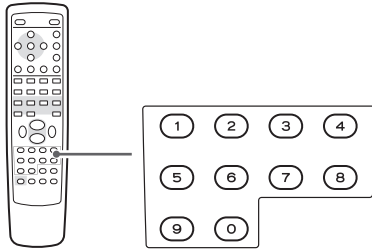

To select numbers less than 10, press "0" and then the number. As an example, to select number 2, press "0" and "2". (Optionally, you may press just the number "2" and then wait a few seconds.)

To store more stations, repeat steps 1 to 3.

- If you store a new station to a channel, the station previously stored in the channel will be overwritten.

How to select preset stations

- 1** Select AM or FM by pressing the BAND button.

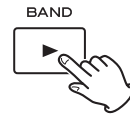

- 2** Select "Preset tune" using the TUNING MODE button.

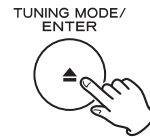

- 3** Select a preset channel using the PRESET buttons or the numeric buttons.

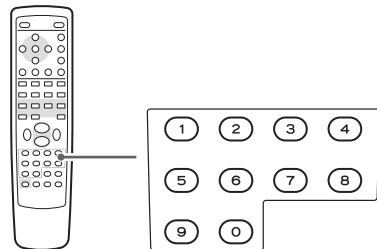
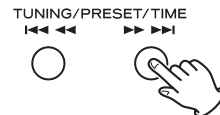

- If the numeric buttons don't work, first press the TUNER button, and then press the number.
- When using the numeric buttons, you can skip step 2.

The Radio Data System (RDS) is a broadcasting service which allows stations to send additional information along with the regular radio programme signal.

RDS works on the FM waveband in Europe only.

1 Tune in an FM RDS station (see page 33).

2 Press the RDS MODE button (or the INFO/RDS button of the remote control unit).

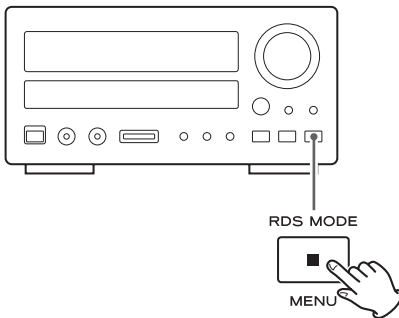

Each time the RDS MODE button is pressed briefly, the RDS mode is changed as follows:

Program service (PS)

When you select Program service, "PROGRAM SERVICE" will blink for about 3 seconds and then the programme service name or a station's name will be displayed. If there is no programme service data, the frequency will be displayed.

RDS Clock time (CT)

Displays the information about times provided from the station.

When you select RDS Clock time, "RDS CLOCK TIME" will blink for about 3 seconds and then the clock time will be displayed.

RDS Program type (PYT)

When you select RDS Program type, "RDS PROGRAM TYPE" will blink for about 3 seconds and then the programme type will be displayed.

RDS Radio text (RT)

When you select RDS Radio text, "RDS RADIO TEXT" will blink for about 3 seconds and then the news of stations composed of up to 64 symbols will be displayed.

Traffic announce (TA)

When you select Traffic announce, "TRAFFIC ANNOUNCE" will blink for 3 seconds and then the unit searches for a traffic announcement.

- When a traffic programme is found, the Traffic announce mode is switched to Program service mode.

If the station currently selected is transmitting a traffic program signal, the RDS mode will be switched to Program service mode without searching for a traffic program.

If there is no CT/PTY/RT data, RDS mode will be automatically switched to PS mode.

The clock setting will be automatically adjusted according to the CT data.

If you tune in an RDS station broadcasting incorrect CT data, the clock might be wrongly adjusted, and that may eventually affect the timer operation.

No matter which RDS mode is selected, the unit receives CT data and adjusts the clock.

To turn on or off the CT mode, press and hold the RDS MODE button for more than 10 seconds.

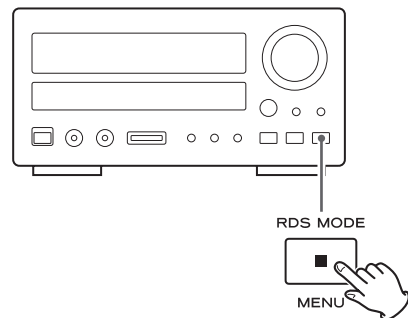

RDS (PTY Search)

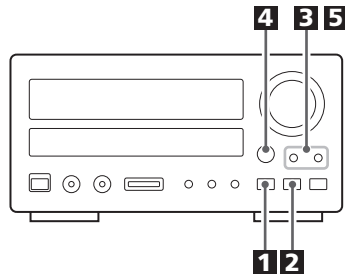

A station can be searched by this function.

1 Select FM by pressing the BAND button.



2 Press the RDS MODE button for more than 3 seconds.

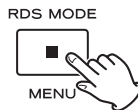

"RDS PROGRAM TYPE" appears on the display.

3 Select the desired programme type using the TUNING button.

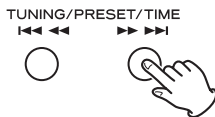

You can select from 31 kinds.
The programme type blinks.

4 Press the ENTER button.



The programme type stops blinking.

5 Press the TUNING button.

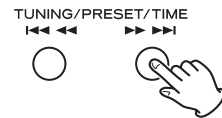

The unit starts searching.

- When the programme that you have selected is found, searching stops and the programme type will be displayed.
- If the same programme type is not found during PTY Search, it will stop at the beginning frequency.
- If you want to stop searching, press the RDS MODE button.

News:

brief announcements, events, public opinion, reports, actual situations.

Current Affairs:

a kind of suggestion including practical announcements other than news, documents, discussion, analysis and so on.

Information:

daily information or reference such as weather forecast, consumer guide, medical assistance and so on.

Sport:

sports related programs.

Education:

educational and cultural information.

Drama:

all kinds of radio concert and serial drama.

Cultures:

all aspects of national or local culture including religious events, philosophy, social science, language, theatre, and so on.

Science:

programs on natural science and technology

Varied Speech:

popular programs such as quiz, entertainment, private interview, comedy, satire and so on.

Pop Music:

program on commercial, practical and popular songs, and sale volume of discs, etc.

Rock Music:

practical modern music generally composed and played by young musicians.

Easy Listening:

popular music usually lasting for less than 5 minutes.

Light Classics M:

classical music, instrumental music, chorus, and light music favored by non-professionals.

Serious Classics:

orchestra including great operas, symphony, chamber music and so on.

Other Music:

other music styles (Rhythm & Blues, Reggae, etc.)

Weather & Metr:

weather reports, forecast

Finance:

financial reports, commerce, trading

Children's Progs:

children's programs

Social Affairs:

social affairs

Religion:

religious programs

Phone In:

program in which the public expresses its view by phone.

Travel & Touring:

travel reports

Leisure & Hobby:

programs concerning recreational activities

Jazz Music:

jazz music

Country Music:

country music

National Music:

national music

Oldies Music:

music from the so-called golden of popular music

Folk Music:

folk music

Documentary:

documentaries

Alarm Test**Alarm-Alarm!:**

a program notifying an emergency or a natural disaster.

Setting the Clock

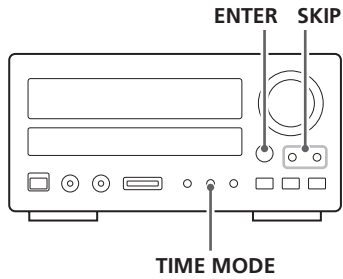

1 Press the TIME MODE button once.



Each time the TIME MODE button is pressed, the mode is changed as follows:

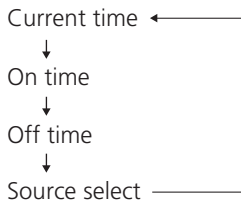

- When no action is taken for 1 minute, the time adjust mode will be cancelled.
- Press the STOP button to cancel the time setting.

2 Press the SKIP buttons to set the current hour.

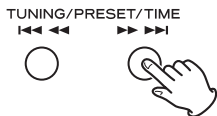

3 Press the ENTER button.

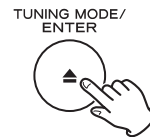

The "minute" value blinks.

4 Press the SKIP buttons to set the current minute.

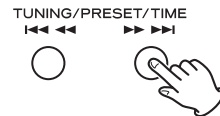

5 Press the ENTER button.

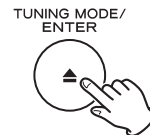

The clock starts from 00 seconds.

Setting the Timer

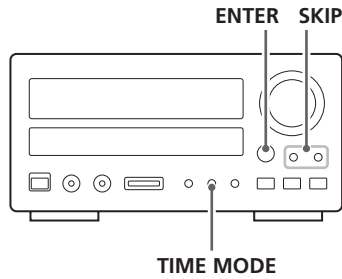

Setting the Timer

- The unit can be programmed to turn on and off at a specified time.
- Adjust the clock before setting the timer.
- When no action is taken for 1 minute, the timer setting mode will be cancelled.

1 Press the TIME MODE button twice.



"On time" appears on the display, and the "hour" value blinks.

2 Press the SKIP buttons to set the start time (hour), and press the ENTER button.

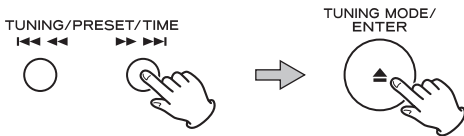

The "minute" value blinks.

3 Press the SKIP buttons to set the start time (minute), and press the ENTER button.

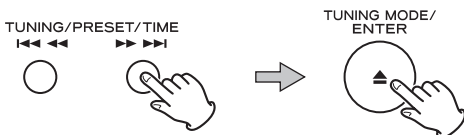

"Off time" appears on the display, and the "hour" value blinks.

4 Press the SKIP buttons to set the stop time (hour), and press the ENTER button.

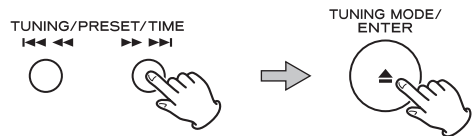

The "minute" value blinks.

5 Press the SKIP buttons to set the stop time (minute), and press the ENTER button.

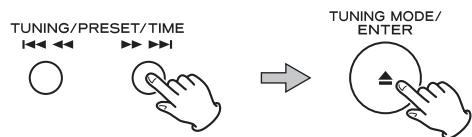

"Source select" appears on the display.

6 Press the SKIP buttons to select a source, and press the ENTER button.

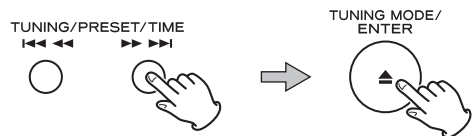

Now the timer setting is stored in memory.

To turn on the timer

- 1 After setting the timer, press the **TIMER** button to turn the timer on.

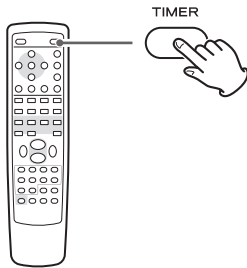

The timer indicator "⊕" lights on the display.

- 2 Prepare the source and adjust the volume.

When the source is set to "iPod", insert an iPod.

When the source is set to "CD", set a disc.

When the source is set to "TUNER", tune in a station.

- 3 Press the **STANDBY/ON** button to turn the unit off (standby).

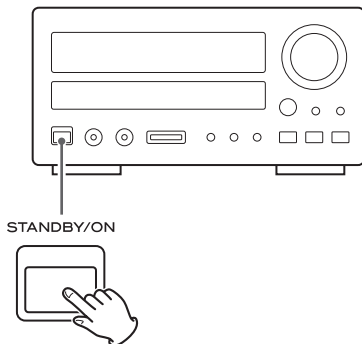

The standby indicator surrounding the **STANDBY/ON** button blinks at 5-second intervals.

The unit will turn on and off at the specified time every day.

Don't forget to turn the unit off (standby), or the timer won't work.

- When the source is set to "TUNER" and the unit turns on, it will tune in to the station you selected last time.

To turn off the timer

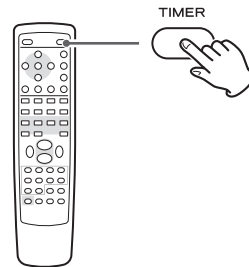

When you don't use the timer, press the **TIMER** button to turn it off. (The timer indicator "⊕" disappears from the display.)

Press the **TIMER** button again to turn it on.

To check the timer setting

Repeatedly press the **TIME MODE** button to check the timer setting.

If you have problems with your system, look through this chart and see if you can solve the problem yourself before calling your dealer or TEAC service center.

General

No power

- Check the connection to the AC power supply. Check and make sure the AC source is not a switched outlet and that, if it is, the switch is turned on. Make sure there is power to the AC outlet by plugging another item such as a lamp or fan into the outlet.

No sound from speakers.

- Select the source by pressing the SOURCE button.
- Check the connection to the speakers.
- Adjust the volume.
- Pull out the headphone's plug from the PHONES jack.
- If "MUTE" is blinking, press the MUTING button.

The sound is noisy.

- The unit is too close to a TV or similar appliances. Install the unit apart from them, or turn them off.

Remote control doesn't work.

- Press the STANDBY/ON switch to turn the unit on.
- If the batteries are dead, change the batteries.
- Use remote control unit within the range (5m or 16 ft.) and point at the front panel.
- Clear obstacles between the remote control unit and the main unit.
- If a strong light is near the unit, turn it off.

CD Player

Will not play.

- Load a disc with label side up.
- If the disc is dirty, clean the surface of the disc.
- A blank disc has been loaded. Load a prerecorded disc.
- Depending on the disc, etc. it may not be possible to play back CD-R/RW discs. Try again with another disc.
- You cannot play back unfinalized CD-R/RW discs. Finalize such a disc in a CD recorder and try again.

Sound skips.

- Place the unit on a stable place to avoid vibration and shock.
- If the disc is dirty, clean the surface of the disc.

- Don't use scratched, damaged or warped discs.

MP3/WMA

There is no sound even if the PLAY button (▶) is pressed.

- Check the file format. Non-playable file formats (e.g MPEG 1 LAYER 2 file) cannot be played.

"No song title No artist No album" appears on the display.

- There is no ID3 tag information for the music file. Edit the song title, artist, and album information of the song on a PC using the MP3 or WMA making application.

Some unknown characters are displayed on the display panel.

- This unit cannot display symbols and full-size or double-byte characters (such as Japanese, Chinese, etc.) correctly. File name of MP3 or WMA should be alphanumeric characters.

iPod Player

Cannot insert the iPod.

- Check the dock adapter.
- Remove dust or obstacles from the Dock connector of the CR-H227i and the iPod, and insert the iPod again.

Will not play.

- Remove the iPod from the dock, wait a few seconds, and insert it again.
- Software update may solve the problem. Visit the Apple website and download the latest iPod Software.

Tuner

Cannot listen to any station, or signal is too weak.

- Tune in the station properly.
- Rotate the FM or AM antenna for the best reception position.
- An external antenna is recommended.

Though the broadcast is stereo, it sounds monaural.

- Press the FM MODE button.

If normal operation cannot be recovered, unplug the power cord from the outlet and plug it again.

Specifications

AMPLIFIER Section

Output Power25 W/ch (6 ohms, 0.5 %, 1 kHz)
Input Sensitivity 400 mV/47 kohms
Frequency Response
20 Hz to 60,000 Hz (+1/-3 dB)

TUNER Section

FM Section

Tuning Range 87.50 MHz to 108.00 MHz
(50 kHz steps)
Signal-to-Noise Ratio 65 dB (Mono)
60 dB (Stereo)
Presets 30

AM Section

Tuning Range 522 kHz to 1629 kHz
(9 kHz steps)
Signal-to-Noise Ratio 35 dB
Presets 30

CD Player Section

Frequency Response . . . 20 Hz to 20,000 Hz (± 2 dB)
Signal-to-Noise Ratio more than 95 dB
Wow and Flutter Unmeasurable

General

Power Requirements 230 V AC, 50 Hz
Power Consumption 75 W
1.5 W (standby)

Dimension (W x H x D)

Main unit. 215 x 110 x 359 mm
Dock (without cable) 100 x 40 x 106 mm

Weight

Main unit 4.4 kg
Dock 0.4 kg

Standard Accessories

Remote Control Unit x 1
Batteries (AAA) x 2
AM Loop Antenna x 1
FM Lead-type Antenna x 1

Dock x 1

Dock adapter x 8
(adapter "60GB (color) + Photo 40GB/60GB"
premounted)
Cover for the Dock x 1

Owner's Manual x 1
Warranty Card x 1

- Design and specifications are subject to change without notice.
- Weight and dimensions are approximate.
- Illustrations may differ slightly from production models.

Free Manuals Download Website

<http://myh66.com>

<http://usermanuals.us>

<http://www.somanuals.com>

<http://www.4manuals.cc>

<http://www.manual-lib.com>

<http://www.404manual.com>

<http://www.luxmanual.com>

<http://aubethermostatmanual.com>

Golf course search by state

<http://golfingnear.com>

Email search by domain

<http://emailbydomain.com>

Auto manuals search

<http://auto.somanuals.com>

TV manuals search

<http://tv.somanuals.com>