

TEAC

MC-DX220i

Micro Hi-Fi System

OWNER'S MANUAL

TEAC



Includes adapters for:

- iPod nano
- iPod with video
- iPod mini
- iPod with Click Wheel
- iPod with color display

Adapters sold separately:

- iPod with dock connector

TEAC CORPORATION	3-7-3, Nakacho, Musashino-shi, Tokyo 180-8550, Japan Phone: (0422) 52-5081
TEAC AMERICA, INC.	7733 Telegraph Road, Montebello, California 90640 Phone: (323) 726-0303
TEAC CANADA LTD.	5939 Wallace Street, Mississauga, Ontario L4Z 1Z8, Canada Phone: (905) 890-8008
TEAC MEXICO, S.A. De C.V	Campeños N°184, Colonia Granjas Esmeralda, Delegacion Iztapalapa, CP 09810, México DF Phone: (525) 581-5500
TEAC UK LIMITED	Unit 19 & 20, The Courtyards, Hatters Lane, Watford, Hertfordshire, WD18 8TE, U.K. Phone: (0845) 130-2511
TEAC EUROPE GmbH	Bahnstrasse 12, 65205 Wiesbaden-Erbenheim, Germany Phone: 0611-71580
TEAC AUSTRALIA PTY., LTD.	30 Tullamarine Park Road, Tullamarine, VIC 3043, Australia Phone: (03) 8336-6500 A.B.N. 11 113 998 048

This appliance has a serial number located on the rear panel. Please record the model number and serial number and retain them for your records.

Model number _____ Serial number _____

0806-MA-1110A UK

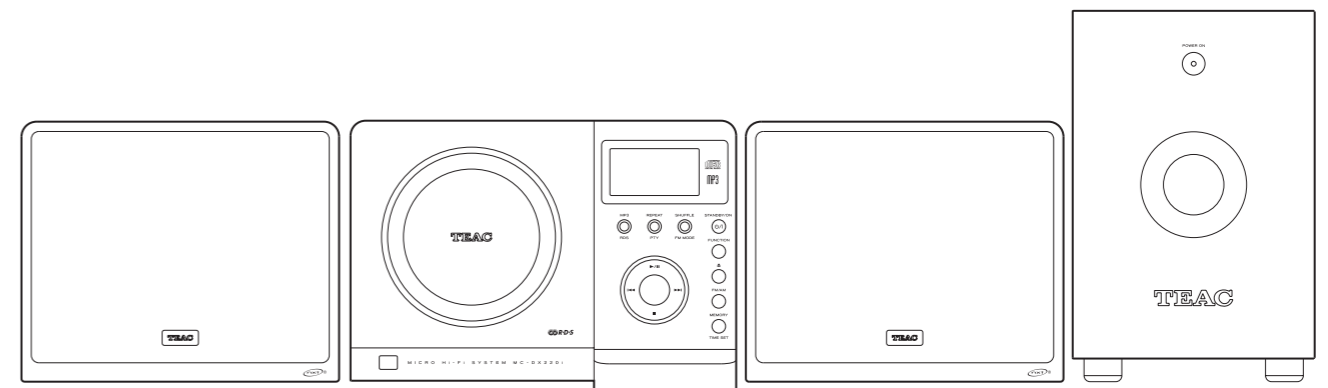



CAUTION

RISK OF ELECTRIC SHOCK
DO NOT OPEN



CAUTION: TO REDUCE THE RISK OF ELECTRIC SHOCK, DO NOT REMOVE COVER (OR BACK). NO USER-SERVICEABLE PARTS INSIDE. REFER SERVICING TO QUALIFIED SERVICE PERSONNEL.



The lightning flash with arrowhead symbol, within an equilateral triangle, is intended to alert the user to the presence of uninsulated "dangerous voltage" within the product's enclosure that may be of sufficient magnitude to constitute a risk of electric shock to persons.



The exclamation point within an equilateral triangle is intended to alert the user to the presence of important operating and maintenance (servicing) instructions in the literature accompanying the appliance.

IMPORTANT SAFETY INSTRUCTIONS

- 1) Read these instructions.
- 2) Keep these instructions.
- 3) Heed all warnings.
- 4) Follow all instructions.
- 5) Do not use this apparatus near water.
- 6) Clean only with dry cloth.
- 7) Do not block any ventilation openings. Install in accordance with the manufacturer's instructions.
- 8) Do not install near any heat sources such as radiators, heat registers, stoves, or other apparatus (including amplifiers) that produce heat.
- 9) Do not defeat the safety purpose of the polarized or grounding-type plug. A polarized plug has two blades with one wider than the other. A grounding type plug has two blades and a third grounding prong. The wide blade or the third prong are provided for your safety. If the provided plug does not fit into your outlet, consult an electrician for replacement of the obsolete outlet.
- 10) Protect the power cord from being walked on or pinched particularly at plugs, convenience receptacles, and the point where they exit from the apparatus.
- 11) Only use attachments/accessories specified by the manufacturer.
- 12) Use only with the cart, stand, tripod, bracket, or table specified by the manufacturer, or sold with the apparatus. When a cart is used, use caution when moving the cart/apparatus combination to avoid injury from tip-over. 
- 13) Unplug this apparatus during lightning storms or when unused for long periods of time.
- 14) Refer all servicing to qualified service personnel. Servicing is required when the apparatus has been damaged in any way, such as power-supply cord or plug is damaged, liquid has been spilled or objects have fallen into the apparatus, the apparatus has been exposed to rain or moisture, does not operate normally, or has been dropped.

Specifications

AMPLIFIER section

Output Power (L+R)	5 W + 5 W
Output Power (Subwoofer)	15 W
Input Sensitivity	300 mV
Frequency Response	50 to 20,000 Hz

TUNER Section (FM)

Frequency Range	87.50 to 108.00 MHz
Sensitivity (S/N30dB)	20 dBµV/m

TUNER Section (AM)

Frequency Range	522 to 1,620 kHz
Sensitivity (S/N20dB)	54 dBµV/m

CD PLAYER Section

Frequency Response	20 to 20,000 Hz (±1 dB)
Signal-to-Noise Ratio	55 dB
Wow and Flutter	Unmeasurable

SPEAKER

Type	Full range flat type
Impedance	4 ohms

SUBWOOFER

Impedance	8 ohms
---------------------	--------

GENERAL

Power Requirements	230 V AC, 50 Hz
Power Consumption	80 W

Dimension (W x H x D)

Main Unit	255 x 169.5 x 115 mm
L & R Speakers	210 x 169.5 x 81 mm
Subwoofer	160 x 245 x 335 mm

Weight (Net)

Main Unit	1.4 kg
L & R Speakers	0.7 kg each
Subwoofer	5.3 kg

Standard Accessories

- Remote Control Unit (RC-1103) x 1
- Battery for Remote Control Unit x 1
- Subwoofer Cable x 1
- Speaker Cable x 2
- FM Antenna x 1
- AM Antenna x 1
- Stereo mini plug cable x 1

- Dock adapter x 8
(adapter "60GB (color) + Photo 40GB/60GB" premounted)
- Cover for the Dock x 1

- Wall Mount Brackets x 2
- Screw (short) x 8
- Screw (long) x 4
- Tapered Plastic Wall Anchor x 4
- Guide sheet for wall mounting x 2

- Owner's Manual x 1
- Warranty Card x 1

- Design and specifications are subject to change without notice.
- Weight and dimensions are approximate.
- Illustrations may differ slightly from production models.

Troubleshooting

If you have problems with your system, look through this chart and see if you can solve the problem yourself before calling your dealer or TEAC service center.

General

No power

- ➔ Check the connection to the AC power supply. Check and make sure the AC source is not a switched outlet and that, if it is, the switch is turned on. Make sure there is power to the AC outlet by plugging another item such as a lamp or fan into the outlet.

No sound from speakers.

- ➔ Select the source by pressing the FUNCTION button.
- ➔ Check the connection to the speakers.
- ➔ Adjust the volume.
- ➔ Pull out the headphone's plug from the PHONES jack.
- ➔ If "MUTING" is blinking, press the MUTING button.

The sound is noisy.

- ➔ The unit is too close to a TV or similar appliances. Install the unit apart from them, or turn them off.

Remote control doesn't work.

- ➔ Press the STANDBY/ON switch to turn the unit on.
- ➔ When the battery has run out, put in a new one.
- ➔ Use remote control unit within the range (5 m) and point at the front panel.
- ➔ Clear obstacles between the remote control unit and the main unit.
- ➔ If a strong light is near the unit, turn it off.

CD Player

Will not play.

- ➔ Load a disc with the playback side facing away.
- ➔ If the disc is dirty, clean the surface of the disc.
- ➔ A blank disc has been loaded. Load a prerecorded disc.
- ➔ Depending on the disc, etc. it may not be possible to play back CD-R/RW discs. Try again with another disc.
- ➔ You cannot play back unfinalized CD-R/RW discs. Finalize such a disc in a CD recorder and try again.

Sound skips.

- ➔ Place the unit on a stable place to avoid vibration and shock.
- ➔ If the disc is dirty, clean the surface of the disc.
- ➔ Don't use scratched, damaged or warped discs.

iPod Player

Cannot insert the iPod.

- ➔ Check the dock adapter.
- ➔ Remove dust or obstacles from the Dock connector of the MC-DX220i and the iPod, and insert the iPod again.

Will not play.

- ➔ Remove the iPod from the dock, wait a few seconds, and insert it again.
- ➔ Software update may solve the problem. Visit the Apple website and download the latest iPod Software.

Tuner

Cannot listen to any station, or signal is too weak.

- ➔ Tune in the station properly.
- ➔ Rotate the FM or AM antenna for the best reception position.

Though the broadcast is stereo, it sounds monaural.

- ➔ Press the FM MODE button.

If normal operation cannot be recovered, unplug the power cord from the outlet and plug it again.

If the power switch of the subwoofer turned off, the settings kept in memory (clock, preset stations, timer setting) will be erased.

Beware of condensation

When the unit (or a disc) is moved from a cold to a warm place, or used after a sudden temperature change, there is a danger of condensation; vapor in the air could condense on the internal mechanism, making correct operation erratic or impossible. To prevent this, or if this occurs, leave the unit for one or two hours with the power turned on. The unit will stabilize at the temperature of its surroundings.

Maintenance

If the surface of the unit gets dirty, wipe with a soft cloth or use diluted mild liquid soap. Never spray liquid directly on this unit. Apply your cleaner to your cleaning cloth and wipe gently. Be sure to remove any excess completely. Do not use thinner, benzene or alcohol as they may damage the surface of the unit. Allow the surface of the unit to dry completely before using.

- Do not expose this apparatus to drips or splashes.
- Do not place any objects filled with liquids, such as vases, on the apparatus.
- Do not install this apparatus in a confined space such as a book case or similar unit.
- The apparatus draws nominal non-operating power from the AC outlet with its POWER switch in the off position.
- The apparatus should be located close enough to the AC outlet so that you can easily grasp the power cord plug at any time.
- An apparatus with Class I construction shall be connected to an AC outlet with a protective grounding connection.
- Batteries (battery pack or batteries installed) shall not be exposed to excessive heat such as sunshine, fire or the like.

WARNING: TO PREVENT FIRE OR SHOCK HAZARD, DO NOT EXPOSE THIS APPLIANCE TO RAIN OR MOISTURE.

CAUTION

- DO NOT REMOVE THE EXTERNAL CASES OR CABINETS TO EXPOSE THE ELECTRONICS. NO USER SERVICEABLE PARTS ARE WITHIN!
- IF YOU ARE EXPERIENCING PROBLEMS WITH THIS PRODUCT, CONTACT TEAC FOR A SERVICE REFERRAL. DO NOT USE THE PRODUCT UNTIL IT HAS BEEN REPAIRED.
- USE OF CONTROLS OR ADJUSTMENTS OR PERFORMANCE OF PROCEDURES OTHER THAN THOSE SPECIFIED HEREIN MAY RESULT IN HAZARDOUS RADIATION EXPOSURE.

Disposal of your old appliance

1. When this crossed-out wheeled bin symbol is attached to a product it means the product is covered by the European Directive 2002/96/EC.
2. All electrical and electronic products should be disposed of separately from the municipal waste stream via designated collection facilities appointed by the government or the local authorities.
3. The correct disposal of your old appliance will help prevent potential negative consequences for the environment and human health.
4. For more detailed information about disposal of your old appliance, please contact your city office, waste disposal service or the shop where you purchased the product.



Contents

Thank you for choosing TEAC. Read this manual carefully to get the best performance from this unit.

Important Safety Instructions	2
Before Using the Unit	4
Remote Control Unit	4
Discs	5
Connection	6
Wall Mounting	8
Getting started	9
Unit Functions	10

Basic Operation	12
-----------------	----

iPod

Listening to iPod	14
-------------------	----

CD/MP3

Listening to CD/MP3	16
Search Mode (MP3 only)	18
Shuffle Playback	19
Programmed Playback	20
Repeat Playback	22

TUNER

Listening to the Radio	23
Preset Tuning	24
RDS	25
RDS (PTY Search)	25

AUX

Listening to an External Source	26
---------------------------------	----

Setting the Clock	27
Setting the Timer	28

Troubleshooting	30
Specifications	31

Before Using the Unit

Read this before operation

- As the unit may become warm during operation, always leave sufficient space around the unit for ventilation. The ventilation holes should not be covered. Make sure there is at least 5 cm of space on each side of the unit. Do NOT place anything on top of the unit.
- The voltage supplied to the unit should match the voltage as printed on the rear panel. If you are in any doubt regarding this matter, consult an electrician.
- Choose the installation location of your unit carefully. Avoid placing it in direct sunlight or close to a source of heat. Avoid locations subject to vibrations and excessive dust, heat, cold or moisture.
- Do not place the unit on any other electronic components.
- Do not open the cabinet as this might result in damage to the circuitry or electrical shock. If a foreign object should fall into the unit, contact your dealer or service company as soon as possible.
- When removing the power plug from a wall outlet, always pull directly on the plug. Do not pull on the line cord.
- To keep the laser pickup clean, do not touch it and always close the CD door after each use.
- Do not attempt to clean the unit with chemical solvents as this might damage the finish. Use a clean, dry, lint-free cloth.
- Keep this manual in a safe place for future reference.

CAUTION: DO NOT MOVE THE UNIT DURING PLAYBACK

During playback, the disc rotates at high speeds. Do NOT lift or move the unit during playback. Doing so may damage the disc or the unit.

WHEN MOVING THIS UNIT

When changing places of installation or packing the unit for moving, be sure to remove the disc. Moving this unit with the disc loaded may result in malfunction or other damage.



NXT is a trademark of New Transducers Ltd.

Remote Control Unit

The provided Remote Control Unit allows the unit to be operated from a distance.

When operating the remote control unit, point it towards the remote sensor on the front panel of the unit.

- Even if the remote control unit is operated within the effective range, remote control operation may be impossible if there are any obstacles between the unit and the remote control.
- If the remote control unit is operated near other products which generate infrared rays, or if other remote control devices using infrared rays are used near the unit, it may operate incorrectly. Conversely, the other products may also operate incorrectly.

Battery Installation

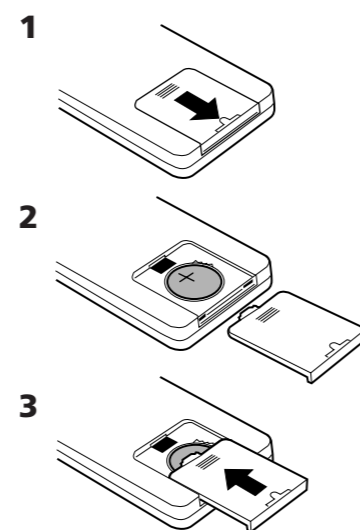

- 1 Remove the battery compartment cover.
- 2 Put in the lithium battery (CR2032, 3V).
- 3 Close the cover.

Battery Replacement

If the distance required between the remote control unit and main unit decreases, the battery is exhausted. In this case, replace the battery with a new one.

Precautions concerning batteries

Do not heat or disassemble batteries and never dispose of old batteries by throwing them in a fire.

- 6 Press the SKIP button (◀◀ / ▶▶) to select a source (TUNER, CD or iPod), and then press the TIMER button.

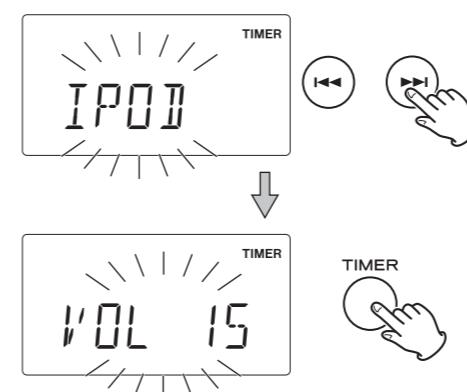

- 7 Press the SKIP button (◀◀ / ▶▶) to set the volume, and then press the TIMER button.

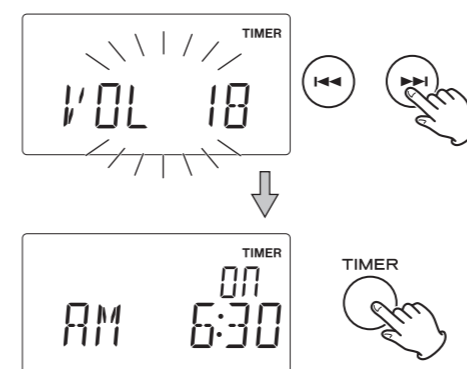

Setting the timer is now completed and the timer is turned on. Your timer setting is displayed one by one, and the TIMER indicator lights on the display.

- 8 Prepare the source.

If you selected "TUNER" in step 6, tune in a station.
If you selected "CD" in step 6, set a disc.
If you selected "iPod" in step 6, insert an iPod.

- 9 Press the STANDBY/ON button to turn the unit off (standby).

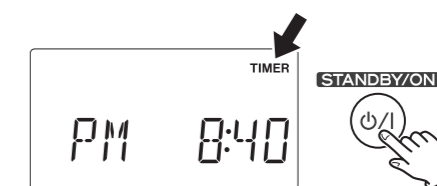

The clock and the TIMER indicator are displayed. The unit will turn on and off at the specified time every day.

Don't forget to turn the unit off (standby), or the timer won't work.

If the power switch of the subwoofer turned off, the settings kept in memory (clock, preset stations, timer setting) will be erased.

- Playback volume will gradually increase up to your set volume when the unit is turned on by timer.
- If the source is set to "iPod" but no iPod is set, the unit will turn on into TUNER mode.
- If the source is set to "CD" but no disc is set, the unit will turn on into TUNER mode.
- When the source is set to "TUNER" and the unit turns on, it will tune in to the station you selected last time.

To turn on or off the timer

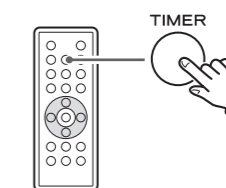

When you don't use the timer, press the TIMER button to turn it off. (The TIMER indicator disappears from the display.) Press the TIMER button again to turn it on.

- When the timer is turned on, the timer settings are displayed one by one, and the TIMER indicator lights on the display.

Setting the Timer

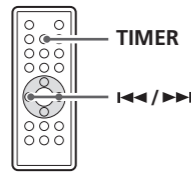

- The unit can be programmed to turn on and off at a specified time.
- Adjust the clock before setting the timer.

1 Press and hold the **TIMER** button until the **TIMER** indicator and **"ON"** appear on the display.



The "hour" value starts flashing.

- When no button is pressed for 10 seconds, the timer setting mode will be cancelled.

2 Press the **SKIP** button (◀▶) to set the start time (hour), and then press the **TIMER** button.

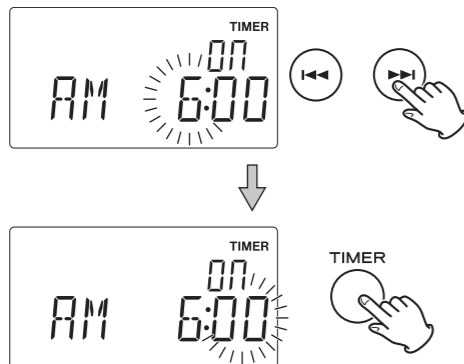

The "minutes" value starts flashing.

3 Press the **SKIP** button (◀▶) to set the start time (minute), and then press the **TIMER** button.

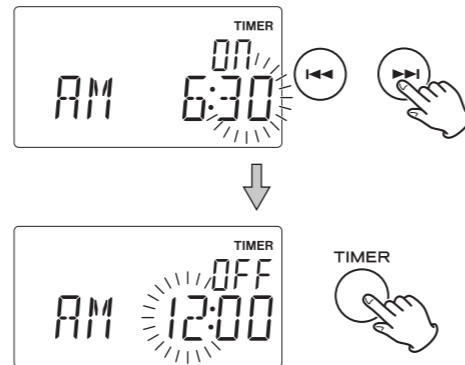

"TIMER" and "OFF" indicators appear on the display and the "hour" value starts flashing.

4 Press the **SKIP** button (◀▶) to set the stop time (hour), and then press the **TIMER** button.

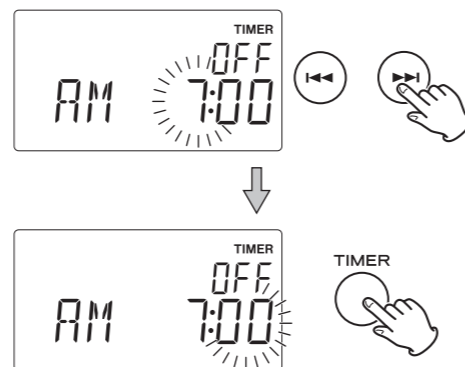

The "minutes" value starts flashing.

5 Press the **SKIP** button (◀▶) to set the stop time (minute), and then press the **TIMER** button.

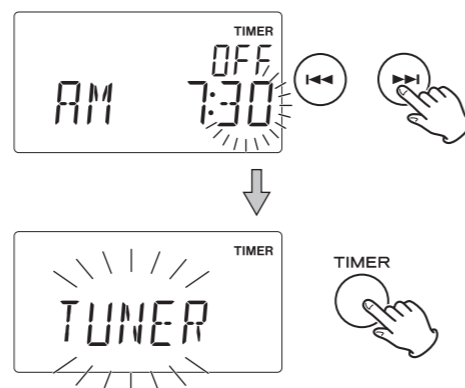

Discs

Discs which can be played on this unit:

- Conventional audio CDs bearing the COMPACT DISC DIGITAL AUDIO logo on the label:



- Properly finalized CD-R and CD-RW discs
- MP3 CDs

Note:

- Depending on the quality of the disc and/or the condition of the recording, some CD-R/CD-RW discs may not be playable.
- Copy-protected discs and other discs that do not conform to the CD standard may not play back correctly in this player. If you use such discs in this unit, TEAC Corporation and its subsidiaries cannot be responsible for any consequences or guarantee the quality of reproduction. If you experience problems with such non-standard discs, you should contact the producers of the disc.

- Always place the disc on the disc tray with the label side up. (Compact discs can be played or recorded only on one side.)

- To remove a disc from its storage case, press down on the center of the case and lift the disc out, holding it carefully by the edges.



How to remove the disc

How to hold the disc

- Should the disc become dirty, wipe the surface from the center hole outward towards the outer edge with a soft, dry, lint-free cloth:



- Never use chemicals such as record (LP) sprays, antistatic sprays or fluids, benzine or thinner to clean the discs. Such chemicals will do irreparable damage to the disc's plastic surface.

- Discs should be returned to their cases after each use to avoid dust and scratches that may eventually cause your disc to skip.

- Do not expose discs to direct sunlight, high humidity, or high temperatures for extended periods. Long exposure to high temperatures will warp the disc.

- Do not play any disc that is warped, scratched, deformed or damaged. Playing such discs may cause irreparable harm to the playback mechanism.

- CD-R and CD-RW discs are more sensitive to the effects of heat and ultraviolet rays than ordinary CDs. It is important that they are not stored in a location with direct sunlight and keep your discs away from sources of heat such as radiators or heat-generating electrical devices.

- Printable discs aren't recommended because the label side might be sticky (or contain glue), which will damage the unit.

- Do not stick papers or protective sheets on the discs and do not use any protective coating spray.

- Use a soft oil-based felt-tipped pen to write information on the label side of a disc. Never use a ball-point or hard-tipped pen, as this may cause damage to the recorded side of the disc.

- Never use a stabilizer. Using commercially available CD stabilizers with this unit will damage the mechanisms and cause them to malfunction.

- Do not use irregular shape CDs (octagonal, heart shaped, business card size, etc.). CDs of this sort can damage the unit:

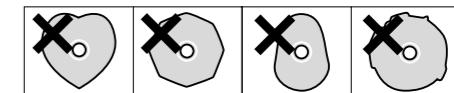

- If you are in any doubt as to the care and handling of any disc, read the precautions supplied with the disc, or contact the disc manufacturer directly.

MP3 compatibility

- File names of MP3 should be alphanumeric characters. This unit cannot display symbols and full-size or 2 bytes-wide characters (such as Japanese, Chinese, etc.) correctly. Also, be sure to use the file extension ".mp3".

- The disc must be finalized in order to play.

- The CD-ROM must be ISO 9660 compatible.

- When more than 200 files or folders are recorded on the disc, the unit might not be able to play it correctly.

- The file must be mono or stereo MPEG-1 Audio Layer 3 format, 44.1 or 48 kHz, fixed bit-rate.

Connection

CAUTION

- Turn off the power of all the equipment before making connections.
- Read instructions of each component you intend to use with this unit.
- Be sure to insert each plug securely. To prevent hum and noise, do not bundle the connection cords with the power cord.

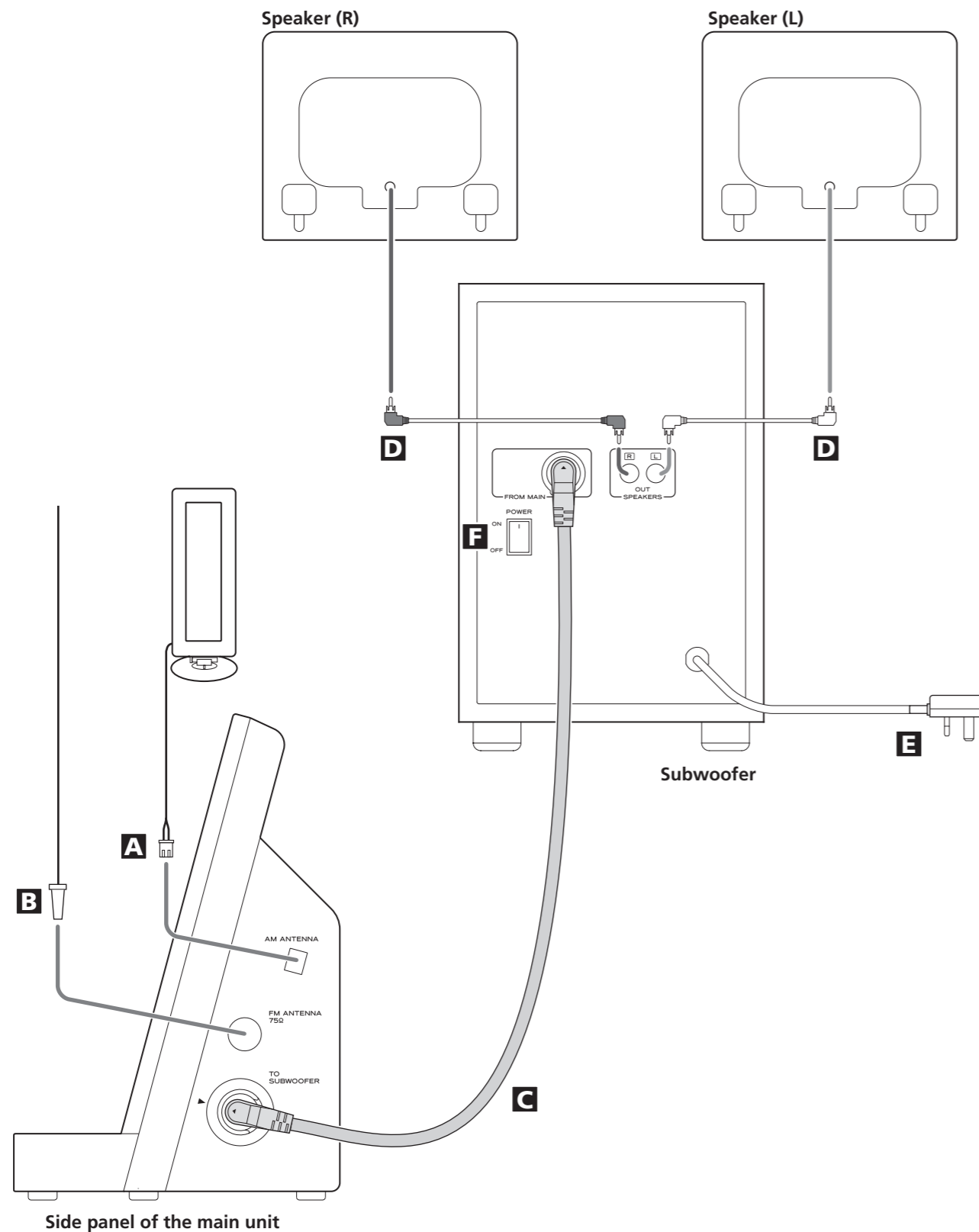

Setting the Clock

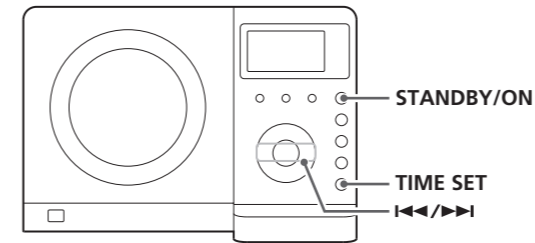

If the power switch of the subwoofer turned off, the settings kept in memory (clock, preset stations, timer setting) will be erased.

- 1 If the unit is on, press the STANDBY/ON switch to turn it standby



- 2 Press and hold down the TIME SET button.

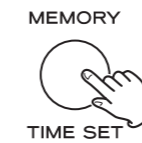

"12 HOUR" or "24 HOUR" blinks. If you want to change the hour mode, press the SKIP or SKIP button.

- If no button is pressed for 10 seconds, the time setting mode will be cancelled.

- 3 Press the TIME SET button once more.

The "hour" value blinks.

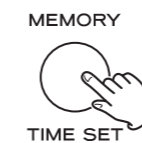

- 4 Press the SKIP button (SKIP / SKIP) to set the current hour.

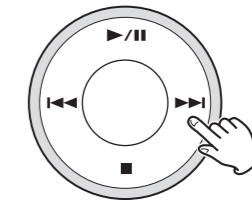

- 5 Press the TIME SET button.

The "minute" value blinks.

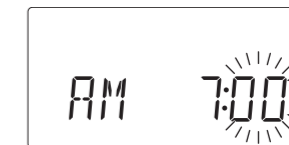
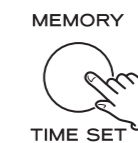

- 6 Press the SKIP button (SKIP / SKIP) to set the current minute.

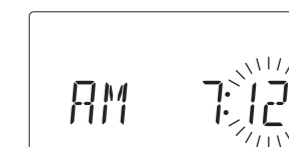
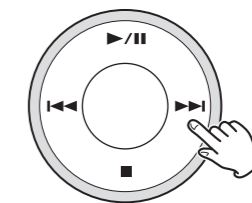

- 7 Press the TIME SET button.

The clock starts.

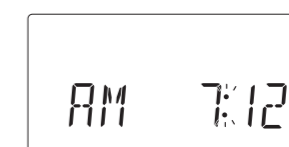
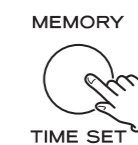

RDS (PTY Search 2)

PTY (Programme Type)

- NEWS : brief announcements, events, public opinion, reports, actual situations.
- AFFAIRS : a kind of suggestion including practical announcements other than news, documents, discussion, analysis and so on.
- INFO : daily information or reference such as weather forecast, consumer guide, medical assistance and so on.
- SPORT : sports related programs.
- EDUCATE : educational and cultural information.
- DRAMA : all kinds of radio concert and serial drama.
- CULTURE : all aspects of national or local culture including religious events, philosophy, social science, language, theatre, and so on.
- SCIENCE : programs on natural science and technology
- VARIED : popular programs such as quiz, entertainment, private interview, comedy, satire and so on.
- POP M : program on commercial, practical and popular songs, and sale volume of discs, etc.
- ROCK M : practical modern music generally composed and played by young musicians.
- M O R M : popular music usually lasting for less than 5 minutes.
- LIGHT M : classical music, instrumental music, chorus, and light music favored by non-professionals.
- CLASSICS : orchestra including great operas, symphony, chamber music and so on.
- OTHER M : other music styles(Rhythm & Blues, Reggae, etc.)
- WEATHER : weather reports, forecast
- FINANCE : financial reports, commerce, trading
- CHILDREN : children's programs
- SOCIAL A : social affairs
- RELIGION : religious programs
- PHONE IN : program in which the public expresses its view by phone.
- TRAVEL : travel reports
- LEISURE : programs concerning recreational activities
- JAZZ : jazz music
- COUNTRY : country music
- NATIONAL : national music
- OLDIES : music from the so-called golden of popular music
- FOLK M : folk music
- DOCUMENT: documentaries
- TEST
- ALARM : a program notifying an emergency or a natural disaster.

Listening to an External Source

- 1** Connect the PHONES jack (audio output jack) of a portable audio player to the AUX IN jack of the MC-DX220i using the supplied stereo mini plug cable.

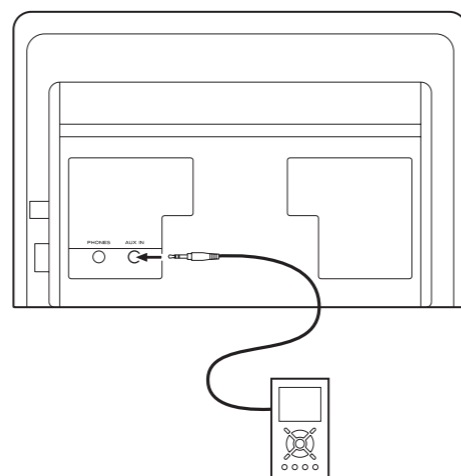

- 2** Press the FUNCTION button to select "AUX".

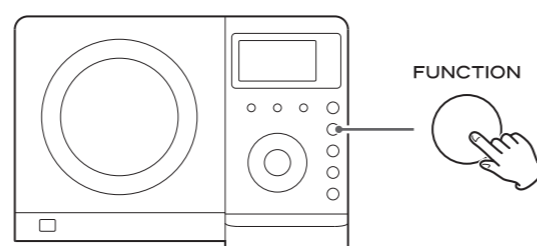

- 3** Play the source, and adjust the volume using the VOLUME buttons of the MC-DX220i and the audio player.

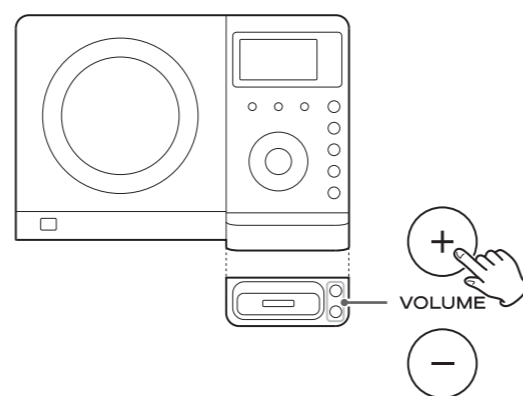

When using the PHONES jack of your mini player, you must adjust the volume of the mini-player or you may hear no sound from your MC-DX220i.

A AM loop antenna

Position the antenna for the best sound. If you want, you can hook the AM antenna on a wall as shown below:

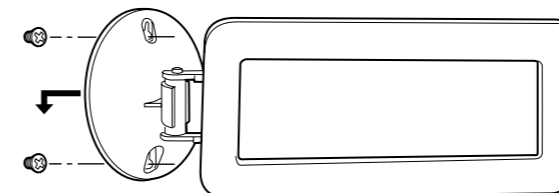

B FM antenna

While in FM mode, tune in an FM station and extend the lead to find the best position for reception. This antenna may need to be repositioned if you move your unit to a new location.

FM Outdoor Antenna

In an area where FM signals are weak, it will be necessary to use a 75-ohm unbalanced-type outdoor FM antenna using an optional (not supplied) matching transformer connected to an external antenna. Generally, a 3-element antenna will be sufficient; if you live in an area where the FM signals are particularly weak, it may be necessary to use one with 5 or more elements.

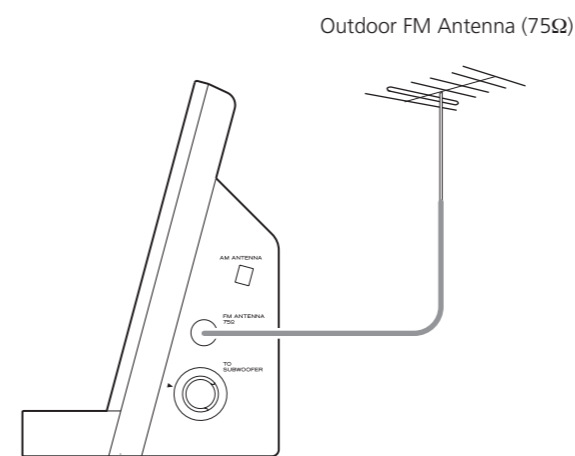

C Subwoofer

Connect the "TO SUBWOOFER" and the "FROM MAIN" sockets using the supplied cable.

- Connect the Connectors in the direction as figured.

D SPEAKERS

Connect the left speaker's plug to L, and the right speaker's plug to R.

- If not using the included speakers, make sure the speakers you use are at least 4 Ω impedance.
- Do not connect anything other than speakers to these terminals.

E AC Power Cord

Be sure to connect the power cord to an AC outlet which supplies the correct voltage.

Hold the power plug when plugging or unplugging the power cord. Never pull or yank on the power cord.

F POWER switch of the Subwoofer

Use this switch to turn the system on or off.

The equipment draws a nominal amount of power from the AC outlet even with its POWER switch in the OFF position.

- If the power switch of the subwoofer turned off, the settings kept in memory (clock, preset stations, timer setting) will be erased. To avoid losing your settings, it is advisable to keep this switch ON when not in use.

G AUX IN

You can connect a portable audio player to this jack. Connect the LINE OUT or PHONES jack (audio output jack) of the player using the supplied stereo mini plug cable.

When using the PHONES jack of your mini player, you must adjust the volume of the mini-player or you may hear no sound from your MC-DX220i.

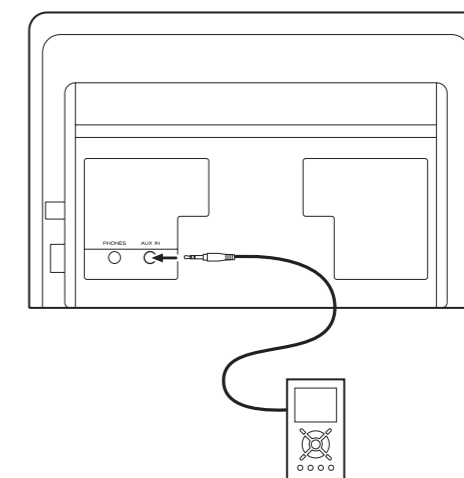

Wall Mounting

You can mount the left and right speakers on a wall.

Precautions

- Be aware that the length of the cables are approximately 3 m. Do not attempt to mount the speakers too far from the subwoofer.
- Drill holes into solid wall support, such as wooden frame or concrete wall.
- TEAC supplies these brackets as a convenience to the product owner. Consult your local building codes and exercise all necessary caution when mounting these brackets. If you are unsure how to use the supplied brackets, consult with a local tradesmen or building supply expert.

To hook on the wall

1. Fix the brackets on the rear panel of the speakers using the supplied short screws.

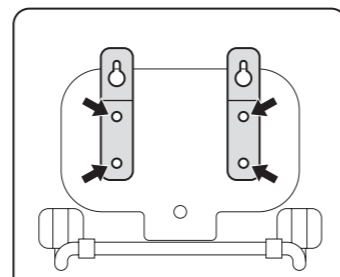

2. Use the supplied guide sheet to mark the exact drilling points on the wall.

3. Drill holes in the wall at the marked points.

4. Screw the supplied long screws into the wall.

Leave about 5 mm space between the screw's head and the wall.

- As a convenience, a set of tapered plastic anchors is supplied. If you chose to use these anchors, drill a pilot hole using a 6 mm drill bit then tap the anchor into the pilot hole. Only use these anchors if they are appropriate for the materials onto which the unit is to be mounted. Consult your local hardware store if you are uncertain.

5. Before going on, connect the speakers and the subwoofer using the supplied speaker cables (see page 6-7).

6. Carefully hang the speakers onto the screws.

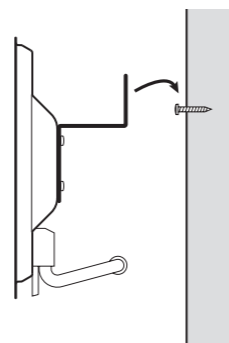

Note:

Ensure that the speaker locks onto the hooks and that the hooks are strong enough to support the weight before removing your hands.

RDS

The Radio Data System (RDS) is a broadcasting service which allows stations to send additional information along with the regular radio programme signal.

RDS works on the FM waveband in Europe only.

1. Tune in an FM RDS station (see steps 1 to E of page 23).

The Programme Service name (station's name) appears on the display.

2. Press the RDS button.

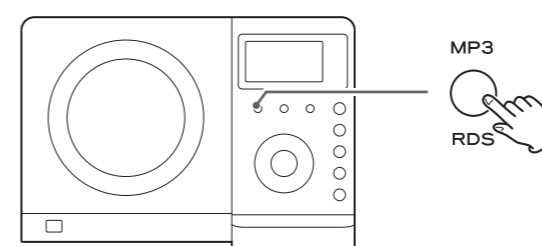

Each time the RDS button is pressed, the RDS mode is changed as follows:

PS (Programme Service name)

When you select PS, the frequency will be displayed for 3 seconds, and then PS (station's name) will be displayed. If there is no PS data, "NO PS" will be displayed.

PTY (Programme Type)

When you select PTY, the programme type will be displayed. If there is no PTY data, "NO PTY" will be displayed.

RT (Radio Text)

When you select RT, the news of stations composed of up to 64 symbols will be displayed. If there is no RT data, "NO RT" will be displayed.

RDS (PTY Search 1)

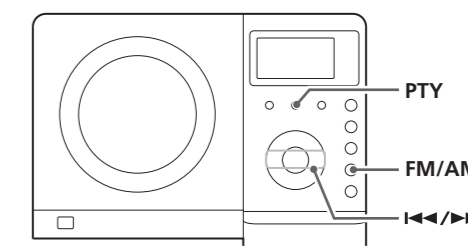

A station can be searched by this function.

1. Select FM by pressing the FM/AM button.

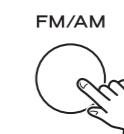

2. Press the PTY button.



"PTY SEL" blinks on the display.

3. Within 10 seconds, select the desired PTY programme using the SKIP button (◀◀ or ▶▶).

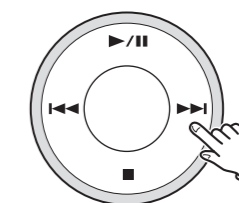

You can select from 31 kinds (see page 26).

4. Press the PTY button.



Searching will start.

- When the programme that you have selected is found, searching will stop and the programme type will be displayed.
- If the same program type is not found during PTY Search, it will stop at the beginning frequency.
- If you want to stop searching, press the PTY button.

Preset Tuning

You can store FM and AM stations into preset channels 1 to 10 respectively.

If the power switch of the subwoofer turned off, the settings kept in memory (clock, preset stations, timer setting) will be erased.

1 Tune in a station you want to listen to (see steps **1** to **3** of page 23).

2 Press the MEMORY button.

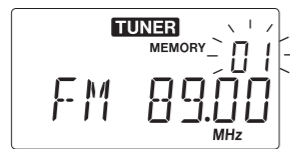
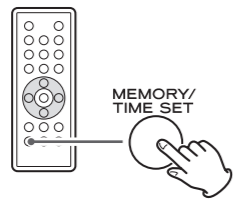

3 Within 5 seconds, select a preset channel to store the station using the PRESET buttons of the remote control unit.

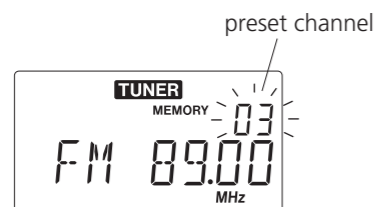
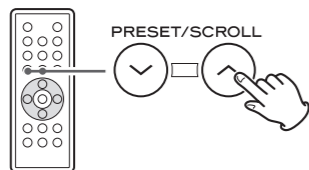

4 Within 5 seconds, press the MEMORY button.

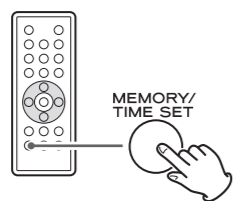

The station is stored and the MEMORY indicator goes off. To store more stations, repeat steps **1** to **4**.

How to select preset stations

1 Press the FM/AM button to select a band.

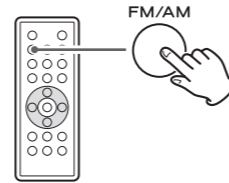

2 Press the PRESET button repeatedly until the desired preset station is found.

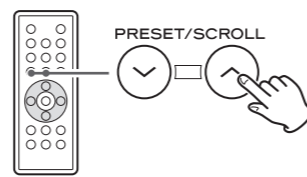

Getting started

The MC-DX220i comes mounted with an adapter for iPod with color display (40GB, 60GB), "60GB (color) + Photo 40GB/60GB". To play your iPod through the MC-DX220i, you have first to check if the factory mounted adapter fits your model of iPod. If it does not, you have to replace it with a correct one, as explained below.

1. Remove the adapter from the Dock of the MC-DX220i.

Hold the left and right sides of the adapter and gently pull it up.

2. Choose the Dock adapter that fits your iPod mobile digital device.

"Video 30GB" for iPod with video (30 GB).

"Video 60GB" for iPod with video (60 GB).

"nano" for iPod nano.

"mini" for iPod mini.

"20GB (color) + Photo 30GB" for iPod with color display (20GB, 30GB, U2 Special Edition).

"60GB (color) + Photo 40GB/60GB" for iPod with color display (40GB, 60GB).

"20GB + U2" for iPod with Click Wheel (20 GB, U2 Special Edition).

"40GB" for iPod with Click Wheel (40 GB).

• Use a commercially available adapter to play iPod with dock connector (with four buttons under the display).

3. Insert the adapter into the Dock of the MC-DX220i.

Fit the front edge of the adapter into the Dock, and then press the back edge of the adapter onto the Dock until a slight "click" is heard indicating the adapter is inserted correctly.

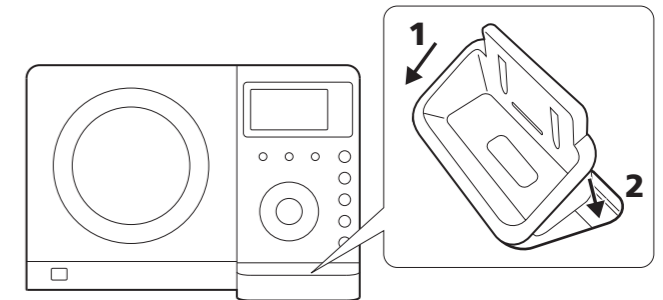

• When you need to remove the adapter, hold the left and right sides of the adapter and gently pull it up.

• When you don't use the Dock, use the supplied cover for the Dock to prevent dust from settling on the Dock.

Compatible iPod Software

In case your iPod will not work with the MC-DX220i or with the remote control unit, software update may solve the problem. Visit the Apple website and download the latest iPod Software.

<http://www.apple.com/ipod/download/>

iPod is a trademark of Apple Computer, Inc., registered in the U.S. and other countries.

Unit Functions

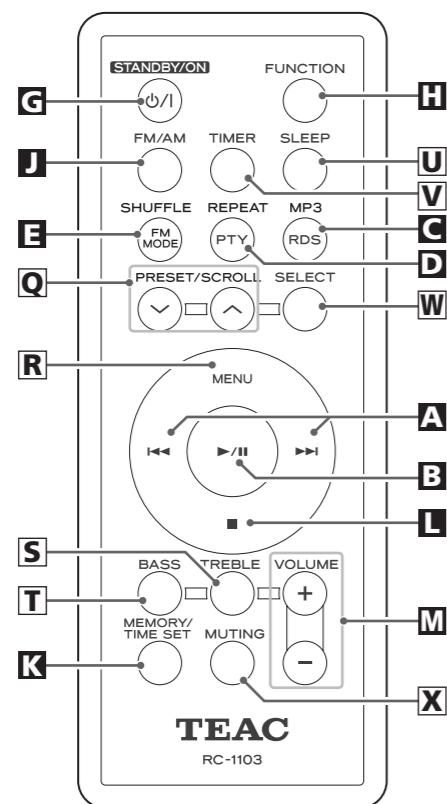
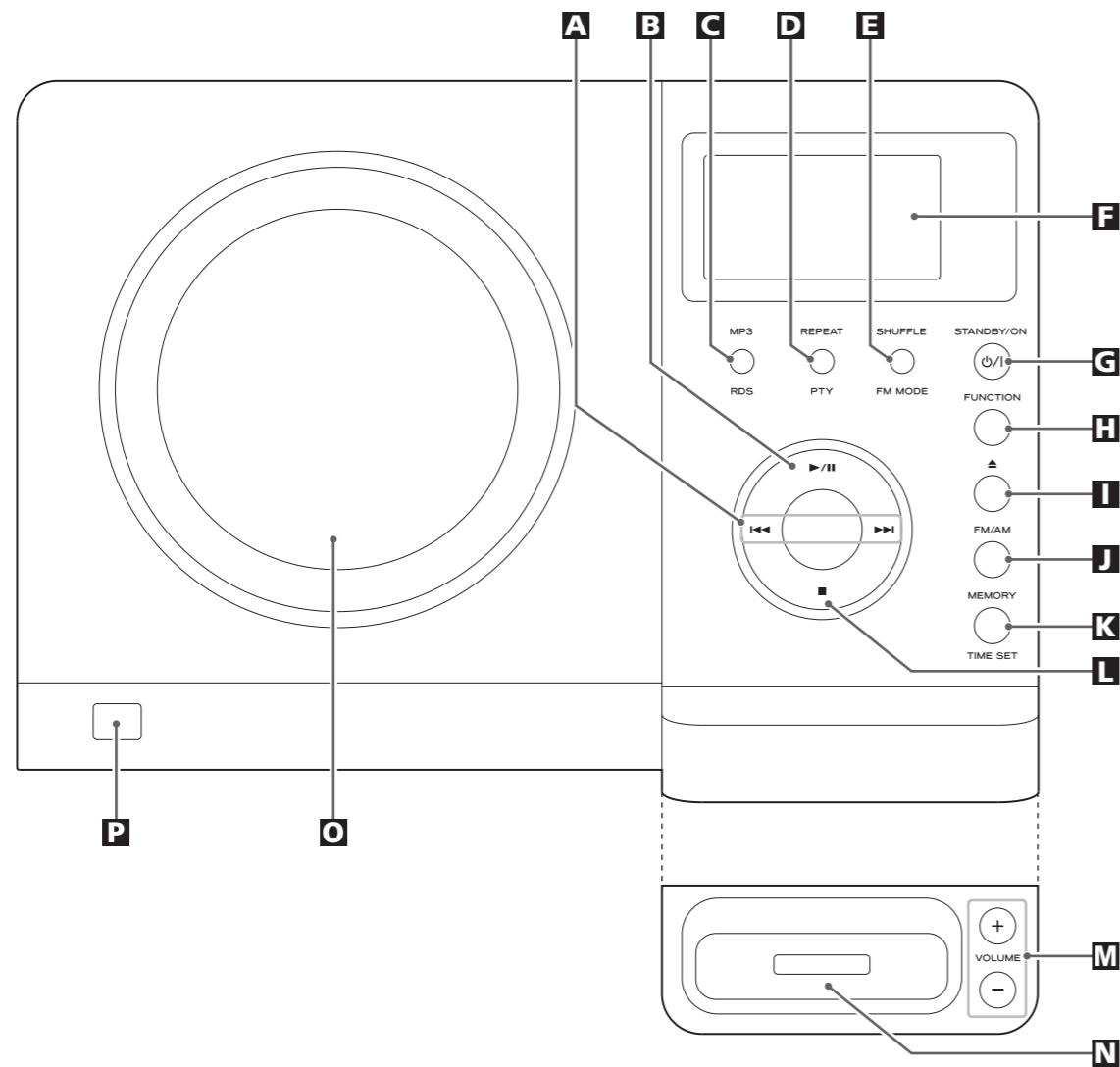

Note:

To simplify explanations, instructions in this manual refer to the names of the buttons and controls on the front panel only. Associated controls on the remote control will also operate similarly.

Listening to the Radio

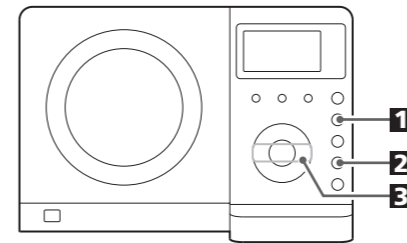

1 Press the **FUNCTION** button to select "TUNER".

- You can also use the FM/AM button to select "TUNER".

2 Press the **FM/AM** button to select a band.

3 Select the station you want to listen to (auto selection).

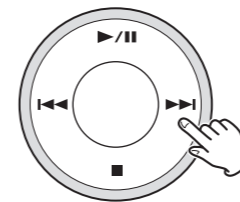

Hold down the TUNING Up or Down button until the frequency display begins to change. When a station is tuned in, the tuning process will stop automatically.

- Press the Up or Down button to stop the auto selection.

Selecting stations which cannot be tuned automatically (manual selection)

When the Up or Down button is pressed momentarily, the frequency changes by a fixed step. Press the Up or Down button repeatedly until the station you want to listen to is found.

FM MODE button

Pressing this button alternates between STEREO mode and MONO mode.

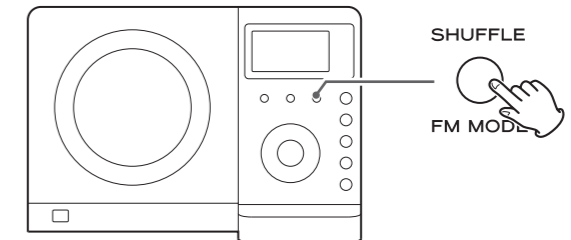

STEREO

FM stereo broadcasts are received in stereo and the "STEREO" indicator lights in the display.

- If the sound is distorted and the "STEREO" indicator flashes, the signal is not strong enough for good stereo reception. In this case, change to MONO mode.

MONO

To compensate for weak FM stereo reception, select this mode. Reception will now be forced to monaural, reducing unwanted noise.

If the reception is poor

AM broadcast

Rotate or relocate the AM antenna to find the best position for AM stations.

FM broadcast

Extend and rotate the FM antenna until you receive the stations clearly. You may need to relocate the unit.

Repeat Playback

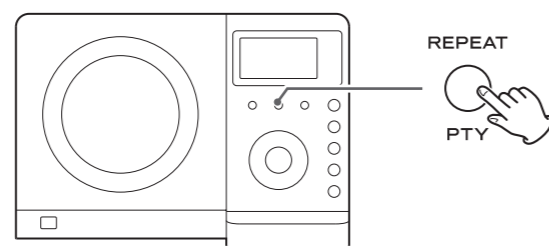

Every time the REPEAT button is pressed, the mode is changed as follows:

When a CD is loaded:

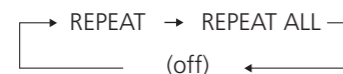

When a MP3 disc is loaded.

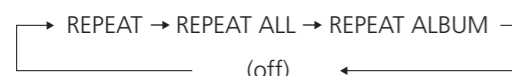

- If one of the following buttons is pressed, repeat mode will be canceled:

STOP, FUNCTION, FM/AM, OPEN/CLOSE, STANDBY/ON

Repeat one track

Press the REPEAT button once during playback. "REPEAT" lights.

The track being played will be played repeatedly. If you press the Skip button (◀◀ or ▶▶) and select another track, the track you selected will be played repeatedly.

It is also possible to select a track to be repeated in the stop mode. Press the REPEAT button, select a track using the Skip button (◀◀ or ▶▶), and then press the Play/Pause button (▶/||) to start playback.

Repeat all the tracks

All the tracks will be played repeatedly.

Press the REPEAT button twice. "REPEAT ALL" lights.

During programmed playback, programmed tracks will be played repeatedly.

Repeat all the tracks in the folder (MP3)

All the tracks in the folder will be played repeatedly.

Press the REPEAT button three times. "REPEAT ALBUM" lights.

A SKIP (◀◀/▶▶) / TUNING

In iPod or CD mode, momentarily press this button to skip tracks. Hold down this button to search for a part of a track.

In TUNER mode, momentarily press this button to tune in stations.

In Standby mode, these buttons are used to set or adjust the clock and the timer.

B PLAY/PAUSE (▶/||)

In iPod or CD mode, use this button to start or pause playback.

C MP3/RDS

During playback of a MP3 disc, use this button to search track name.

In FM TUNER mode, use this button to select an RDS mode.

D REPEAT/PTY

In iPod or CD mode, use this button to set the repeat function.

In FM TUNER mode, use this button to start PTY search.

E SHUFFLE/FM MODE

In iPod or CD mode, use this button to turn on and off the shuffle playback.

In FM TUNER mode, use this button to select STEREO or MONO.

F Display

G STANDBY/ON

Use this button to turn the unit on or standby.

The main unit is powered via the subwoofer. You need to first turn on the subwoofer.

When the main unit is in the standby mode, the power indicator of the Subwoofer is orange.

When the unit is turned on, the indicator turns blue.

The equipment draws a nominal amount of power from the AC outlet even with its STANDBY/ON switch in the STANDBY position.

H FUNCTION

Use this button to select a source (iPod, CD, TUNER or AUX).

I OPEN/CLOSE

In CD mode, use this button to open and close the CD door.

J FM/AM

Use this button to select AM or FM.

K MEMORY/TIME SET

In CD mode, use this button to program tracks.

In TUNER mode, use this button to preset stations.

This button is also used for clock adjustment.

L STOP (■)

In CD mode, use this button to stop playback.

- This button doesn't work in iPod mode.

M VOLUME

Press the up "+" or the down "-" button to adjust the volume.

N Dock connector

Before use, insert an appropriate Dock adapter in the Dock (see page 9).

Insert an iPod mobile digital device into this dock.

O CD door

P Remote Sensor

When operating the remote control unit, point it towards here.

Q PRESET/SCROLL

In TUNER mode, use these buttons to select a preset station.

In iPod mode, use these buttons to scroll up and down the menu.

During playback of a MP3 disc, use these buttons to select a folder in the disc.

R MENU

This button is equivalent to the MENU button on your iPod.

In iPod mode, use this button to go back to the previous menu.

S TREBLE

Use this button and the VOLUME buttons to adjust the level of high frequency sound range.

T BASS

Use this button and the VOLUME buttons to adjust the level of low frequency sound range.

U SLEEP

Use this button to set sleep timer.

V TIMER

Use this button together with the SKIP buttons to set the timer.

W SELECT

This button is equivalent to the Center button on your iPod.

In iPod mode, use this button to confirm selection in menus.

X MUTING

Use this button to mute the sound.

Basic Operation

(Rear panel of the subwoofer)

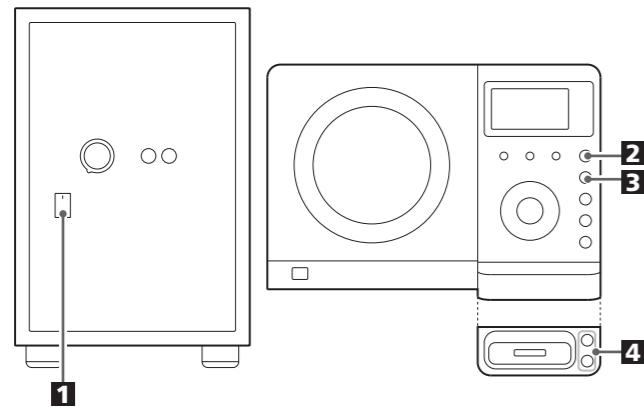

1 Turn on the subwoofer.

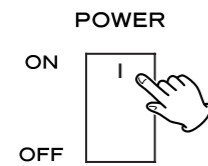

2 Press the STANDBY/ON switch on the main unit.



3 Select a source by pressing the FUNCTION button.



- To listen to an external source connected to the AUX IN jack, select AUX.
- In iPod and AUX modes, the display always shows the clock.
- If you press and hold the TIME SET button for 2 seconds in CD or TUNER mode, the clock will be displayed for a few seconds.

4 Play the source and adjust the volume using the VOLUME buttons.

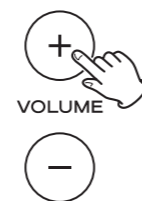

To check the programmed order

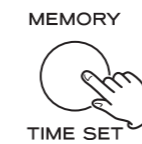

In the stop mode, press the MEMORY button repeatedly. The track number and program number will be shown on the display.

To add a track to the end of the program

In the stop mode, press the MEMORY button repeatedly until "00" appears on the display. Select a track number using the Skip button (◀◀ or ▶▶) and then press the MEMORY button. The track is added to the end of the program.

To overwrite the program

In the stop mode, press the MEMORY button repeatedly until the program number to be changed appears on the display. Select a new track number using the Skip button (◀◀ or ▶▶) and then press the MEMORY button.

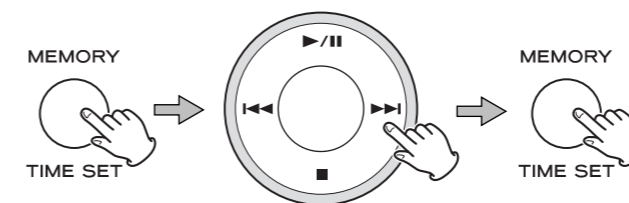

To clear program

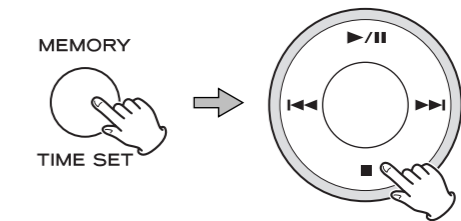

To clear the programmed contents, press the MEMORY and the STOP button (■) in the stop mode.

- If one of the following buttons is pressed, the programmed contents will also be cleared:
OPEN/CLOSE, FUNCTION, FM/AM, STANDBY/ON
- If the unit is disconnected from the power supply, the programmed contents will be cleared.

Programmed Playback

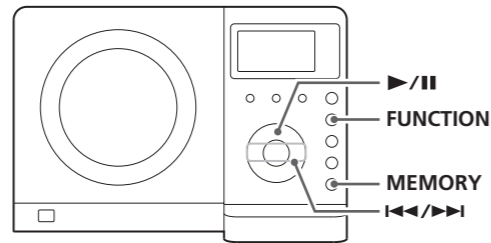

Up to 64 tracks can be programmed in the desired order.

1 Press the **FUNCTION** button to select "CD".

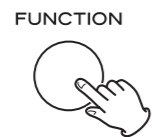

2 Press the **MEMORY** button.

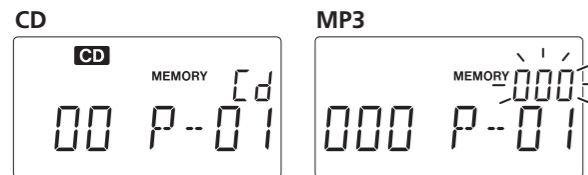
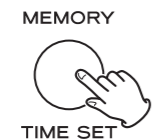

"MEMORY" lights up in the display.

- To cancel the program mode, press the Stop button (■).

3 Press the **Skip** button (◀◀ or ▶▶) repeatedly to select a folder of a MP3 disc, then press the **MEMORY** button.

- MP3 tracks recorded out of folders are in the "001" (ROOT) folder.
- Skip this step when playing a CD.

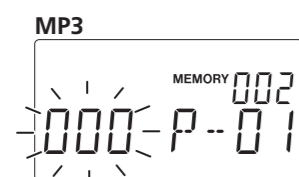
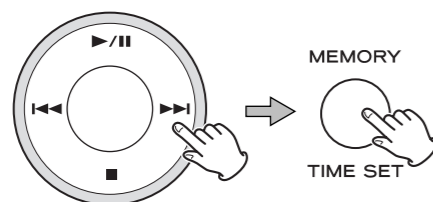

4 Press the **Skip** button (◀◀ or ▶▶) repeatedly to select a track, then press the **MEMORY** button.

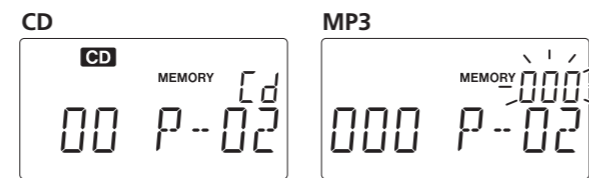
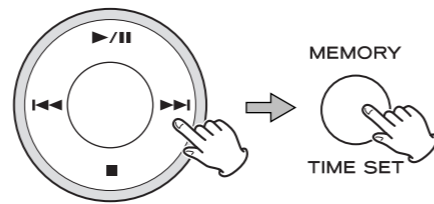

The track is programmed, and "P-02" is displayed.

- Repeat steps **3** and **4** to program more tracks.
- You can program up to 64 tracks.

5 When the selection of track numbers is completed, press the **Play/Pause** button (▶/||) to start program playback.

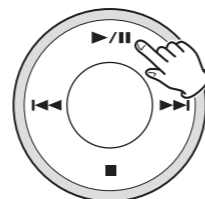

- When the playback of all the programmed tracks has finished, or if you press the Stop button (■), the MEMORY indicator will go off and the program mode will be cancelled. Still the program is retained in memory. You can return to the programmed playback by pressing the MEMORY button and the Play/Pause button (▶/||).
- Shuffle function doesn't work during programmed playback.

Muting

To mute the sound temporarily, press the **MUTING** button. Press the **MUTING** button again to restore the sound.

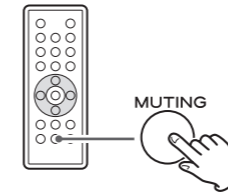

- While muting is engaged, "MUTING" blinks on the display.
- If you change the volume during the muting, the muting will be canceled.

Headphones

For private listening, first reduce the volume level to minimum. Then insert the plug from your headphones into the PHONES jack, and adjust the volume using the **VOLUME** buttons. The sound from the speakers is cut off while the headphone jack is inserted.

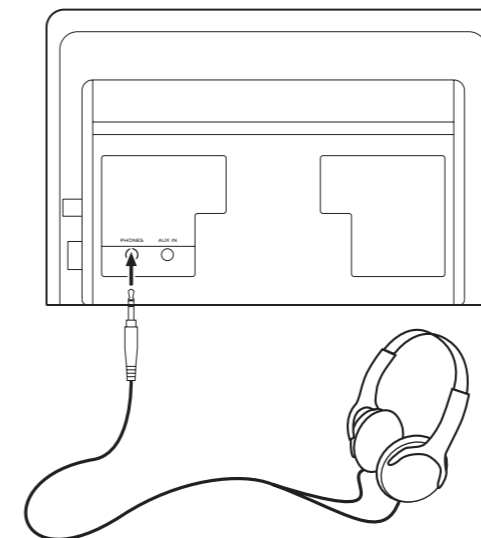

CAUTION

Always lower the volume level prior to plugging in your headphones. **TO AVOID DAMAGING YOUR HEARING** - Do not place your headphones on your head until after you have plugged them in.

Sleep Timer

Repeatedly pressing the **SLEEP** button permits setting an interval (from 90 down to 10 minutes) after which you want the unit to automatically turn off and shift into Standby mode.

Each press of the **SLEEP** button changes the time indication by 10 minutes.

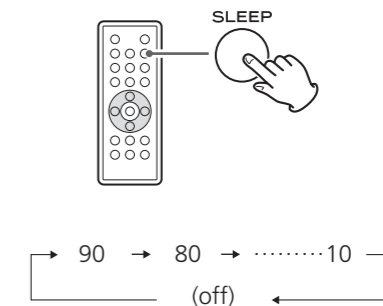

Tone Control

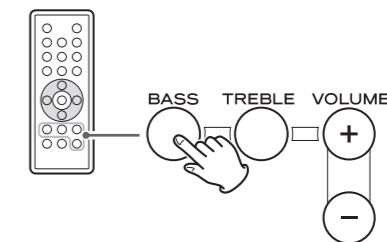

1. Press the BASS or TREBLE button.

To adjust the level of low frequency sound range, press the bass button.

To adjust the level of high frequency sound range, press the treble button.

2. Within 5 seconds, press the VOLUME buttons to change the setting.

The level can be adjusted from -4 to +4.

Listening to iPod

Insert the iPod into the Dock of the MC-DX220i.

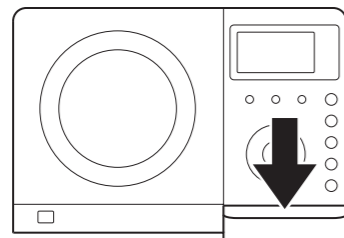

Then press the Play/Pause button (▶/||) on the iPod. The MC-DX220i will automatically turn on and start playback from the iPod's music list.

- If the iPod that is in playback mode is inserted into the Dock, the MC-DX220i will automatically turn on and start playback of the iPod.
- Make sure to use an appropriate Dock adapter (see "Getting started" on page 9).
- The battery of the iPod is recharged to the full whenever the iPod is docked and the MC-DX220i is connected to the AC power supply.
- When headphones are plugged into the iPod, sound comes from both the speakers of the MC-DX220i and the headphones.
- The Stop button (■) doesn't work in iPod mode.

To select iPod mode

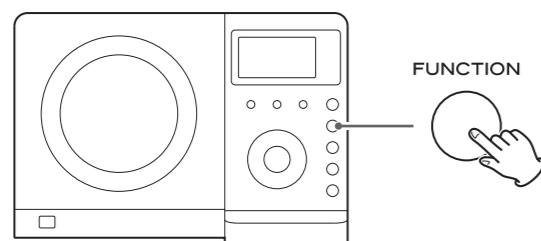

Select "iPod" using the FUNCTION button. If an iPod is already docked, playback will start.

When no iPod is docked, the iPod indicator on the display blinks.

In iPod mode, press the Play/Pause button (▶/||) to start or pause playback.

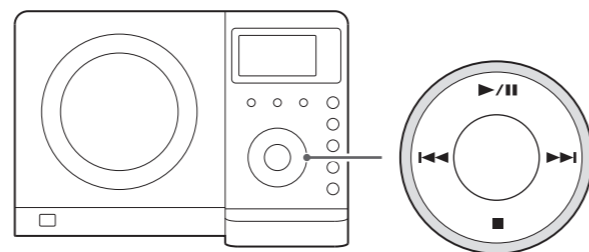

To suspend playback temporarily (pause mode)

Press the Play/Pause button (▶/||) during playback. Playback stops at the current position. To resume playback, press the Play/Pause button (▶/||) again.

To skip to the next or a previous track

During playback, press the skip button (◀◀ or ▶▶) repeatedly until the desired track is found. The selected track will be played from the beginning.

- When the ◀◀ button is pressed during playback, the track being played will be played from the beginning. To return to the beginning of the previous track, press the ◀◀ button twice.

Search for a part of a track

During playback, hold down the skip button (◀◀ or ▶▶) for more than 2 seconds and release it when the part you want to listen to is found.

Search for a track in a folder

1 Press the MP3 button twice.

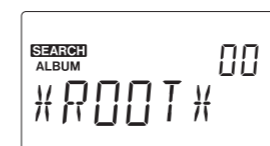

The name of folder is displayed.

- MP3 tracks recorded out of folders are in the "ROOT" folder.

2 Press the SKIP button (◀◀ or ▶▶) to find the folder that the track you want to listen to is included.

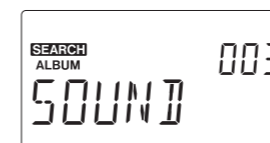
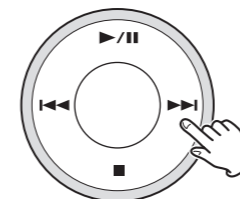

3 Press and hold the SKIP button (◀◀ or ▶▶).

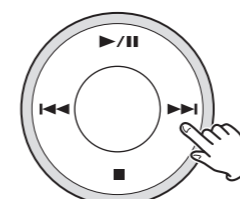

Then you can select the track in the folder by pressing the SKIP button (◀◀ or ▶▶).

4 Press the PLAY/PAUSE button (▶/||) to start playback.

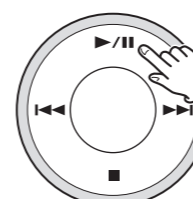

Playback starts from the selected track.

- If you skip step 3, playback will start from the first track in the selected folder.

Shuffle Playback

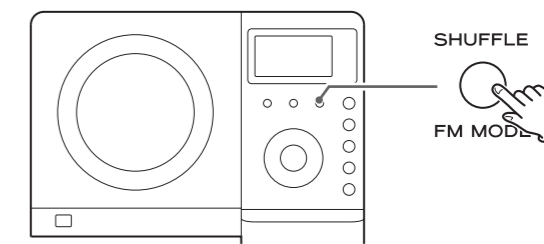

The tracks can be played randomly. Press the SHUFFLE button during playback or when in the stop mode. "SHUFFLE" will then light up in the display.

- If you press the ▶▶ button during shuffle playback, next track will be randomly selected and played. If you press the ◀◀ button, the currently played track will be played from the beginning. If you press the ◀◀ button twice or more, next track will be randomly selected and played. A track cannot be replayed during shuffle playback.
- Shuffle playback doesn't work during programmed playback.
- If one of the following buttons is pressed, shuffle mode will be cancelled:

SHUFFLE, STOP, FUNCTION, FM/AM
STANDBY/ON, OPEN/CLOSE

Search Mode (MP3 only)

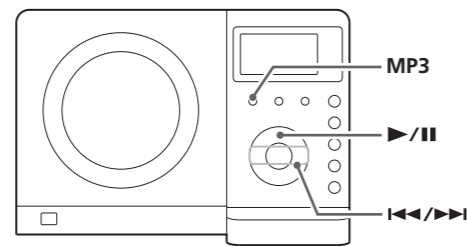

Search for a name of track

You can select the track by searching for its name.

1 Press the MP3 button once.

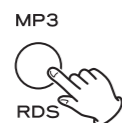

An alphabet (initial letter of a track name) and a track number are displayed.

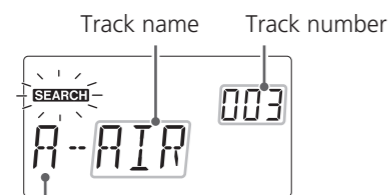

Initial letter of track name

- To cancel the search mode, press the STOP button (■).

2 Select the initial letter of the track you want to listen to by pressing the SKIP button (◀ or ▶).

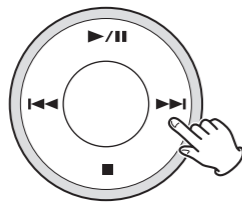

3 Press and hold the SKIP button (◀ or ▶).

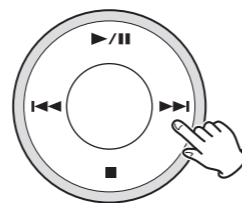

Then you can select the track that has same initial letter by pressing the SKIP button (◀ or ▶).

4 Press the PLAY/PAUSE button (▶/||).

Playback starts from the selected track.

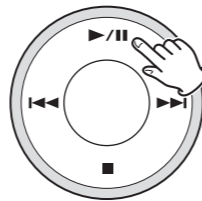

To go back to the previous menu

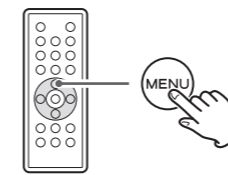

Press the MENU button to go back to the previous menu. This button is equivalent to the MENU button on your iPod.

Select the menu item

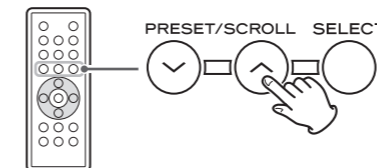

Press the PRESET/SCROLL buttons (∨/∧) to scroll to the menu item you want, and then press the SELECT button.

To activate the shuffle mode

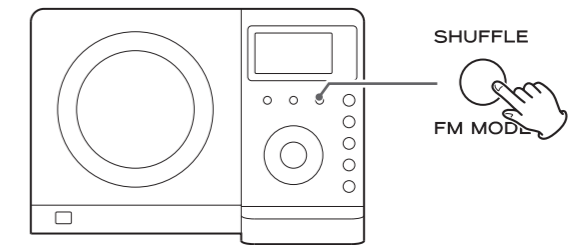

During playback, press the SHUFFLE button to change the shuffle mode.

Each time the SHUFFLE button is pressed, the SHUFFLE setting of iPod is changed as follows:

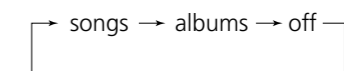

If iPod is set to shuffle songs or albums, the Shuffle icon (∞) appears in the iPod's display.

To activate the repeat mode

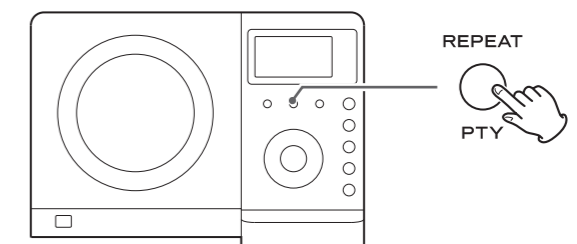

During playback, press the REPEAT button to change the repeat mode.

Each time the REPEAT button is pressed, the REPEAT setting of iPod is changed as follows:

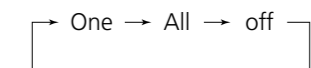

If the iPod is set to repeat one song, the Repeat One icon (🔁) appears in the iPod's display.

If the iPod is set to repeat all songs, the Repeat icon (🔁) appears in the iPod's display.

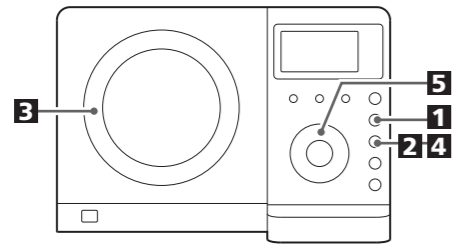

1 Press the **FUNCTION** button to select "CD".

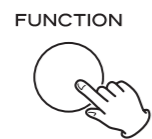

2 Press the **OPEN/CLOSE** button.



3 Put a disc onto the center spindle of the player with the label side facing you.

Press the disc onto the spindle until a slight "click" is heard indicating the disc is mounted correctly.

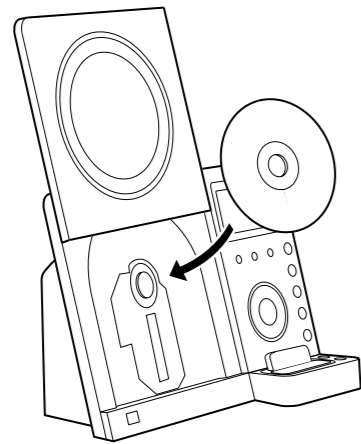

- Never put more than one disc in the mechanism at a time.
- Ensure that the disc is correctly mounted on the spindle and locked in place.

4 Press the **OPEN/CLOSE** button to close the CD door.



- It takes a few seconds for the unit to load the disc. No buttons will work during loading. Wait until the total number of the tracks and the total play time of the disc are displayed.

- When no disc is loaded in the CD player, "NO DISC" is displayed.

When a CD is loaded

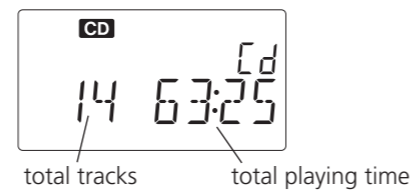

When a MP3 disc is loaded



5 Press the **Play/Pause** button (▶/||) to start playback.

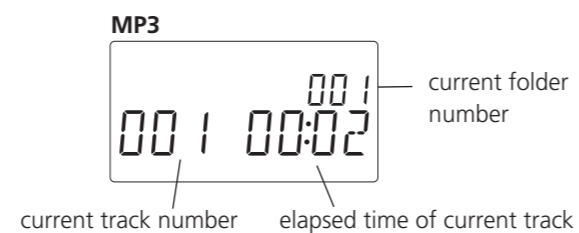
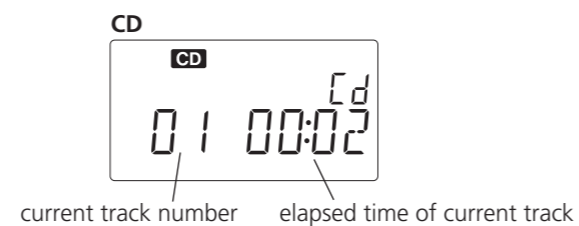
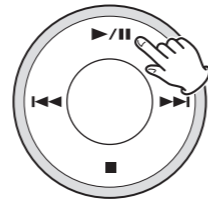

Playback starts from the first track of the disc.

- MP3 tracks recorded out of folders are automatically put in the "ROOT" folder, and playback starts from the first track of the ROOT folder.
- When the playback of all the tracks has finished, the unit stops automatically.

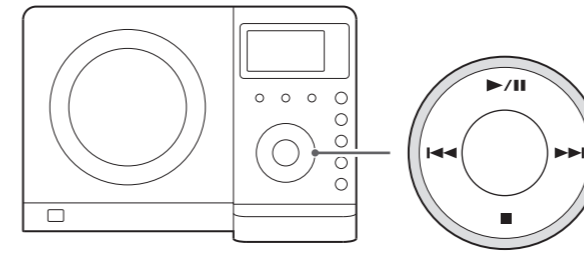

To suspend playback temporarily (pause mode)

Press the Play/Pause button (▶/||) during playback. Playback stops at the current position. To resume playback, press the Play/Pause button (▶/||) again.

To stop playback

Press the Stop button (■) to stop playback.

To skip to the next or a previous track

During playback, press the skip button (◀◀ or ▶▶) repeatedly until the desired track is found. The selected track will be played from the beginning.

In the stop mode, press the skip button (◀◀ or ▶▶) repeatedly until the track you want to listen to is found. Press the Play/Pause button (▶/||) to start playback from the selected track.

- When the ◀◀ button is pressed during playback, the track being played will be played from the beginning. To return to the beginning of the previous track, press the ◀◀ button twice.
- During programmed playback, the next or previous track in the program is played.

Search for a part of a track

During playback, hold down the skip button (◀◀ or ▶▶) and release it when the part you want to listen to is found.

To display MP3 information

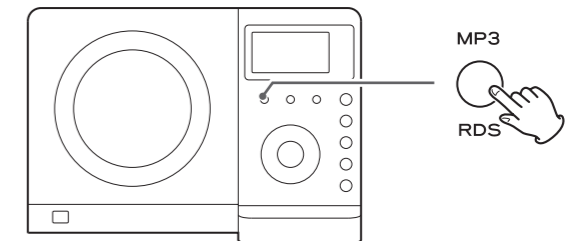

During playback of an MP3 disc, press the MP3 button for more than 1 second. The information about the current track is displayed as follows:

Filename → Title → Artist → Album

- NONE appears when there is no information.
- UNKNOWN appears when the unit cannot read the information.

Press the MP3 button for more than 1 second again to cancel the MP3 information mode.

Select a folder on the MP3 disc

Press the PRESET/SCROLL button to select a folder.

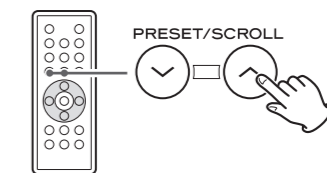

Free Manuals Download Website

<http://myh66.com>

<http://usermanuals.us>

<http://www.somanuals.com>

<http://www.4manuals.cc>

<http://www.manual-lib.com>

<http://www.404manual.com>

<http://www.luxmanual.com>

<http://aubethermostatmanual.com>

Golf course search by state

<http://golfingnear.com>

Email search by domain

<http://emailbydomain.com>

Auto manuals search

<http://auto.somanuals.com>

TV manuals search

<http://tv.somanuals.com>