

TEAC

MC-DX25

Micro Hi-Fi System

OWNER'S MANUAL

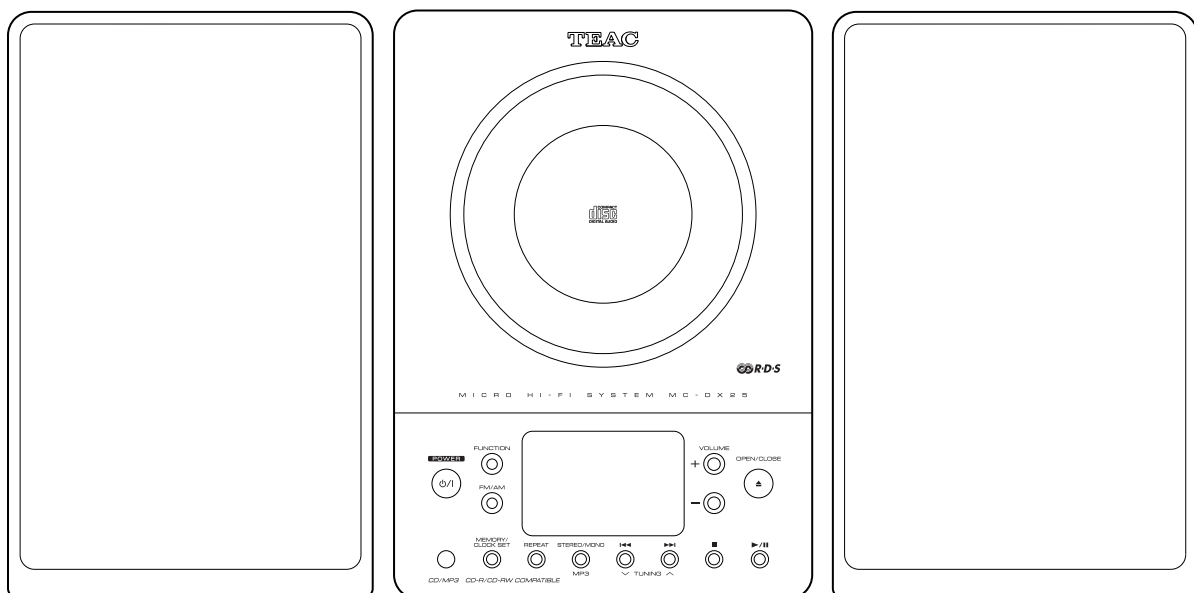

Contents

Thank you for choosing TEAC. Read this manual carefully to get the best performance from this unit.

Before Use	2
Discs	3
Connection	4
Wall Mounting	5
Names of Each Control	6
Remote Control Unit	7
Basic Operation	8
Listening to CD/MP3	9
Search Mode (MP3 only)	11
Programmed Playback	12
Repeat Playback	14
Shuffle Playback	14
Listening to the Radio	15
Preset Tuning	16
RDS	17
RDS (PTY Search)	18
Setting the Clock	19
Setting the Timer	20
Troubleshooting	22
Specifications	23

VARNING: APPARATEN INNEHÅLLER LASER KOMPONENT MED STRÅLNING ÖVERSTIGANDE KLASS 1.

'ADVASEL: USYNLIG LASERSTRÅLING VED ÅBNING NAR SIKKERHEDSAFBRYDERE ER UDE AF FUNKTION. UNDGÅ UDSAETTEELSE FOR STRÅLING'

'VAROITUS! SUOJAKOTELOA EI SAA AVATA. LAITE SISÄLTÄÄ LASERDIODIN. JOKA LÄHETTÄ (NÄKYMÄTÖNTÄ) SILMILLE VAARALLISTA LASERSÄTEILYÄ'.

ADVASEL: USYNLIG LASERBESTRÅLING NÅR DENNE DELEN ER ÅPEN OG SIKKERHETSSPERREN ER UTKOBLET UNNGÅ UTSETTELSE FOR STRÅLING.



trademark of New Transducers Ltd.

Before Use

Read this before operation

- As the unit may become warm during operation, always leave sufficient space around the unit for ventilation.
- The voltage supplied to the unit should match the voltage as printed on the rear panel of the supplied subwoofer. If you are in any doubt regarding this matter, consult an electrician.
- Choose the installation location of your unit carefully. Avoid placing it in direct sunlight or close to a source of heat. Also avoid locations subject to vibrations and excessive dust, heat, cold or moisture.
- Do not place the unit on an amplifier/receiver or any other electronic device that generates heat.
- Do not open the sealed cabinet as this might result in damage to the circuitry or electrical shock. If a foreign object should get inside the unit, contact your dealer or service agency.
- When removing the power plug from the wall outlet, always pull directly on the plug, never yank the cord.
- To keep the laser pickup clean, do not touch it, and always close the CD door.
- Do not attempt to clean the unit with chemical solvents as this might damage the finish. Use a clean, dry cloth.
- Keep this manual in a safe place for future reference.

DO NOT MOVE THE UNIT DURING PLAYBACK

During playback, the disc rotates at high speed. Do NOT lift or move the unit during playback. Doing so may damage the disc or the laser assembly.

WHEN MOVING THIS UNIT

When relocating or packing the unit for moving, be sure to remove the disc. Moving this unit with the disc loaded may result in damage to this unit.

CAUTION

Do not expose this unit to liquids of any kind. Keep any objects containing liquids such as vases, water glasses, potted plants, et cetera off the top of this unit.

Do not install this equipment in a confined space such as a bookcase or similar unit.

Discs that can be played on this unit:

- Commercial audio CD's bearing the 'Compact Disc Digital Audio' logo:



- Properly finalized CD-R and CD-RW discs

Note:

- Depending on the quality of the disc and/or the condition of the recording, some CD-R discs may not be playable.
- Copy-protected discs and other discs which do not conform to the CD standard may not play back correctly in this player. If you use such discs in this unit, TEAC Corporation and its subsidiaries cannot be responsible for any consequences or guarantee the quality of reproduction. If you experience problems with such non-standard discs, you should contact the producers of the disc.
- Always load the disc with the label side facing you. (Compact discs can be played or recorded only on one side.)
- To remove a disc from its storage case, press down on the center of the case and lift the disc out, holding it carefully by the edges.



How to remove the disc



How to hold the disc

- Should the disc become dirty, wipe the surface radially with a soft, dry cloth. Never clean the disc using a circular motion.



- Never use such chemicals as record sprays, antistatic sprays or fluid, benzene or thinner to clean the discs. Such chemicals will do irreparable damage to the disc's plastic surface.
- Discs should be returned to their cases after use to avoid dust and scratches that could cause the laser pickup to 'skip.'
- Do not expose discs to direct sunlight or high humidity and temperature for extended periods. Long exposure to high temperatures will warp the disc.
- CD-R discs are more sensitive to the effects of heat and ultraviolet rays than ordinary CDs. It is important that they are not stored in a location where direct sunlight will fall on them and which is away from sources of heat such as radiators or heat-generating electrical devices.

- Printable CD-R discs aren't recommended, as the label side might be sticky and damage the unit.
- Do not stick papers or protective sheets on the discs and do not use any protective coating spray.
- Use a soft oil-based felt-tipped pen to write the information on the label side. Never use a ball-point or hard-tipped pen, as this may cause damage to the recorded side.
- Never use a stabilizer. Using commercially available CD stabilizers with this unit will damage the mechanisms and cause them to malfunction.
- Do not use irregular shape CDs (octagonal, heart-shape, etc.). CDs of this sort can damage the unit.

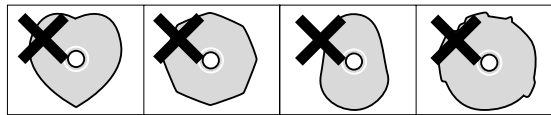

- If you are in any doubt as to the care and handling of a CD-R/CD-RW disc, read the precautions supplied with the disc, or contact the disc manufacturer directly.

MP3 compatibility

- File names of MP3 should be alphanumeric characters. This unit cannot display symbols and full-size or 2 bytes-wide characters (such as Japanese, Chinese, etc.) correctly. Also, be sure to use the file extension '.mp3'.
- The disc must be finalized in order to play.
- The CD-ROM must be ISO 9660 compatible.
- When more than 200 files or folders are recorded on the disc, the unit might not be able to play it correctly.
- Mono or stereo MPEG-1 Audio Layer 3 format, 44.1 or 48 kHz, fixed bit-rate.
- Audio encoded at 128 Kbps should sound close to regular audio CD quality. Although this player will play lower bit-rate MP3 tracks, the sound quality becomes noticeably worse at lower bit-rates.

Connection

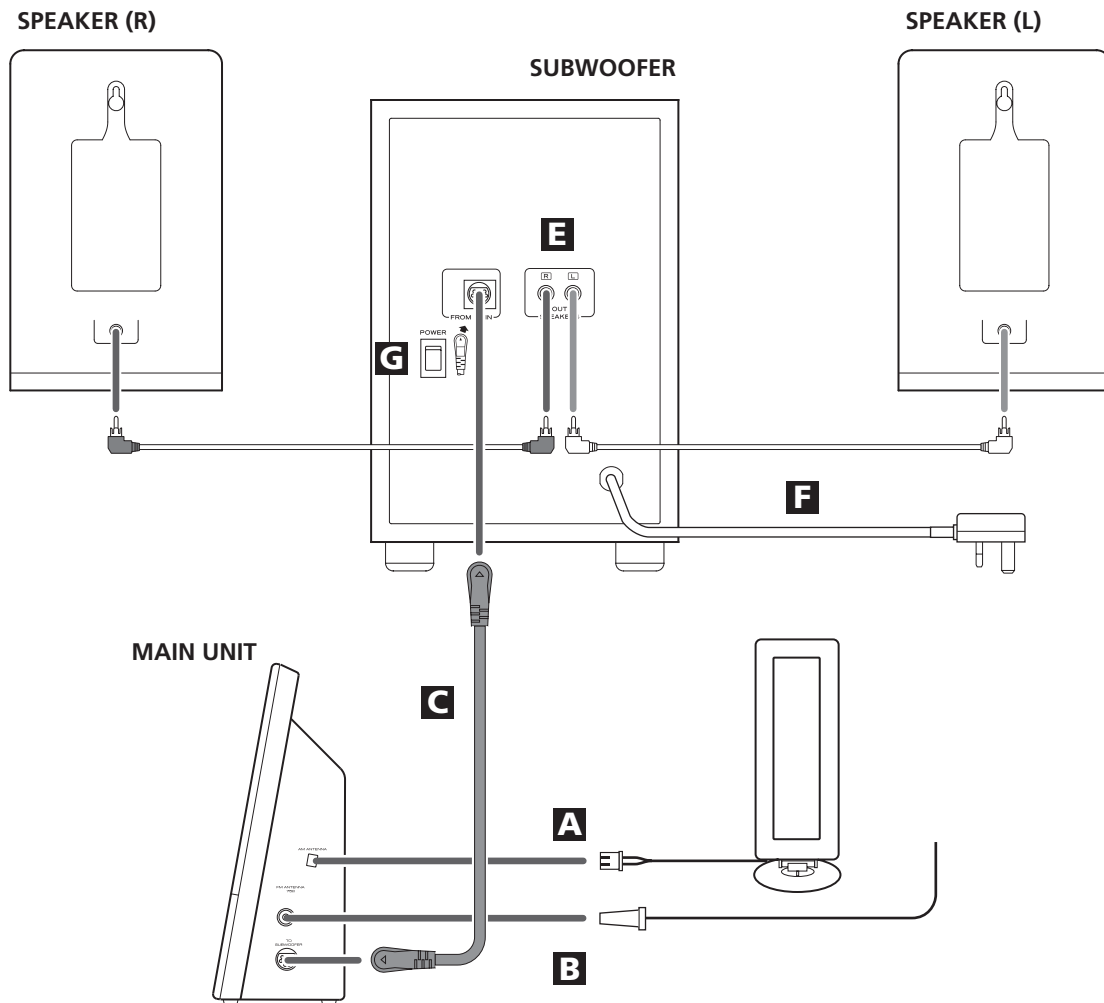

CAUTION

Turn off the power of all the equipment before making connections.
Read instructions of each component you intend to use with this unit.

- Be sure to insert each plug securely. To prevent hum and noise, do not bundle the connection cords with the power cord.

A AM loop antenna

Position the antenna for the best sound.
If you want, you can hook the AM antenna on a wall as shown below:

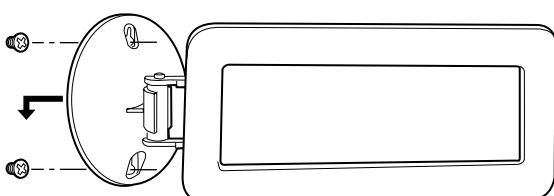

B FM antenna

While in FM mode, tune in an FM station and extend the lead to find the best position for reception. This antenna may need to be repositioned if you move your unit to a new location.

FM Outdoor Antenna

In an area where FM signals are weak, it will be necessary to use a 75-ohm unbalanced-type outdoor FM antenna using an optional (not supplied) matching transformer connected to an external antenna. Generally, a 3-element antenna will be sufficient; if you live in an area where the FM signals are particularly weak, it may be necessary to use one with 5 or more elements.

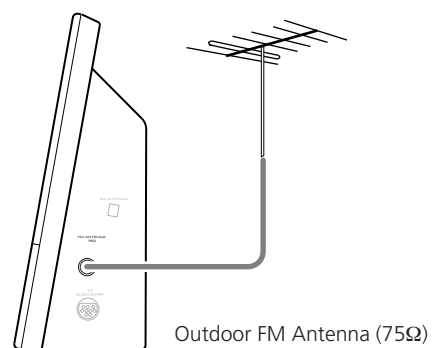

C Subwoofer

Make the connection between the 'TO SUBWOOFER' and 'FROM MAIN' sockets using the supplied cable.

D AUX IN

You can connect a DVD player, VCR etc. to this unit. Connect the component with RCA pin cords. Make sure to connect the white plug to the white jacks (Left) and the red plug to the red jacks (Right).

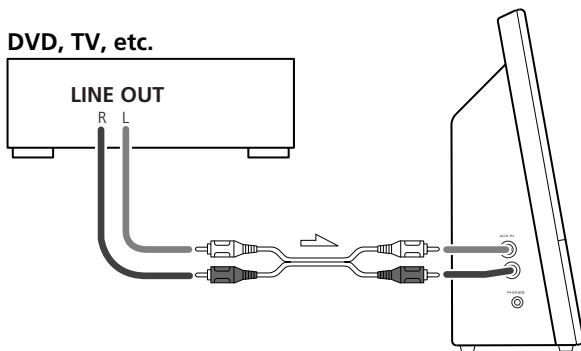

E SPEAKERS

Connect the left speaker's plug to L, and the right speaker's plug to R.

- When using speakers other than those supplied with the system, the impedance should be 3 ohms or more.
- Do not connect anything other than speakers to these terminals.

F AC Power Cord

Plug this AC power cord into an AC wall socket.

G Power Switch

Use this switch to turn the system on or off. The main unit is powered via the subwoofer. You need to first turn this switch on.

Wall Mounting

You can mount the main unit and/or the left and right speakers on a wall.

Precautions

- Be aware that the length of the cables are approximately 3 m. Do not attempt to mount the main unit and the speakers too far from the subwoofer.
- Drill holes into solid wall support, such as wooden frame or concrete wall.
- TEAC supplies these brackets as a convenience to the product owner. Consult your local building codes and exercise all necessary caution when mounting these brackets. If you are unsure how to use the supplied brackets, consult with a local tradesmen or building supply expert.

To hook on the wall

- 1 Use the supplied template to determine drilling points.
 - 2 Secure the brackets on the wall using the supplied screws.
- As a convenience, a set of tapered plastic anchors is supplied. If you chose to use these anchors, drill a pilot hole using either a 6mm drill bit then tap the anchor into the pilot hole. Only use these anchors if they are appropriate for the materials onto which the unit is to be mounted. Consult your local hardware store if you are uncertain.

Note:

Before going on, make connections between the main unit and the speakers by referring to page 4-5.

- 3 Hang the main unit and/or the speakers to the mounting tabs.

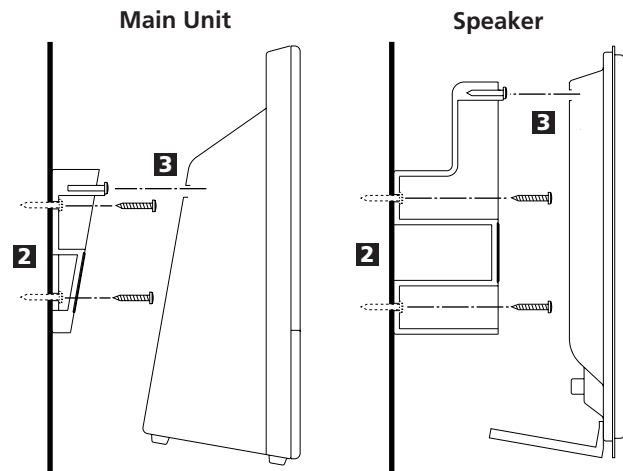

Names of Each Control

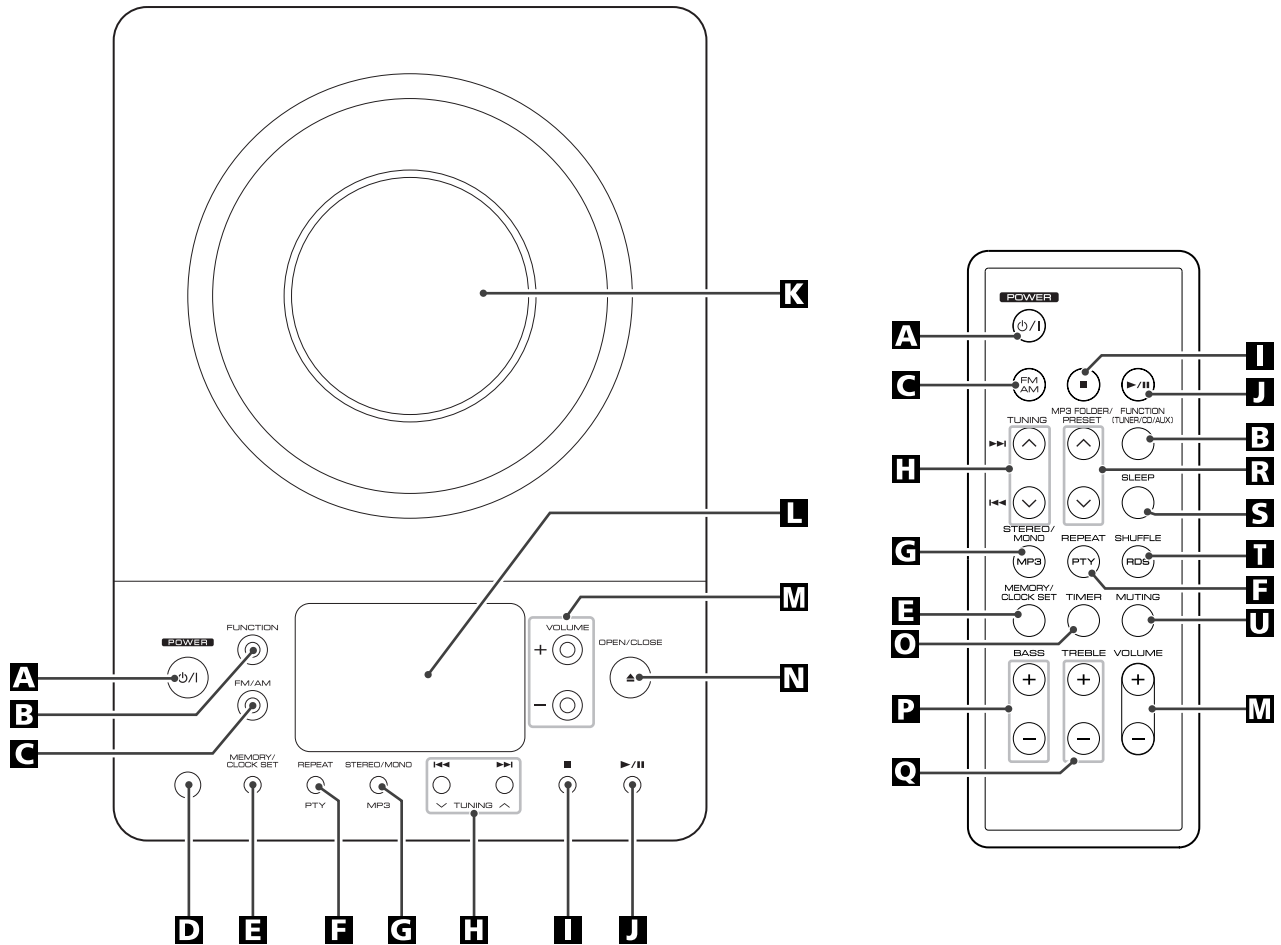

A POWER

Press this switch to turn the unit on or off (standby).
The main unit is powered via the subwoofer. You need to first turn on the subwoofer.

The equipment draws a nominal amount of power from the AC outlet even with its POWER switch in the OFF position.

B FUNCTION

Use this button to select a source (CD, AUX or TUNER).

C FM/AM

Use this button to select AM or FM.

D Remote Sensor

When operating the remote control unit, point it towards the remote sensor.

E MEMORY/CLOCK SET

In CD mode, use this button to program tracks.
In TUNER mode, use this button to store preset channels into memory.
This button is also used for clock adjustment.

F REPEAT/PTY

In CD mode, use this button for repeat playback.
In FM TUNER mode, use this button to start PTY search.

G STEREO/MONO/MP3

In FM TUNER mode, use this button to select stereo or monaural.
During playback of a MP3 disc, use this button to search track name.
During playback of CD, use this button to switch the ESP function on or off.

H SKIP (◀◀ / ▶▶) / TUNING

In CD mode, momentarily press this button to skip tracks.
Hold down this button to search for a part of a track.
In TUNER mode, momentarily press this button to tune in stations.
In Standby mode, these buttons are used to set or adjust the clock and the timer.

I STOP (■)

Use this button to stop playback of CD/MP3.

J PLAY/PAUSE (▶/II)

Use this button to start or pause playback of CD/MP3.

K CD door

L Display

M VOLUME

Press the up '+' or the down '-' button to adjust the volume.

N OPEN/CLOSE

Use this button to open and close the CD door.

O TIMER

Use this button together with the SKIP buttons to set the timer.

P BASS

Use these buttons to adjust the bass sound up or down.

Q TREBLE

Use these buttons to adjust the treble sounds up and down.

R MP3 FOLDER/PRESET

In TUNER mode, use this button to select preset stations.
During playback of a MP3 disc, use this button to select a folder in the disc.

S SLEEP

Use this button to set sleep timer.

T SHUFFLE/RDS

Use this button for shuffle playback.
In FM TUNER mode, use this button to select an RDS mode.

U MUTING

Use this button to mute the sound.

Note:

To simplify explanations, instructions refer to names of buttons and controls on the front panel, making no mention of the use of remote control unit.

Remote Control Unit

The provided Remote Control Unit allows the unit to be operated from a distance.

When operating the remote control unit, point it towards the remote sensor on the front panel of the unit.

- Even if the remote control unit is operated within the effective range, remote control operation may be impossible if there are any obstacles between the unit and the remote control.
- If the remote control unit is operated near other products which generate infrared rays, or if other remote control devices using infrared rays are used near the unit, it may operate incorrectly. Conversely, the other products may also operate incorrectly.

Battery Installation

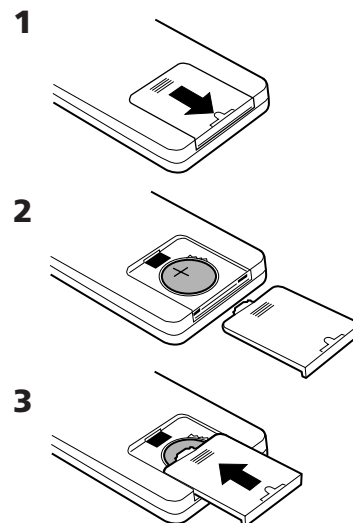

1 Remove the battery compartment cover.

2 Put in the lithium battery (CR2032, 3V).

3 Close the cover.

Battery Replacement

If the distance required between the remote control unit and main unit decreases, the battery is exhausted. In this case, replace the battery with a new one.

Precautions concerning batteries

- Do not heat or disassemble batteries and never dispose of old batteries by throwing them in a fire.

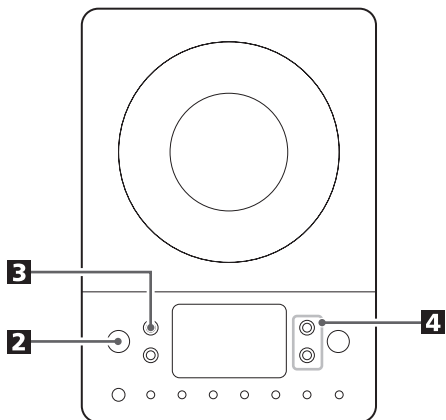

1 Turn on the subwoofer.

2 Press the POWER switch on the main unit.



3 Select a source by pressing the FUNCTION button.

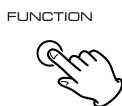

4 Play the source and adjust the volume using the VOLUME buttons.

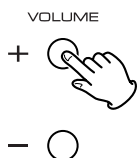

Muting

To mute the sound temporarily, press the MUTING button. Press the MUTING button again to restore the sound.

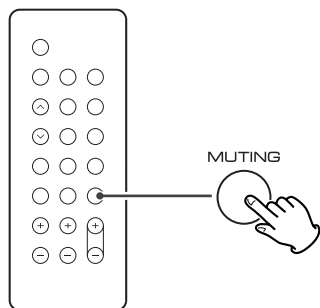

- While muting is engaged, the VOLUME level indicators blink.

Headphones

For private listening, insert the headphones plug into the PHONES jack, and adjust the volume using the VOLUME buttons. The sound from the speakers is cut off while the headphone jack is inserted.

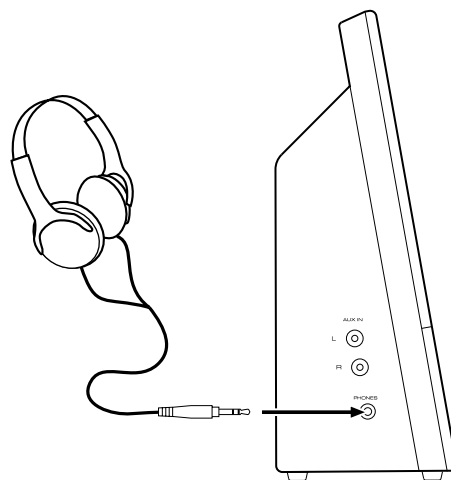

Sleep Timer

Repeatedly pressing the SLEEP button permits setting an interval (from 90 down to 10 minutes) after which you want the unit to automatically turn off and shift into Standby mode.

Each press of the SLEEP button changes the time indication by 10 minutes.

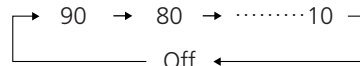
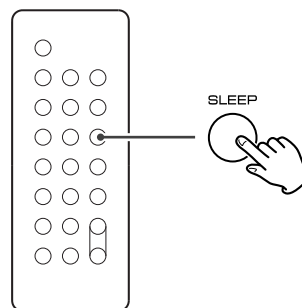

Listening to CD/MP3 (1)

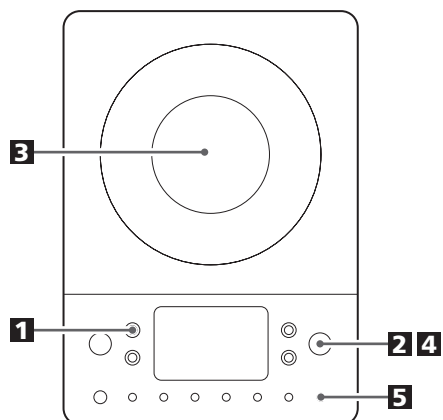

1 Press the **FUNCTION** button to select 'CD'.



2 Press the **OPEN/CLOSE** button.

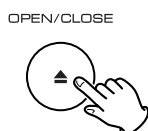

3 Put a disc onto the center spindle of the player with the label side facing you.

Press the disc onto the spindle until a slight 'click' is heard indicating the disc is mounted correctly.

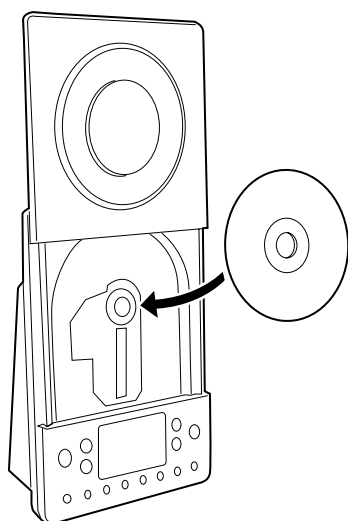

4 Press the **OPEN/CLOSE** button to close the CD door.



- It takes a few seconds for the unit to load the disc. No buttons will work during loading. Wait until the total number of the tracks and the total play time of the disc are displayed.
- When no disc is loaded in the CD player, 'NO DISC' is displayed.

When a CD is loaded

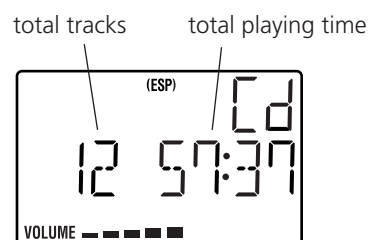

When a MP3 disc is loaded

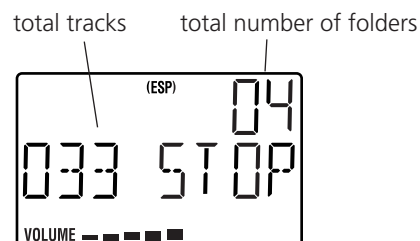

5 Press the **Play/Pause** button (▶/||) to start playback.



Playback starts from the first track of the disc.

- MP3 tracks recorded out of folders are automatically put in the 'ROOT' folder, and playback starts from the first track of the ROOT folder.
- When the playback of all the tracks has finished, the unit stops automatically.

- Never put more than one disc in the mechanism at a time.
- Ensure that the disc is correctly mounted on the spindle and locked in place.

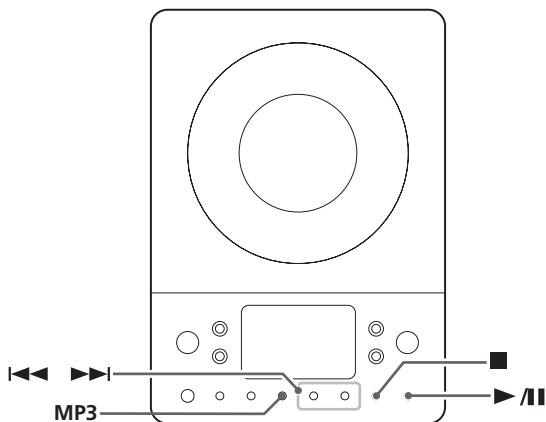

To suspend playback temporarily (pause mode)



Press the Play/Pause button (▶/||) during playback. Playback stops at the current position. To resume playback, press the Play/Pause button (▶/||) again.

To stop playback

Press the Stop button (■) to stop playback.



To skip to the next or a previous track



During playback, press the skip button (I◀◀ or ▶▶I) repeatedly until the desired track is found. The selected track will be played from the beginning.

In the stop mode, press the skip button (I◀◀ or ▶▶I) repeatedly until the track you want to listen to is found. Press the Play/Pause button (▶/||) to start playback from the selected track.

- When the I◀◀ button is pressed during playback, the track being played will be played from the beginning. To return to the beginning of the previous track, press the I◀◀ button twice.
- During programmed playback, the next or previous track in the program is played.

Search for a part of a track

During playback, hold down the skip button (I◀◀ or ▶▶I) and release it when the part you want to listen to is found.



ESP (Electronic Shock Protection)



The ESP stores the music in the buffer to prevent sound from skipping.

During playback of a CD, press the MP3 button to turn the ESP on or off. When you turn the ESP on, '40 SEC (40 seconds)' briefly appears, and the (ESP) indicator lights on the display.

- The (ESP) indicator blinks while the unit is filling the buffer.
- When the unit is on the stable place and free from mechanical shocks, you can turn this function off.
- During playback of MP3, this function is always ON.

To display the MP3 information



During playback of MP3 disc, press the MP3 button for more than 1 second. The information about the current track is displayed as follows:

FILE (folder name)→TITLE (*)→ARTIST (*)→ALBUM (*)
*: track information

Press the MP3 button for more than 1 second again to cancel the MP3 information mode.

Skip to the next folder (MP3)

Press the MP3 FOLDER button to skip to next folder.

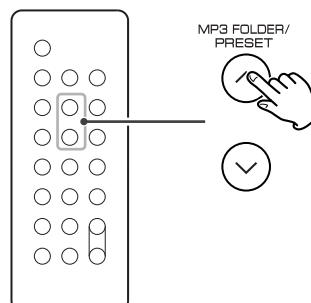

Search Mode (MP3 only)

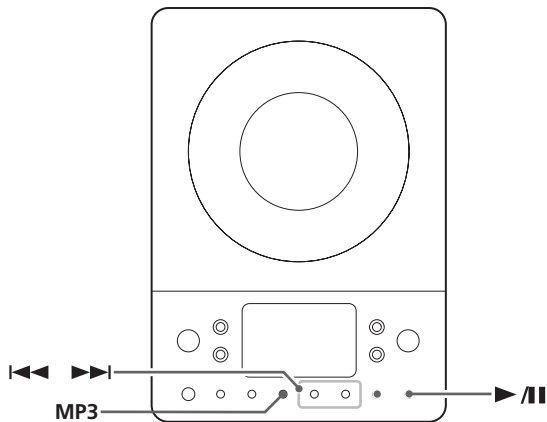

Search for a name of track

You can select the track by searching for its name.

- 1 Press the MP3 button once.



An alphabet (initial letter of a track name) and a track name are displayed.

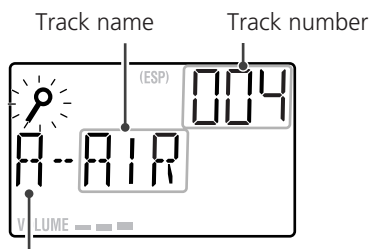

- To cancel the search mode, press the STOP button (■).

- 2 Select the initial letter of the track you want to listen to by pressing the SKIP button (◀◀ or ▶▶).



- 3 Press and hold the SKIP button (◀◀ or ▶▶).



- 4 Press the PLAY/PAUSE button (▶/||).

Playback starts from the selected track.



Search for a track in a folder

- 1 Press the MP3 button twice.



The name of folder is displayed.

- 2 Press the SKIP button (◀◀ or ▶▶) to find the folder that the track you want to listen to is included.

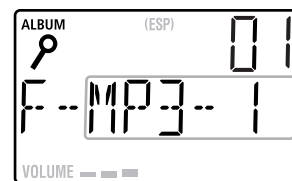

- 3 Press and hold the SKIP button (◀◀ or ▶▶).

Then you can select the track in the folder by pressing the SKIP button (◀◀ or ▶▶).

- MP3 tracks recorded out of folders are in the 'ROOT' folder.

- 4 Press the PLAY/PAUSE button (▶/||) to start playback.



Playback starts from the selected track.

- If you skip step 3, playback will start from the first track in the selected folder.

Programmed Playback

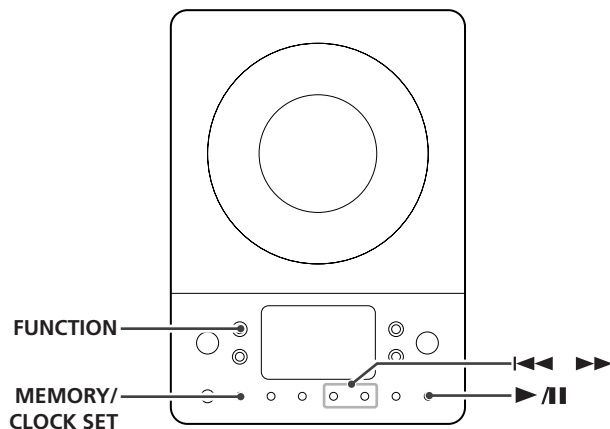

Up to 64 tracks can be programmed in the desired order.

Shuffle and Repeat functions don't work during programmed playback.

1 Press the FUNCTION button to select 'CD'.



2 Press the MEMORY button.

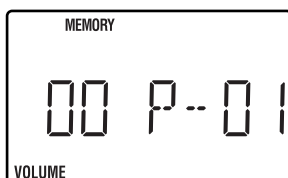

'MEMORY' lights up in the display.

- To cancel the program mode, press the Stop button (■).

3 Press the Skip button (◀◀ or ▶▶) repeatedly to select a folder of a MP3 disc, then press the MEMORY button.

- MP3 tracks recorded out of folders are in the '01' (ROOT) folder.
- Skip this step when playing a CD.

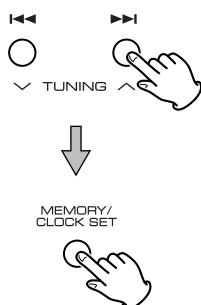

4 Press the Skip button (◀◀ or ▶▶) repeatedly to select a track, then press the MEMORY button.

The track is programmed, and 'P-02' is displayed.

- Repeat steps **3** and **4** to program more tracks.
- You can program up to 64 tracks.

5 When the selection of track numbers is completed, press the Play/Pause button (▶/||) to start program playback.



- When the playback of all the programmed tracks has finished, or if one of the following buttons is pressed, the MEMORY indicator will go off and the program mode will be cancelled:

STOP, FUNCTION, POWER

The program is retained in memory until the OPEN/CLOSE button is pressed or the power is interrupted. You can return to the programmed playback by pressing the MEMORY button and the Play/Pause button (▶/||). (If another source was selected, select the CD mode by pressing the FUNCTION button beforehand.)

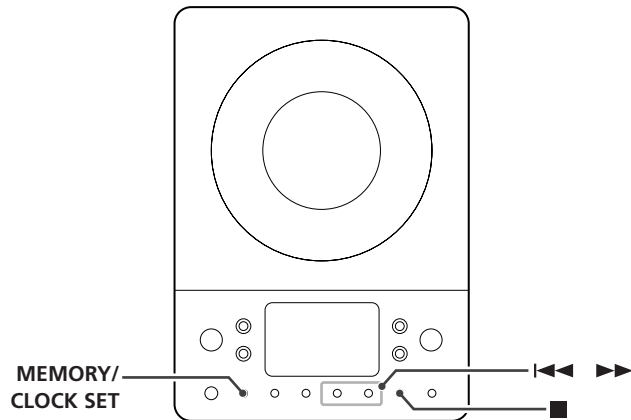

To check the programmed order



In the stop mode, press the MEMORY button repeatedly. The track number and program number will be shown on the display.

To add a track to the end of the program

In the stop mode, press the MEMORY button repeatedly until '00' appears on the display. Select a track number using the Skip button (I◀◀ or ▶▶I) and then press the MEMORY button. The track is added to the end of the program.

To overwrite the program

In the stop mode, press the MEMORY button repeatedly until the program number to be changed appears on the display. Select a new track number using the Skip button (I◀◀ or ▶▶I) and then press the MEMORY button.



To clear program

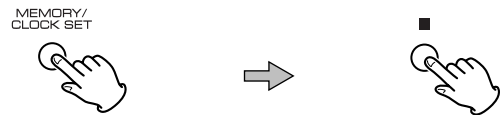

To clear the programmed contents, press the MEMORY and the STOP button (■) in the stop mode.

- If the OPEN/CLOSE button is pressed, the programmed contents will also be cleared.
- If the unit is disconnected from the power supply, the programmed contents will be cleared.

Repeat Playback

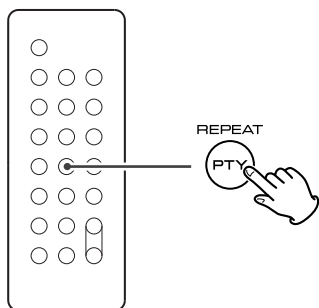

Every time the REPEAT button is pressed, the mode is changed as follows:

When a CD is loaded.

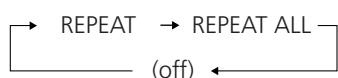

When a MP3 disc is loaded.

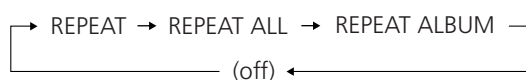

- If one of the following buttons is pressed, repeat mode will be canceled:
STOP, FUNCTION, OPEN/CLOSE, POWER

Repeat one track

Press the REPEAT button once during playback. 'REPEAT' lights.

The track being played will be played repeatedly. If you press the Skip button (I◀◀ or ▶▶I) and select another track, the track you selected will be played repeatedly.

It is also possible to select a track to be repeated in the stop mode. Press the REPEAT button, select a track using the Skip button (I◀◀ or ▶▶I), and then press the Play/Pause button (▶/||) to start playback.

Repeat all the tracks

All the tracks will be played repeatedly.
Press the REPEAT button twice. 'REPEAT ALL' lights.

During programmed playback, programmed tracks will be played repeatedly.

Repeat all the tracks in the folder (MP3)

All the tracks in the folder will be played repeatedly.
Press the REPEAT button three times. 'REPEAT ALBUM' lights.

Shuffle Playback

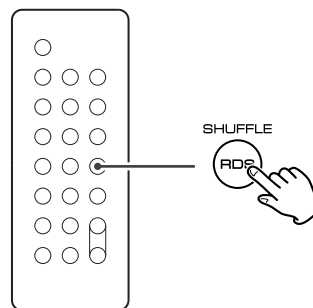

The tracks can be played randomly. Press the SHUFFLE button during playback or when in the stop mode. 'SHUFFLE' will then light up in the display.

- If you press the ▶▶I button during shuffle playback, next track will be randomly selected and played. If you press the I◀◀ button, the currently played track will be played from the beginning. A track cannot be replayed during shuffle playback.
- Shuffle playback doesn't work during programmed playback.
- If one of the following buttons is pressed, shuffle mode will be cancelled:

SHUFFLE, STOP, FUNCTION, POWER, OPEN/CLOSE

Listening to the Radio

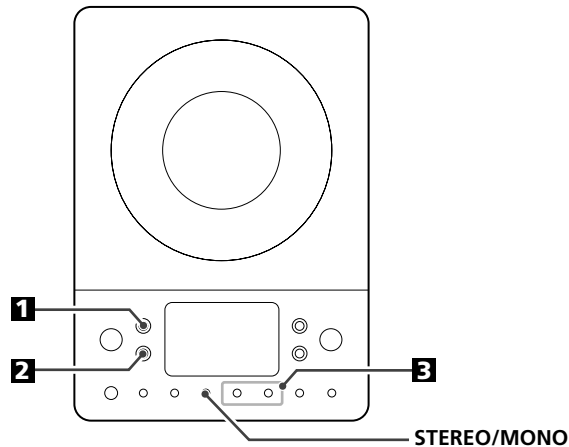

1 Press the FUNCTION button to select 'TUNER'.



2 Press the FM/AM button to select a band.



3 Select the station you want to listen to (auto selection).



Hold down the TUNING Up or Down button until the frequency display begins to change. When a station is tuned in, the tuning process will stop automatically.

- Press the Up or Down button to stop the auto selection.

Selecting stations which cannot be tuned automatically (manual selection)

When the Up or Down button is pressed momentarily, the frequency changes by a fixed step.

Press the Up or Down button repeatedly until the station you want to listen to is found.

STEREO/MONO button



Pressing this button alternates between STEREO mode and MONO mode.

STEREO

FM stereo broadcasts are received in stereo and the 'STEREO' indicator will light.

MONO

In weak FM stereo reception areas, select this mode. Reception will now be forced to monaural, reducing unwanted noise.

If the reception is poor

Reposition the AM or FM antenna for the best possible reception. It may also be necessary to connect an external antenna in extremely weak reception areas (see page 4).

Preset Tuning

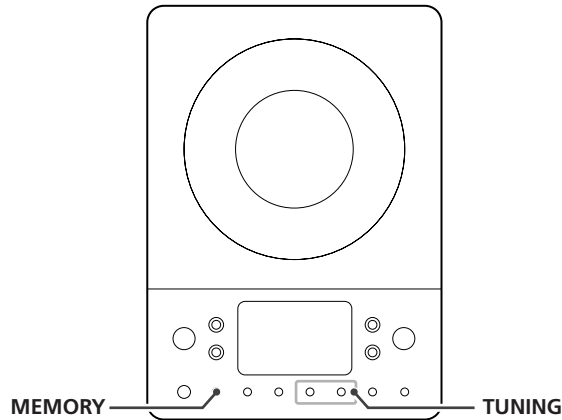

You can store FM and AM stations into preset channels 1 to 10 respectively.

If the power switch of the subwoofer turned off, the settings kept in memory (clock, preset stations, timer setting) will be erased.

1 Tune in a station you want to listen to (see steps **1** to **3** of page 15).

2 Press the MEMORY button.

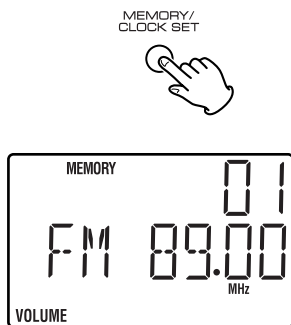

3 Within 5 seconds, select a preset channel to store the station using the TUNING buttons.

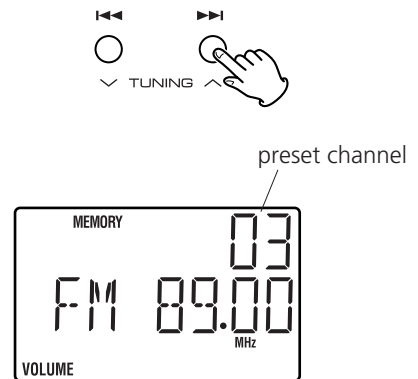

4 Within 5 seconds, press the MEMORY button.



The station is stored and the MEMORY indicator goes off. To store more stations, repeat steps **1** to **4**.

How to select preset stations

1 Press the FM/AM button to select a band.

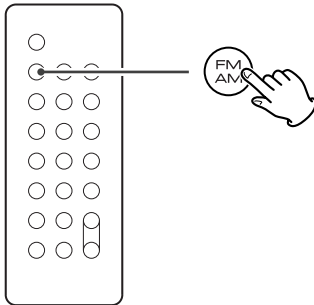

2 Press the PRESET button repeatedly until the desired preset station is found.

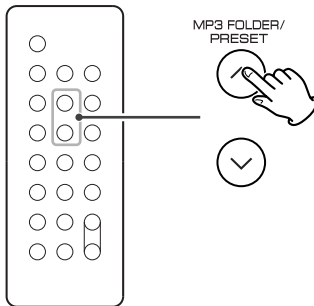

The Radio Data System (RDS) is a broadcasting service which allows stations to send additional information along with the regular radio programme signal.

RDS works on the FM waveband in Europe only.

1 Tune in an FM RDS station (see steps **1** to **3** of page 15).

The RDS indicator lights, and the Programme Service name (station's name) appears on the display.

2 Press the RDS button.

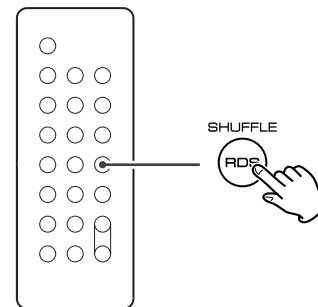

Each time the RDS button is pressed, the RDS mode is changed as follows:

PS (Programme Service name)

When you select PS, the frequency will be displayed for 3 seconds, and then PS (station's name) will be displayed. If there is no PS data, 'NO PS' will be displayed.

PTY (Programme Type)

When you select PTY, the programme type will be displayed. If there is no PTY data, 'NO PTY' will be displayed.

RT (Radio Text)

When you select RT, the news of stations composed of up to 64 symbols will be displayed. If there is no RT data, 'NO RT' will be displayed.

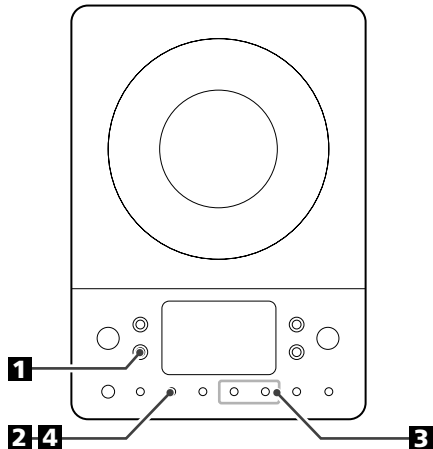

A station can be searched by this function.

1 Select FM by pressing the FM/AM button.



2 Press the PTY button.



'PTY SEL' blinks on the display.

3 Within 10 seconds, select the desired PTY programme using the SKIP buttons.



You can select from 29 kinds.

4 Press the PTY button.



Searching will start.

- When the programme that you have selected is found, searching will stop and the programme type will be displayed.
- If the same program type is not found during PTY Search, it will stop at the beginning frequency.
- If you want to stop searching, press the PTY button.

- NEWS : brief announcements, events, public opinion, reports, actual situations.
- AFFAIRS : a kind of suggestion including practical announcements other than news, documents, discussion, analysis and so on.
- INFO : daily information or reference such as weather forecast, consumer guide, medical assistance and so on.
- SPORT : sports related programs.
- EDUCATE : educational and cultural information.
- DRAMA : all kinds of radio concert and serial drama.
- CULTURE : all aspects of national or local culture including religious events, philosophy, social science, language, theatre, and so on.
- SCIENCE : programs on natural science and technology
- VARIED : popular programs such as quiz, entertainment, private interview, comedy, satire and so on.
- POP M : program on commercial, practical and popular songs, and sale volume of discs, etc.
- ROCK M : practical modern music generally composed and played by young musicians.
- M O R M : popular music usually lasting for less than 5 minutes.
- LIGHT M : classical music, instrumental music, chorus, and light music favored by non-professionals.
- CLASSICS : orchestra including great operas, symphony, chamber music and so on.
- OTHER M : other music styles(Rhythm & Blues, Reggae, etc.)
- WEATHER : weather reports, forecast
- FINANCE : financial reports, commerce, trading
- CHILDREN : children's programs
- SOCIAL A : social affairs
- RELIGION : religious programs
- PHONE IN : program in which the public expresses its view by phone.
- TRAVEL : travel reports
- LEISURE : programs concerning recreational activities
- JAZZ : jazz music
- COUNTRY : country music
- NATIONAL : national music
- OLDIES : music from the so-called golden of popular music
- FOLK M : folk music
- DOCUMENT : documentaries

Setting the Clock

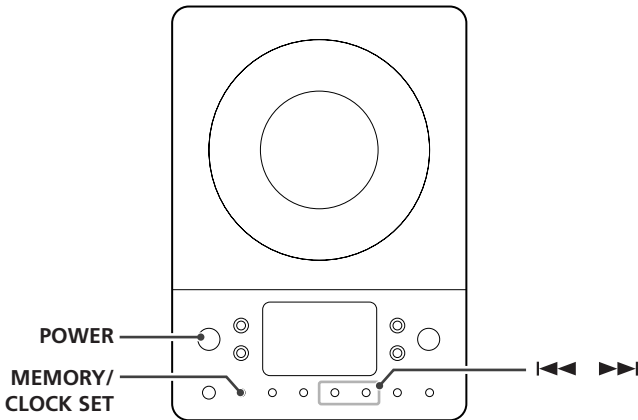

If the power switch of the subwoofer turned off, the settings kept in memory (clock, preset stations, timer setting) will be erased.

1 If the unit is on, press the POWER switch to turn it off.



2 Press and hold down the CLOCK SET button.

'12 HOUR' or '24 HOUR' blinks. If you want to change the hour mode, press the ◀◀ or ▶▶ button.



3 Press the CLOCK SET button once more.

The 'hour' value blinks.



4 Press the SKIP button (◀◀ / ▶▶) to set the current hour.

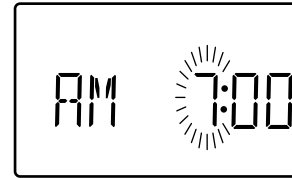

5 Press the CLOCK SET button.

The 'minute' value blinks.

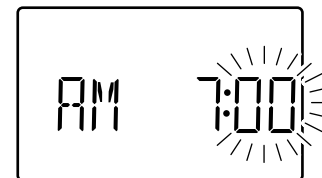

6 Press the SKIP button (◀◀ / ▶▶) to set the current minute.

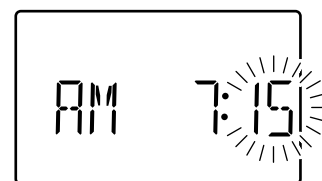

7 Press the CLOCK SET button.

The clock starts.

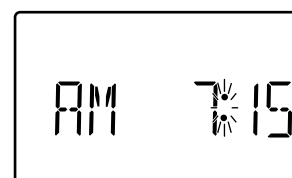

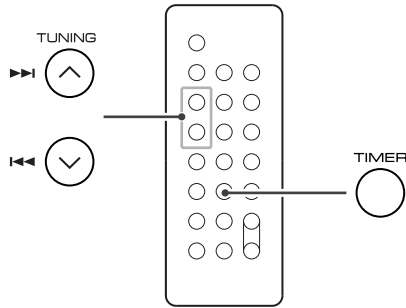

Adjust the clock before setting the timer.

If the power switch of the subwoofer turned off, the settings kept in memory (clock, preset stations, timer setting) will be erased.

1 Press and hold the TIMER button until 'TIMER' and 'ON' indicators appear on the display.

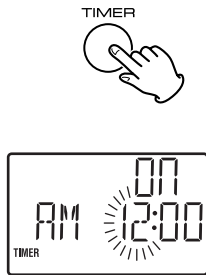

The 'hour' value starts flashing.

- When no button is pressed for 10 seconds, the timer setting mode will be cancelled.

2 Press the SKIP button (◀▶) to set the start time (hour), and then press the TIMER button.

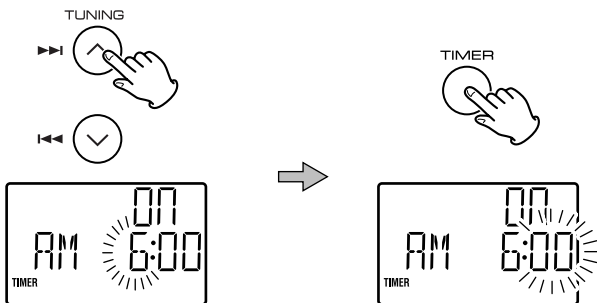

The 'minutes' value starts flashing.

3 Press the SKIP button (◀▶) to set the start time (minute), and then press the TIMER button.

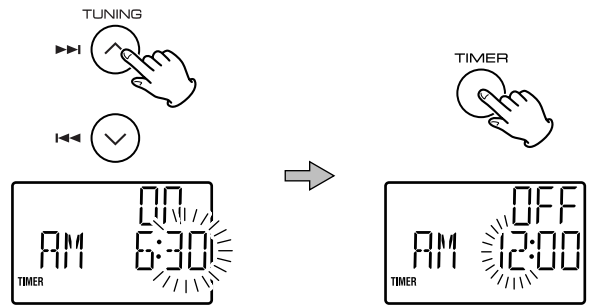

'TIMER' and 'OFF' indicators appear on the display and the 'hour' value starts flashing.

4 Press the SKIP button (◀▶) to set the stop time (hour), and then press the TIMER button.

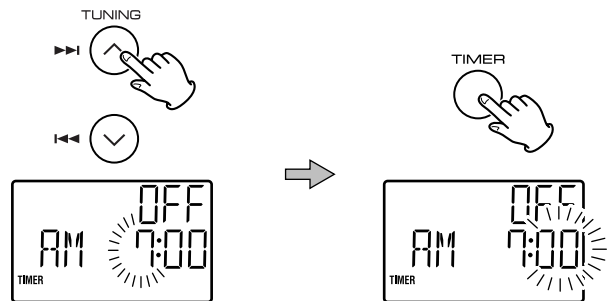

The 'minutes' value starts flashing.

5 Press the SKIP button (◀▶) to set the stop time (minute), and then press the TIMER button.

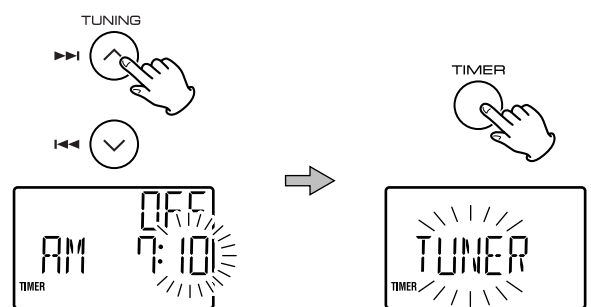

6 Press the SKIP button (◀▶) to select a source (CD or TUNER), and then press the TIMER button.

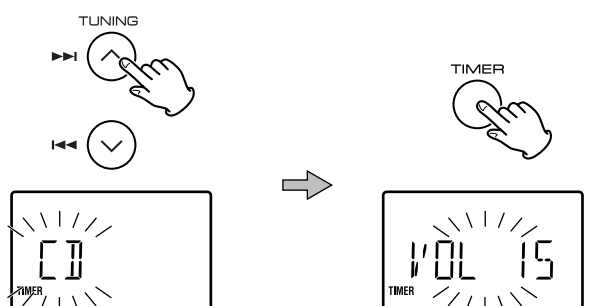

- 7** Press the SKIP button (|◀◀/▶▶|) to set the volume, and then press the TIMER button.

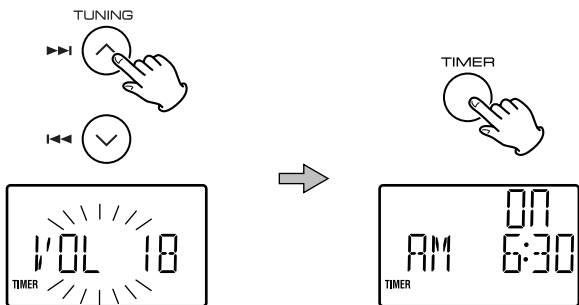

Setting the timer is now completed and the timer is turned on. Your timer setting is displayed one by one, and the TIMER indicator lights on the display.

- 8** Prepare the source.

When the source is set to 'CD', set a CD.
When the source is set to 'TUNER', tune in a station.

- 9** Press the POWER button to turn the unit off (standby).

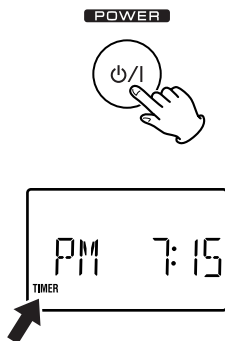

The clock and the TIMER indicator are displayed.
The unit will turn on and off at the specified time every day.

Don't forget to turn the unit off (standby), or the timer won't work.

To turn on or off the timer

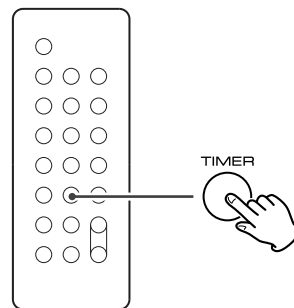

When you don't use the timer, press the TIMER button to turn it off. (The TIMER indicator disappears from the display.)
Press the TIMER button again to turn it on.

- When the timer is turned on, the timer settings are displayed one by one, and the TIMER indicator lights on the display.

If you have problems with your system, look through this chart and see if you can solve the problem yourself before calling your dealer or TEAC service center.

General

No power

- ➔ Check the connection to the AC power supply. Check and make sure the AC source is not a switched outlet and that, if it is, the switch is turned on. Make sure there is power to the AC outlet by plugging another item such as a lamp or fan into the outlet.

No sound from speakers.

- ➔ Select the source by pressing the FUNCTION button.
- ➔ Check the connection to the speakers.
- ➔ Adjust the volume.
- ➔ Pull out the headphone's plug from the PHONES jack.
- ➔ If the VOLUME level indicator is blinking, press the MUTING button.

The sound is noisy.

- ➔ The unit is too close to a TV or similar appliances. Install the unit apart from them, or turn them off.

Remote control doesn't work.

- ➔ Press the POWER switch to turn the unit on.
- ➔ When the battery has run out, put in a new one.
- ➔ Use remote control unit within the range (5 m) and point at the front panel.
- ➔ Clear obstacles between the remote control unit and the main unit.
- ➔ If a strong light is near the unit, turn it off.

CD Player

Cannot play.

- ➔ Load a disc with the playback side facing away.
- ➔ If the disc is dirty, clean the surface of the disc.
- ➔ A blank disc has been loaded. Load a prerecorded disc.
- ➔ Depending on the disc, etc. it may not be possible to play back CD-R/RW discs. Try again with another disc.
- ➔ You cannot play back unfinalized CD-R/RW discs. Finalize such a disc in a CD recorder and try again.

Sound skips.

- ➔ Place the unit on a stable place to avoid vibration and shock.
- ➔ If the disc is dirty, clean the surface of the disc.
- ➔ Don't use scratched, damaged or warped discs.

Tuner

Cannot listen to any station, or signal is too weak.

- ➔ Tune in the station properly.
- ➔ Rotate the FM or AM antenna for the best reception position.

Though the broadcast is stereo, it sounds monaural.

- ➔ Press the STEREO/MONO button.

If normal operation cannot be recovered, unplug the power cord from the outlet and plug it again.

If the power switch of the subwoofer turned off, the settings kept in memory (clock, preset stations, timer setting) will be erased.

Beware of condensation

When the unit (or a disc) is moved from a cold to a warm place, or used after a sudden temperature change, there is a danger of condensation; vapor in the air could condense on the internal mechanism, making correct operation erratic or impossible. To prevent this, or if this occurs, leave the unit for one or two hours with the power turned on. The unit will stabilize at the temperature of its surroundings.

Maintenance

If the surface of the unit gets dirty, wipe with a soft cloth or use diluted mild liquid soap. Never spray liquid directly on this unit. Apply your cleaner to your cleaning cloth and wipe gently. Be sure to remove any excess completely. Do not use thinner, benzene or alcohol as they may damage the surface of the unit. Allow the surface of the unit to dry completely before using.

Specifications

AMPLIFIER section

Output Power (L+R)	5 W + 5 W
Output Power (Subwoofer)	15 W
Input Sensitivity	300 mV
Frequency Response	50 to 20,000 Hz

TUNER Section (FM)

Frequency Range	87.50 to 108.00 MHz
Sensitivity (S/N30dB)	20 dB μ V

TUNER Section (AM)

Frequency Range	522 to 1620 kHz
Sensitivity (S/N20dB)	54 dB μ V/m

CD PLAYER Section

Frequency Response	20 to 20,000 Hz (\pm 1 dB)
Signal-to-Noise Ratio	55 dB
Wow and Flutter	Unmeasurable

SPEAKER

Type	Full range flat type
Impedance	4 ohms

SUBWOOFER

Impedance	8 ohms
---------------------	--------

GENERAL

Power Requirements	230 V AC, 50 Hz
Power Consumption	80 W (standby: less than 1.4 W)

Dimension (W x H x D)

Main Unit	160 x 226 x 86 mm
L & R Speakers	140 x 226 x 61 mm
Subwoofer	160 x 234 x 330 mm

Weight

Main Unit	1.15 kg
L & R Speakers	0.6 kg each
Subwoofer	5.4 kg

Standard Accessories

Remote Control Unit (RC-970) x 1
Subwoofer Cable x 1
Speaker Cable x 2
FM Antenna x 1
AM Antenna x 1
Battery for Remote Control x 1
Wall Mount Adaptor x 3
Wall Mount Screw x 10
Tapered Plastic Wall Anchor x 10
Template for Wall Mounting x 1
Owner's Manual x 1
Warranty Card x 1

- Design and specifications are subject to change without notice.
- Weight and dimensions are approximate.
- Illustrations may differ slightly from production models.

TEAC

TEAC CORPORATION	3-7-3, Nakacho, Musashino-shi, Tokyo 180-8550, Japan Phone: (0422) 52-5081
TEAC AMERICA, INC.	7733 Telegraph Road, Montebello, California 90640 Phone: (323) 726-0303
TEAC CANADA LTD.	5939 Wallace Street, Mississauga, Ontario L4Z 1Z8, Canada Phone: (905) 890-8008
TEAC MEXICO, S.A. De C.V	Campesinos N°184, Colonia Granjas Esmeralda, Delegacion Iztapalapa, CP 09810, México DF Phone: (525) 581-5500
TEAC UK LIMITED	5 Marlin House, Croxley Business Park, Watford, Hertfordshire, WD18 8TE, U.K. Phone: 01923-819699
TEAC EUROPE GmbH	Bahnstrasse 12, 65205 Wiesbaden-Erbenheim, Germany Phone: 0611-71580
TEAC ITALIANA S.p.A.	Via C. Cantù 11, 20092 Cinisello Balsamo, Milano, Italy Phone: 02-66010500
TEAC AUSTRALIA PTY., LTD. A.B.N. 80 005 408 462	280 William Street, Melbourne VIC 3000, Australia Phone: (03) 9672-2400

This appliance has a serial number located on the rear panel. Please record the model number and serial number and retain them for your records.

Model number _____ Serial number _____

0405-MA-0972A

Free Manuals Download Website

<http://myh66.com>

<http://usermanuals.us>

<http://www.somanuals.com>

<http://www.4manuals.cc>

<http://www.manual-lib.com>

<http://www.404manual.com>

<http://www.luxmanual.com>

<http://aubethermostatmanual.com>

Golf course search by state

<http://golfingnear.com>

Email search by domain

<http://emailbydomain.com>

Auto manuals search

<http://auto.somanuals.com>

TV manuals search

<http://tv.somanuals.com>