

# 1. IMPORTANT SAFETY INSTRUCTIONS

Electrical energy can perform many useful functions, but it can also cause personal injuries and property damage if improperly handled. This product has been engineered and manufactured with the highest priority on safety. But **IMPROPER USE CAN RESULT IN POTENTIAL ELECTRICAL SHOCK OR FIRE HAZARD**. In order to prevent potential danger, please observe the following instructions when installing, operating and cleaning the product. To ensure your safety and prolong the service life of your LCD TV product, please read the following precautions carefully before using the product.

**1. Read instructions**—All operating instructions must be read and understood before the product is operated.

**2. Retain instructions**—These safety and operating instructions must be kept in a safe place for future reference.

**3. Observe warnings**—All warnings on the product and in the instructions must be observed closely.

**4. Follow instructions**—All operating instructions must be followed.

**5. Water and moisture**—Do not use this product near water - for example, near a bathtub, washbowl, kitchen sink, or laundry tub, in a wet basement, or near a swimming pool, and the like.

Do not use immediately after moving from a low temperature to high temperature environment, as this causes condensation, which may result in fire, electric shock, or other hazards.

Moisture in rooms where the set is installed should not exceed 85% humidity

Leave the condensation to evaporate before turning the TV on again.



**6. Cleaning**— Unplug this product from the wall outlet before cleaning. Do not use liquid cleaners or aerosol cleaners. Use a damp cloth for cleaning.

Only use a cotton cloth to clean the screen. Clean the rest of the set with a soft cloth and neutral detergent. Regularly dust the vents at the back and sides. Using solvents, abrasive or alcohol based products risk damaging the TV.

**Caution** : the screen of your LCD TV may be damaged if it is cleaned with strong detergents, alcohol or abrasive products.

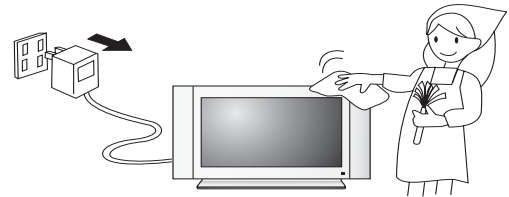

**7. Ventilation**—The vents and other openings in the cabinet are designed for ventilation. Do not cover or block these vents and openings since insufficient ventilation can cause overheating and/or shorten the life of the product. Do not place the product on a bed, sofa, rug or other similar surface, since they can block ventilation openings. This product is not designed for built-in installation; do not place the product in an enclosed place such as a bookcase or rack, unless proper ventilation is provided or the manufacturer's instructions are followed.

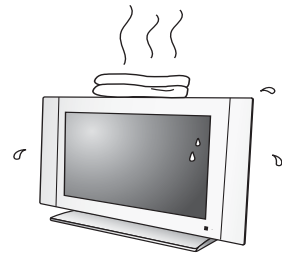

**8. Heat sources**—Keep the product away from heat sources such as radiators, heaters, stoves and other heat-generating products (including amplifiers).

The TV components are sensitive to heat. The maximum ambient temperature should not exceed 35° celsius.

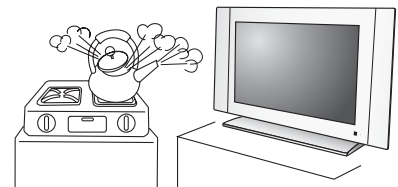

**9. Power cord protection**—The power cords must be routed properly to prevent people from stepping on them or objects from resting on them. Check the cords at the plugs and product.

Power-supply cords should be routed so that they are not likely to be walked on or snagged by items placed upon or against them. Pay particular attention to cords at doors, plugs, receptacles, and the point where they exit from the product.



**10. Attachments**—Do not use attachments not recommended by the manufacturer. Use of improper attachments can result in accidents.

**11. Accessories**—When the product is used on a trolley, care should be taken to avoid quick stops, excessive force, and uneven surfaces that may cause the product and trolley to overturn, damaging equipment or causing possible injury to the operator. Do not place this product on an unstable trolley, stand, pedestal, bracket, or table. The product may fall, causing serious injury to a child or adult and serious damage to the product. The product should be mounted according to the manufacturer's instructions, and use only with a trolley, stand, pedestal, bracket, or table recommended by the manufacturer.

**12. Servicing**—Do not attempt to service the product yourself. Removing covers can expose you to high voltage and other dangerous conditions. Request a qualified service person to perform servicing.

**13. Replacement parts**—In case the product needs replacement parts, make sure that the service person uses replacement parts specified by the manufacturer, or those with the same characteristics and performance as the original parts. Use of unauthorized parts can result in fire, electric shock and/or other danger.

**14. Power source**—This product is intended to be supplied by a listed power supply, output rated: ~100 - 240 V, 50 - 60Hz, 1.8A maximum, indicated on the marking label. If you are not sure of the type of power supply to your home, consult your product dealer or local power company. For added protection for this product during a lightning storm, or when it is left unattended and unused for long periods of time, unplug it from the wall outlet and disconnect the cable system. This will prevent damage to the product due to lightning and power line surges. When the unit has to be used with another power supply voltage, the power cable must be changed. Consult your product dealer. The socket outlet should be installed near the equipment and easily accessible. The power cord attached conforms to the following power supply voltage. Use only the power cord designated by our dealer to ensure safety and EMC. When connecting other products such as VCRs and personal computers, you should turn off the power of the unit for protection against electric shock.

**15. Overloading**—Do not overload wall outlets, extension cords, or convenience receptacles on other equipment as this can result in a risk of fire or electric shock.

**16. Entering of objects and liquids**—Never insert an object into the product through vents or openings. High voltage flows in the product, and inserting an object can cause electric shock and/or short internal parts. For the same reason, do not spill water or liquid on the product.

**17. Damage requiring service**—If any of the following conditions occurs, unplug the power cord from the AC outlet, and request a qualified service person to perform repairs.

- a. When the power cord or plug is damaged.
- b. When a liquid is spilled on the product or when objects have fallen into the product.
- c. When the product has been exposed to rain or water.
- d. When the product does not operate properly as described in the operating instructions.

Do not touch the controls other than those described in the operating instructions. Improper adjustment of controls not described in the instructions can cause damage, which often requires extensive adjustment work by a qualified technician.

- e. If the product has been dropped or the cabinet has been damaged in any way.
- f. When the product displays an abnormal condition or exhibits a distinct change in performance. Any noticeable abnormality in the product indicates that the product needs servicing.

**18. Safety checks**—Upon completion of service or repair work, request the service technician to perform safety checks to ensure that the product is in proper operating condition.

**19. Wall or ceiling mounting**—When mounting the product on a wall or ceiling, be sure to install the product according to the method recommended by the manufacturer. This is a safety feature.

**20. Stand**—Do not place the product on an unstable trolley, stand, tripod or table. Placing the product on an unstable base can cause the product to fall, resulting in serious personal injuries as well as damage to the product. Use only a trolley, stand, tripod, and bracket or table recommended by the manufacturer or sold with the product. When mounting the product on a wall, be sure to follow the manufacturer's instructions.

Use only the mounting hardware recommended by the manufacturer.

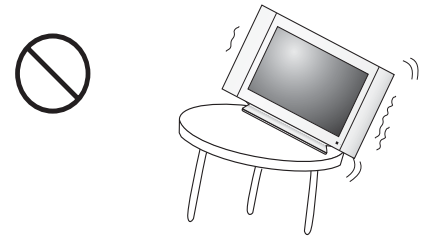

**21. Careful move**— When relocating the product placed on a trolley, it must be moved with the utmost care. Sudden stops, excessive force and uneven floor surfaces can cause the product to fall from the trolley.



**22. Panel protection**—The LCD panel used in this product is made of glass.

Therefore, it can break when the product is dropped or impacted upon by other objects. Be careful not to be injured by broken glass pieces in case the LCD panel breaks.

*On some models, the screen is protected by a glass shield. Under certain conditions (changes of temperature and humidity) moisture may form between the glass and the screen. If this relatively rare condition arises, it is only necessary to switch on the LCD TV, to make it disappear progressively.*

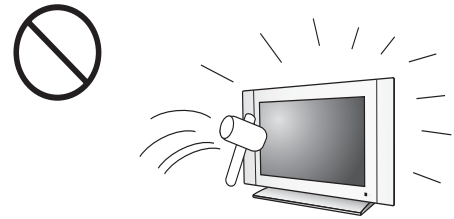

**23. Pixel defect**—The LCD panel is a very high technology product, giving you finely detailed pictures. Occasionally, a few non-active pixels may appear on the screen as a fixed point of blue, green or red. Please note that this does not affect the performance of your product.

For added protection for this television equipment during a lightning storm, or when it is left unattended and unused for long periods of time, unplug it from the wall outlet and disconnect the antenna. This will prevent damage to the equipment due to lightning and power-line surges.

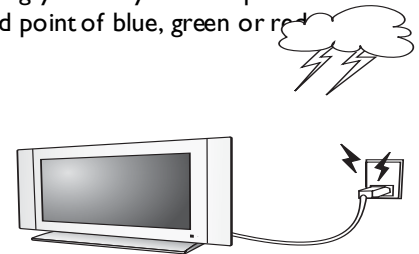



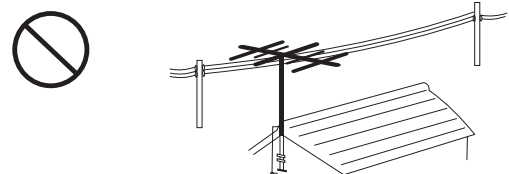

An outside antenna system should not be located in the vicinity of overhead power lines or other electric light or power circuits, or where it can collide with such power lines or circuits. When installing an outside antenna system, extreme care should be taken to keep from touching such power lines or circuits, as contact with them might be fatal.



## I IMPORTANT INFORMATION

**WARNING: TO REDUCE THE RISK OF FIRE OR ELECTRIC SHOCK, DO NOT EXPOSE THIS PRODUCT TO RAIN OR MOISTURE.**

 <p><b>CAUTION</b> RISK OF ELECTRIC SHOCK DO NOT OPEN</p> 	 <p>The exclamation point within a triangle is intended to alert the user to the presence of important operating and maintenance (servicing) instructions in the literature accompanying the product.</p>  <p>The lightning flash with arrowhead symbol, within an equilateral triangle, is intended to alert the user to the presence of uninsulated "dangerous voltage" within the product's enclosure that may be of sufficient magnitude to constitute a risk of electric shock to persons.</p>
<p>CAUTION: TO REDUCE THE RISK OF ELECTRIC SHOCK, DO NOT REMOVE COVER (OR BACK). NO USER-SERVICEABLE PARTS INSIDE. REFER SERVICING TO QUALIFIED SERVICE PERSONNEL.</p>	

**CAUTION: TO PREVENT ELECTRIC SHOCK, MATCH WIDE BLADE OF PLUG TO WIDE SLOT, FULLY INSERT.**

## II SAFETY TIPS

**Please read and follow the safety tips listed below to ensure the equipment is free from damage, and to ensure that no injury will occur as a result of improper use.**

- Do not insert any object, especially metal or liquids, into the TV.
- Do not place any objects containing water or any other liquid on top of the TV.
- Do not place the unit in direct sunlight, near heaters or in extremely dusty or humid locations.
- Do not install this system outdoors or otherwise expose it to the elements.
- Do not place heavy objects on top of the TV.
- If the power cord is damaged or frayed in any way, electrical shock and/or fire may result.
- Please do not place objects on the power cord, and keep the cord away from heat-emitting devices. Should the power cord become damaged in any way, please contact your dealer for a replacement cord.
- Do not remove the cover of the TV for any reason. If any problems arise with the unit, please contact your dealer for service. Removing the covers will void the warranty.

## III WARNING

### Before Setting Up

**Do not place the TV on sloped or unstable surfaces.**

- The TV may fall or tip over.

**Do not place any objects on top of the TV.**

- If water spills onto the LCD TV or foreign objects get inside it, a short-circuit may occur which could result in fire or electric shock. If any foreign objects get inside the LCD TV, please consult an Authorized Dealer.

**Do not cover the ventilation holes.**

Doing so may cause the LCD TV to overheat, which can cause fire or damage to the set.

### AC Power Supply Cord

**The LCD TV is designed to operate on 100~240 V AC, 50/60 Hz.**

**Securely insert the power cord plug as far as it will go.**

- If the plug is not fully inserted; heat may be generated which could cause fire. If the plug is damaged or the wall socket plate is loose, they should not be used.

**Do not handle the power cord plug with wet hands.**

- Doing so may cause electric shocks.

**Do not do anything that might damage the power cable. When disconnecting the power cable, hold the plug, not the cable.**

- Do not make any modifications, place heavy objects on, place near hot objects, heat, bend, twist or forcefully pull the power cable. Doing so may cause damage to the power cable, which can cause fire or electric shock. If damage to the cable is suspected, have it repaired at an Authorized Service Center

**If the LCD TV is not in use for a long period of time, unplug the power cord from the wall outlet.**

### **If problems occur during use**

**If a problem occurs (such as no picture or no sound), or if smoke or an abnormal odor is detected from the LCD TV, unplug the power cord immediately.**

- Continuous use of the Display under these conditions might cause fire or permanent damage to the unit. Have the Display evaluated at an Authorized Service Center. Services to the Display by any unauthorized personnel are strongly discouraged due to its dangerous high voltage nature.

**If water or foreign objects get inside the TV, if the TV is dropped, or if the cabinet becomes damaged, disconnect the power cord plug immediately.**

- A short-circuit may occur, which could cause fire. Contact an Authorized Service Center for any repairs that need to be made.

## **IV CAUTION**

### **When using the LCD TV**

To turn off the main power, be sure to remove the plug from power outlet. The power outlet socket should be installed as near to the equipment as possible, and should be easily accessible.

**Be sure to disconnect all cables before moving the LCD TV.**

- Moving the Display with its cables attached might damage the cables, which, in turn, can cause fire or electric shock.

•

**Disconnect the power plug from the wall outlet as a safety precaution before carrying out any cleaning.**

Electric shocks can result if this is not done.

**Clean the power cable regularly to prevent it from becoming dusty.**

- Built-up dust on the power cord plug can increase humidity, which might damage the insulation and cause fire.

Unplug the cord from the wall outlet and clean it with a dry cloth.

- Do not insert any objects or liquids into the unit.
- Do not expose the unit to water or moisture, or otherwise to the elements
- Do not open the unit for any reason. Doing so will void the warranty!
- Unplug the unit if it will not be used for an extended period of time
- Avoid placing the unit near sources of heat
- Avoid placing the unit in direct sunlight
- In any event, if any problems arise, contact your dealer immediately!



## 2. INTRODUCTION

**Congratulations** on your purchase of a **THOMSON LCD TV**. Your LCD TV will provide you with many years of enjoyment no other LCD TV can match. It is compatible with today's current NTSC, PAL and SECAM systems, as well as tomorrow's DTV standards. This TV is extremely easy to use and features high performance picture quality. The LCD TV is extremely versatile; it can be mounted on a wall or table stand, and it can be used in any ambient light environment.

This manual will explain how to use your LCD TV, as well as its features, benefits and other important information. Please be sure to read this manual before installing or operating your LCD TV, especially the safety precautions!

### I SUPPLIED ACCESSORIES

Make sure the following accessories are provided with the product.

User Manual(IB) (x1)

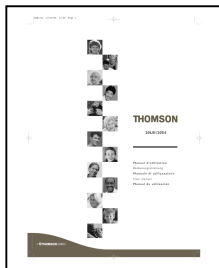

Remote Control (x1)



Power Cord for European Type (x1)

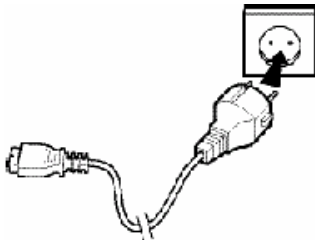

Power Cord for UK Type (x1)

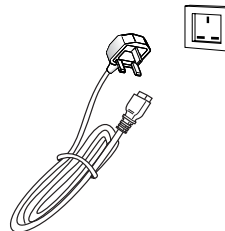

RF Coaxial Cable

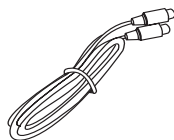

D-Sub to Component Cable (Depending on model)

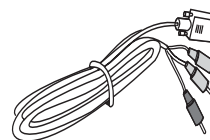

Size AAA Dry Battery (x2)



Please respect the environment and prevailing regulations. Before you dispose of batteries or accumulators, ask your dealer whether they are subject to special recycling and if he accepts to take them back.

**Note: The AC Power cord type is different in different territories**

## II PREPARATION

### Using the Remote Control

Use the remote control by pointing it towards the remote sensor window of the set. Objects between the remote control and sensor window may prevent proper operation

#### Cautions regarding use of remote control

- Do not expose the remote control to shock. In addition, do not expose the remote control to liquids, and do not place in an area with high humidity.
- Do not install or place the remote control under direct sunlight. The heat may cause deformation of the unit.
- The remote control may not work properly if the remote sensor window of the main unit is under direct sunlight or strong lighting. In such a case, change the angle of the lighting or LCD TV set, or operate the remote control closer to the remote sensor window.

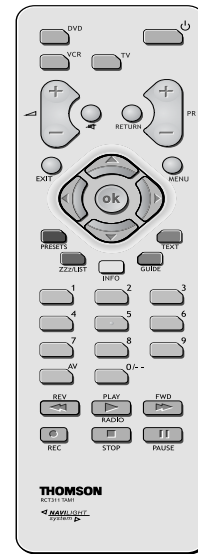

#### Batteries for the Remote Control

If the remote control fails to operate the LCD TV functions, replace the batteries in the remote control.

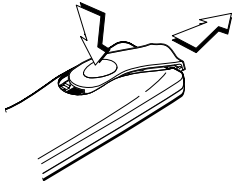
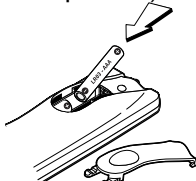
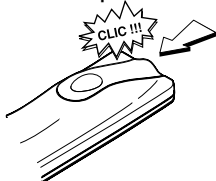
<p>Open the battery cover.</p>  <p>(Slide the cover while pressing down.)</p>	<p>Insert batteries (size-AAA batteries, supplied with product).</p>  <p>(Place the batteries with their terminals corresponding to the (+) and (-) indications in the battery compartment.</p>	<p>Replace the cover and slide in reverse until the lock snaps.</p>  <p>CLIC!!!</p>
--	--	--

#### Precaution on battery use

Improper use of batteries can result in a leakage of chemicals and/or explosion. Be sure to follow the instructions below.

- Place batteries with their terminals corresponding to the (+) and (-) indications.
- Only use the battery types specified.
- Do not use rechargeable batteries.
- Different types of batteries have different characteristics. Do not mix batteries of different types.
- Do not mix old and new batteries. Mixing old and new batteries can shorten the life of new batteries and/or cause old batteries to leak chemicals.
- Do not expose batteries to excessive heat, throw them in a fire, recharge them or try to open them, as this could cause them to leak or explode.
- Remove the batteries from the remote control if you are not using it for a long period of time (several weeks).
- Remove batteries as soon as they are non-operable. Chemicals that leak from batteries can cause a rash. If chemical leakage is found, wipe with a cloth.
- The batteries supplied with the product may have a shorter life expectancy due to storage conditions.
- If the remote control is not used for an extended period of time, remove the batteries from the remote control.

## 3. GETTING STARTED

### Switching on

Follow the instructions on this page on how to switch on your TV set and the remote control before going on to following pages describing how to use the remote control and the channel set-up procedure.

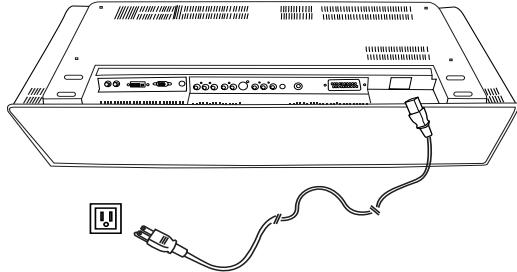

1. Connect the female plug to AC power input of the set.
2. Connect the male plug to the wall outlet as illustrated.

220-240 V~50 Hz

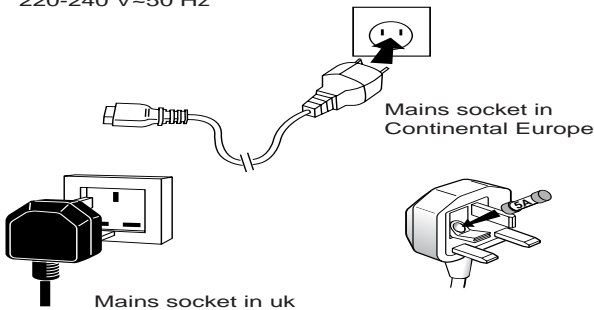

*Equipment for the UK is supplied with a mains cable fitted with a moulded plug.*

*This plug contains safety components and must not be replaced by one sold by general retailers. It is fitted with a fuse that protects your television.*

*If your set has stopped working, the fuse may have blown. If it has, replace it with an identical ASTA or BSI certified (BS 1362) 5-amp fuse.*

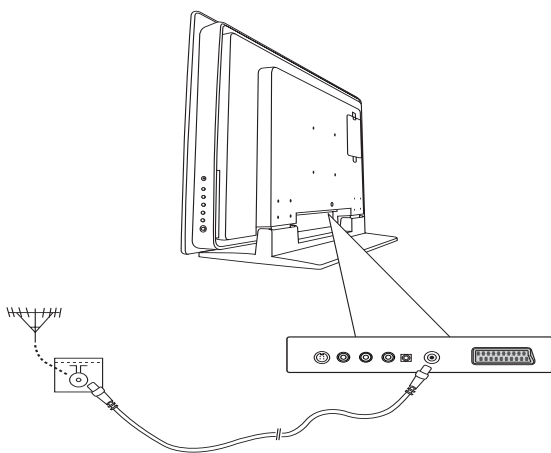

3. Connect the outside aerial or cable network to the socket at the back of the TV set.

*The aerial socket (75 Ohms - VHF / UHF / cable) can be used for connecting an external aerial or other equipment fitted with a modulator (video recorder, satellite receiver, etc.).*

*We recommend that you do not connect other equipment (video recorder, satellite receiver, etc.) to your TV set to begin with, so as not to complicate the set-up procedure with the additional steps involved. Connect them when you have finished setting up the channels by referring to page 21 of this manual.*

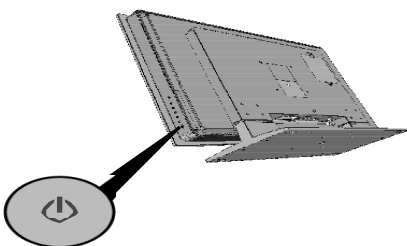

4. Switch the TV on by pressing the on/off button on the right side.







*You will find a description of how to use the remote control on page 9. Then go to page 11 for information on the initial set-up, or to page 13 for information on manual set-up (if the channels have already been set up on your TV).*

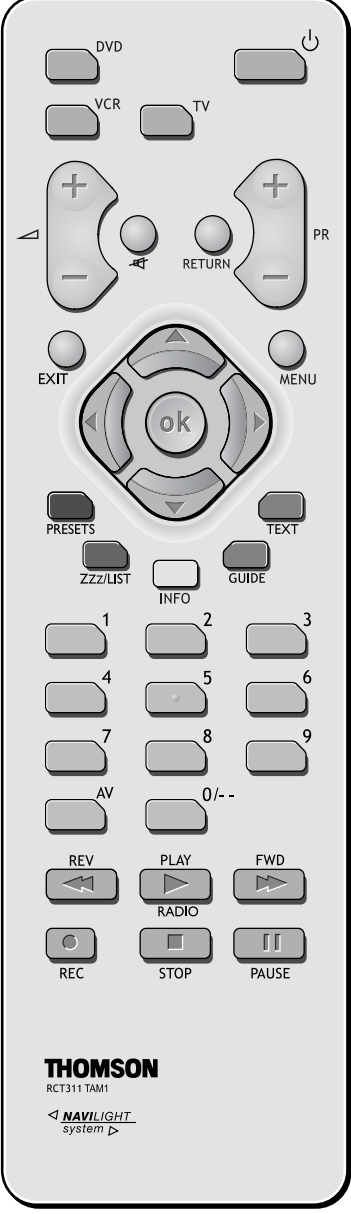

# Getting started





## Remote control TV functions

Most of your television's functions are available via the menus that appear on the screen. The remote control supplied with your set can be used to navigate through the menus and to configure all the general settings. This page contains the description of the remote control.

	 Standby / quit standby.
	<b>DVD</b> To access DVD mode.
<b>VCR</b> To access VCR mode.	
<b>TV</b> To access TV mode. Press this button to control the television.	
<b>Light</b> To provide information: <ul style="list-style-type: none"><li>- it lights up when you press a button</li><li>- it indicates the status when the remote control is being programmed (see page 10)</li><li>- if the batteries are run down, it flashes when you press a button.</li></ul>	
 To control the volume. <i>This function is also available in VCR and DVD modes.</i>	
 To switch the sound off and back on again.	
<b>RETURN</b> To return to the previous menu or the previous program	
<b>PR+/PR-</b> To change channels	
<b>EXIT</b> To exit a menu	
<b>MENU</b> To access the <b>OVERVIEW</b> menu	
 To select menu options	
 To set functions, change values, enable and disable functions, and to select the picture format (In TV, AV and PC mode)	
<b>OK</b> To confirm a selection.	
<b>Coloured buttons:</b>	
<b>PRESETS</b> (red button) picture preset settings	
<b>Zzz/LIST</b> (green button) sleep timer setting	
<b>INFO</b> (yellow button) status information	
<b>GUIDE</b> (blue button) <i>disabled in TV mode</i>	
<b>TEXT</b> (purple button) Teletext <i>The coloured buttons can also be used for operating Teletext.</i>	
<b>0-9</b> To select a channel by its number. <i>Single digit entry is the default so in the case of channel numbers with two digits, press 0 to display “-”, then enter the channel number.</i>	
<b>AV</b> To select an appliance connected to an AV socket.	

## Using the remote control for other equipment



The remote control supplied with your set can be used for other equipment, such as video recorders, PC or DVD players. This page provides information concerning the remote control's use with these types of equipment.

	<b>VCR</b>	<b>DVD</b>
<b>VCR</b> <b>DVD</b> 	Press the <b>VCR</b> button On/Standby	Press the <b>DVD</b> button On/Standby
<b>MENU</b>     <b>OK</b>	To display the main menu Vertical scrolling in menus Horizontal scrolling in menus To confirm an action	To display the main menu Vertical scrolling in menus Horizontal scrolling in menus To confirm an action
<b>EXIT</b> <b>0-9</b> <b>PR+/PR-</b> <b>AV</b> <b>REV</b> <b>PLAY</b> <b>FWD</b> <b>STOP</b> <b>PAUSE</b> <b>REC</b>	To close a menu To directly access channels or enter numeric values To change channels To select AV input Rewind Play Fast forward Stop Pause picture Record	To close a menu To enter numeric values or select options in menus  To select Rewind Play Fast forward Stop Pause picture

### Programming the remote control

#### Automatic code search

This method can be used to automatically find the most appropriate code protocol for your appliance.

1. Switch on the appliance you wish to use the remote control with.
2. Press the relevant button for this appliance on the remote control, and while holding this button down, press the  standby button until the remote control light comes on. Release the two buttons.
3. Point the remote control at the appliance and press **PLAY**. Wait until the light stops flashing. If the appliance has not gone into standby mode after five seconds, press the **PLAY** button again to continue the search for the next set of codes. Repeat this operation until the appliance goes into standby mode. There are 20 sets of codes.
4. When the appliance goes into standby mode, press the standby  button on the right up side to switch it on again. Then press the **REV** button to put it back in standby mode, and if necessary, keep pressing until the appliance goes into standby.
5. Press the **STOP** button and hold it down until the remote control light goes off.

**Note:** you can cancel the programming operation at any time by pressing the **EXIT** button.

#### Manual programming

This method involves carrying out a manual search for the code to be used for controlling your other appliances.

1. Switch on the appliance you wish to use the remote control with.
2. Press the relevant button for this appliance on the remote control, and while holding this button down, enter one of the codes relevant to your make of appliance (there is a list of codes at the end of this manual). If the remote control light flashes you have entered the wrong code or it is not possible to program the remote control.
3. Point the remote control at the appliance and press the relevant button (**VCR** or **DVD**). Press the  standby button. If the appliance does not go into standby mode, try another code.

Depending on the year of manufacture and the type of appliance, some functions may not be available.

Certain codes may cover more functions than others. Test the functions you can control and, if appropriate, try other codes.

**Note** here the code(s) which work best.

VCR	<input type="checkbox"/>	<input type="checkbox"/>	<input type="checkbox"/>	<input type="checkbox"/>
DVD	<input type="checkbox"/>	<input type="checkbox"/>	<input type="checkbox"/>	<input type="checkbox"/>

When you **change the remote control's batteries**, remember to **reprogram** it.

## 4. CHANNELS SET-UP

**Note** :If you use the device as LCD Monitor function not a TV, you may skip the chapter.

### Initial set-up

	<p><b>✖ AUTOMATIC INSTALLATION</b></p> <p>Return</p> <p>Standard                      EURO...</p> <p><b>Start</b>                              Running...</p> <p>Frequency                      150.75MHz</p> <p>Programmes found              02</p>	
		<p>Initial set-up involves selecting all the settings required to be able to search for and store all the channels you can receive.</p> <p>Make sure that the television is switched on and follow all the steps in turn specified on this page.</p>

**1. When you first switch the TV set on**, the **language** selection menu appears.

Choose which language you want the menus to appear by using the **▲ / ▼** buttons.

When you select a language, it is applied to the menus immediately.

**2.** Confirm with **OK**. **Countries** menu will come out and a list of countries will appear.

**3.** Select the relevant country by using the **▲ / ▼** buttons.

*This is the country you are in, or the county whose channels you want to receive if living near its borders.*

**4.** Confirm with **OK**. The **AUTOMATIC INSTALLATION** menu will display.

**5.** The **Standard** option is selected.

Select a suitable standard using the **◀ / ▶** buttons.

**Note:** the following standards are available to choose from: **UK** for the UK and Ireland, **FR** for France and Luxembourg, **DK** for Eastern Europe, the Middle East and Asia, **EURO** for Western Europe, Australia and New Zealand.

**6.** Then select the **Start** option by using the **▼** button and press **OK** to start the search.

During this time the message **"Running"** appears next to the **Start** option and the **Frequency** and **PR found**(Programme found) options appear, informing you of the process of installation procedure.

If you press the **EXIT** button before the end of channel searching, the channels already found are stored.

Once the search has ended the **ORGANISER** menu appears (see following page).

**Note** : You may subsequently return to **AUTOMATIC INSTALLATION** menu by selecting the **Automatic installation** line in the **INSTALLATION** menu.



## Organiser

 <b>ORGANISER</b>		
Return		
Select programme	01	
Swap with programme	--	
Change pr. name	BBC1	
Delete programme	01	

By using this menu you can change the channels order arranged during automatic set-up, name and rename channels, delete duplicate channels or those with poor reception quality.

Follow the help messages at the bottom of the screen and refer to a TV programme guide to help identify the channels.

### Arranging channels in order

The **Select programme** line is selected.

Display the channel number to be changed using the **PR+/PR-** buttons or the 0-9 keys.

Select the option **Swap with programme**. Enter the new programme number using the 0-9 keys.

Press **OK** to confirm. When you successfully finish the swap, the bottom help line will show

“ **The programmes have been swapped**” message. Follow the same procedure for the other channels.

### Deleting channels

The **Select programme** line is selected.

Display the channel number to be deleted using the **PR+/PR-** buttons or the 0-9 keys.

Select the **Delete programme** option and press the **OK** button to delete the channel.

Once this channel has been deleted the bottom help line will show “ **The programme has been deleted**” message.

**Note** : you can use **AUTOMATIC UPDATE** menu (from **Installation** menu) to restore the deleted programme

### Naming or renaming channels

The **Select programme** line is selected.

Display the number of the channel whose name you want to change using the **PR+/PR-** buttons.

The relevant channel appears. Select the **Change pr. name** option and press the **➤** button to place the cursor on the first character.

Using the **▲ / ▼** buttons, select a character from the list, which includes letters from the alphabet, numbers between 0 and 9, the characters +,., and space. Go on to the next character or back to the previous character using the **◀ / ▶** buttons and start the procedure again.

Press **OK** to confirm. Names can have a maximum of six characters.

Press **EXIT** to close the menu.

**Note** : You may subsequently return to **ORGANISER** menu by selecting the **Organiser** line in the **INSTALLATION** menu.

## Manual channel set-up

Follow the procedure given on this page if you find that some channels have not been stored during the initial set-up. This can happen if you are setting up cable network channels. Setting up channels manually requires every setting for a particular channel to be entered, one at a time.

✕ MANUAL INSTALLATION		Display the <b>OVERVIEW</b> menu by pressing the <b>MENU</b> button.
Return		Select the <b>Installation</b> option and press <b>OK</b> to confirm.
Standard	EURO...	
Frequency	150.75MHz	Select the relevant country and press <b>OK</b> .
Programme name	BBC2	
Fine-tuning	----- -----	Select the <b>Manual Installation</b> option from the <b>INSTALLATION</b> menu and press <b>OK</b> to confirm.
Store on programme	02	
Decoder	<input type="checkbox"/>	
Teletext char. set	1...	

1. Select the **Standard** option and then the relevant standard for your country using the < / > buttons.

**Note:** the following standards are available to choose from: **UK** for the UK and Ireland, **FR** for France and Luxembourg, **DK** for Eastern Europe, the Middle East and Asia, **EURO** for Western Europe, Australia and New Zealand.

2. Select the **Frequency** option. Use the < or > button to start the search in descending or ascending order. When a channel is found, pictures appear.

**Note :** If the channel name is found it is displayed next to **Programme name** option.

3. If the picture is not clear you can adjust the setting. You do this by selecting the **Fine tuning** option and adjusting it with the < / > buttons.

4. If the channel is encrypted and you want to connect a decoder, select the **Decoder** option and check the box by pressing the **OK** button.

5. Then select the **Teletext char. set** option and choose the character set that will be used for Teletext on this channel using the < / > buttons. The following character sets are available:

- 1 : Western Europe
- 2 : Eastern Europe
- 3 : Turkish and Greek
- 4 : Russian and Bulgarian
- 5 : Arabic
- 6 : Farsi

The character set selected determines how characters are displayed on Teletext screens.

6. Select the **Store on programme** option to assign a number to the channel. Enter the number using the numeric buttons. Press the **OK** button to confirm.

**Important:** As soon as you change a setting in the **MANUAL INSTALLATION** menu, the channel number starts flashing under the **Store on programme** option. To confirm your change you must select the **Store on programme** option and press **OK**. If you do not confirm the change, it will be cancelled when you change channel or put the television into standby mode.

Repeat this procedure (2 to 6) to find other channels.

### Automatic update:

**Auto update** allows you to set up channels just launched or any channels that are missing or wrongly set up.

You can access **Automatic update** menu by selecting the line inside the **INSTALLATION** menu.

**Return:** return to the **INSTALLATION** menu.

**Standard:** Select the relevant standard for your country using the < / > buttons.

**Note:** the following standards are available to choose from: **UK** for the UK and Ireland, **FR** for France and Luxembourg, **DK** for Eastern Europe, the Middle East and Asia, **EURO** for Western Europe, Australia and New Zealand.

**Start:** Press **OK** to start the auto update function

The Frequency is incrementing during the progress of the searching. "New pr. found" is incremented each time when a PR, which is not already installed, is found. When the highest frequency is reached, the auto update function will stop. Or if you press **EXIT** button, you will also stop the auto update function.

# 5. OPERATION

## General operation

### Switching the TV set on and off

To switch the TV set on, press the  button located on the right side of the set.  
*When the set is on, the indicator on the front is green.*

### Standby mode

Press the  button on the screen right side of TV or on the remote control.  
The TV set remains powered up, but with low energy consumption.  
*When the TV set is in standby mode, the indicator on the front is red.*

### Quitting standby mode

- Press the  or any numeric button on the remote control,
- press the **PR+/PR-** buttons to switch on the television at the last channel or AV programme you were watching,
- press the **AV** button to switch the television on at the last AV programme you were watching.

### Volume

Volume control: use the **VOL + /-** buttons on the right side of the TV set or press the same buttons on the remote control to increase or decrease the volume.

Sound mute: press the  button to temporarily mute the sound. Press this button again or the **VOL+** button to restore it.

### Displaying status information

**In TV mode**, press the yellow button (**INFO**) on the remote control to display the number and name of the channel you are watching, **the type of sound, the zoom or format type, sound mute status and the sleep timer status (if active).**

TV lock message is displayed if the function is activated under the **PREFERENCES** menu.

When you switch on the television or change channels, the number and name of the channel are displayed if you entered its name under the **ORGANISER** menu.

**In PC and PIC(see page 21)** modes, press the yellow button (**INFO**) on the remote control to display the **Resolution, Vertical and Horizontal frequency.**

### Accessing channels

Using the numeric buttons:

- for channels 1 to 9, press the corresponding button.
- for channels 10 to 99, press the 0 button to display "--", then enter the two digits.

Using the **PR+/PR-** buttons: scroll through the channels.

*AV programmes are not included in the cycle unless you use the buttons on the right side of the TV set.*

### Accessing AV programmes

Press the **AV** button to display the last selected audio-visual programmes and scan through the other audio-visual programmes.

AV selections loop: AV1, AV1RGB, AV2, AV2-S, YCrCb, YPrPb, DVI (Depending on model), PC.

## Zoom

In TV mode, you have the option of changing the display format and using the zoom function via the < / > buttons. **Here is selections of Zoom:**

**4/3 Format** - picture in 4/3 format

**Zoom 14/9** - picture in 14/9 letterbox format

**Zoom 16/9** - picture in 16/9 letterbox format

**Zoom 16/9 up** - picture in 16/9 letterbox format moved up for subtitles

**Cinerama** - Cinerama

**16/9 Format** - picture in 16/9 format

**Note** : *The Zoom type can't be change when menu appears on the screen. In Teletext mode, the screen always 4/3 format but if exiting the Teletext mode, the screen will return the former Zoom level.*

When user changes the zoom format, the zoom status will appear temporarily at the bottom of the screen.

## Panning function for Zoom

In 14/9 Zoom, 16/9 Zoom, or 16/9 Zoom up, user can shift the picture up and down temporarily by using ▲ ▼ button and the panning icon will display.



When the picture reach the uppermost position for the zoom level, the panning icon will show :



When the picture reach the lowest position for the zoom level, the panning icon will show :



## Last programme

Press the **RETURN** button to return to last watched programme.

## Freeze

Press **OK** button in TV mode to freeze the picture. Press again **OK** button to unfreeze the picture.

## Adjusting the sound

<p>◀ SOUND</p> <p>Return</p> <p>Preset Standard...</p> <p>Balance ----- -----</p> <p>Sound type Stereo...</p> <p>Auto. volume leveling <input type="checkbox"/></p> <p>Internal speakers <input checked="" type="checkbox"/></p> <p>Advanced settings ...</p>	<p>Display the <b>OVERVIEW</b> menu by pressing the <b>MENU</b> button.</p> <p>Select the <b>Sound</b> option and press <b>OK</b> to confirm.</p> <p>The <b>SOUND</b> menu appears with the following options:</p>
---	--

**Return** : go back to **OVERVIEW** menu

**Preset** : use the ◀ or ▶ button to select the appropriate setting (**Standard, Film, Voice, Music and Personal**) for the programme you are watching.

**Personal** option contains the values you have defined for Equalizer settings.

**Balance**: use the ◀ or ▶ button to balance the sound between the right and left speakers.

**Sound type**: this option is used to select the appropriate sound type (**Automatic, Stereo, Sound 1, Sound 2, Sound 3, Nicam, Mono**).

*The available options depend on the programme you are watching.*

*The table at the bottom of this page indicates the sound types available for each type of broadcast.*

**Auto. volume leveling**:. Tick the box using **OK** button if you want to keep the same sound level on all the channels.

**Internal Speakers**: the TV set's speakers are enabled by default - the box is checked.

You can connect amplified speakers or an amplifier to the TV LCD (see the "**Other information**" chapter). You can then get the most out of the sound using all the speakers or you can disable the internal speakers.

Uncheck the box to do this, by pressing **OK** to confirm.

**Advanced Settings**: Press **OK** to access following options.

**Treble ,Mid Treble, Medium, Mid Bass, Bass** (Equalizer): select each band in turn and make the necessary adjustments by using the ◀ / ▶ buttons.

*These settings are automatically stored under **Personal** in the **Preset** option.*

**Dolby Virtual** : Check the box by pressing **OK** to enable **Dolby Virtual** effect setting.

**Surround effect**: adjust the surround effect as required using the ◀ / ▶ buttons.

Press **EXIT** to close the menu or select the option **Return** and press **OK** to return to the **SOUND** menu.

Broadcast	Options
Mono	Automatic, Mono
Nicam mono	Nicam, Mono
Nicam / IRT stereo	Stereo, Mono
Bilingual Nicam	Sound 1, Sound 2, Sound 3
Bilingual IRT	Sound 1, Sound 2
AV	Stereo, Sound 1, Sound 2

Manufactured under license from  
Dolby Laboratories.

"Dolby", and the double-D symbol are  
trademarks of Dolby Laboratories.



## Adjusting the picture

The **PICTURE** menu can be used to adjust the current settings, to apply preset settings and define your own preferred settings.

<p> <b>PICTURE</b></p> <p>Return</p> <p>Preset                      Studio...</p> <p><b>Brightness</b>              ----- -----</p> <p>Contrast                      ----- -----</p> <p>Colour                      ----- -----</p> <p>Sharpness                      ----- -----</p> <p>Tone                      Warm...</p> <p>Other settings              ...</p>	<p>Display the <b>OVERVIEW</b> menu by pressing the <b>MENU</b> button.</p> <p>Select the <b>Picture</b> option and press <b>OK</b> to confirm.</p> <p>The <b>PICTURE</b> menu appears. It offers the following options:</p>
--	--

**Return:** use the buttons to go back to the **OVERVIEW** menu

**Preset:** use the < / > buttons to select from the preset settings offered (**Standard, Film, Sport, Studio, Personal**) the one which suits best the programme you are watching.

The **Personal** option contains the values you have defined for **Brightness, Contrast, Colour** and **Sharpness** settings.

**Brightness, Contrast, Colour, Sharpness:** adjust these settings as required using the < / > buttons.

**Brightness, Contrast, Colour** and **Sharpness** settings are automatically stored under **Personal** in the **Preset** option

**Preset, Colour** and **Sharpness** options are not displayed in **PC** mode.

**Tone:** this options controls colour temperature.

Use the < / > buttons to select between **Cold, Neutral** and **Warm**.

**Other settings:** *This option is not displayed in PC mode.*

Press **OK** to access following options.

**Return:** use the buttons to go back to the **PICTURE** menu

**Noise Reduction:** adjust the noise reduction strength by using the < / > buttons.

You can choose between **Off, Low, Medium** and **High**.

**Black Expand :** adjust these settings as required using the < / > buttons.

You can choose between **Off, Low, Medium** and **High**.

**Auto format:** by default, checkbox is on

*The TV (16/9) adapts to the broadcast picture format if the equipment connected via a Euro-AV (scart) socket provides a control signal.*

*With AV2 and Component YCrCb, Auto format is not displayed.*

**Tint:** This option is only available for NTSC audio-visual sources.

Adjust the tint of the picture using the < / > buttons.

If the device is in **PC** mode you can access following functions in **Picture** Menu.

### **Phase, Synchronization, V-Position, H-Position**

Select the desired option and adjust as required by using the < / > buttons.

Press **EXIT** to close the menu.

**Note :** pressing **PRESETS** button (Red) in TV or PC mode out of the menus opens the **PICTURE** menu with the **Preset** line highlighted.



## Setting the Preferences

The **Preferences** menu can be used to set your preference including **Eco mode**, **Permanent PR**, **Back light**, **Sleep timer**, **TV Lock** and **Language**.

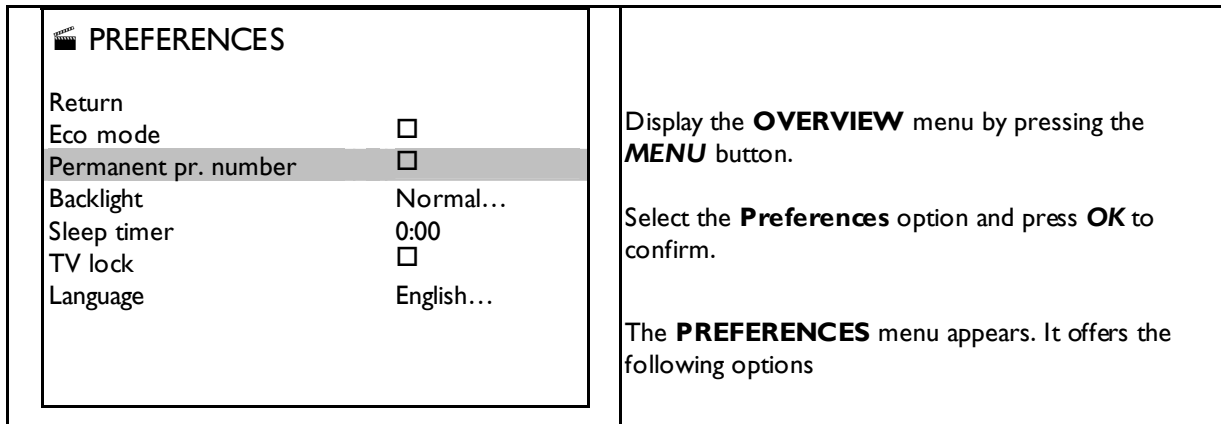

**Note:** *TV, PC and DVI mode have the same Preferences Menu*

**Return:** use the buttons to go back to the **OVERVIEW** menu.

**Eco mode:** When this function is on, the LCD TV will go to stand by automatically after ten minutes without video signal. Tick the box by pressing **OK** to activate the function.

If in PC or DVI mode, this Eco mode selection will enable the PC power management function.

**Permanent pr. number:** tick the box by pressing **OK** to permanently display the number of the channel you are watching.

*If the signal source is AV, the AV OSD tag will be displayed permanently.*

**Back light:** this option allows to adjust the backlight of your LCD TV. Using the **< / >** buttons you can choose between **Soft**, **Normal** and **Bright**.

**Sleep timer :**

1. Select the **Sleep timer** option.
2. Set an automatic shut-off time (from 0 to 4 hours in 15-minute intervals) by using the **< / >** buttons. Set the time to 00:00 to disable this function.

### TV Lock

This function allows the parents:

Either to lock the LCD TV set by putting it into to standby mode or to choose a programme their children will be able to watch until the sleep timer expires.

Tick the box by pressing **OK** to activate the TV lock.

*When you turn on the function, we suggest taking remote control away. In this case, children can only adjust the volume or switch the LCD TV off.*

*Once in standby mode, TV LCD can then only be switched on using the remote control.*

### Language

Using the **< / >** buttons select your preferred language for menus.

Available languages are : English, French, German, Italian, Spanish .

Press **EXIT** to close the menu.

**Note:** *pressing Zzz (Green) in TV mode out of the menus opens the PREFERENCES menu with the Sleep timer line highlighted.*

## Teletext

The Teletext service is available in many countries under a variety of names (TOP Text, Fastext, FLOF text, Videotext). It is provided as a free service by television broadcasters. This service provides a real wealth of information, available at any time, on weather, sports results, news, games, etc. The information is presented in pages or organised in topics specified in colour on the screen and you can access this information by simply pressing the buttons of the relevant colour on the remote control.

### Accessing Teletext

Press the **TEXT** button on the remote control. Teletext will display the last page selected, or if you have changed channel, the index page.

To display a page, enter its 3-digit number or use the **PR+/PR-** buttons. The page appears after a few moments.

### Navigation bar

The navigation bar, located at the bottom of the screen, provides access to the next three pages and the previous page by pressing the relevant colour button on the remote control.

AS the picture for example:

Press **red** to page 201; Press **green** to page 202; press **yellow** to page 203; press **blue** to page 199

Press the **MENU** button to display the navigation bar and access the following functions:

**STOP**: this function is used to stop pages from following on in succession. Press the **red** button to select this function. The word **STOP** (or an icon) appears in place of the page number.

Press the **red** button again to allow the pages to follow on again.

**???** (hidden answers): press the **green** button to reveal a hidden answer (for example, in games). Press the green button again to hide the answer.

**ZOOM**: press the **yellow** button:

1st key press: page is zoomed in and displays rows 1 to 12

2nd key press: the page is zoomed and displays rows 13 to 24

3rd key press: the page returns normal size and displays full page.

**MIX** (mixed display): press the **blue** button to display Teletext against a transparent background. Press this button again to return to normal display.

### Changing the character set temporarily

You can change the character set used for Teletext, if the existing one is not suitable for the channel you are watching.

You do this by pressing the **MENU** button to display the navigation bar.

Then press **OK** to display the number of the character set currently being used in place of **???**.

Use the **green** button to select another character set.

The character set selected in the INSTALLATION menu will be restored when the TV set is switched off or enters standby mode, or when you change channels.

Press the **EXIT** button to quit the Teletext function.

**Note** : *In teletext mode, the Vol+/Vol and Mute are still functional but on screen will not show volume bargraph and mute symbol*

### Other Teletext functions

#### Newsflash

When a newsflash is detected, **MIX** is replaced by **N** in the navigation bar. Press the blue button to display the newsflash. In the case of an update, the Teletext function is enabled and displays the new information.

This function is disabled if TV changes the programme, enters standby mode or is switched off.

Press the **EXIT** button to quit the Teletext function and return to **TV** mode.



## Subtitles

Some channels provide subtitles for some of their programmes. The number of the relevant pages is specified on the Teletext index page.

To display subtitles, enable the Teletext function, find the number of the page displaying the subtitles and enter it. Once the relevant page is found, the subtitles appear in the TV picture. The navigation bar disappears after a couple of seconds. To display the top bar, press the purple (**TEXT**) button.

Press the **EXIT** button to quit the Teletext function.

## Direct access to subpages

Some information is spread across more than one page ("----" displayed next to the page number). To access subpages, press the ◀ or ▶ button.

Enter the subpage number(4 digits) by using the numeric buttons.

To cancel subpage mode, please select a new page number by pressing **PR+/PR-**, press the ◀ or ▶ button, or change channels.

## Fastext

If Fastext is available, direct access to previous and subsequent pages is replaced by coloured bars (red, green, yellow and blue), which provide links to the topics you can access by pressing the relevant colour button. Other topics accessible in the same way can also be displayed. Press the **MENU** button to go from these links to the navigation bar.

## 6. OTHER INFORMATION

### PIC (Picture in Computer Mode)

When you have connected the PC to TV set (in **PC** mode), you can open the function by pressing **PR+/PR-** and you will watch programme displayed on the top right of the screen.

The picture size is not adjustable, you may move the picture position from top left, top right, bottom left, bottom right by pressing the **▲ / ▼** key.

The sound will always come from the programme inside the PIC no matter whether the PC is playing video file; however, inside **PIC** there is **no overview function** for it but you can change the video input type such AV1, AV2, AV2-S etc.

PIC is 4/3 picture format and the programme number will permanently display in yellow colour.

You may choose the channel of picture by pressing numeric number (0-9).

**Sockets:** at the bottom of the TV back side (From right to left)

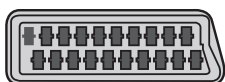

#### **SCART socket AVI** (input-output)

This socket can be used to connect a range of equipment, including video recorders, camcorders (VHS or 8-mm), decoders, satellite receivers, DVD players, games consoles or appliances producing an RGB signal.

*To display images from the connected appliance, select **AVI** using **AV** button on the remote control.*

*For some appliances (connected to the SCART socket), this selection is made automatically. For appliances producing an RGB signal, select **AVI RGB**.*



**RF signal** (Input) for the TV antenna or cable system using defined broadcasting standards such as BG (Euro), LL' (FR), I (UK) and DKK'(DK).

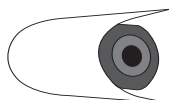

**Audio stereo jack socket** (output) This can be used to connect a stereo amplifier, a hi-fi system or amplified speakers (see below).

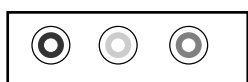

#### **Audio (R/L) and video (CVBS) CINCH sockets AV2** (input)

These can mainly be used to connect camcorders (VHS or 8-mm format).

*To display images from the connected appliance, select **AV2** using **AV** button on the remote control.*



#### **S-video socket AV2 and Audio (R/L)** (input)

These can mainly be used to connect camcorders (S-VHS or Hi 8 format).

*To display images from the connected appliance, select **AV2-S** using **AV** button on the remote control*

*CVBS and S-Video share the same L/R audio input.*

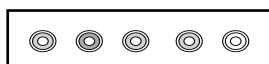

#### **YCrCb component and Audio (R/L)** (input)

YCrCb is for interlacing signal and mainly be used to connect DVD player.

*To display images from the connected appliance, select **YCrCb** using **AV** button on the remote control.*





### **YPrPb (for Video), D-Sub (for PC) and Audio (input)**

LCD TV uses D-Sub (15 pin) connector for YPrPb signal source and the D-Sub also can be used for PC input.

**Note:** *This model only supplies D-Sub to component line*

YPrPb is for progressive signal and mainly be used to connect DVD player or HDTV. Connect the stereo sound input jack on the back of the LCD TV (near the D-sub connector) to the audio output terminal of equipment.

*To display images from the connected appliance, select YCrCb using AV button on the remote control.*



### **DVI and DVI Audio input(R/L)(input) (Depending on model)**

DVI is digital video interface for PC and Video use but LCD TV DVI connector main function is for PC input only

### **Connecting active speakers or an amplifier (using a jack / CINCH cable not provided).**

The audio stereo jack socket located on the back of the LCD TV set can be used to connect active speakers (with a built-in amplifier) or an amplifier.

Connect the left and the right speaker to the stereo jack socket using a jack / CINCH cable (not provided). To connect an amplifier, you should connect the LCD TV set's stereo jack socket to the amplifier's L and R inputs using a jack / CINCH cable (not provided).

### **Connecting headphones**

Use the relevant socket on the right side of the LCD TV set to connect headphones or stereo earphones.

### **Connecting a video recorder**

To obtain optimum picture quality, use a SCART cable. However, you can also connect a video recorder to the television using the aerial socket.

If you connect a video recorder only via the aerial socket (without using the SCART socket), switch it on and play a tape.

Then search for the video recorder's relevant channel (refer to the relevant section).

If you connect a video recorder via the aerial socket, you should assign channel 99 to it in order to improve the picture quality when tapes are being played and in pause mode. However, we recommend you connect your video recorder via the SCART socket, as it provides better picture and sound quality.

## Connecting a Computer

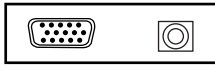

### Method A :

Connect the D-sub signal terminal on the back side of the LCD TV to the output of PC equipment through min D-sub 15 pin cable.

Connect the stereo sound input jack on the back of the LCD TV to the audio output terminal on the computer.

*To display images from the connected computer, select **PC** using **AV** button on the remote control*



### Method B : (Depending on model)

Connect the DVI signal terminal on the back side of the LCD TV to the output of PC equipment through min DVI cable.

Connect the stereo sound input jack (Audio input near DVI connector) on the back of the LCD TV to the audio output terminal on the computer.

*To display images from the connected computer, select **DVI** using **AV** button on the remote control*

### Note:

1. The display native resolution is 1280 x 720. If the signal resolution exceeds the native resolution, it may not be possible to show fine detail with sufficient clarity.
2. An adapter is required to use the PC cable (D-sub 15P) to connect a Macintosh computer to the set.
3. Some PC models cannot be connected to the set.
4. There is no need to use an adapter for computers with DOS/V compatible D-sub 15P terminals.
5. Do not set the horizontal and vertical scanning frequencies for PC signals, which are above or below the specified frequency range.

For more information about external device connections, see the manuals of your external devices.



# TROUBLE SHOOTING

Before you call for service, determine the symptoms and make a few simple checks as shown below.

## TV set:

SYMPTOMS	POSSIBLE CAUSES
Power does not turn ON	<ul style="list-style-type: none"> <li>• Ensure whether the power plug is securely inserted into the receptacle.</li> </ul>
There is no picture or sound	<ul style="list-style-type: none"> <li>• Ensure the LCD TV power is ON (Indicated by the green LED on the front of the unit)</li> <li>• Reception other than those of broadcasting stations can be considered.</li> <li>• Check for connection to wrong terminal or for wrong input mode.</li> <li>• Ensure the communication cable is properly connected between the Video Source and the LCD TV.</li> </ul>
There are spots on the screen	<ul style="list-style-type: none"> <li>• Check whether your AV equipments is affected by interference from automobiles, trains, high-voltage transmission lines, neon signs or other potential sources of interference.</li> </ul>
Degraded colors or tints	<ul style="list-style-type: none"> <li>• Check whether all image adjustments have been properly adjusted.</li> </ul>
Improper screen position or size	<ul style="list-style-type: none"> <li>• Check whether screen position and size have been properly adjusted.</li> </ul>
The image appears distorted	<ul style="list-style-type: none"> <li>• Ensure the TV's aspect ratio is properly set.</li> </ul>
The image is purple	<ul style="list-style-type: none"> <li>• Check the "Component" or "RGB" setting in the LCD TV and set it for the appropriate signal type.</li> </ul>
The image appears too bright, and there is a loss of definition in the brightest areas of the image.	<ul style="list-style-type: none"> <li>• Check whether the contrast setting is too high.</li> <li>• The DVD player is set for a high-level output.</li> <li>• The video signal has not been terminated properly somewhere in the system.</li> </ul>
The image appears too 'washed out', or the darkest areas of the image appear too bright.	<ul style="list-style-type: none"> <li>• Check whether Brightness is set too high.</li> <li>• The DVD player may be set at too high a brightness level.</li> </ul>
If "xxx searching" appears, the image or signal cannot be produced by display.	<ul style="list-style-type: none"> <li>• Check the cable for disconnection.</li> <li>• Check for connection to proper terminal or for proper input mode.</li> </ul>
"Out of range" appears	<ul style="list-style-type: none"> <li>• Check whether the input signal is acceptable to the display.</li> </ul>
Remote Control does not function properly	<ul style="list-style-type: none"> <li>• Check for incorrect battery orientation.</li> <li>• Check for dead batteries</li> <li>• Check for distance and angle from the display.</li> <li>• Check whether remote control is properly being pointed at the display's receiver.</li> <li>• Check for any obstacle between the remote control and the display.</li> <li>• Check that the remote sensor window is not under strong fluorescent lighting.</li> </ul>
There is no picture or sound, just noise.	<ul style="list-style-type: none"> <li>• Make sure the antenna cable is properly connected.</li> <li>• Consider whether TV signals are being properly received.</li> </ul>
Picture is not clear.	<ul style="list-style-type: none"> <li>• Make sure the antenna cable is properly connected.</li> <li>• Consider whether TV signals are being properly received.</li> </ul>
No sound	<ul style="list-style-type: none"> <li>• Check whether you have selected "Mute" for Audio setting.</li> <li>• Make sure the volume is not set to minimum.</li> <li>• Make sure that headphones are not connected.</li> <li>• Check cables for disconnection.</li> </ul>



## Antenna:

SYMPTOMS	POSSIBLE CAUSES
The picture is not sharp or the picture moves.	<ul style="list-style-type: none"><li>• The reception may be weak.</li><li>• The state of the broadcast may also be bad.</li><li>• Make sure the outside antenna is not disconnected.</li><li>• Make sure the antenna is facing the right direction.</li></ul>
The picture is doubled or tripled.	<ul style="list-style-type: none"><li>• Make sure the antenna is facing the right direction.</li><li>• There may be reflected electric waves from mountains or buildings.</li></ul>
The picture is spotted.	<ul style="list-style-type: none"><li>• There may be interference from automobiles, trains, high voltage lines, neon lights, etc.</li><li>• There may be interference between the antenna cable and power cable. Try positioning them further apart.</li></ul>
There are stripes on the screen or colors fade.	<ul style="list-style-type: none"><li>• Is the unit receiving interference from other devices? Transmission antennas of radio broadcasting stations and transmission antennas of amateur radios and cellular phones may also cause interference.</li><li>• Use the unit as far apart as possible from devices that may cause possible interference.</li></ul>



## HELPLINE THOMSON

You can contact THOMSON by dialling: **0871 712 1312**  
(For Great-Britain, all calls will be charged at 0.10 £ / mn)  
[www.thomson-europe.com](http://www.thomson-europe.com)

## Free Manuals Download Website

<http://myh66.com>

<http://usermanuals.us>

<http://www.somanuals.com>

<http://www.4manuals.cc>

<http://www.manual-lib.com>

<http://www.404manual.com>

<http://www.luxmanual.com>

<http://aubethermostatmanual.com>

Golf course search by state

<http://golfingnear.com>

Email search by domain

<http://emailbydomain.com>

Auto manuals search

<http://auto.somanuals.com>

TV manuals search

<http://tv.somanuals.com>