

THOMSON

user
manual

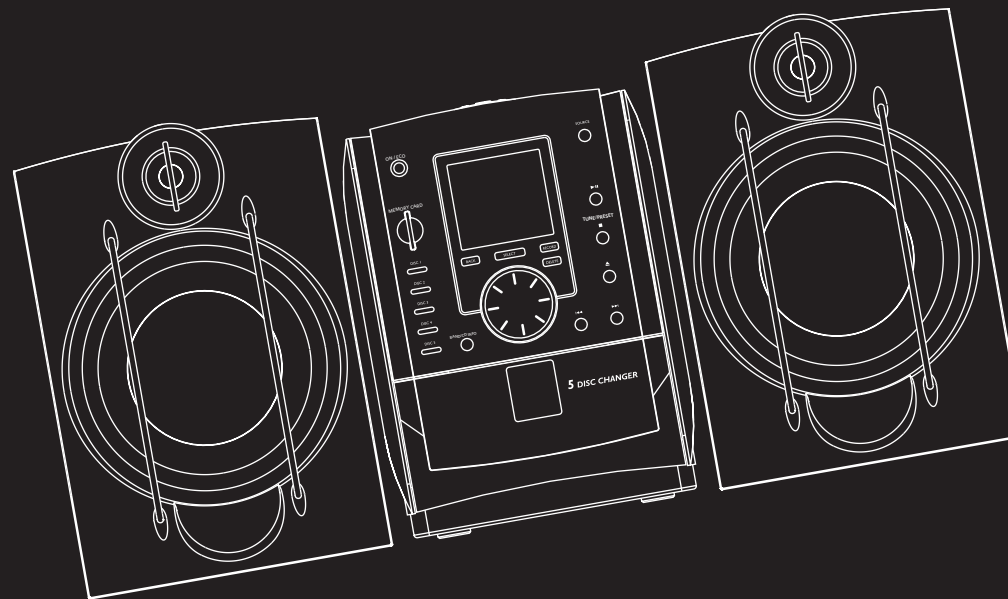

THOMSON
46, quai Alphonse Le Gallo
92648 Boulogne
Cedex FRANCE
www.thomson.net

5605618A

CS600

It is important to read this instruction book prior to using your new product for the first time.

Safety Information

EN For UK Only

CONNECT THE MAIN LEAD INTO A MAINS POWER SOCKET

POWER SUPPLY **230V**. It must not be connected to D.C. mains.

Note: The mains lead of the set is fitted with a molded plug. If the mains socket are not compatible or if for any reason the plug is removed please follow the directions below. The molded plug cannot be rewired and if removed must be disposed of safely.

DO NOT under any circumstances plug the severed plug into any mains socket as this could result in electric shock.

Important: If the plug is removed, rewire the new plug as follow:
The wires in the mains plug are colored in accordance to the following code:

BLUE = NEUTRAL / BROWN = LIVE

If the colors of the wires in the mains lead of this apparatus may not correspond with the colored markings identifying the terminals in your plug, proceed as follows:

BLUE wire to the terminal coded N (Neutral) or colored black.

BROWN wire to the terminal coded L (Live) or colored red.

DO NOT make any connection to the terminal in the plug which is marked by the letter E or by the earth symbol or colored green or green and yellow.

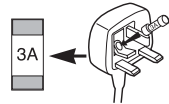

A fused plug must be fitted with a 3A fuse approved by ASTA or BS1362 and fuse covers must be always be securely replaced. If you set does not work, the fuse may be blown.

	CAUTION RISK OF ELECTRIC SHOCK DO NOT OPEN	
THE LIGHTNING FLASH AND ARROW-HEAD WITHIN THE TRIANGLE IS A WARNING SIGN ALERTING YOU OF "DANGEROUS VOLTAGE" INSIDE THE PRODUCT.	CAUTION: TO REDUCE THE RISK OF ELECTRIC SHOCK, DO NOT REMOVE COVER (OR BACK). NO USER-SERVICEABLE PARTS INSIDE. REFER SERVICING TO QUALIFIED SERVICE PERSONNEL.	THE EXCLAMATION POINT WITHIN THE TRIANGLE IS A WARNING SIGN ALERTING YOU OF I M P O R T A N T INSTRUCTIONS ACCOMPANYING THE PRODUCT.
SEE MARKING ON BOTTOM / BACK OF PRODUCT		

WARNING: TO PREVENT FIRE OR ELECTRICAL SHOCK HAZARD, DO NOT EXPOSE THIS PRODUCT TO RAIN OR MOISTURE.

Safety Information

CAUTION!

Invisible laser radiation when open. Avoid exposure to beam. Class 1 laser product. This system must be opened only by qualified technicians to prevent accidents caused by the laser beam.

LASER $\lambda = 780 \text{ nm}$, P max = 5 mW

Rating Information: At bottom/rear of the unit.
This unit comply with the existing requirements

In accordance with the rating plate of the unit, this unit complies with current standards concerning electrical safety and electromagnetic compatibility.

Please respect the environment Before throwing any batteries away, consult your distributor who may be able to take them back for specific recycling.

Have a Blast- Just Not in Your Eardrums
Make sure you turn down the volume on the unit before you put on headphones. Increase the volume to the desired level only after headphone are in place.

ADVARSEL!
USYNLIG LASERSTRÅLNING VED ÅBNING NÅR SIKKERHEDSAFBRYDERE ER UDE AF FUNKTION. UNGDÅ UDSÆTTELSE FOR STRÅLNING.
VORSICHT!
UNSICHTBARE LASERSTRALUNG WENN ABDECKUNG GEÖFFNET UND SICHERHEITS-VERRIEGELUNG ÜBERBRÜCKT.
NICHT DEM LASERSTRAHL AUSSETZEN!

CAUTION - INVISIBLE LASER RADIATION WHEN OPEN AND INTERLOCKS FAILED OR DEFEATED. AVOID EXPOSURE TO BEAM.
ATTENTION - RAYONNEMENT LASER INVISIBLE DANGEREUX EN CAS D'OUVERTURE ET LORSQUE LA SECURITE EST NEUTRALISEE. EXPOSITION DANGEREUSE AU FAISCEAU.



CLASS 1 LASER PRODUCT
LASER KLASSE 1
APPAREIL A LASER DE CLASSE 1
LUOKAN 1 LASERLAITE
KLASS 1 LASERAPPARAT

VARNING-
OSYNLIG LASERSTRÅLNING NÅR DENNA DEL ÄR ÖPPNAD OCH SPÄRRAN ÄR URKOPPLADE. BETRAKTA EJ STRÅLEN.
VARO!
AVÄRTAESSA JA SOUJALUKITUSOHITETTAESSA OLET ALTTIINA NÄKYMÄTTÖMÄLLE. LASERSÄTEILYLLE ÄLÄ KATSO SÄTEESEEN.

Portions based upon Microsoft Windows Media Technologies. Copyright © 1999 Microsoft Corporation. All Rights Reserved. Microsoft, Windows Media, and the Windows Logo are trademarks or registered trademarks of Microsoft Corporation in the United States and/or other countries.

The descriptions and characteristics given in this document are given as a general indication and not as a guarantee. In order to provide the highest quality product possible, we reserve the right to make any improvement or modification without prior notice. The English version serves as the final reference on all products and operational details should any discrepancies arise in other languages.

Important Information

Safety Precautions

- Never open the cabinet under any circumstances. Any repairs or internal adjustments should be made only by a trained technician.
- Never operate this product with the cabinet removed.
- Do not use your System immediately after transporting it from a cold place to a warm place, as condensation may cause the system to malfunction.
- Keep your unit away from humid areas and abnormally hot places.
- Do not touch the player with wet hands. If any liquid enters the player cabinet, take the player to a trained technician for inspection.
- This compact disc player uses a laser to read the music on the disc. The laser mechanism corresponds to the cartridge and stylus of a record player. Although this product incorporates a laser pick-up lens, it is completely safe when operated according to directions.
- Discs rotate at high speed inside the player. Do not use damaged, warped, or cracked discs.
- Do not touch the pick-up lens which is located inside the disc compartment. To keep dust from collecting on the pick-up lens, do not leave the compartment door open for an extended period of time. If the lens becomes dirty, clean it with a soft brush, or use an air blower brush designed for camera lenses.
- The apparatus shall not be exposed to dripping or splashing and that no objects filled with liquids, such as vases, shall be placed on the apparatus.

- Minimum distances around the apparatus for sufficient ventilation .
- The ventilation should not be impeded by covering the ventilation opening with items, such as newspaper,table-cloths,curtains,etc.
- No naked flame sources,such as lighted candles,should be placed on the apparatus.
- Attention should be drawn to the environmental aspects of battery disposal .

Precautions for the mp3 Player

- Do not use the unit immediately after transportation from a cold place to a warm place; condensation problem may result.
- Do not store the unit near fire, places with high temperature or in direct sunlight.
- Do not operate or store unit in places with frequent static electricity or electrical noise (e.g. speaker, TV set).
- Clean the unit with a soft cloth or a damp chamois leather. Never use solvents.
- The unit must only be opened by qualified personnel.



Note:

This unit may temporarily cease to function if subjected to electrostatic disturbance. To resume normal operation, it may be necessary to cycle the power off and back on or to remove and reinstall the batteries.

Important Information

Important Battery Information

- Remove the batteries to avoid leakage if you do not use your remote control for more than one month.
- Discard leaky batteries immediately as leaking batteries may cause skin burns or other personal injuries. Dispose of batteries in the proper manner, according to provincial and local regulations.
- Any battery may leak electrolyte under the following circumstances:
 - if mixed with a different battery type,
 - if inserted incorrectly,
 - if all batteries are not replaced at the same time,
 - if disposed of in fire, or
 - if an attempt is made to charge a battery not intended to be recharged.

Headset Safety

- Do not play your headset at high volume. Hearing experts warn against extended high-volume play.
- If you experience ringing in your ears, reduce volume or discontinue use.
- You should use with extreme caution or temporarily discontinue use in potentially hazardous situations. Even if your headset is an open-air designed to let you hear outside sounds, do not turn up the volume so high that you are unable to hear what is around you.

Caution While Driving

Use of headphones while operating an automobile or moving vehicle is not recommended and is unlawful in some states and areas. Be careful and attentive on the road. Stop operation of the unit if you find it disruptive or distracting while driving.

Care of Memory Card (Not Included)

- Do not touch the golden electrodes.
- Use a soft dry cloth to clean any dirt.
- Do not bend Memory Cards.
- Do not operate or store the MultiMediaCards in places with frequent static electricity or electrical noise (e.g. speaker, TV set). Recorded data may be damaged.
- It is normal for Memory Card to get warm after being used for a long time.
- Always put it in storage case after removing from the unit.
- Do not store Memory Card near fire, places with high temperature/ humidity or in direct sunlight.

Don't Infringe

This product should only be used for the purposes for which it is sold, that is, entertainment, violating no copyright law. Any attempts to use this product for which it is not intended is unlawful and therefore not condoned by Thomson.

Your THOMSON product is designed and manufactured with high quality materials and components which can be recycled and reused.

 This symbol means that electrical and electronic equipment, at their end-of-life, should be disposed of separately from your household waste.

 Please, dispose of this equipment at your local community waste collection/recycling centre.

In the European Union there are separate collection systems for

used electrical and electronic product.

Please, help us to conserve the environment we live in!

Table of Contents

EN

Safety Information

Important Information

Table of Contents1

Getting Started3

Unpacking the system	3
Back View	3
Using the FM and Am Antennas	4
Connecting the Speakers	4
Installation	4

General Controls5

Main Unit	5
Front View	5
Top View	6
Remote Control	6
Installing Batteries	7

Display8

Settings9

Showing Demonstration	9
Setting the Clock	9
Setting the Timer	9
Activating the Timer	9
Sleep Mode	10

Sound Features10

Volume Control	10
Bass Boost	10
Muting Audio	10
Preset Equalizer Curves	10
Creating Custom Curves	10

Navigation Controls11

File Navigation	11
Main Unit	11
Remote Control	11

CD Player12

Important CD and mp3/WMA Information ..	12
Notes on CD-R/RW Discs	12
Notes on mp3/WMA Discs	12
Loading Discs	13
Play and Pause Discs	13
Play and Load Simultaneously	13
Stop Playback	13
Selecting a Disc	14
Searching Through a CD	14
Sampling Tracks	14
Repeat	14
Random Playback	14

USB and Memory Card15

Connecting USB device to the Audio System	15
Inserting Memory Card	15
Selecting USB or Memory Card Mode	15
USB / Memory Card Playback Features	16
Start and Pause Playback	16
Stop Playback	16
Skipping Files	16
Sampling Tracks	16
Repeat	16
Random Playback	16
Memory Usage	16

Program17

Setting up Program	17
Playing Program	17

Table of Contents

EN

Display Program List	17
Remove Track/File from Program	17
Remov the Entire Program	17

Radio18

Selecting Tuner Band	18
Tuning to a Station	18
Using Presets	18
Auto Preset Programming	18
Manually Setting Presets	18
Suppressing Stereo Signal	18
Tuning to an RDS Station	19
Displaying RDS Station Information	19
Searching by Program Type (PTY)	19

Recording20

Recording CD to USB Device	20
Recording Standby	20
Instant Recording	20
Recording Tuner / AUX to USB Device	21
Deleting Files from USB Device or Memory Card	21
Deleting All Files	21

Troubleshooting Tips22

Maintenance24

Cleaning	24
CD Player	24
Handling CDs	24
Cleaning CDs	24
CD Lens Care	24
Technical Specification	24

Getting Started

EN

Unpacking the system

You should have the following:

- one main unit (with 2 main speakers);
- one remote control;
- one AM loop antenna;
- one user's guide;
- one safety leaflet;
- Guarantee card



Warning:

Use of this product is for your personal use only. Unauthorized recording or duplication of copyrighted material may infringe upon the rights of third parties and may be contrary to copyright laws.



Note:

Make sure the tracks are encoded in mp3 or Windows Media formats and supported bitrates. Bitrates supported by the player:

mp3 - 32 to 320kbps
wma - 48 to 160kbps

Back View

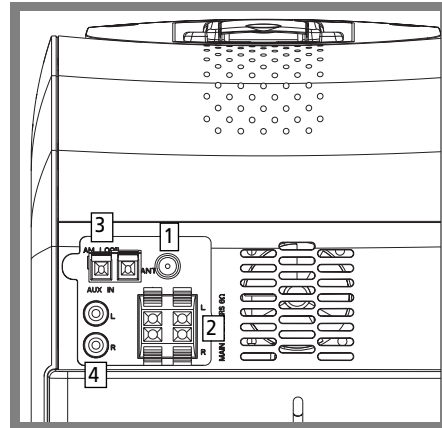

1. FM Antenna.
2. Main Speaker Jacks.
3. AM Loop antenna Jacks.
4. AUX IN

Getting Started

EN

Using the FM and AM Antennas

Before you use your audio system, you'll want to make sure both the FM and AM antennas are positioned properly. Uncoil the FM antenna at the back of the unit, making sure it is fully extended (you may even want to tape it to the wall behind the unit if possible. The higher the better.) You'll also need to connect the AM antenna loop to the back of the unit if you listen to AM stations. Rotate the AM loop antenna for better reception.

Connecting the Speakers

Each speaker has a black (negative) and a red (positive) jack. When connecting the speakers, match the red wires to the red jacks and the black wires to the black jacks.

Speaker Wire Connection

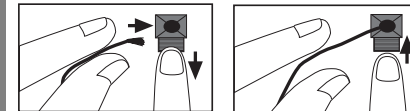

Push Speaker terminal tab down to insert wire.

Release tab to lock wire in the terminal.

NOTE: Make sure the insulation is completely removed from the ends of the speaker wires at all connection points.

Installation

To ensure sufficient ventilation, keep the spacings shown below free from other surfaces:

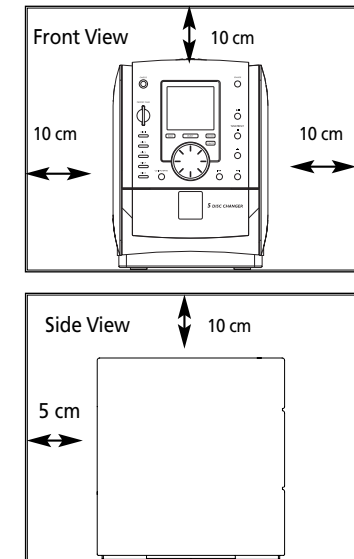

General Controls

EN

Main Unit - Front View

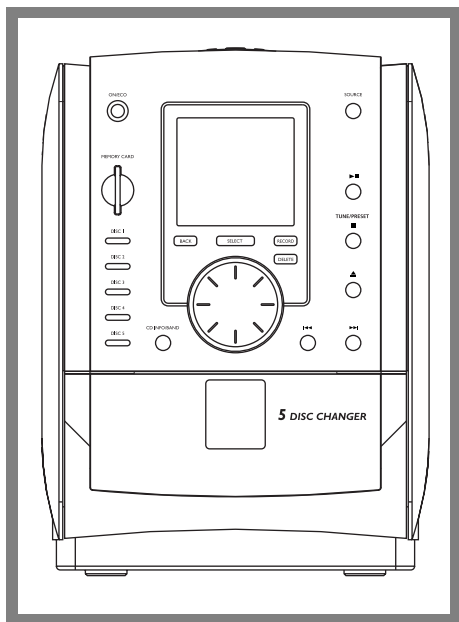

ON/ECO - Press and hold in standby mode to enter ECO (power saving, without clock display) mode. Press briefly to turn on and off the unit.



Tips:

In **STANDBY** mode, press **ON/STANDBY** to turn the system on in the previously used mode. Press **SOURCE** to select the corresponding mode. Look at the display icons to identify the current mode.

SOURCE - Selects among CD player, USB, memory card, tuner and AUX.

MEMORY CARD - Slot for inserting memory card.

DISC 1 / DISC 2 / DISC 3 / DISC 4 / DISC 5 - Direct access to the corresponding disc tray for playback.

PLAY/PAUSE - Starts and pauses playback for CD, USB and memory card.

STOP/TUNE/PRESET - Stops CD, USB and memory card operations, *In Tuner mode* - selects tune or preset mode.

OPEN/CLOSE - Opens or closes the disc tray.

SKIP BACKWARD - *In CD mode* - Goes to the previous CD track and setting options; searches backward through CD;

In USB and memory card mode - Skips to the previous file;

In Tuner mode - Tunes down radio frequency.

SKIP FORWARD - *In CD mode* - Goes to the next CD track and setting options; searches forward through CD;

In USB and memory card mode - Skips to the next file;

In Tuner mode - Tunes up radio frequency.

BAND/CD INFO - *In CD mode* - Selects display options to show track elapse time, track remain time or disc remain time.

In mp3 / WMA mode - Shows ID3 tag.

In USB / memory card mode - Shows memory usage.

In Tuner mode - selects radio band.

VOLUME CONTROL - Adjusts volume (except in navigation mode).

In mp3 / WMA / USB / memory card navigation mode - Rotate clockwise to navigate downwards and rotate counter-clockwise to navigate upwards.

SELECT - *In mp3 / WMA / USB / memory card stop mode* - Enters navigation mode.

In navigation mode - navigates forward.

BACK - *In navigation mode* - navigates backwards.

RECORD - Starts recording.

DELETE - Removes track from My Selections.

In USB / Memory Card mode - Deletes file from the connected mp3 player or memory card.

General Controls

Main Unit - Top View

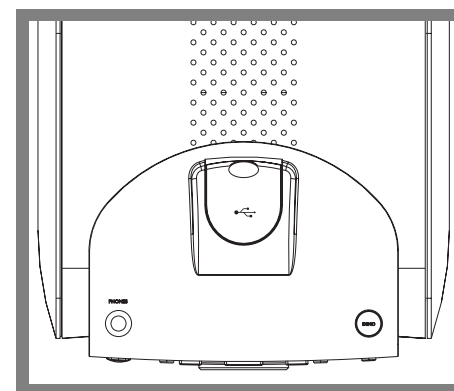

PHONES - Jack for connecting headphones.

DEMO - Activates and deactivates demonstration.

- USB Connector for connecting USB device (e.g. mp3 player).

Remote Control

EN

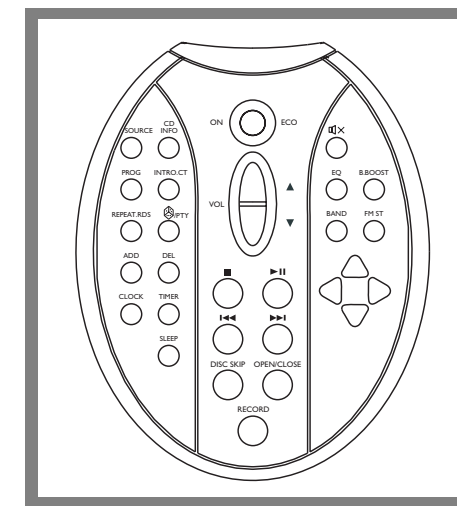

ON/STANDBY - Turns power on or off (**STANDBY** mode).

SOURCE - Selects among CD player, tuner, USB, memory card, and AUX.

CD INFO - *In CD mode* - Selects display options to show track elapse time, track remain time or disc remain time.

In mp3 / WMA mode - Shows ID3 tag.

In USB / memory card mode - Shows memory usage.

PROG - *In CD, USB and Tuner mode* - Enters program mode.

INTRO/CT - *In CD / USB / memory card mode* - Turns intro mode on or off to play the first 10 seconds of each track / file.

In RADIO mode - shows RDS time.

General Controls

EN

REPEAT/RDS - In CD mode - Repeats a track, CD or all CDs.

In RADIO mode - displays RDS information.

In USB / memory card mode - Selects repeat one file, repeat all files mode.

PTY - In CD / USB / memory card mode - Turns on/off random playback.

In RADIO mode - Selects search by program type in tune mode.

ADD - In CD / USB / memory card mode - Adds track / file to My Selections.

DEL - In CD / USB / memory card navigation mode - Removes track / file from My Selections.

In USB / memory card mode - Removes file from the connected mp3 player or memory card.

CLOCK - Displays clock time. Press and hold to enter clock setting mode.

TIMER - Enters timer setting mode. Activates and deactivates timer.

SLEEP - Selects the time interval in minutes before the unit turns off.

VOL ▼ or ▲ - Decreases or Increases volume level.

STOP ■ - In CD / USB / memory card mode - Stops playback;

PLAY/PAUSE ▶■ - In CD / USB / memory card mode - Starts and pauses playback.

SKIP BACKWARD ◀◀ - In clock and timer setting mode - Goes to the previous setting option. In CD / USB / memory card mode - Goes to the previous track; searches backward through CD;

In Tuner mode - Tunes down radio frequency.

SKIP FORWARD ▶▶ - In clock and timer setting mode - Goes to the next setting option. In CD / USB / memory card mode - Goes to the next track; searches forward through CD;

In Tuner mode - Tunes up radio frequency.

DISC SKIP - Skips to the next disc in CD mode.

OPEN/CLOSE - Opens and closes disc compartment.

RECORD - Starts recording.

MUTE - Mutes audio output.

EQ - Selects equalizer presets.

B. BOOST - Turns on or off Bass Boost.

BAND - In Tuner mode - selects radio band.

FM ST - Selects between stereo and mono sound in FM tuner mode.

UP △ - In navigation mode - Navigates upwards and move up a list.

In tuner mode - selects the next preset number.

DOWN ▽ - In navigation mode - Navigates downwards and move down a list.

In tuner mode - Selects the previous preset number.

LEFT/BACK ◀ - In navigation mode - Navigates backwards.

RIGHT /ENTER ▶ - In navigation mode - Navigates forward.

Installing Batteries

The remote control must be inserted with 2 "AAA" or "UM-4" or "R03" batteries prior to use. Follow the steps below to ensure correct installation.

1. Remove the battery compartment door (located at the back of the remote control) by sliding the compartment door in the direction of the arrow and then lifting the door out and off the cabinet.
2. Before inserting the batteries, observe the polarities (that is, + and -) of the battery, then relate the polarities to the engraved diagram inside the battery compartment. Now insert the batteries.
3. After installation of the batteries, replace the battery compartment door in place by sliding it in the opposite direction of the arrow (the reverse of step 1).

Display

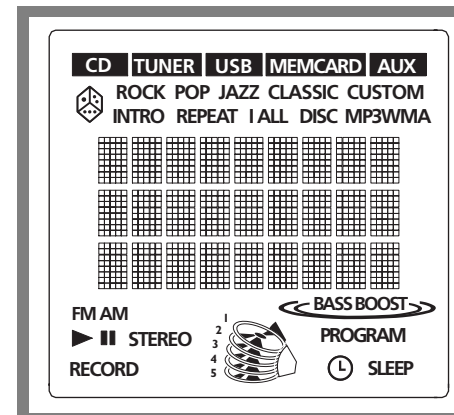

CD / TUNER / USB / MEMCARD / AUX - indicates the current mode.

INTRO - Random playback is activated in CD mode.

ROCK / POP / JAZZ / CLASSIC / CUSTOM - Current equalizer setting.

INTRO - In CD mode, intro is activated so the first 10 seconds of each track will be played.

REPEAT 1 / REPEAT 1 DISC / REPEAT ALL DISC / ALL DISC - In CD mode, indicates the repeat option that is activated.

REPEAT 1 - Repeats current track.

REPEAT 1 DISC - Repeats current disc.

REPEAT ALL DISC - Repeats all discs.

ALL DISC - Plays all discs once.

MP3 / WMA - Current CD format.

FM / AM - Radio band in tuner mode.

▶ - Currently in playback mode.

▶ II - Currently in pause mode.

STEREO - In FM tuner mode, indicates stereo sound is selected.

RECORD - Recording is activated.

BASS BOOST - Bass boost is activated.

PROGRAM - In program mode.

⌚ - Timer is activated.

SLEEP - Sleep is activated.

 - The corresponding disc icon lights to show which disc compartment is loaded. The current playing disc will flash.

EN

Settings

EN

Showing Demonstration

Press **DEMO** to turn on/off demonstration mode. The demonstration scrolls through all display operations.

Setting the Clock

1. Press and hold **CLOCK** on the remote control until the hour flashes on the display.
2. Press **SKIP BACKWARD** **◀◀** or **SKIP FORWARD** **▶▶** to set the hour and then press **CLOCK** to shift to minute digits.
3. Press **SKIP BACKWARD** **◀◀** or **SKIP FORWARD** **▶▶** to set the minute.
4. Press **CLOCK** to save settings and **STOP** **■** to quit setting.



Note:

When system is ON, you can press **CLOCK** to display the current time for about 2 seconds.

Setting the Timer

1. Press and hold **TIMER** on the remote control until Timer On and the clock hour flashes on the display.

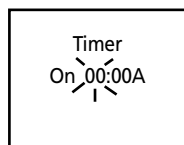

2. For setting time, press **SKIP BACKWARD** **◀◀** or **SKIP FORWARD** **▶▶** to set the hour and then press **TIMER** to shift to minute digits.

3. Press **SKIP BACKWARD** **◀◀** or **SKIP FORWARD** **▶▶** to set the minute.
4. Press **TIMER** to change to Timer Off setting with clock time flashing. Repeat steps 2 & 3 for timer off time setting.

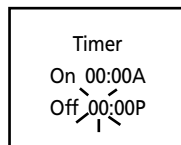

5. Press **TIMER** to select source. Press **SKIP BACKWARD** **◀◀** or **SKIP FORWARD** **▶▶** to select TUNER / TUNER REC / DISC / UDISC (USB) / CARD.

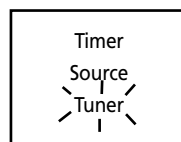

- If TUNER REC is selected, press **SKIP BACKWARD** **◀◀** or **SKIP FORWARD** **▶▶** to select the preset station.
6. Press **TIMER** to set volume. Adjust **VOLUME CONTROL** to select desired volume level.

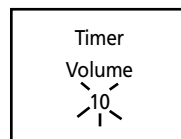

7. Press **TIMER** to save settings. Press **STOP** **■** to quit setting.

The timer is automatically activated once timer setting is saved.

Activating the Timer

Press and release **TIMER** to turn on/off the alarm. The timer icon  is displayed when timer is activated.

Settings

EN

Sleep Mode

You can select the time interval in minutes before the unit turns off automatically. Press **SLEEP** to select among OFF, 120, 90, 60, 45, 30, 15 and 5 minutes. The SLEEP icon lights on the display when sleep mode is activated.

View Remaining Sleep Time

When sleep is activated, press **SLEEP** once to view remaining sleep time.

Adjust Sleep Time

Press **SLEEP** again when the remaining sleep time is displayed to change sleep time.



Note:

Sleep is automatically de-activated when the unit is turned off.

Sound Features

Volume Control

Rotate the volume control on the main unit or press **VOL** **▲** or **▼** on the remote control to adjust volume level. The volume level shows briefly on the display.

Bass Boost

Press **B.BOOST** to turn on/off boosting the bass frequency. The BASS BOOST icon lights on the display when it is activated.

Muting Audio

Press **MUTE** on the remote to cut the sound (Remote Only). MUTE flashes on the display.

Using Preset Equalizer Curves

Press **EQ** to toggle among FLAT, ROCK, POP, JAZZ, CLASSIC and CUSTOM. The display shows your selection briefly and the relative icon lights on the display.

Creating a Custom Curve

1. Press **EQ** to select CUSTOM mode.
2. While CUSTOM is displayed, press **SKIP BACKWARD** **◀◀** or **SKIP FORWARD** **▶▶** to cycle among displayed bass and treble range levels.
3. While BAS and TRE is displayed, adjust volume control to set the associated gain between -10 - +10.
4. Press **EQ** to exit.

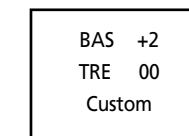

Navigation Controls

EN

File Navigation Main Unit

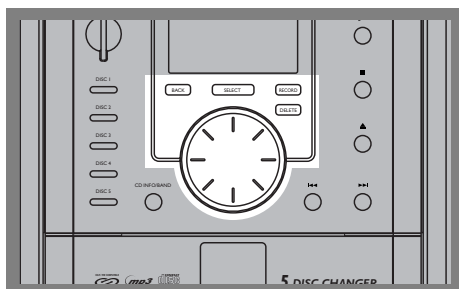

SELECT - Enters navigation mode from mp3 / WMA / USB / memory card stop mode. Enters selected folder in navigation mode. Begins playback of the selected file in navigation mode.

BACK - Goes back up one level in navigation mode; returns to stop mode from navigation mode when at root level.

DELETE - In mp3 / WMA / USB / memory card navigation mode - removes the selected file from My Selection.

In USB / memory card mode - Deletes selected file.

Volume Control - Rotate clockwise to navigate downwards.

Rotate counter-clockwise to navigate upwards.

Remote Control

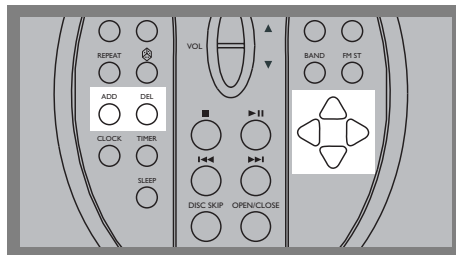

LEFT / BACK ◀ - Navigates backwards. Returns to the previous navigation menu level. Returns to stop mode from navigation mode.

RIGHT / ENTER ▶ - Navigates forward. Enters navigation mode from mp3 / WMA / USB / memory card stop mode.

Enters current folder and shows the first file/folder from current folder.

UP ▲ - Navigates upwards. Enters navigation mode from mp3 / WMA / USB / memory card stop mode.

Selects previous file/folder on the navigation menu.

DOWN ▼ - Navigates downwards. Enters navigation mode from mp3 / WMA / USB / memory card stop mode.

Selects next file/folder from the navigation menu.

ADD - In mp3 / WMA / USB / memory card navigation mode - adds the selected file into My Selection

DEL - In mp3 / WMA / USB / memory card navigation mode - Removes the selected file from My Selection when reviewing program.

In USB / memory card mode - Deletes selected file when reviewing program.

CD Player

Important CD and mp3/WMA Information



This unit is compatible with CD-RW/ CD-R discs for playback.



Notes on CD-R/RW Disc:

- Do not affix any type of labels to either side (recordable or labeled side) of a CD-R/RW disc as this may result in the unit malfunctioning.
- To avoid damages to the CD-R/RW disc, do not open the disc compartment door while the disc is being read.
- Do not load an unrecorded CD-R/RW disc into the unit. This may take a longer time to read the disc.
- **Playback capability for CD-RW discs may vary due to variations in the quality of the CD-RW disc and the recorder used to create the disc.**



Notes on mp3/WMA Disc:

- Use .mp3 as the extension when converting audio files into mp3 for saving onto CD-R(W) or CD-ROM, e.g. Abc08.mp3. Do not use any other extension e.g. .doc, .pdf.
- Do not use the .mp3 extension for other text or non-audio data files as this may result in serious malfunction and harmful noise interference.
- For better quality in mp3/WMA disc playback, the CD quality should be recorded 128kbps or above.
- Disc data size > 650MB is not recommended.
- Total files and folders in the disc should not exceed 250, it also depends on the length of the file/folder names.
- For mixed mode discs, only one mode will be selected for playback depending on the recording format.
- To ensure good performance, wait until the disc changer completely reads the disc before proceeding.
- mp3 files in CD ROM EXTRA format disc cannot be recognized.

EN

CD Player

EN

Loading Discs

1. Press **SOURCE** repeatedly to select CD mode.
2. Press **OPEN/CLOSE** \blacktriangle to open the disc compartment.
3. Insert up to 5 discs with label face up.
4. Press **OPEN/CLOSE** \blacktriangle again to close the disc compartment.

The occupied disc tray icons lights on the display and the current disc icon flashes on the display. If the disc is a mp3 / WMA CD, the respective MP3 and WMA icon lights on the display.



Note:

Be sure to remove all discs from the disc compartment before moving or transporting the unit!

Play and Pause Discs

- To play all discs in the disc compartment, - press **PLAY/PAUSE** $\blacktriangleright \parallel$ in stop mode to begin playback.
- To play a specific disc in the disc compartment, - press **DISC 1 - DISC 5** to play the corresponding disc. During mp3 / WMA playback, the display show ID3 tags (Title, Artist and Album).

Audio CD	mp3 / WMA CD
01 0:50	0:00 Folder Nm ID3 tag

- Press **PLAY/PAUSE** $\blacktriangleright \parallel$ during playback to pause disc. Press again to resume.

Play and load simultaneously by:

1. Press **OPEN/CLOSE** \blacktriangle to open the disc tray while a CD is playing.
2. Load/change discs for available trays.
3. Press **OPEN/CLOSE** \blacktriangle again to close the tray.



Attention:

Do not push to force closing of the tray during CD playback or tray opening.

Stop Playback

During playback, press **STOP** \blacksquare to stop playback. The unit returns to navigation mode briefly (approx. 10 seconds) before entering stop mode.

Navigation mode:
Audio CD

\blacktriangleright 01 3:31
\blacktriangleright 02 3:50
\blacktriangleright 03 4:08

mp3 / WMA CD

- ROOT
\blacksquare Folder 1
\blacktriangleright Song 1

Stop mode:

Audio CD

Audio CD
10 Tracks
74:30

mp3 / WMA CD

MP3/WMA
300Tracks

CD Player

EN

Repeat

Press **REPEAT** on the remote control to toggle repeat options:

Repeat the current track (REPEAT 1),
Repeat current disc (REPEAT 1 DISC),
Repeat all discs (REPEAT ALL DISC), or
Normal playback (ALL DISC).

Random Playback

Press SHUFFLE on the remote control to turn on/off random playback. The SHUFFLE icon is displayed when it is activated.

All the tracks on one disc will be shuffled and played once before shuffling and playing tracks from the next disc.



Tips:

In CD stop mode, press **UP** \blacktriangle , **DOWN** \blacktriangledown or **RIGHT / ENTER** \blacktriangleright to enter navigation mode and show disc menu.

In CD navigation mode, press **LEFT / BACK** \blacktriangleleft to return to stop mode.

Selecting a Disc

Press **DISC 1, DISC 2, DISC 3, DISC 4** or **DISC 5** on the main unit or **DISC SKIP** on the remote control to skip discs.

Searching Through a CD

- Press **SKIP BACKWARD** $\blacktriangleleft\blacktriangleleft$ / **SKIP FORWARD** $\blacktriangleright\blacktriangleright$ to skip to the previous or next track.
- Press and hold **SKIP BACKWARD** $\blacktriangleleft\blacktriangleleft$ / **SKIP FORWARD** $\blacktriangleright\blacktriangleright$ to search through a CD while it is playing.

Sampling Tracks

Press **INTRO** on the remote control to play the first 10 seconds of each track on the current disc, all discs in the tray, or turn intro mode off. INTRO is displayed when sampling is activated.



Tips:

Random playback can be activated simultaneously with repeat 1 disc (randomly play tracks from one disc repeatedly) or repeat all discs (randomly play tracks from all discs repeatedly).

USB and Memory Card

EN

Connecting USB device to the Audio System

1. Uncover the USB connector on the top of the unit.
2. Insert the USB plug of the USB device to the USB connector.

Inserting Memory Card

Insert a SD card into the MEMORY CARD slot on the unit.

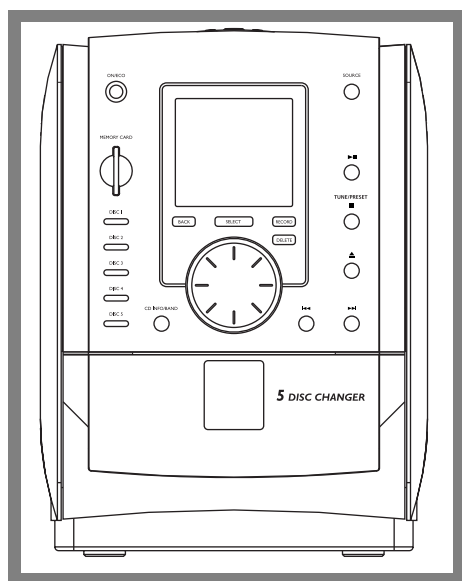

Selecting USB or Memory Card Mode

Press **SOURCE** repeatedly to select USB or Memory Card mode.

USB and Memory Card

EN

USB / Memory Card Playback Features

Start and Pause Playback

Press **PLAY / PAUSE** ►|| to start and pause playback.

Stop Playback

Press **STOP** ■ to stop playback operations. The unit enters navigation mode for 10 seconds before entering stop mode.

Stop Mode

MP3/WMA
10 Tracks

Navigation Mode

- ROOT
 RECORD
 Song 1



Tips:

In stop mode, press **UP** ▲, **DOWN** ▼ or **RIGHT / ENTER** ► to enter navigation mode and show file menu.

In navigation mode, press **LEFT / BACK** ◀ to return to stop mode.

Skipping Files

- Press **SKIP BACKWARD** ◀◀ / **SKIP FORWARD** ▶▶ to skip to the previous or next file.
- Press and hold **SKIP BACKWARD** ◀◀ / **SKIP FORWARD** ▶▶ to search through a file while it is playing.

Sampling Files

Press **INTRO** on the remote control to play the first 10 seconds of each file. INTRO is displayed when sampling is activated.

Repeat

Press **REPEAT** on the remote control to toggle repeat options: Repeat the current file (REPEAT 1), Repeat all files (REPEAT ALL), or Normal playback.

Random Playback

Press on the remote control to turn on/off random playback. The SHUFFLE icon is displayed when it is activated.

Memory Usage

Press **CD INFO** to view memory usage on the USB device or SD card.

Mem Usage
141M Used
115M Free

Program

EN

Setting Up Program



Tips:

You can create playback program of up to 32 tracks from CD, USB and Memory Card mode.

1. In navigation mode, use the navigation buttons to select the track / file to add to program playlist (Refer to "Navigation Controls").
2. Press **ADD** to save the selected track into the next available program location.
3. Repeat steps 1 to 2 to store more tracks into program.

Add to
Prog 02



Tips:

In stop mode, press **UP** Δ , **DOWN** ∇ or **RIGHT** / **ENTER** \triangleright to enter navigation mode and show disc/file menu.

Playing Program

While in stop mode, press **PROG** to enter PROGRAM mode. Press **PLAY/PAUSE** $\blacktriangleright \parallel$ to start playback.

Display Program List

1. While in stop mode, press **PROG** to enter PROGRAM mode.

Prog 01
DISC 01
Audio 03

2. Press **UP** Δ / **DOWN** ∇ repeatedly to view each track assignment in the program list.

Remove Track / File from Program

1. In navigation mode, use the navigation buttons to select the track / file to delete from Program.
2. Press **DEL**.
3. Press **UP** Δ / **DOWN** ∇ to select between No and Yes.
4. Press **RIGHT** / **ENTER** \triangleright to confirm selection.

Remove the Entire Program

1. While in PROGRAM mode, press and hold **DEL**.
2. Press **UP** Δ / **DOWN** ∇ to select between No and Yes.
3. Press **RIGHT** / **ENTER** \triangleright to confirm selection.

Radio

EN

Selecting Tuner Band

1. Press **SOURCE** to enter Tuner mode.
2. Press **BAND** to select between FM or AM Radio band.



Tips:

Your audio system has 32 preset stations.

automatic upon pressing the button. You can stop the automatic scan by pressing any button, but the erased stations cannot be recovered.

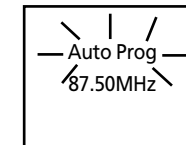

Tuning to a Station

Press **SKIP BACKWARD** $\blacktriangleleft\blacktriangleleft$ or **SKIP FORWARD** $\blacktriangleright\blacktriangleright$ to select frequencies.

Using Presets

The tuner can be in either TUNE or PRESET mode.

- Press **STOP** \blacksquare to toggle TUNE and PRESET mode.
- Press **SKIP BACKWARD** $\blacktriangleleft\blacktriangleleft$ or **SKIP FORWARD** $\blacktriangleright\blacktriangleright$ to access the previous or next preset station.

Preset 01
87.50MHz

Manually Setting Presets

1. Press the **STOP** \blacksquare button to enter TUNE mode.
2. Press **SKIP BACKWARD** $\blacktriangleleft\blacktriangleleft$ or **SKIP FORWARD** $\blacktriangleright\blacktriangleright$ to access the desired frequency.
3. Press the **PROG** button once and the most recently accessed program location flashes on the display.

Preset 2
90.50MHz

5. If a different program location is preferred, press **SKIP BACKWARD** $\blacktriangleleft\blacktriangleleft$ or **SKIP FORWARD** $\blacktriangleright\blacktriangleright$ to move to the desired preset number (1-32).
6. Press **PROG** to store the selected frequency at that preset.

Suppressing Stereo Signal

Press **FM ST** to toggle between FM mono and stereo mode. (Remote Only) "STEREO" is displayed in stereo mode.

Radio

EN

Tuning to an RDS Station



Note:

RDS stations broadcast on FM only. When the tuner detects an RDS signal, the RDS icons turn on.

1. Press **SKIP BACKWARD** **◀◀** or **SKIP FORWARD** **▶▶** to go to your desired frequency.
2. If a RDS station found, RDS lights on display with station name shown.

Displaying RDS Station Information

Press **REPEAT•RDS** on the remote control repeatedly to display the following:

- frequency,
- station name (PS),
- station type (PTY),
- clock time (CT), or
- radio text (RT).

In CT mode, press the **INTRO•CT** key to replace the displayed time with RDS station time.

Searching by Program Type (PTY) (Remote Only)

1. Press **• PTY** to enter PTY selection
2. Press **• PTY** repeatedly to select a PTY mode.
3. Within 5 seconds, press **SKIP BACKWARD** **◀◀** or **SKIP FORWARD** **▶▶** to search for a station broadcasting the selected type of program.

You can search for stations using one of the following program types:

- NEWS (news),
- AFFAIR (news and documentaries),
- INFO (weather, medical),
- SPORT (sports),
- EDUCAT (education),
- DRAMA (series and plays),
- CULTUR (religion),
- SCIENC (science and technology),
- VARIED (miscellaneous),
- POP M (pop music),
- ROCK M (rock music),
- MOR M (middle-of-the road music),
- LIGHTM (light music),
- CLASS (classical music),
- OTHERM (unclassified music),
- WEATHE (weather, medical),
- FINANC (stock market reports),
- CHILD (children's programs),
- SOCIAL (sociology, history, geography, psychology, society),
- RELIGI (any aspect of beliefs, faith and God or Gods),
- PHONE (public forum b phone),
- TRAVEL (feature and programs concerning travelling),
- HOBBY (recreational activities and leisure),
- JAZZ (jazz music),
- COUNTR (country music),
- NATION (national music),
- OLDIES (oldies music),
- FOLK M (folk music),
- DOCUME (documentaries),
- TEST,
- ALARM (alarm).

Recording

You can record CD, Tuner or AUX files to USB device (e.g. mp3 player).

Recording CD to USB Device

Recording Standby

1. Connect the USB device to the USB port, "USB Connected" will show on the display.
2. In CD stop mode, CD navigation mode or CD pause mode, press **RECORD** to enter recording standby. The RECORD icon flashes on the display.
3. Press **PLAY / PAUSE** to start playing the CD. Recording will start automatically. The RECORD icon lights on the display.

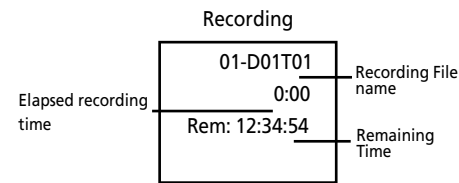

Example (Record one CD):

1. Press **RECORD** to enter recording standby, then press **DISC 1** to **DISC 5** to record the corresponding disc.

Example (Record all 5 CDs):

1. Press **RECORD** to enter recording standby, then press **PLAY/PAUSE** to start recording (Make sure "All Disc" mode is selected)

Example:

1. Create a CD program by following instructions under "Setting Up a CD Program" on page 15.
2. In CD stop mode or navigation mode, press **RECORD** to enter recording standby. The RECORD icon flashes on the display.
3. From normal playback mode, press **PROG** to enter program play mode. Playback and recording begins automatically. The PROGRAM and RECORD icons light on the display.
4. Press **STOP** to stop recording.

EN

Instant Recording

1. In CD playback mode, press **RECORD** to start recording. The RECORD icon lights on the display.

In CD playback mode

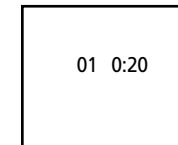

Recording

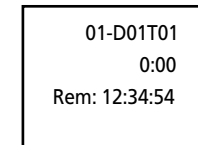

Example:

1. Start CD program playback. From normal playback mode, press **PROG** to enter program playback mode.
2. Press **PLAY / PAUSE** to begin program playback.
3. Press **RECORD** to begin recording instantly.
4. Press **STOP** to stop recording.

Recording

EN

Recording Tuner / AUX to USB Device

1. In Tuner or AUX mode, press **RECORD** to start recording.
The RECORD icon lights on the display.

Example:

1. In radio mode, select the station to record (refer to page 19 for details).
2. Press **RECORD** to start recording.
3. Press **STOP** to stop recording.

In Tuner mode

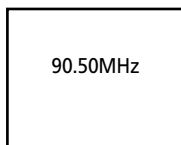

Recording

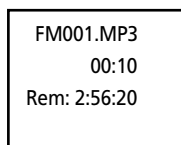

Note:

The encoding bitrate for tuner, CD and AUX signal are as below:
CD / Aux : 128 kbps
Tuner : 96 kbps

Deleting Files from USB Device or Memory Card

1. In navigation mode, select the file to delete using the navigation buttons (Refer to "Navigation Controls" for details.)

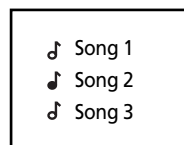

2. Press **DELETE** on the main unit or **DEL** on the remote control.
3. Rotate the Volume button on the main unit or press **UP** Δ or **DOWN** ∇ on the remote control to select Yes to delete or No to cancel.

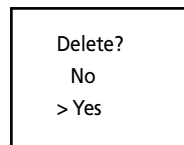

4. Press **SELECT** on the main unit or **RIGHT / ENTER** \blacktriangleright on the remote control to confirm selection.
If Yes is selected, the display shows memory usage information after deleting selected file for a few seconds, then returns to navigation menu.

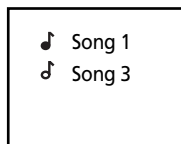
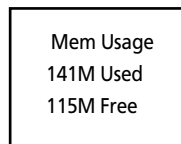

Deleting All Files

In navigation mode, press and hold **DELETE** on the main unit or **DEL** on the remote control to delete all the files on the USB device.

Troubleshooting Tips

Main Unit

EN

Problem	Solution	Problem	Solution
<i>System will not turn on</i>	<ul style="list-style-type: none"> • Check power cord for a secure connection. • Unplug the unit for a moment, and then plug into power source again. • Check the outlet by plugging in another device. 	<i>CD sound skips</i>	<ul style="list-style-type: none"> • Clean the disc. • Check disc for warping, scratches, or other damage. • Check if something is causing the system to vibrate. If so, move the system. • Make sure the speakers are at least 3 feet away or on a different surface from the main unit.
<i>No sound</i>	<ul style="list-style-type: none"> • Increase the volume setting. • Check connection to speakers. • Check that you have selected the appropriate function: CD, Tuner. • Make sure mute is off. • Make sure headphones are not plugged in. 	<i>CD button will not respond, or does not change discs when you press DISC SKIP</i>	<ul style="list-style-type: none"> • Switch to another function (Tuner) and then back to CD.
<i>Poor radio reception</i>	<ul style="list-style-type: none"> • Check antenna connection. • Move antenna. • Turn off nearby electrical appliances, such as hair dryer, vacuum cleaner, microwave, fluorescent lights. 	<i>Remote control does not work</i>	<ul style="list-style-type: none"> • Check that the batteries are properly installed. • Replace weak batteries. • Check the system is plugged into power source. • Point the remote directly at the system's front panel. • Move closer to the system. • Remove any obstacles between the remote and the system.
<i>CD does not play</i>	<ul style="list-style-type: none"> • Check that CD is in the tray. • Check that CD label is facing up. • Check that PAUSE mode is not on. • Check that CD function is selected. • Use CD lens cleaner. • Clean the disc. • Try another CD. 		

Troubleshooting Tips

EN

Problem Solution

mp3/WMA playback sequence is out of order

- Check that the mp3/WMA disc is created with a single folder structure. Refer to the diagram below for playback sequence details on multi-level folder structure.
- For example, folders and songs from level 2 are played before moving on to play folders and songs from level 3.

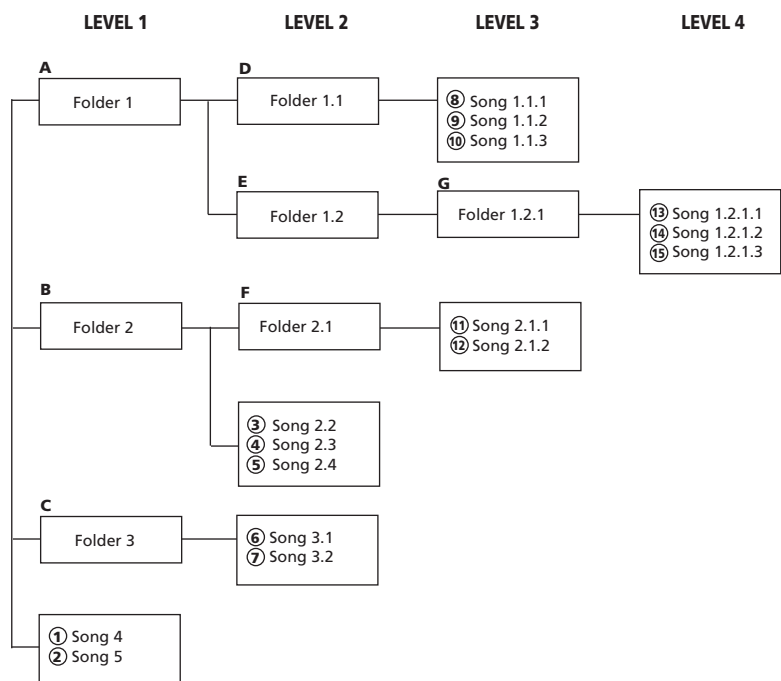

Note:

- Folder playback sequence is indicated by the letters A to G.
- Song playback sequence is indicated by the numbers (1 to 15) in front of the song name.

Maintenance

Disconnect the audio system from the power source before performing any maintenance.

Cleaning

Clean the exterior of the system using a soft dust cloth.

CD Player

CAUTION! This system operates with a laser. It must be opened by only a qualified technician.

Handling CDs

- Do not touch the signal surfaces. Hold CDs by the edges, or by one edge and the hole.
- Do not affix labels or adhesive tapes to the label surfaces.
- Do not scratch or damage the label. CDs rotate at high speeds inside the player.
- Do not use damaged (cracked or warped) CDs

Cleaning CDs

- Dirty CDs can cause poor sound quality. Always keep CDs clean by wiping them gently with a soft cloth from the inner edge toward the outer perimeter.
- If a CD becomes dirty, wet a soft cloth in water, wring it out well, wipe the dirt away gently, and then remove any water drops with a dry cloth.
- Do not use record cleaning sprays or antistatic agents on CDs. Also, never clean CDs with benzene, thinner, or other volatile solvents which may cause damage to disc surface

CD Lens Care

When your CD lens gets dirty it can also cause the system to output poor sound quality. To clean the lens you will need to purchase a CD lens cleaner which can maintain the output sound quality of your system. For instructions on cleaning the CD lens, refer to the ones accompanying the lens cleaner.

Technical Specification

Power supply: 230V~50Hz

Dimensions (H x W x D inches):

Unit size - 11 x 7.3 x 12

Speaker - 11.5 x 7.8 x 8.6

CD player: Response curve (+/- 2dB): 60Hz to 5kHz

Rating Plate: Look for it at the back of the set.

Maximum size of Mass Storage Class device supported: 20 GB

Supported SD card memory size: 32 / 64 / 128 / 256 / 512 / 1024 MB

Supported MMC card memory size: 32 / 64 / 128 MB

EN

Free Manuals Download Website

<http://myh66.com>

<http://usermanuals.us>

<http://www.somanuals.com>

<http://www.4manuals.cc>

<http://www.manual-lib.com>

<http://www.404manual.com>

<http://www.luxmanual.com>

<http://aubethermostatmanual.com>

Golf course search by state

<http://golfingnear.com>

Email search by domain

<http://emailbydomain.com>

Auto manuals search

<http://auto.somanuals.com>

TV manuals search

<http://tv.somanuals.com>