

THOMSON

u s e r m a n u a l

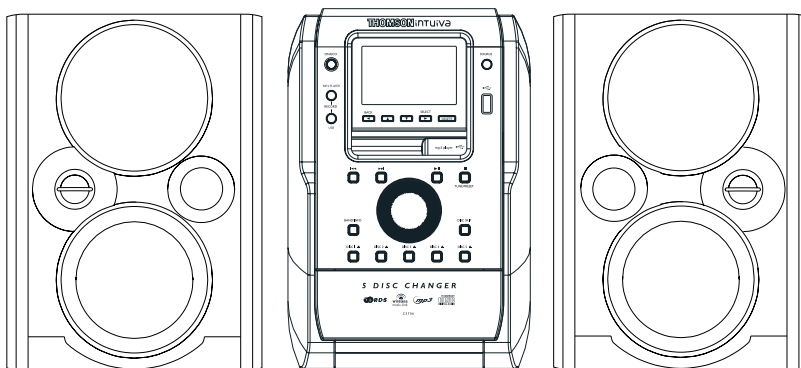

CS806

It is important to read this instruction book prior to using your new product for the first time.

Safety Information

For UK Only

EN

CONNECT THE MAIN LEAD INTO A MAINS POWER SOCKET

POWER SUPPLY **230V**. It must not be connected to D.C. mains.

Note: The mains lead of the set is fitted with a molded plug. If the mains socket are not compatible or if for any reason the plug is removed please follow the directions below. The molded plug cannot be rewired and if removed must be disposed of safely.

DO NOT under any circumstances plug the severed plug into any mains socket as this could result in electric shock.

Important: If the plug is removed, rewire the new plug as follow:
The wires in the mains plug are colored in accordance to the following code:

BLUE = NEUTRAL / BROWN = LIVE

If the colors of the wires in the mains lead of this apparatus may not correspond with the colored markings identifying the terminals in your plug, proceed as follows:



BLUE wire to the terminal coded N (Neutral) or colored black.

BROWN wire to the terminal coded L (Live) or colored red.

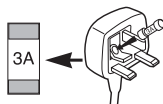
DO NOT make any connection to the terminal in the plug which is marked by the letter E or by the earth symbol or colored green or green and yellow.



A fused plug must be fitted with a 3A fuse approved by ASTA or BS1362 and fuse covers must be always be securely replaced. If you set does not work, the fuse may be blown.

	CAUTION RISK OF ELECTRIC SHOCK DO NOT OPEN	
THE LIGHTNING FLASH AND ARROW-HEAD WITHIN THE TRIANGLE IS A WARNING SIGN ALERTING YOU OF "DANGEROUS VOLTAGE" INSIDE THE PRODUCT.	CAUTION: TO REDUCE THE RISK OF ELECTRIC SHOCK, DO NOT REMOVE COVER (OR BACK). NO USER-SERVICEABLE PARTS INSIDE. REFER SERVICING TO QUALIFIED SERVICE PERSONNEL.	THE EXCLAMATION POINT WITHIN THE TRIANGLE IS A WARNING SIGN ALERTING YOU OF IMPORTANT INSTRUCTIONS ACCOMPANYING THE PRODUCT.
SEE MARKING ON BOTTOM / BACK OF PRODUCT		

WARNING: TO PREVENT FIRE OR ELECTRICAL SHOCK HAZARD, DO NOT EXPOSE THIS PRODUCT TO RAIN OR MOISTURE.

Safety Information

CAUTION!

Invisible laser radiation when open. Avoid exposure to beam. Class 1 laser product. This system must be opened only by qualified technicians to prevent accidents caused by the laser beam.

LASER $\lambda = 780 \text{ nm}$, P max = 5 mW
 Rating Information: At bottom/rear of the unit.
 This unit comply with the existing requirements



In accordance with the rating plate of the unit, this unit complies with current standards concerning electrical safety and electromagnetic compatibility.



Please respect the environment
 Before throwing any batteries away, consult your distributor who may be able to take them back for specific recycling.



Have a Blast- Just Not in Your Eardrums
 Make sure you turn down the volume on the unit before you put on headphones. Increase the volume to the desired level only after headphone are in place.

Main plug is used as the disconnect device, it shall remain readily operable and should not be obstructed during intended used. To be completely disconnected the apparatus from supply mains, the main plug of the apparatus shall be disconnected from the mains socket outlet completely.

Portions based upon Microsoft Windows Media Technologies. Copyright © 1999 Microsoft Corporation. All Rights Reserved. Microsoft, Windows Media, and the Windows Logo are trademarks or registered trademarks of Microsoft Corporation in the United States and/or other countries.

The descriptions and characteristics given in this document are given as a general indication and not as a guarantee. In order to provide the highest quality product possible, we reserve the right to make any improvement or modification without prior notice. The English version serves as the final reference on all products and operational details should any discrepancies arise in other languages.

ADVARSEL!
 USYNLIG LASERSTRÅLING VED ÅBNING NÅR SIKKERHEDSAFBRYDERE ER UDE AF FUNKTION. UNGDÅ UDSÆTTELSE FOR STRÅLING.
 VORSICHT!
 UNSICHTBARE LASERSTRALUNG WENN ABDECKUNG GEÖFFNET UND SICHERHEITVERRIEGELUNG ÜBERBRÜCKT.
 NICHT DEM LASERSTRAHL AUSSETZEN!

CAUTION – INVISIBLE LASER RADIATION WHEN OPEN AND INTERLOCKS FAILED OR DEFEATED. AVOID EXPOSURE TO BEAM.
 ATTENTION – RAYONNEMENT LASER INVISIBLE DANGEREUX EN CAS D'OUVERTURE ET LORSQUE LA SECURITE EST NEUTRALISEE.
 EXPOSITION DANGEREUSE AU FAISCEAU.



CLASS 1 LASER PRODUCT
 LASER KLASSE 1
 APPAREIL A LASER DE CLASSE 1
 LUOKAN 1 LASERLAITE
 KLASSE 1 LASERAPPARAT

WARNING – OSYNLIG LASERSTRÅLING NÅR DENNA DEL ÅR ÖPPNAD OCH SPÄRRAN ÅR URKOPPLADE. BETRakta EJ STRÅLEN.
 VARO!
 AVÄRTAESSA JA SOUJALUKITUSOHITETTAESSA OLET ALLTIINA NÄKYMÄTTÖMÄLLE.
 LASERSÄTEILYLLE ÄLÄ KATSO SÄTEESEEN.

EN

Important Information

EN

Safety Precautions

- Never open the cabinet under any circumstances. Any repairs or internal adjustments should be made only by a trained technician.
- Never operate this product with the cabinet removed.
- Do not use your System immediately after transporting it from a cold place to a warm place, as condensation may cause the system to malfunction.
- Keep your unit away from humid areas and abnormally hot places.
- Do not touch the player with wet hands. If any liquid enters the player cabinet, take the player to a trained technician for inspection.
- This compact disc player uses a laser to read the music on the disc. The laser mechanism corresponds to the cartridge and stylus of a record player. Although this product incorporates a laser pick-up lens, it is completely safe when operated according to directions.
- Discs rotate at high speed inside the player. Do not use damaged, warped, or cracked discs.
- Do not touch the pick-up lens which is located inside the disc compartment. To keep dust from collecting on the pick-up lens, do not leave the compartment door open for an extended period of time. If the lens becomes dirty, clean it with a soft brush, or use an air blower brush designed for camera lenses.
- The apparatus shall not be exposed to dripping or splashing and that no objects filled with liquids, such as vases, shall be placed on the apparatus.
- Minimum distances around the apparatus for sufficient ventilation .
- The ventilation should not be impeded by covering the ventilation opening with items, such as newspaper, table-cloths, curtains, etc.
- No naked flame sources, such as lighted candles, should be placed on the apparatus.
- Attention should be drawn to the environmental aspects of battery disposal .

Important Battery Information

- Remove the batteries to avoid leakage if you do not use your remote control for more than one month.
- Discard leaky batteries immediately as leaking batteries may cause skin burns or other personal injuries. Dispose of batteries in the proper manner, according to provincial and local regulations.
- Any battery may leak electrolyte under the following circumstances:
 - if mixed with a different battery type,
 - if inserted incorrectly,
 - if all batteries are not replaced at the same time,
 - if disposed of in fire, or
 - if an attempt is made to charge a battery not intended to be recharged.

Precautions for the mp3 Player

- Do not use the unit immediately after transportation from a cold place to a warm place; condensation problem may result.
- Do not store the unit near fire, places with high temperature or in direct sunlight.
- Do not operate or store unit in places with frequent static electricity or electrical noise (e.g. speaker, TV set).
- Clean the unit with a soft cloth or a damp chamois leather. Never use solvents.
- The unit must only be opened by qualified personnel.



Note:

This unit may temporarily cease to function if subjected to electrostatic disturbance. To resume normal operation, it may be necessary to cycle the power off and back on or to remove and reinstall the batteries.

Important Information

Headset Safety

- Do not play your headset at high volume. Hearing experts warn against extended high-volume play.
- If you experience ringing in your ears, reduce volume or discontinue use.
- You should use with extreme caution or temporarily discontinue use in potentially hazardous situations. Even if your headset is an open-air designed to let you to hear outside sounds, do not turn up the volume so high that you are unable to hear what is around you.

Caution While Driving

Use of headphones while operating an automobile or moving vehicle is not recommended and is unlawful in some states and areas. Be careful and attentive on the road. Stop operation of the unit if you find it disruptive or distracting while driving.

Don't Infringe

This product should only be used for the purposes for which it is sold, that is, entertainment, violating no copyright law. Any attempts to use this product for which it is not intended is unlawful and therefore not condoned by Thomson.



This symbol means that your inoperative electronic appliance must be collected separately and not mixed with the household waste. The European Union has implemented a specific collection and recycling system for which manufacturers are responsible. This appliance has been designed and manufactured with high quality materials and components that can be recycled and reused. Electrical and electronic appliances are liable to contain parts that are necessary in order for the system to work properly but which can become a health and environmental hazard if they are not handled or disposed of in the proper way. Consequently, please do not throw out your inoperative appliance with the household waste. If you are the owner of the appliance, you must deposit it at the appropriate local collection point or leave it with the vendor when buying a new appliance.

- If you are a professional user, please follow your supplier's instructions.
 - If the appliance is rented to you or left in your care, please contact your service provider.
- Help us protect the environment in which we live!

EN

Table of Contents

EN

Safety Information	
Important Information	
Table of Contents	1
Getting Started	2
Content of Box	2
Connections of Antennas, Speakers and Microphone	2
PC Software Installation	3
General Controls	4
Main Unit	4
Music Navigator Remote	5
Display	6
Settings	7
Setting the Clock and Timer	7
Program Recording	7
Sleep Mode	7
Sound Features	8
Volume Control	8
Bass Boost and Equalizer	8
CD and mp3 Disc Playback	8
Loading Discs	9
Play/Pause/Stop Discs	9
Skipping/Scanning Tracks	9
USB and mp3 Player Playback	10
Connecting/Disconnecting USB device to the Main Unit	10
Connecting/Disconnecting mp3 Player to the Main Unit	10
Selecting USB or Portable Player Mode	10
USB/mp3 player Playback Features	10
Memory Usage	10
Radio	11
Selecting Tuner Band	11
Tuning to a Station	11
Using Presets	11
Auto Preset Programming	11
Manually Setting Presets	11
Microphone Input	12
Connecting your Microphone	12
Adjusting Volume	12
Singing or Speaking with your Microphone	12
Microphone Input Recording	12
Recording to the mp3 Player/ USB device	13
Recording CD to mp3 player	13
Recording Tuner/AUX to mp3 Player	14
Program Recording	14
Recording with Microphone Input	14
Recording to USB Device	14
Recording Information	14
Deleting files from mp3 Player/USB device	14
Wireless Musiclink	15
Connecting your Unit to the Computer	15
Playing Music via Wireless Music Link Transceiver	15
Playback Features	15
Advanced Playback Controls	16
Intro/Repeat/Random	16
Setting Up a Program List	16
Rename Tracks	16
Advanced Navigation Controls	17
File Navigation	17
Main Unit	17
Music Navigator Remote	17
Display	18
Tips on Playback Sequence of Disc	19
mp3 Player	20
Insert battery into the Player	20
General Controls	20
Display Overview	20
Playback Features	20
Check for Updates	21
Frequently Asked Questions	21
Troubleshooting Tips	22
Main Unit	22
mp3 Player	23
Maintenance	24
Cleaning	24
Handling CDs	24
CD Lens Care	24
Technical Specification	24

Getting Started

Content of Box

- one main unit (with 2 main speakers);
- one Music Navigator Remote control*;
- one FM antenna;
- one MW loop antennas;
- one USB cable;
- one Wireless Musiclink transceiver;
- one mp3 player;
- one set of earphones;
- one user manual;
- one PC software and driver installation CD-ROM;
- one safety leaflet;
- Owner registration Card.



Note*:

- The remote control is inserted in the front polyfoam of the package. Make sure you take the remote control out of the polyfoam before you throw it away.
- Make sure the tracks are encoded in mp3 or Windows Media formats and supported bitrates. Bitrates supported by the player: mp3 – 32 to 320kbps wma – 48 to 160kbps

Warning:

Use of this product is for your personal use only. Unauthorized recording or duplication of copyrighted material may infringe upon the rights of third parties and may be contrary to copyright laws.

Using the FM and MW Antennas

Before you use your audio system, you'll want to make sure both the FM and MW antennas are positioned properly. Uncoil the FM antenna at the back of the unit, making sure it is fully extended (you may even want to tape it to the wall behind the unit if possible. The higher the better.) You'll also need to connect the MW antenna loop to the back of the unit if you listen to MW stations. Rotate the MW loop antenna for better reception.

EN

Connecting the Speakers

Each speaker has a black (negative) and a red (positive) jack. When connecting the speakers, match the red wires to the red jacks and the black wires to the black jacks.

Speaker Wire Connection

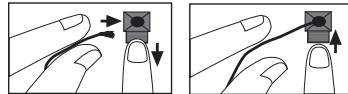

Push Speaker terminal tab down to insert wire.

Release tab to lock wire in the terminal.

NOTE: Make sure the insulation is completely removed from the ends of the speaker wires at all connection points.

Installation

To ensure sufficient ventilation, keep the spacings shown below free from other surfaces:

Connections of Antennas, Speakers and Microphone

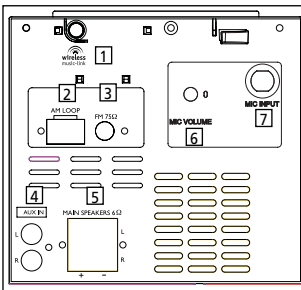

1. Wireless Music-link antenna.
2. MW Loop antenna Jacks.
3. FM Antenna Jack.
4. AUX IN.
5. Main Speaker Jacks.
6. MIC VOLUME.
7. MIC INPUT Connector.

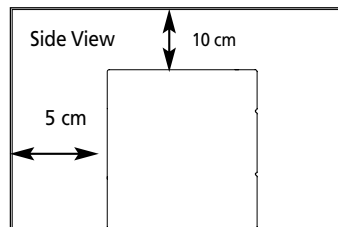
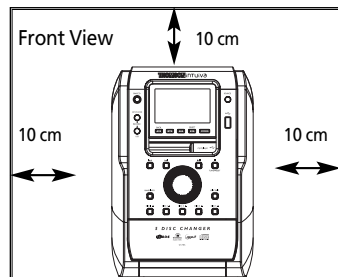

Getting Started

EN

PC Software Installation

Before you can have remote access to the Windows Media Player Library in your computer via the Wireless Musiclink, you need to install the following software and driver.

Computer system requirements

- Pentium III 500MHz or higher recommended
- Windows® 2000 (SP6 or higher) or XP
- Windows Media Player 9 or higher
- Internet access
- 200MB free hard disk space for the software
- 128MB RAM or above
- USB port (2.0 recommended)

Install Windows Media Player



Tips:

You can skip this section and continue with **Install the Wireless Musiclink Driver** if your computer has installed Windows Media Player 9 or higher.

1. Turn on your computer and place the install CD that came with your unit into your computer.
2. Click My Computer, double click your CD-ROM drive icon, and double click *CD installer* to run the installer. 
3. Click *Download Microsoft Windows Media Player*.

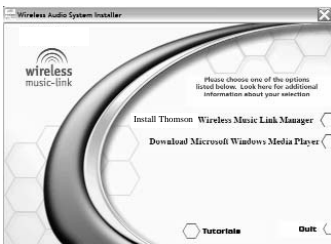

4. A new browser will pop up with the page for selecting different version of Windows Media Player. Download Windows Media Player 9 or above and follow the on-screen instruction to install the software.

Install the Wireless Musiclink Driver

1. Click *Install Thomson Wireless Music Link Manager*.

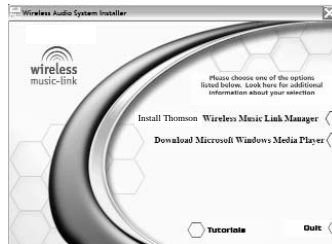

2. Follow the on-screen instruction to install the driver.



Tips:

You can click *Tutorials* in the installation screen to obtain more information.

Tutorials

General Controls

Main Unit

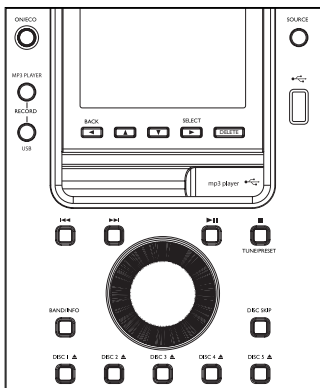

ON/ECO

- Press briefly to turn on and off the unit.
- Press and hold in standby mode to enter ECO (power saving, without clock display) mode. The blue standby indicator lights around the button.



Tips:

In **STANDBY** mode, press **ON/ECO** to turn the system on in the previously used mode. Press **SOURCE** to select the corresponding mode. Look at the display icons to identify the current mode.

SOURCE - Selects among CD player, TUNER, PC, PORTABLE PLAYER, USB and AUX.

RECORD-MP3 PLAYER - Starts and stops recording to mp3 player.

RECORD-USB - Starts and stops recording to USB device.



- *In CD, Portable Player, USB or MP3/WMA mode* - Goes to the previous/next track; searches backwards/forwards through track.
- *In Tuner mode* - Tunes down/up frequency.
- *In Clock or Timer mode* - Decreases/increases hour and minute digit.

▶▶ - *In CD, Portable Player, USB or MP3/WMA mode* - Starts and pauses playback.

■ TUNE/PRESET

- *In CD, Portable Player, USB or MP3/WMA mode* - Stops playback; displays the total number of folders and total number of tracks on the current disc when playback is completely stopped.
- *In Recording mode* - Stops recording to USB device.
- *In Tuner mode* - Selects tune or preset mode.

BAND/INFO

- *In CD, USB or MP3/WMA mode* - Cycles the display to show various information (e.g. Track time, remaining time, ID3 tag, etc.)
- *In Portable Player or USB mode* - Shows memory usage.
- *In Tuner mode* - Selects radio band.

DISC SKIP - Skips to the next disc in CD mode.

DISC 1 ▲ / DISC 2 ▲ / DISC 3 ▲ / DISC 4 ▲ / DISC 5 ▲

- Opens or closes the corresponding disc tray if no disc is loaded in the corresponding tray.
- Enters CD mode and plays the corresponding CD when disc is loaded in the corresponding tray.

VOLUME CONTROL

- Adjusts volume.
- *In navigation mode* - Selects items on a list.

Navigation Buttons

Use the navigation buttons to navigate through menu.

DELETE - Deletes the selected item.

▶ SELECT

- *From stop mode* - Enters navigation mode.
- *In navigation mode* - Plays selected track or enters selected folder.

◀ BACK - *In navigation mode* - Exits current folder and returns to higher level.



- *In navigation mode* - Moves up/down a list.
- *In Tuner mode* - Selects the previous/next preset station.

DEMO (on top of the unit) - Turn on/off demonstration.

EN

General Controls

Music Navigator Remote

The LCD of the remote mirrors the screen of the main unit.

EN

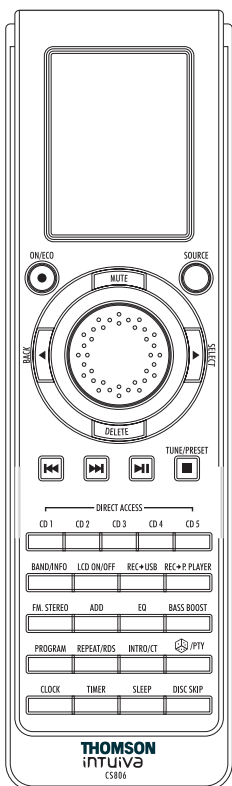

ON/ECO - Turns power on or off (STANDBY mode).

SOURCE - Selects among CD player, TUNER, PC, PORTABLE PLAYER, USB and AUX.

MUTE - Mutes audio output.

VOLUME CONTROL - Adjusts volume.
In navigation mode - Rotate clockwise to navigate downwards and rotate counter-clockwise to navigate upwards.

◀◀ / ▶▶

- *In CD, Portable Player, USB or MP3/WMA mode* - Goes to the previous/next track; searches backward/forward through track.
- *In Tuner mode* - Tunes down/up radio frequency.
- *In Clock or Timer mode* - Decreases/increases hour and minute digit.

▶|| (**PLAY/PAUSE**) - *In CD, Portable Player, USB or MP3/WMA mode* - Starts and pauses playback.

■ TUNE/PRESET

- *In CD, Portable Player, USB or MP3/WMA mode* - Stops playback; displays the total number of total number of tracks on the current disc when playback is completely stopped.
- *In Recording mode* - Stops record to USB device;
- *In Tuner mode* - Selects tune or preset mode.

CD 1/CD 2/CD 3/CD 4/CD 5 - Plays the corresponding disc.

BAND/INFO

- *In Tuner mode* - Selects radio band.
- *In CD, USB or MP3/WMA mode* - Cycles display to show various information. (e.g. track time, remaining time, ID3 tag, etc.)
- *In Portable Player or USB mode* - Shows memory usage.

LCD ON/OFF - Turns LCD on or off.

REC ▶ USB - Starts and stops recording to USB device.

REC ▶ P. PLAYER - Starts and stops recording to mp3 player.

FM STEREO - Selects between stereo and mono sound in FM tuner mode.

EQ - Selects equalizer presets.

BASS BOOST - Turns on or off Bass Boost.

PROGRAM - *In CD, Portable Player or USB and Tuner mode* - Enters program mode.

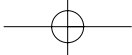

General Controls

REPEAT/RDS - In CD mode - Repeats a track, CD or all CDs.
 In Portable Player, USB or MP3/WMA mode - Selects repeat one file, repeat all files mode.
 In Tuner mode - Shows RDS information.

INTRO/CT - In CD, Portable Player, USB or MP3/WMA mode - Turns intro mode on or off to play the first 10 seconds of each track / file.
 In CT mode - Replaces the displayed time with RDS station time.

JPTY - In CD, Portable Player, USB or MP3/WMA mode - Turns on/off random playback.
 In Tuner mode - Searches radio band by program type.

CLOCK - Displays clock time. Press and hold to enter clock setting mode.

TIMER - Enters timer setting mode.
 Activates and deactivates timer.

SLEEP - Selects the time interval in minutes before the unit turns off.

DISC SKIP - Skips to the next disc in CD mode.

Navigation Buttons

Use **VOLUME CONTROL** dial to select items.

ADD - Adds the selected item.

DELETE - Deletes the selected item.

BACK - In navigation mode - Exits current folder and returns to higher level; exits navigation mode after returning to top layer.

SELECT

- From stop mode - Enters navigation mode.
- In navigation mode - Plays selected track or enter selected folder.

EN

Installing Batteries

The remote control must be inserted with 3 "AAA" or "UM-4" or "R03" batteries prior to use.

Display

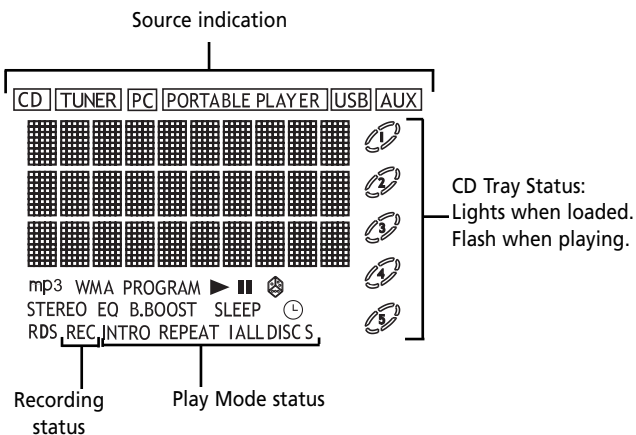

Settings

EN

Showing Demonstration

Press **DEMO** to turn on/off demonstration mode.

Setting the Clock

1. Press and hold **CLOCK** on the remote control until the hour flashes on the display.
2. Press **◀◀** or **▶▶** to set the hour and then press **CLOCK** to shift to minute digits.
3. Press **◀◀** or **▶▶** to set the minute.
4. Press **CLOCK** twice to save and quit settings.



Note:

When system is ON, you can press **CLOCK** to display the current time for about 2 seconds.

Setting the Timer

You can turn on/off the unit or record TUNER at preset times by setting the timer.

1. Press and hold **TIMER** on the remote control until Timer On and the clock hour flashes on the display.
2. For setting time, press **◀◀** or **▶▶** to set the hour and then press **TIMER** to shift to minute digits.
3. Press **◀◀** or **▶▶** to set the minute.
4. Press **TIMER** to change to Timer Off setting with clock time flashing. Press **TIMER** to select source. Press **◀◀** or **▶▶** to select Player/Tuner/Rec Tuner/CD/USB.
If Rec Tuner is selected, press **◀◀** or **▶▶** to select the preset station.
5. Press **TIMER**. Adjust **VOLUME CONTROL** to set volume.
6. Press **TIMER** to save and quit setting. The timer is automatically activated once timer setting is saved.

Activating the Timer

Press and release **TIMER** to turn on/off the alarm.

Ⓢ is displayed when timer is activated.

Program Recording

When setting the Timer, select "Rec Tuner" as the source to preset the unit to record radio at the preset time. Make sure the USB device is connected and have enough memory space.



Tips:

"Rec Tuner" setting is for Program Recording. For more information, see paragraph below.

Sleep Mode

You can select the time interval before the unit turns off automatically.

Press **SLEEP** to select among OFF, 120, 90, 60, 45, 30, 15 and 5 minutes.

SLEEP is displayed when sleep mode is activated.

Viewing Remaining Sleep Time

When sleep is activated, press **SLEEP** once to view remaining sleep time.

Adjusting Sleep Time

Press **SLEEP** again when the remaining sleep time is displayed to change sleep time.



Note:

Sleep is automatically de-activated when the unit is turned off.

Sound Features

Volume Control

Rotate the volume control on the main unit or on the remote control to adjust volume level.

Bass Boost

Press **B.BOOST** to turn on/off boosting the bass frequency. **B.BOOST** is displayed when it is activated.

Muting Audio

Press **MUTE** on the remote control to cut the sound. **MUTE** flashes on the display.

Using Preset Equalizer Curves

Press **EQ** to toggle among FLAT, ROCK, POP, JAZZ, CLASSIC and CUSTOM. **EQ** is displayed when EQ is activated.

EN

Creating a Custom Curve

1. Press **EQ** to select CUSTOM mode.
2. While CUSTOM is displayed, press **◀◀** or **▶▶** to cycle among displayed bass and treble range levels.
3. While BAS and TRE is displayed, adjust volume control to set the associated gain between -10 - +10.
4. Press **EQ** to exit.

CD and mp3 Disc Playback

Important CD and mp3/WMA Information



This unit is compatible with CD-RW/ CD-R discs for playback.



Notes on CD-R/W Disc:

- Do not affix any type of labels to either side (recordable or labeled side) of a CD-R/RW disc as this may result in the unit malfunctioning.
- To avoid damages to the CD-R/W disc, do not open the disc compartment door while the disc is being read.
- Do not load an unrecorded CD-R/W disc into the unit. This may take a longer time to read the disc.
- Playback capability for CD-RW discs may vary due to variations in the quality of the CD-RW disc and the recorder used to create the disc.



Notes on mp3/WMA Disc:

- Use .mp3 as the extension when converting audio files into mp3 for saving onto CD-R(W) or CD-ROM, e.g. Abc08.mp3. Do not use any other extension e.g. .doc, .pdf.
- Do not use the .mp3 extension for other text or non-audio data files as this may result in serious malfunction and harmful noise interference.
- For better quality in mp3/WMA disc playback, the CD quality should be recorded 128kbps or above.
- Disc data size > 650MB is not recommended.
- Total files and folders in the disc should not exceed 250, it also depends on the length of the file/folder names.
- For mixed mode discs, only one mode will be selected for playback depending on the recording format.
- To ensure good performance, wait until the disc changer completely reads the disc before proceeding.
- mp3 files in CD ROM EXTRA format disc cannot be recognized.

CD and mp3 Disc Playback

EN

Loading Discs

1. Press **SOURCE** repeatedly to select CD mode.
2. Press **DISC 1** / **2** / **3** / **4** / **5** on the main unit to open the desired disc tray.
3. Insert a disc with label face up.
4. Press the same **DISC** key to close the disc tray, or press a different **DISC** key to open a different disc tray directly.
5. Repeat steps 2-4 to load discs in all the disc trays.

A Solid disc tray icon lights on the display indicating that the corresponding tray is occupied. The current disc tray icon flashes on the display.

If the disc is a mp3 / WMA CD, the respective **mp3** or **WMA** icon lights on the display.



Note:

Be sure to remove all discs from the disc compartment before moving or transporting the unit.



Tips:

In TUNER, PC, USB, PORTABLE PLAYER or AUX mode, the corresponding disc will start playback when **DISC 1** / **2** / **3** / **4** / **5** is pressed. If there is no disc in the corresponding disc tray, the current disc will be set to the next occupied tray.



Tips:

While playing one disc, you can open or close other disc trays to load or change disc without interrupting the playback.

Play Discs

- **To play all discs in the disc tray**
 - Press in stop mode to play all discs.
- **To play a specific disc**
 - Press **DISC SKIP** on the main unit to switch to the next disc.

- **To play a specific track in the disc**

Press or to select the track and press to start playback.



Attention:

Do not push to force closing of the tray during CD playback or tray opening.

Pause Discs

Press during playback to pause disc. Press again to resume.

Stop Playback

During playback, press to stop playback. The unit returns to navigation mode briefly (approx. 10 seconds) before entering stop mode.



Tips:

In CD stop mode, press to enter navigation mode and show disc menu. In CD navigation mode, press to return to stop mode.

Selecting a Disc

Press **DISC SKIP** to skip discs.

Skipping Tracks

- Press or to skip to the previous or next track.

Scanning Tracks

- Press and hold or to search through a CD while it is playing.

Program Playback

Refer to page 16 for details.

USB and mp3 Player Playback

The playback controls of USB devices and mp3 player are basically the same. Connect the devices first and then you can start playback.

Connecting USB device to the Main Unit

Insert the the USB device's USB port into the main unit's USB connector. Unplug the device to disconnect.

Connecting the mp3 Player to the Main Unit

1. Press and hold the lock button on the back of the player and push the USB connector out from the player.
2. Insert the the mp3 player's USB port into the the main unit's USB connector for the player.

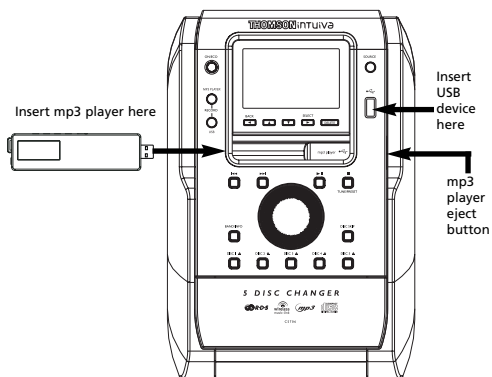

Disconnecting the mp3 player from the Main Unit

Press eject button on the right side of the unit to disconnect the player.

EN

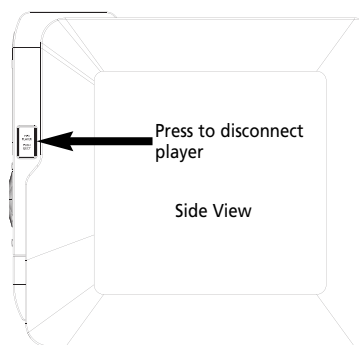

Selecting USB or Portable Player Mode

Press **SOURCE** repeatedly to select USB or PORTABLE PLAYER mode.

USB/mp3 player Playback Features

Start and Pause Playback

Press **▶||** to start and pause playback.

Stop Playback

Press **■** to stop playback. The unit enters navigation mode for 10 seconds before entering stop mode.

Skipping Files

- Press **◀◀** or **▶▶** to skip to the previous or next file.
- Press and hold **◀◀** or **▶▶** to search through a file while it is playing.

Memory Usage

Press **BAND/INFO** on the main unit or on the remote control to view memory usage on the USB device or the mp3 player.

Radio

EN

Selecting Tuner Band

1. Press **SOURCE** to enter TUNER mode.
2. Press **BAND** to select between FM, MW or LW Radio band.

Tuning to a Station

Press **◀◀** or **▶▶** to select frequencies. Press and hold **◀◀** or **▶▶** to scan frequencies.

Using Presets

The tuner can be in either TUNE or PRESET mode.

- Press **■ TUNE/PRESET** to toggle TUNE and PRESET mode.
- Press **◀◀** or **▶▶** to access the previous or next preset station.



Tips:

Under PRESET mode, press **◀◀** or **▶▶** can only access the preset stations. Manually tuning is not accessible in this mode.

Auto Preset Programming (FM only)

Press and hold the **BAND** button for 2 seconds to scan stations in FM band. The stations will then be stored as preset channels. A maximum of 32 stations can be stored. Beware of your preset channels being erased accidentally because the scanning and storing process is automatic upon pressing the button. You can stop the automatic scan by pressing any button, but the erased stations cannot be recovered.

Manually Setting Presets

1. Press **■ TUNE/PRESET** to enter TUNE mode.
2. Press **◀◀** or **▶▶** to access the desired frequency.
3. Press the **PROGRAM** button once and the most recently accessed program location flashes on the display.
4. If a different program location is preferred, press **◀◀** or **▶▶** to move to the desired preset number (1-32).
5. Press **PROGRAM** to store the selected frequency at that preset.

Suppressing Stereo Signal

Press **FM ST** on the remote control to toggle between FM mono and stereo mode. **Stereo** is displayed in stereo mode.

Tuning to an RDS Station

1. Press **◀◀** or **▶▶** to go to your desired frequency.
2. If a RDS station found, RDS lights on display with station name shown.



Note:

RDS stations broadcast on FM only. When the tuner detects an RDS signal, the RDS icons turns on.

Displaying RDS Station Information

Press **REPEAT/RDS** on the remote control repeatedly to display the following:

- frequency,
- station name (PS),
- station type (PTY),
- clock time (CT), or
- radio text (RT).

In CT mode, press the **INTRO/CT** key to replace the displayed time with RDS station time.

Searching by Program Type (PTY) (Remote Only)

1. Press **◻ / PTY** to enter PTY selection
2. Press **◻ / PTY** repeatedly to select a PTY mode.
3. Within 5 seconds, press **◀◀** or **▶▶** to search for a station broadcasting the selected type of program.

You can search for stations using one of the following program types:

NEWS, AFFAIRS, INFO, SPORT, EDUCATE, DRAMA, CULTURE, SCIENCE, VARIED, POP M, ROCK M, MOR M, LIGHT M, CLASSIC, OTHER M, WEATHER, FINANCE, CHILD, SOCIAL, RELIGION, PHONE, TRAVEL, HOBBY, JAZZ, COUNTRY, NATION, OLDIES, FOLK M, DOCUMENTARIES, TEST, ALARM.

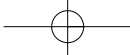

Microphone Input

You can connect a microphone (not included) to the unit. The output will be processed from the speaker when you are singing or speaking with your microphone.

Connecting your Microphone

Connect your microphone to the **MIC INPUT Connector** at the back panel of the unit.

Adjusting Volume

- To turn on the power supply of the mic input, rotate the **MIC VOLUME** dial clockwise until a 'click' sound is heard.
- To increase the microphone input volume, rotate the **MIC VOLUME** dial clockwise.
- To decrease the microphone input volume, rotate the **MIC VOLUME** dial counter-clockwise.
- To turn off the power supply of the **MIC INPUT**, rotate the **MIC VOLUME** dial counter-clockwise until a 'click' sound is heard.



Note:

The main unit's **VOLUME**

CONTROL adjusts the volume level of both the current playing source and the microphone. The **MIC VOLUME** adjusts only the volume level of the microphone itself.



Note:

- To achieve the best performance, you are recommended to keep the microphone about 5-10cm away when speaking and singing to the microphone.
- Sound feedback happens usually when the microphone is too close to the speaker. It can be avoided by not pointing the microphone to the speaker while it is on.
- The **MIC INPUT** feature of this unit is designed to receive your vocal signal input (singing or speaking) from the microphone. It is not suitable for receiving musical signal with rich bass or treble.
- If you are not going to use the microphone for a long time, you are recommended to turn off the power supply of the **MIC INPUT** by rotating the **MIC VOLUME** dial counter-clockwise until a 'click' sound is heard and disconnect the microphone.

EN

Microphone Input Recording

Refer to page 14 for details.

Singing or Speaking with your Microphone

1. Connect your microphone to the unit and adjust the **MIC VOLUME** to desired level.
2. To sing with your microphone, press **SOURCE** to select among CD, TUNER, PORTABLE PLAYER, USB or AUX. Your vocal signal input from the microphone will be mixed with the current playing source signal and outputted from the speakers (or earphones if connected).
3. To sing or speak without mixing with the current playing source, press **SOURCE** to select AUX. Disconnect the AUX input (if any) from the unit. Your vocal signal input from the microphone will be outputted from the speakers (or earphones if connected).

Recording to the mp3 Player/USB

Recording to mp3 player or USB device are basically the same. You can record CD, TUNER or AUX files to the mp3 player or USB device.

EN

Recording CD to mp3 Player

Normal/High Speed Recording

1. Connect the mp3 player to the USB port, "USB Connected" will show on the display of the player.
2. In CD stop mode or CD navigation mode, press **RECORD-MP3 PLAYER** on the main unit or press **REC ► P. PLAYER** on the remote control.
3. Press **▲**, **▼** or rotate **VOLUME CONTROL** to select Normal or High Speed.
4. Press **►**, **RECORD-MP3 PLAYER** on the main unit or press **REC ► P. PLAYER** on the remote control to confirm selection.
5. Press **▲**, **▼**, **◀** or **▶** to select track and then press **▶||**.
The unit will start playback and recording will begin. **REC** is displayed.
6. Press **■**, press **RECORD-MP3 PLAYER** on the main unit or press **REC ► P. PLAYER** on the remote control to stop recording.



Note:

- High speed recording mode can save time when recording from CDs. It is normal that the pitch is increased during high speed recording.
- High speed recording is for CD recording only.

Example (Record all 5 CDs):

1. Make sure **ALL DISCS** mode is selected by pressing **REPEAT** repeatedly.
2. Follow the above step 1-6.

Example (Record only selected tracks from a CD):

1. Create a CD program by following instructions under "Setting Up a CD Program" on page 15.
2. In CD stop mode or CD pause mode, press **RECORD-MP3 PLAYER** on the main unit or press **REC ► P. PLAYER** on the remote control.

3. Press **▲**, **▼** or rotate **VOLUME CONTROL** to select Normal or High Speed.
4. Press **►**, **RECORD-MP3 PLAYER** on the main unit or press **REC ► P. PLAYER** on the remote control to confirm selection.
5. Press **PROGRAM** to enter program playback mode.
Playback and recording will begin. **PROGRAM** and **REC** is displayed.
6. Press **■**, press **RECORD-MP3 PLAYER** on the main unit or press **REC ► P. PLAYER** on the remote control to stop recording.



Tips:

To view remaining time (Rem), press **BAND/INFO** in recording mode.



Tips:

If CD playback is already started, recording will begin instantly when

RECORD-MP3 PLAYER on the main unit or **REC ► P. PLAYER** on the remote control is pressed.

If CD playback is stopped, select Normal/High speed using **▲** or **▼** then press **►** to confirm selection. Press **▲**, **▼**, **◀** or **▶** to select track and then **▶||** to start recording. Recording will not start until CD starts playback.



Tips:

Recording stops automatically when CD stops (For example: end of disc is reached).



Note:

The encoding bitrate for tuner, CD and AUX signal are as below:
CD / Aux : 128 kbps
Tuner : 96 kbps

Recording to the mp3 Player/USB

Recording TUNER/AUX to mp3 Player

1. In TUNER or AUX mode, press **RECORD-MP3 PLAYER** on the main unit or press **REC ► P. PLAYER** on the remote control to start recording.

Example:

1. In TUNER mode, select the station to record (refer to page 11 for details).
2. Press **RECORD-MP3 PLAYER** on the main unit or press **REC ► P. PLAYER** on the remote control to start recording.
3. Press **■**, press **RECORD-MP3 PLAYER** on the main unit or press **REC ► P. PLAYER** on the remote control to stop recording.

Program Recording

Refers to "Setting the Timer" on page 7.

Recording with Microphone Input

You can record the microphone input in TUNER or AUX mode. Connect your microphone to the unit and adjust the **MIC VOLUME** to desired level.

In TUNER mode

1. Press **SOURCE** to select TUNER.
2. Press **RECORD-MP3 PLAYER** on the main unit or press **REC ► P. PLAYER** on the remote control to start recording.
3. Your vocal signal input from the microphone will be mixed with the TUNER's signal and saved as an mp3 file.

In AUX mode

1. Press **SOURCE** to select AUX.
2. To sing or speak without mixing with the AUX's signal, disconnect the AUX input (if any) from the unit.



Tips:

Do not disconnect the AUX input if you want to mix it with the vocal signal during recording.

3. Press **RECORD-MP3 PLAYER** on the main unit or press **REC ► P. PLAYER** on the remote control to start recording.
4. Your vocal signal input from the microphone will be saved as an mp3 file.

Recording to USB Device

Follow the steps of "Recording CD/TUNER/AUX to mp3 player" in the last section by pressing **RECORD-USB** on the main unit or **REC ► USB** on the remote control instead of **RECORD-MP3 PLAYER** on the main unit or **REC ► P. PLAYER** on the remote control.

Recording Information

During recording, press **BAND/INFO** to display the current file name, recording speed (in CD Recording mode only) and remaining recording time (Rem) cyclically. Press **BAND/INFO** again to quit.

File Name 04:30 NORMAL SPEED RECORDING	recording speed (in CD Recording mode only)
File Name 04:30 Rem: >3h	remaining recording time

Deleting Files from mp3 Player/USB device

1. In navigation mode, select the file to delete using the navigation buttons. (Refer to "Navigation Buttons" on 7 for details.)
2. Press **DELETE** on the remote control.
3. Rotate the **Volume Control** on the main unit or on the remote control to select Yes to delete or No to cancel.
4. Press **►** to confirm selection.

Deleting All Files

1. To delete all the files on the USB device, press and hold **DELETE** on the remote control in navigation mode and mp3 stop mode.
2. Rotate the **Volume Control** on the main unit or on the remote control to select Yes to delete or No to cancel.
3. Press **►** to confirm selection.

EN

Wireless Musiclink

EN

Wireless Musiclink allows you to have remote access to the Windows Media Player Library in your computer. Refer to page 3 to install the required software and driver first before you start music playback.

Connecting your Unit to the Computer

1. Press **SOURCE** to select PC mode.
2. Adjust the Wireless Musiclink antenna at the back of the unit to face skyward as illustrated.

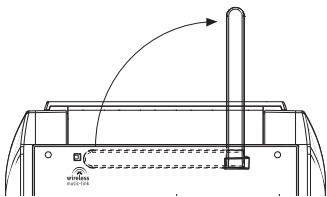

3. Connect the included USB cable to the Wireless Music Link Transceiver.
4. Connect the other end of the USB cable to your computer's USB port.
5. Adjust the antenna of the Transceiver to face skyward as illustrated.
6. **PC Searching** and **PC Connecting** will be shown on the main unit's display. **PC No Connect** will be displayed if no PC connection is found.
7. A connection icon will be displayed on the right hand corner of your computer. This icon indicates the connection between your unit and your computer.

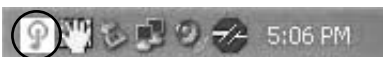
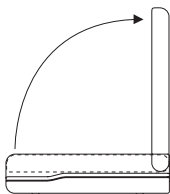

Tip:

For the main unit to show CD and Song information, your PC must be turned on connected to the internet. For further detail on the internet connection, check the readme file in the included CD-ROM, or use the HELP option in the Wireless Music Link program installed on your PC.

Playing Music via Wireless Music Link Transceiver

1. Press **◀◀ / ▲** or **▶▶ / ▼** to select among **All music, Genre, Artist, Album** and **Playlists** in your Windows Media Player Library.
2. Press **▶** to confirm the selected items or **◀** to return to the previous menu level. If the selected item is a song, playback will start.

Playback Features

Start and Pause Playback

Press **▶||** to start and pause playback.

Stop Playback

Press **■** to stop playback and display the song list.

Skipping Files

- Press **◀◀ / ▲** or **▶▶ / ▼** to skip to the previous or next file.
- Press and hold **◀◀ / ▲** or **▶▶ / ▼** to search through a file while it is playing.

Advanced Playback Controls

In CD and USB mode, advanced playback controls allow you to sample, repeat and random playback files, set up a Program List. In USB mode, allow you to rename tracks.

Sampling Tracks

Press **INTRO/CT** on the remote control to play the first 10 seconds of each track on the current disc, all discs in the tray, or turn intro mode off.

INTRO is displayed when sampling is activated.

Repeat

Press **REPEAT/RDS** on the remote control to toggle repeat options:
 Repeat the current track (REPEAT 1),
 Repeat all tracks in USB, PORTABLE PLAYER or MP3/WMA mode (REPEAT ALL),
 Repeat current disc (REPEAT 1 DISC),
 Repeat all discs (REPEAT ALL DISC), or
 Normal playback (ALL DISCS).

Random Playback

Press **/PTY** on the remote control to turn on/off random playback. **/PTY** is displayed when it is activated.

All the tracks on one disc will be shuffled and played once before shuffling and playing tracks from the next disc.



Tips:

Random playback can be activated simultaneously with repeat 1 disc (randomly play tracks from one disc repeatedly) or repeat all discs (randomly play tracks from all discs repeatedly).

Setting Up a Program List

1. In navigation mode, press **DISC SKIP** to select disc.
2. Use the navigation buttons to select the track to add to Program List.
3. Press **ADD** on the remote control to add selected track into the next available program location.
4. Repeat steps 1 to 3 to store more tracks into program memory.
5. Wait for a few seconds timeout to return to navigation mode.

Playing a Program List

Press **PROGRAM** to enter program mode and then press **▶||**. Program playback will begin. **PROGRAM** is displayed.

Display Program List

1. While CD playback is stopped, press **PROGRAM** to enter PROGRAM mode. To display program list, press **■**.
2. Press **▲** or **▼** repeatedly to view each track assignment in the program list.



Note:

You can create a program of up to 32 tracks.



Note:

In CD stop mode, press **PROGRAM** to toggle between program mode and normal mode.

Deleting from Program List

1. While in PROGRAM mode, press **▲** or **▼** to select the program to delete.
2. Press **DELETE** on the main unit or on the remote control.
3. Press **▲** or **▼** to select between No to cancel and Yes to confirm.
4. Press **▶** to confirm selection.

Deleting the Entire Program List

Follow the above steps by press and hold **DELETE** on the main unit or on the remote control instead of press and release.

Renaming Tracks

You can rename tracks in the USB device or the mp3 player.

1. In USB or PORTABLE PLAYER navigation mode, press **PROGRAM** on the remote control to enter rename mode.
2. Press **▲** or **▼** to select alphabets.
3. Press **▶** to confirm the current alphabet and move to the next alphabet.
4. Press **PROGRAM** to confirm and store the new file name after editing the last alphabet.
5. Press **◀** to edit the previous alphabet.
6. Press **DELETE** to delete the alphabet.

EN

Advanced Navigation Controls

File Navigation

Main Unit

EN

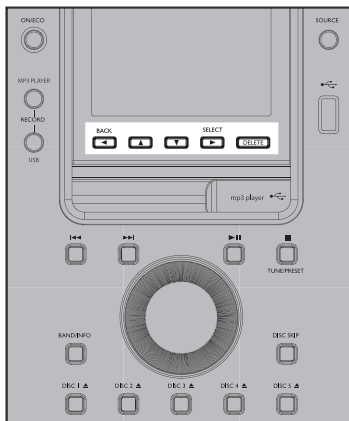

DELETE - Deletes the selected item.

▶ **SELECT**

- *From stop mode* - Enters navigation mode.
- *In navigation mode* - Plays selected track or enters selected folder.

◀ **BACK**

- Exits current folder and returns to higher level.
- Exits navigation mode after returning to the top layer.

▲ / ▼ - Moves up/down a list.

Music Navigator Remote

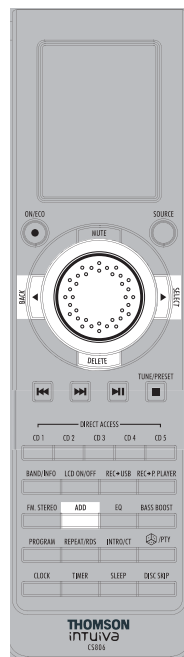

Use **VOLUME CONTROL** dial to select items.

▶

- *From stop mode* - Enters navigation mode.
- *In navigation mode* - Plays selected track or enters selected folder.

◀

- Exits current folder and returns to higher level.
- Exits navigation mode after returning to the top layer.

ADD - *In CD, USB, PORTABLE PLAYER, or MP3/WMA mode* - Adds track to Program List.

DELETE

- When reviewing program, removes track from Program List.
- *In USB or PORTABLE PLAYER mode* - Removes file from the connected USB device or mp3 player.
- *In rename mode* - Deletes current alphabet.

Advanced Navigation Controls

Display

In navigation mode, the display looks like the following. Selected item is blackened.

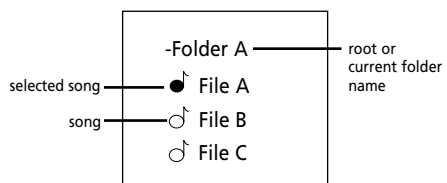
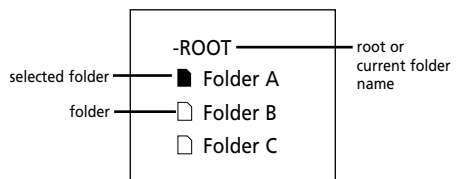
EN

Advanced Navigation Controls

EN

Tips on Playback Sequence of Disc

- Check that the mp3/WMA disc is created with a single folder structure. Refer to the diagram below for playback sequence details on multi-level folder structure.
- For example, folders and songs from level 2 are played before moving on to play folders and songs from level 3.

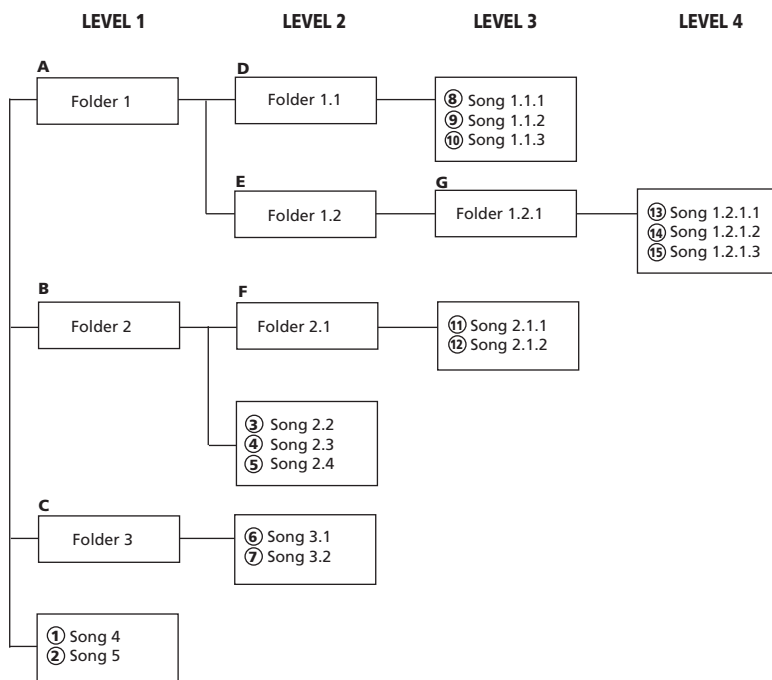

Note:

- Folder playback sequence is indicated by the letters A to G.
- Song playback sequence is indicated by the numbers (1 to 15) in front of the song name.

mp3 Player

Insert battery into the Player

1. Slide the battery door by following the direction of arrow.
2. Insert a "AAA"(UM4) battery with polarities corresponding to the indications in the compartment.
3. Replace the door to the battery compartment.



Note:

This unit may temporarily cease to function if subjected to electrostatic disturbance. To resume normal operation, it may be necessary to cycle the power off and back on or to remove and reinstall the batteries.

General Controls

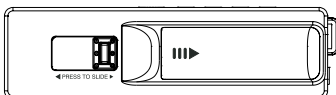
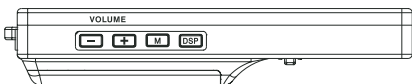
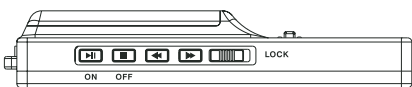

- ▶▶ - Press once to turns the unit on. In play mode, press once to starts and pause music playback.
- - In stop mode, press once to turn off the unit. Press once to stop music playback.
- ◀◀ - Skips to the previous song or the beginning of the current song. Press and hold to scan backwards.
- ▶▶ - Skips to the next song. Press and hold to scan forward.
- LOCK** - Slide the switch to lock or unlock the keys of the player
- Headphones Jack** - Insert headphones here.
- 🔌 - Use the USB port to connect to the Audio System.
- USB lock button** - Press and hold and push the USB connector out form the unit.

VOLUME + / - - Increases and decreases the volume level.

M - Selects among playback options. (repeat one, repeat all, random playback, repeat random playback)

DSP - Selects among DSP modes (Flat, Bass, Pop, Rock, Jazz)

EN

Display Overview

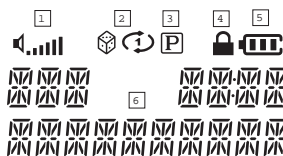

1. Shows current volume level.
2. The relative play mode indicator lights to show current selection.
 - 🔄 - repeat track
 - 🔄 - repeat all
 - 🎲 - random playback
 - 🎲 🔄 - repeat random playback
3. 🔒 is displayed when the key lock function is activated.
4. 🔋 shows the battery level.
5. This section shows song information.

The information in this section presumes you've successfully transferred files to the mp3 player, and you're ready to play some music.

Turn On/Off the mp3 player

Press ▶▶ to turn the unit on. Playback starts automatically from the first track.

Play / Pause

- Press ▶▶ to start and pause playback of selected track. Current track number, elapsed playback time and track title show on display.

Stop Playback

- During playback, press ■ to stop playback. The total number of tracks is display.
- Press ■ in stop mode to turn the unit off.

mp3 Player

EN

Skipping Tracks

- Press **⏮** or **⏭** to skip to the previous or the next track.

Scan Tracks

- Press and hold **⏮** or **⏭** to scan backwards and forwards during playback.



Note:

If the elapsed time of the playing track is less than 0:04, pressing **⏮** once will return to previous track.

If the elapsed time of the playing track is more than 0:04, pressing **⏮** once will return to the beginning of the current track.

Adjusting the Volume

Press **VOLUME +/-** to adjust the volume.

Key Lock

- To avoid accidental key activation, slide the key lock switch to the left. **🔒** is displayed.
- Slide to the switch to the right to unlock.



Note:

When the unit is in off mode and the key lock switch is at the LOCK position, pressing the **▶||** key will cause the display to show the key lock icon for three seconds.

DSP

Press **DSP** repeatedly to select among DSP modes:
 FLAT > BASS > POP > ROCK > JAZZ
 The current selection shows briefly on the display.

Play modes

During playback, press **M** repeatedly to select among the following playback modes:

Normal playback

Repeat Track -

Repeat All -

Random Playback -

Repeat Random Playback -

Check for Updates

Visit www.thomson-lyra.com for the latest news and firmware upgrades for our Lyra Digital Audio Player. You must update your system after new downloads have been made in order for the new applications to be executed.

Frequently Asked Questions

You can get FAQ information at www.thomson-lyra.com



Note:

The unit automatically turns off after about 1 minute if there is no key activation.

Troubleshooting Tips

Main Unit

Problem	Solution	Problem	Solution
<i>System will not turn on</i>	<ul style="list-style-type: none"> • Check power cord for a secure connection. • Unplug the unit for a moment, and then plug into power source again. • Check the outlet by plugging in another device. 	<i>CD sound skips</i>	<ul style="list-style-type: none"> • Clean the disc. • Check disc for warping, scratches, or other damage. • Check if something is causing the system to vibrate. If so, move the system. • Make sure the speakers are at least 3 feet away or on a different surface from the main unit.
<i>No sound</i>	<ul style="list-style-type: none"> • Increase the volume setting. • Check connection to speakers. • Check that you have selected the appropriate function: CD, TUNER. • Make sure mute is off. • Make sure headphones are not plugged in. 	<i>CD button will not respond, or does not change discs when you press DISC SKIP</i>	<ul style="list-style-type: none"> • Switch to another function (TUNER) and then back to CD.
<i>Poor radio reception</i>	<ul style="list-style-type: none"> • Check antenna connection. • Move antenna. • Turn off nearby electrical appliances, such as hair dryer, vacuum cleaner, microwave, fluorescent lights. 	<i>Remote control does not work</i>	<ul style="list-style-type: none"> • Check that the batteries are properly installed. • Replace weak batteries. • Check the system is plugged into power source. • Point the remote directly at the system's front panel. • Move closer to the system. • Remove any obstacles between the remote and the system.
<i>CD does not play</i>	<ul style="list-style-type: none"> • Check that CD is in the tray. • Check that CD label is facing up. • Check that PAUSE mode is not on. • Check that CD function is selected. • Use CD lens cleaner. • Clean the disc. • Try another CD. 		

EN

Troubleshooting Tips

mp3 Player

EN

Problem	Solution	Problem	Solution
<i>The player does not turn on when PLAY button pressed.</i>	<ul style="list-style-type: none"> • Battery may be inserted incorrectly. • Battery may be empty. 	<i>What does the PlaysForSure logo mean?</i>	<p>PlaysForSure is a new logo program from Microsoft®. Consumers can match the PlaysForSure logo on a large selection of devices and online music stores. If you see the logo, you'll know your digital media will play for sure.</p> <p>For more information on the Microsoft PlaysForSure program, visit www.PlaysForSure.com. For more information on RCA PlaysForSure devices, visit www.rca.com.</p>
<i>Skipping tracks or bad sound quality?</i>	<ul style="list-style-type: none"> • Repeat or random function may be activated. • There may be strong magnetic fields (e.g. too close to TV) near the unit. • Low Battery level. Replace with new one. 	<i>USB display does not appear when connected to computer.</i>	<ul style="list-style-type: none"> • Check connection between your unit and the computer.
<i>Cannot perform playback?</i>	<ul style="list-style-type: none"> • LOCK function may be activated. • There may be no mp3 tracks in the card or internal memory. • Memory Card may be damaged. 	<i>The player does not respond to key operations?</i>	<ul style="list-style-type: none"> • To reset the unit, turn the player off by removing the battery. Reinsert the battery properly and turn the player on again to resume normal operations.
<i>Cannot playback tracks on the player.</i>	<ul style="list-style-type: none"> • Make sure audio tracks are encoded in the mp3 or Windows Media formats at supported bitrates. Bitrates support by the player: mp3 – 32 to 320 kbps wma – 48 to 160 kbps <p>Check the website and/or application help system of the music download service provider from where the content was purchased from for license acquisition details.</p> <p>For more information on how license acquisition works, go to www.microsoft.com/windowsmedia/drm.</p>	 <p>Note: This unit may temporarily cease to function if subjected to electrostatic disturbance. To resume normal operation, it may be necessary to cycle the power off and back on or to remove and reinstall the batteries.</p>	

Maintenance

Disconnect the audio system from the power source before performing any maintenance.

Cleaning

Clean the exterior of the system using a soft dust cloth.

CD Player

CAUTION! This system operates with a laser. It must be opened by only a qualified technician.

Handling CDs

- Do not touch the signal surfaces. Hold CDs by the edges, or by one edge and the hole.
- Do not affix labels or adhesive tapes to the label surfaces.
- Do not scratch or damage the label. CDs rotate at high speeds inside the player.
- Do not use damaged (cracked or warped) CDs

Cleaning CDs

- Dirty CDs can cause poor sound quality. Always keep CDs clean by wiping them gently with a soft cloth from the inner edge toward the outer perimeter.
- If a CD becomes dirty, wet a soft cloth in water, wring it out well, wipe the dirt away gently, and then remove any water drops with a dry cloth.
- Do not use record cleaning sprays or antistatic agents on CDs. Also, never clean CDs with benzene, thinner, or other volatile solvents which may cause damage to disc surface

CD Lens Care

When your CD lens gets dirty it can also cause the system to output poor sound quality. To clean the lens you will need to purchase a CD lens cleaner can maintain the output sound quality of your system. For instructions on cleaning the CD lens, refer to the ones accompanying the lens cleaner.

EN

Technical Specification

Power supply: 230V~50Hz

Dimensions (H x W x D mm):

Unit size - 280 x 187 x 310

Speaker - 335 x 236 x 205

CD player: Response curve (+/- 2dB): 60Hz to 5kHz

Rating Plate: Look for it at the back of the set.

Maximum size of Mass Storage Class device supported: 20 GB

Unit Weight: 18 kg

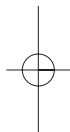
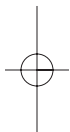
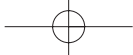

THOMSON
46, quai Alphonse Le Gallo
92648 Boulogne
Cedex FRANCE
www.thomson.net

56292830



Free Manuals Download Website

<http://myh66.com>

<http://usermanuals.us>

<http://www.somanuals.com>

<http://www.4manuals.cc>

<http://www.manual-lib.com>

<http://www.404manual.com>

<http://www.luxmanual.com>

<http://aubethermostatmanual.com>

Golf course search by state

<http://golfingnear.com>

Email search by domain

<http://emailbydomain.com>

Auto manuals search

<http://auto.somanuals.com>

TV manuals search

<http://tv.somanuals.com>