

Thomson multimedia
46/47 quai A. Le Gallo
92648 Boulogne Cedex
FRANCE
RCS nanterre
B322 019 464
55199360
www.thomson-multimedia.com

THOMSON

u
s
e
r
m
a
n
u
a
l

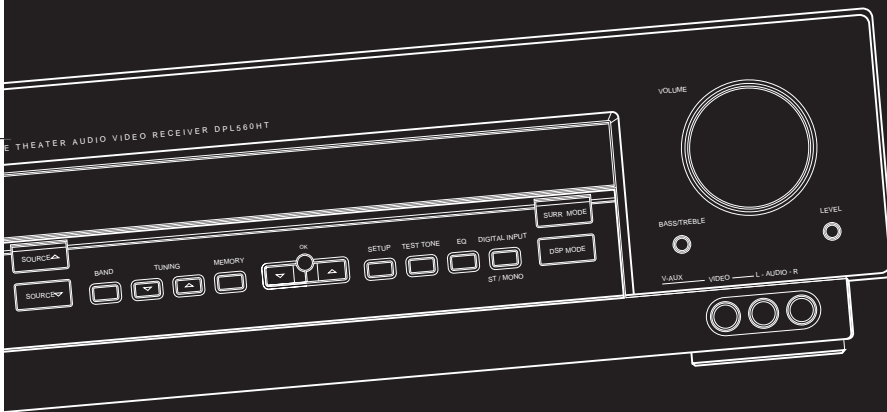

DPL560

Safety Information

For UK Only

CONNECT THE MAIN LEAD INTO A MAINS POWER SOCKET

POWER SUPPLY 230V. It must not be connected to D.C. mains.

Note; The mains lead of the set is fitted with a molded plug. If the mains socket are not compatible or if for any reason the plug is removed please follow the directions below. The molded plug cannot be rewired and if removed must be disposed of safely.

DO NOT under any circumstances plug the severed plug into any mains socket as this could result in electric shock.

Important: If the plug is removed, rewire the new plug as follow:

The wires in the mains plug are coloured in accordance to the following code:

BLUE = NEUTRAL/BROWN = LIVE

If the colours of the wires in the mains lead of this apparatus may not correspond with the coloured markings identifying the terminals in your plug, proceed as follows:

BLUE wire to the terminal coded N (Neutral) or coloured black.

BROWN wire to the terminal coded L (Live) or coloured red.

DO NOT make any connection to the terminal in the plug which is marked by the letter E or by the earth symbol or coloured green or green and yellow.

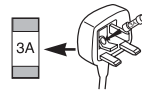

A fused plug must be fitted with a 3A fuse approved by ASTA or BS1362 and fuse covers must be always be securely replaced. If you set does not work, the fuse may be blown.

	CAUTION RISK OF ELECTRIC SHOCK DO NOT OPEN	
THE LIGHTNING FLASH AND ARROW-HEAD WITHIN THE TRIANGLE IS A WARNING SIGN ALERTING YOU OF "DANGEROUS VOLTAGE" INSIDE THE PRODUCT.	CAUTION: TO REDUCE THE RISK OF ELECTRIC SHOCK, DO NOT REMOVE COVER (OR BACK). NO USER-SERVICEABLE PARTS INSIDE. REFER SERVICING TO QUALIFIED SERVICE PERSONNEL.	THE EXCLAMATION POINT WITHIN THE TRIANGLE IS A WARNING SIGN ALERTING YOU OF IMPORTANT INSTRUCTIONS ACCOMPANYING THE PRODUCT.
SEE MARKING ON BOTTOM / BACK OF PRODUCT		

WARNING: TO PREVENT FIRE OR ELECTRICAL SHOCK HAZARD, DO NOT EXPOSE THIS PRODUCT TO RAIN OR MOISTURE.

Table of Content

Safety Information

Getting Started

Unpacking the Receiver	2
Unpacking the Speakers	3
Inserting Batteries into Remote Control	3
Set Up and Maintenance of the Receiver	3
Protect your Components from Overheating	3
Connecting to Audio-Visual Components	4
Digital Connection	5
Connecting Antennas	5
Connecting the Speakers	6
Connecting the Subwoofer	6
Positioning your Speaker	7
Front Speaker Placement	7
Surround Placement	8
Advanced Surround Setting	8
Test Tone / Channel Balance	9
Connecting for Power	9
Using Headphones	9
Factory Setting	9

Operating your Receiver

Receiver Controls	10
Your Remote Control	11
Display	12
Switching On/Off	13
Selection of Audio/Video Source	13
Using the Remote to Control Additional Components	14
Using the receiver to play a Source	15

Advanced Sound Control

Sound Enhancement Systems	19
Fine Setting of Components	20
Fine Setting of the Speakers	21
Advanced Setting	21

Care and Maintenance

Troubleshooting Tips	23
Receiver/Tuner Operation	23
Remote Control Operation	23
General	23
Cleaning the Exterior	23
Equipment Specifications	23

Remote Codes

Remote Codes	25
Language Codes	26

EN

Getting Started

Unpacking the Receiver

You should receive the following items:

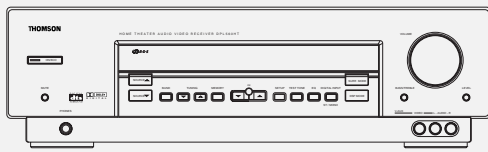

One receiver unit

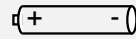

One pair of "AA" batteries

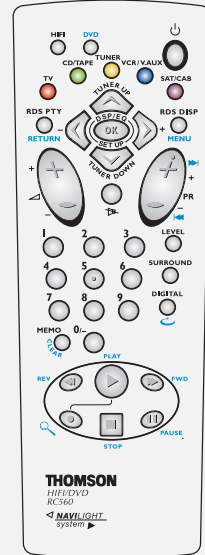

One RC560 Hi-Fi/DVD Remote Control



One Pig-Tail antenna wire



One external AM loop antenna

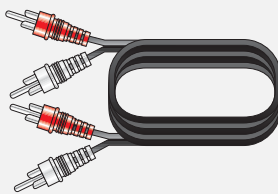

one audio cable (two wires) with red and white RCA connectors;

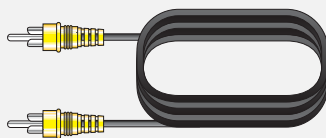

one video cable (single wire) with yellow RCA connectors;

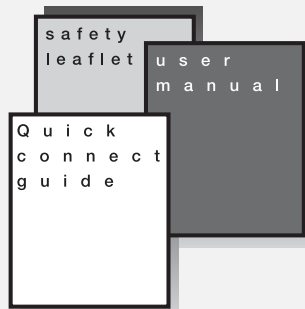

- one instruction book;
- one safety leaflet;
- one Quick Connection Guide

Unpacking The Speakers

- one set of speakers including 2 front speakers, 1 centre speaker, 1 subwoofer and 2 rear speakers.
- 6 speaker wires including:



Inserting Batteries into Remote Control

Insert two AA(R6) batteries according to the + and - signs on the battery compartment. To use the remote control, point it directly at your receiver.

Install batteries as follows:

1. Remove battery compartment door by applying thumb pressure on battery door and then lift the door out and off the cabinet.
2. Insert 2 AA batteries in the compartment and replace the compartment door.

Getting Started

Set up and Maintenance of the Receiver

EN

- Provide spaces for sufficient ventilation as indicated:

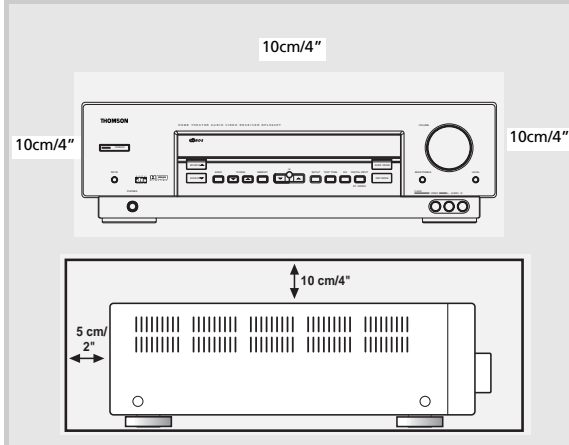

- Do not connect to the AC power cords until all connections are completed.
- Do not use your set immediately after transferring it from a cold place to a warm place: there is risk of condensation.
- Do not expose your set to water and excessively high temperatures.
- After having disconnected your set, clean the case with a soft cloth, or with a slightly damp leather chamois. Never use strong solvents.

Protect your Components from Overheating

- Do not block ventilation holes in any component. Arrange the components so that air can circulate freely.
- Do not stack components directly on top of each other.
- Allow adequate ventilation when placing your components in a stand.
- Place an amplifier near the top shelf of the stand so heated air rising from it will not affect other components. If you have a satellite receiver, you should place it on the top shelf.

Getting Started

Connecting to Audio-Visual Components

DIGITAL CONNECTION

If you have a SAT receiver DVD player or CD player with a digital output, you can make use of an optical digital cable (not supplied) or coaxial digital cable (not supplied) to carry the audio portion of the signal and enjoy Dolby Digital/DTS sound quality. One optical or coaxial cable is needed for each SAT receiver, DVD player or CD player. When optical or coaxial cable is used, the analog audio cables are still needed if recording through a tape or VCR is desired. This receiver provides one optical and one coaxial digital input for the connection of your components. Please connect your components (e.g. DVD, SAT or CD) to the appropriate digital inputs and press DIGITAL INPUT to select the corresponding digital input source.

Note: Optical and coax cables carry only the audio portion of the signal. A video connection must also be established for a SAT receiver and DVD player. Composite video (yellow RCA connector) can also be used. It is important that the same type of cable that is connected from the Home Theater to the TV is used to connect the SAT receiver or DVD player to the Home Theater.

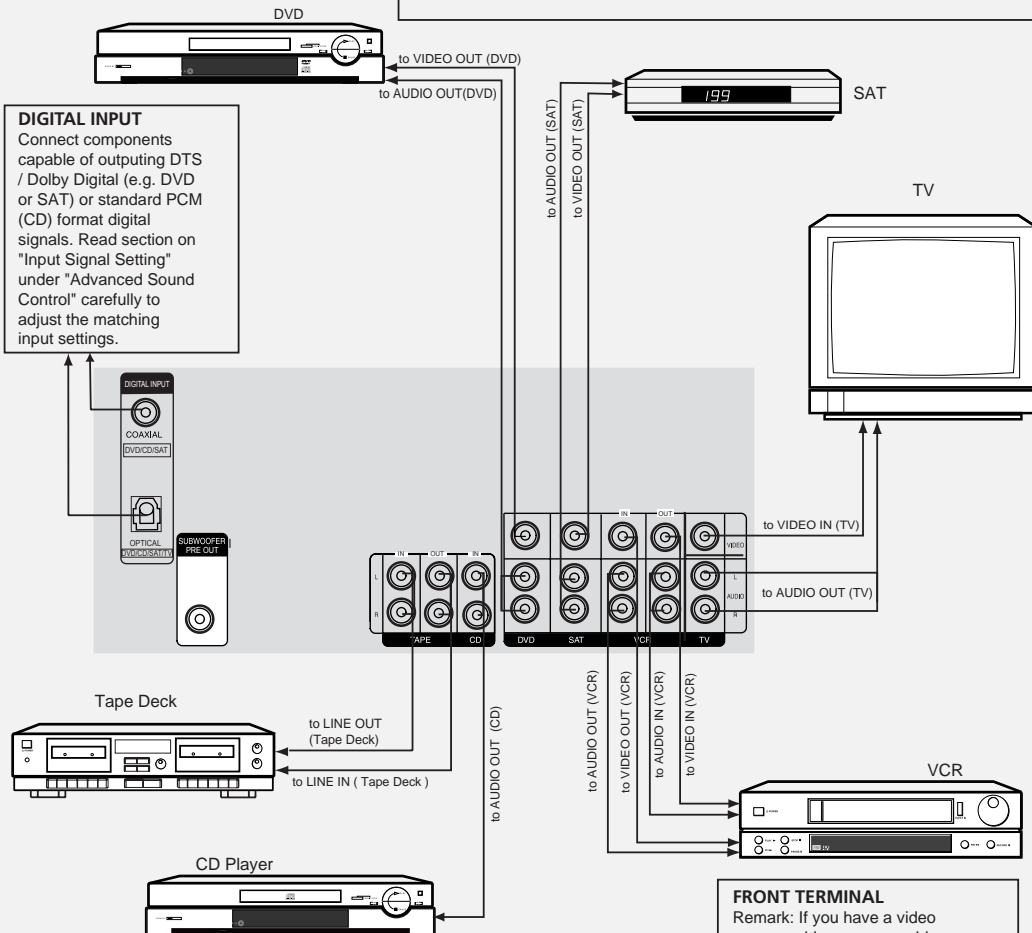

DIGITAL INPUT
Connect components capable of outputting DTS / Dolby Digital (e.g. DVD or SAT) or standard PCM (CD) format digital signals. Read section on "Input Signal Setting" under "Advanced Sound Control" carefully to adjust the matching input settings.

If your CD player is equipped with digital optical jacks, use of optical cable is preferred. What you need is just one more optical digital connecting cable (not supplied). Plug it in the digital input jack of the receiver and select OPTICAL on the receiver setting (see details on pg 20 chapter "Input Signal Setting"). You can enjoy better sound quality brought to you by the optical cable. When optical cable is used, analog cables are still needed for recording to tape output.
Note: This receiver has one digital optical jack only. Be sure that such connection does not prevent optical cable connection of other components (e.g. DVD & SAT)

FRONT TERMINAL
Remark: If you have a video camera, video game machine, or an extra VCR, connect it to VAUX input at the front of the receiver

Digital Connections

Read instructions carefully when connecting components to the receiver.

Digital In Jacks can accept Dolby Digital (AC-3), DTS or PCM signals when compatible components are connected.

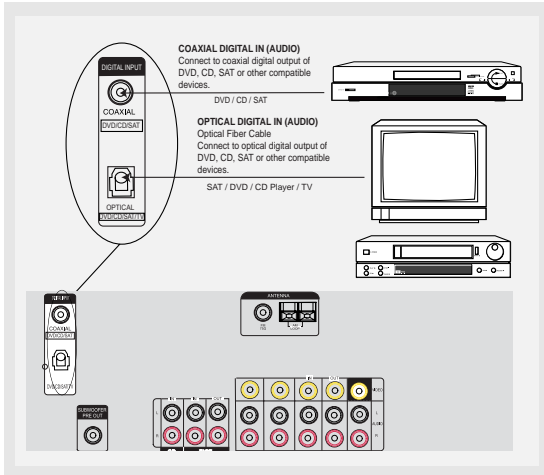

Connecting the Antennas

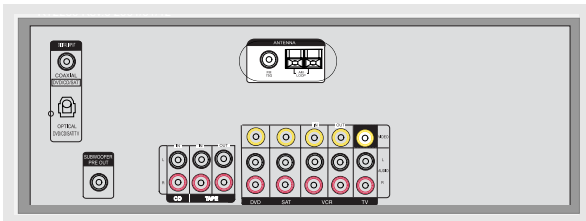

The AM and FM antennas connect to the AM and FM terminals on the system's back panel.

They must be hooked up in order to receive clear reception.

Getting Started

AM Loop Antenna and FM Indoor Antenna

1. Uncoil the Antenna wire and locate the base end of the AM antenna and snap into place as shown below in AM Loop Antenna.
2. Press down on the Antenna tab to open the terminal.

EN

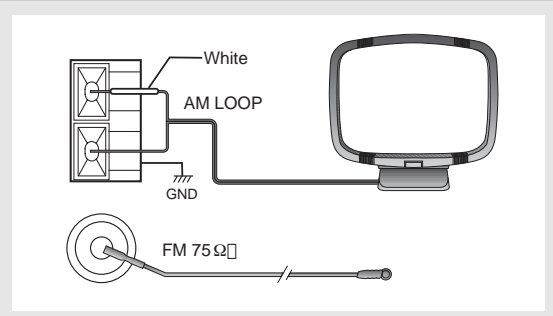
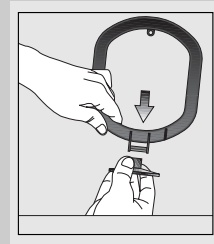

HINT

- For FM reception, extend antenna to its full length and arrange the Antenna as a T Shape
- For AM reception, rotate the antenna horizontally to get better reception.

Getting Started

Connecting the Speakers

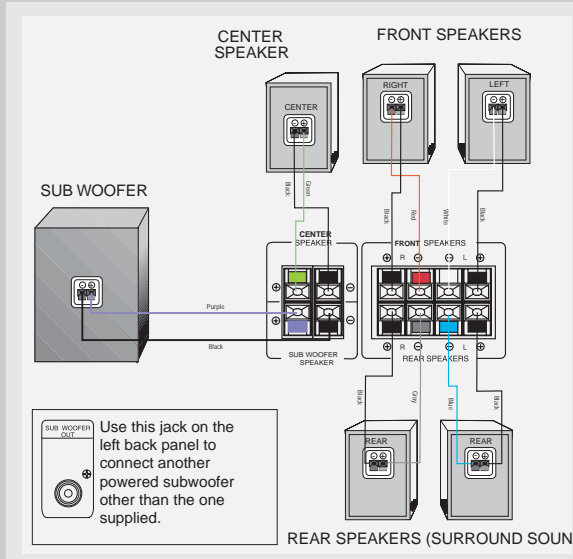

To ease speaker connections, the speaker wires and the terminals are color-coded.

- White/Black (Front Left Speaker),
- Red/Black (Front Right Speaker),
- Green/Black (Center Speaker)
- Blue/Black (Rear Left Speaker).
- Grey/Black (Rear Right Speaker).
- Purple/Black (Subwoofer)

Connect the L, R speakers at the back of the speakers to the corresponding color on the receiver. Do the same for center (with green/black terminal), rear speaker and the subwoofer (with purple/black terminal).

Speaker Polarity

When connecting the speakers, make sure the polarities (“+” speaker wire to “+” on the receiver) of speaker wires and terminals are matched. If the wires are reversed, the sound will be distorted and will lack bass (“out of phase” effect).

Speakers

There are 6 speakers equipped with the unit (2 front, 1 center, 2 rear, 1 subwoofer). In order to enjoy good surround effects, all six speakers need to be connected to the receiver.

At least two front speakers (left and right) are required. For better sound quality, Center speaker, rear speakers and Subwoofer should also be connected. Adding center and rear speakers will enhance surround effects. Adding a Subwoofer will increase bass response.

If you want to enjoy full range of sound effects, with small speakers, it is a must to use the subwoofer with the speakers to maintain adequate bass signal.

Connecting the Subwoofer

Connect the subwoofer with the speaker wire (purple/ black) provided.

This receiver offers a high flexibility for user to use a large variety of speakers and subwoofers. For more information please refer to section “Fine Setting of the Speakers” in “Advanced Sound Control” on page 21.

Speaker wires

1 for each speaker, is needed for connection. Twist the stripped ends of speaker cord about 2/3 inch (15 mm). Press down on the tab to open the terminal and insert the wire. Release tab to lock wire in the terminal.

Antenna and Speaker Wire Connection

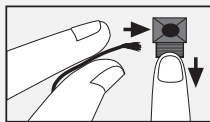

Push Speaker terminal tab down to insert wire.

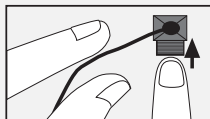

Release tab to lock wire in the terminal.

NOTE: Make sure the insulation is completely removed from the ends of the Antenna and speaker wires at all connection points.

Positioning your speaker

1 Left, Right (Front Speakers)

They carry primarily music and sound effects

2 Center

In surround mode, the center speaker carries much of the dialogue as well as music and effects. It should be set between the left and right speakers.

3 Surround (Rear Speakers)

Their overall sound balance should be as close as possible to the front speakers. Proper placement is vital to establish an evenly distributed sound field.

Subwoofer

A subwoofer is designed to reproduce powerful low bass effects (explosions, the rumble of spaceships, etc.) which dramatically heightens involvement with the action on the screen. It is therefore recommended to connect subwoofers when small speakers are used.

Magnetic shielding

Speakers placed less than two feet from the TV set must be magnetically shielded in order to prevent picture distortion. Front and center speakers provided with your unit are magnetically shielded to protect your TV set.

It is not recommended to place the rear speakers near the TV set.

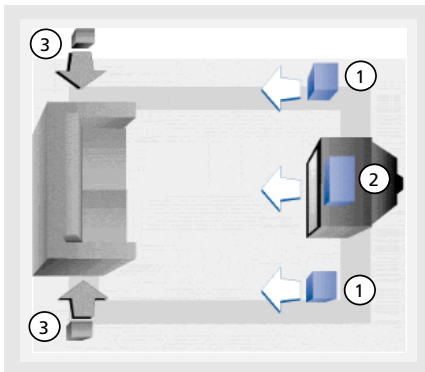

Courtesy Dolby Laboratories

Front Speaker Placement

Even if you can't duplicate this ideal home theater setup exactly, the suggestions for speaker placement that follow will help you get good results.

Getting Started

Alignment

Align the center speaker evenly with (A), or slightly behind (B), the left and right speakers, but not ahead of them.

EN

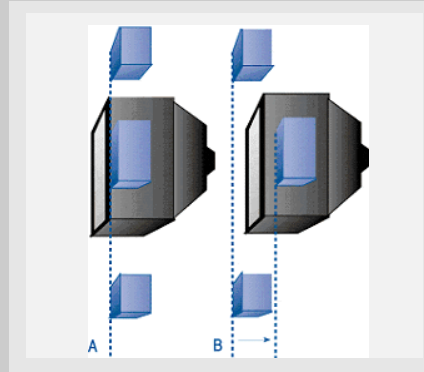

Courtesy Dolby Laboratories

Advanced Setting

Angle

Placing the left and right speakers to form a 45-degree angle with your favorite viewing position will duplicate the soundtrack mixer's perspective.

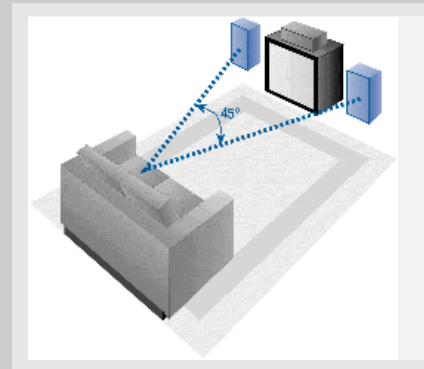

Courtesy Dolby Laboratories

Height

The three speakers should be as close as possible to the same height. This often requires placing the center speaker directly atop (A) or beneath (B) the TV set.

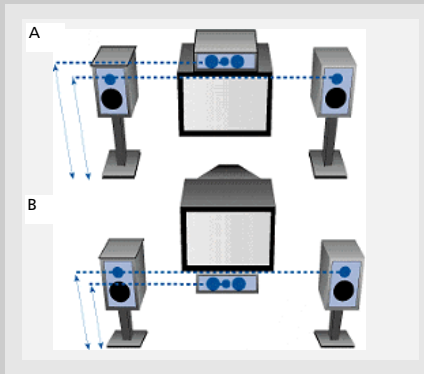

Courtesy Dolby Laboratories

Getting Started

Preferred surround placement

Location

If possible, place surround speakers to either side of the listening area, not behind it.

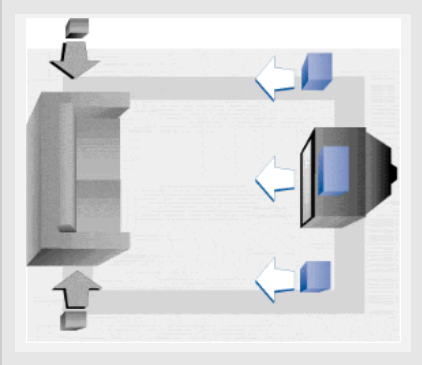

Courtesy Dolby Laboratories

Height

If space permits, install surrounds 2-3 feet above viewers. This helps to minimize localization effects.

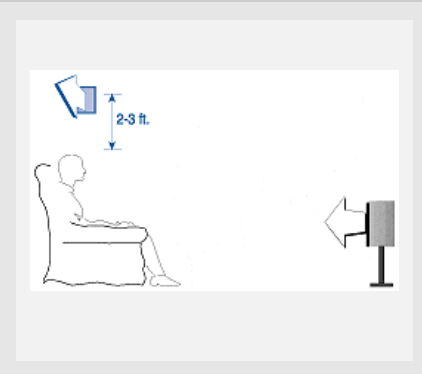

Courtesy Dolby Laboratories

Aiming

Aiming surrounds straight across the room, not down at viewers, helps create a more open, spacious surround sound field.

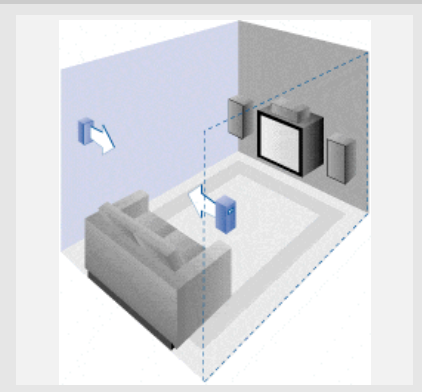

Courtesy Dolby Laboratories

Advanced Setting

Alternative Surround Placement

Rear wall

If rear wall mounting is the only choice, aim the speakers at each other (A), towards the front (B) or even towards the sidewalls (C, D). Experiment with placement until surround sounds seem to envelop you, rather than coming from behind you.

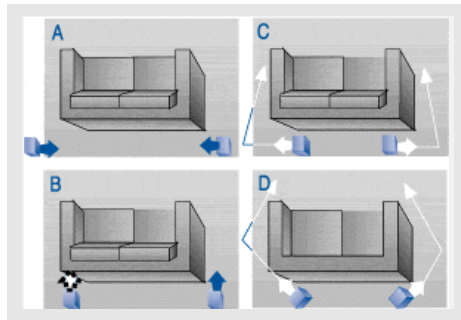

Courtesy Dolby Laboratories

No adjacent walls

Surrounds can go on stands facing each other to approximate the preferred sidewall mounting (A), or to the sides or rear of the viewing area aimed upwards. In the latter case, they can go right on the floor, or preferably, a few feet off the floor such as on end tables (B).

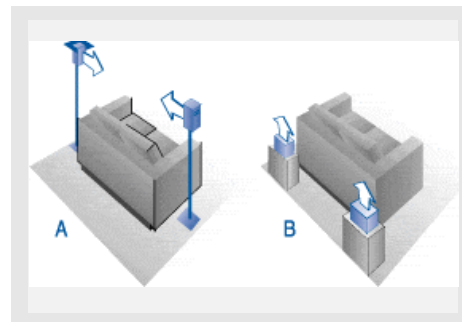

Courtesy Dolby Laboratories

Test Tone / Channel balance

Channel balance

Your receiver is equipped with a test signal generator for balancing the channels. As the signal "travels" from channel to channel, press LEVEL key to adjust corresponding channel and adjust by rotating the volume knob until all channels are at the same loudness level.

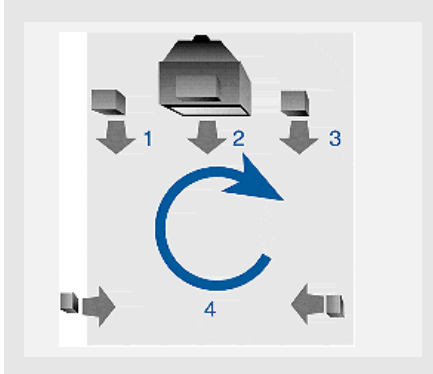

Courtesy Dolby Laboratories

Level adjustment & surround channel level expectation

Even though you adjust the surround channel to be as loud as the others on the test signal, you'll find that on actual program material the surround channel is usually much lower than the front. Don't be tempted to readjust the surround level; program producers use surround mostly for subtle atmospherics and ambience, and only rarely for special effects. A good surround mix doesn't call attention to itself; if it did, it would soon become distracting.

NOTE

The system is equipped with Dolby Digital, and manufactured under License from Dolby Laboratories.

NOTE

All preset radio stations and surround sound setting will be lost after factory setting is restored. You may restore factory setting with the following procedures:

1. Enter Standby mode
2. Press **SURR. MODE** key when holding **SOURCE UP**.
3. All preset stations will reset to FM87.5MHz and all receiver settings restore to default settings as described above.

Getting Started

Connecting for Power

Make sure you connect all your other electronic components and the speakers before plugging your receiver into the outlet. Plug the power cord in the wall outlet, matching the wide blade of the plug with the wide slot in the outlet. Be sure to insert the plug completely.

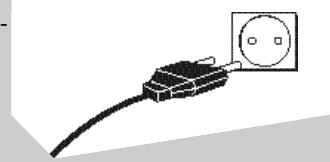

EN

Using Headphones

To listen privately through your audio system, use the PHONES jack on the receiver. However, make sure you turn down the volume before you put on the headphones. Increase the volume to the desired level after headphones are in place.



Once headphones are connected, "HEADPHONE DOWNMIX" will scroll on display. This feature automatically converts multi-channel speaker outputs to 2 channel stereo for your listening pleasure.

Hearing Comfort & Well-Being

- Do not play your headset at a high volume. Hearing experts advise against continuous extended play.
- If you experience a ringing in your ears, reduce volume or discontinue use.

Factory Setting

The DPL560 is preset to the following settings when you first power the receiver up right out of the box:

Function = Tuner
Volume setting = 45
Bass & treble = 0 dB
Speaker settings: Center, rear, front = small
Subwoofer = on



Manufactured under License from Digital Theater Systems, Inc. US Pat. No. 5,451,942 and other world wide patents issued and pending. "DTS Digital Surround", are trademarks of Digital Theater Systems, Inc. copyright 1996 Digital Theater Systems, Inc. All Rights Reserved.



Dolby Digital Manufactured under license from Dolby Laboratories. "Dolby", "Pro Logic" and the double-D symbol are trademarks of Dolby Laboratories. Copyright 1992-1997 Dolby Laboratories, Inc. All Rights Reserved.

Operating Your Receiver

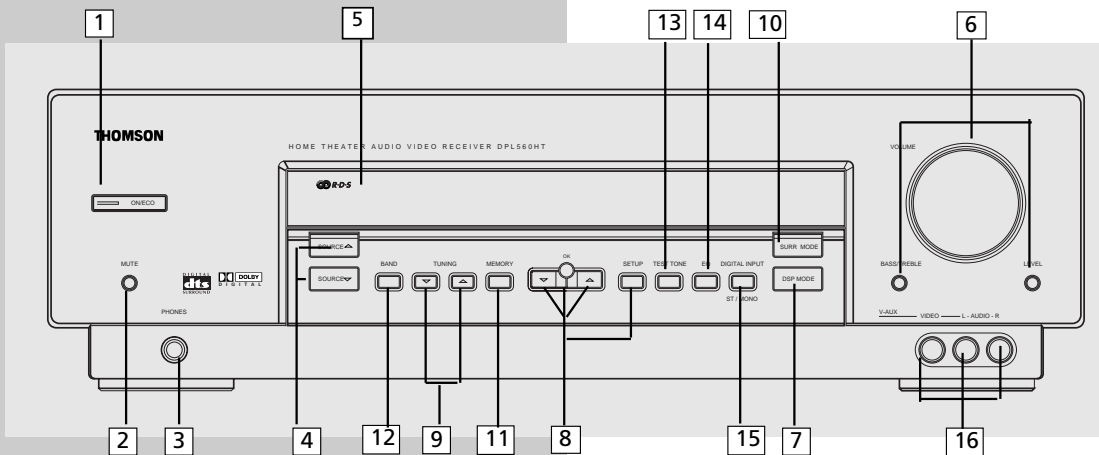

Receiver Controls

1. ON/ECO

To turn the unit on/ off. When the system is turned on, the unit will go to the mode it was in before powered off.

2. MUTE

To mute speakers and headphone out.

3. PHONES

Plug your headphones (not supplied) into it for your private enjoyment. Speakers will be off when phones are inserted.

4. Source Buttons

To select sound source. For example, CD, SAT etc.

5. Display

To display current status of the receiver.

6. Sound Control

Let you adjust the sound – volume, treble, bass & level.

- To change the VOLUME, turn the large knob.
- To adjust TREBLE or BASS, press relevant button and turn the knob. (Stereo only)
- To change the volume of individual speaker, press LEVEL button repeatedly to select the speaker, then turn the knob to adjust the level.

7. DSP (Digital Sound Processor)

Press this button to select the DSP mode (STADIUM/CONCERT/THEATRE/ARENA/CHURCH/CLUB/OFF) you want.

8. SETUP FUNCTION

- To adjust the speaker size, speaker distance, speaker phase, night mode, sleep and display dimmer.
- In SLEEP mode, you can set the receiver to turn off after 5 to 120 minutes.

9. TUNING UP / DOWN

Press for about 2 seconds to search for previous / next station in descending / ascending frequency direction.

In preset mode, press to select previous / next preset station. In tuning mode, press once to manual fine tune.

10. SURR. MODE

Press repeatedly to select the surround mode you want. (refer to "Advanced Sound Control" on page 20)

11. MEMORY

Press to toggle between manual tuning mode and preset station mode, Press and hold to manually store tuner station in preset mode.

12. BAND

Press to choose between FM/MW/LW in TUNER mode, press and hold to automatically search and save preset stations (FM only).

13. TEST tone

When pressing it briefly, a short noise (test tone) will be generated in the speakers one by one so that you can adjust the volume of individual speaker.

14. EQ

Press repeatedly to select the desirable EQ mode (music style) – OFF, CLASSIC, JAZZ, POP, ROCK, VOCAL, FLAT. Your choice will be saved automatically.(Only available in Stereo mode)

15. DIGITAL INPUT/ ST / MONO

Press repeatedly to select the input device (analog/ optical/ coaxial). In FM mode, press to toggle between stereo and mono.

16. V-AUX Input

For convenient use of your digital camera, family game machines, second VCR, etc.

Your Remote Control

Please be sure you have inserted the batteries into the remote control (see relevant section on page 3.) You can test it by pressing any button.

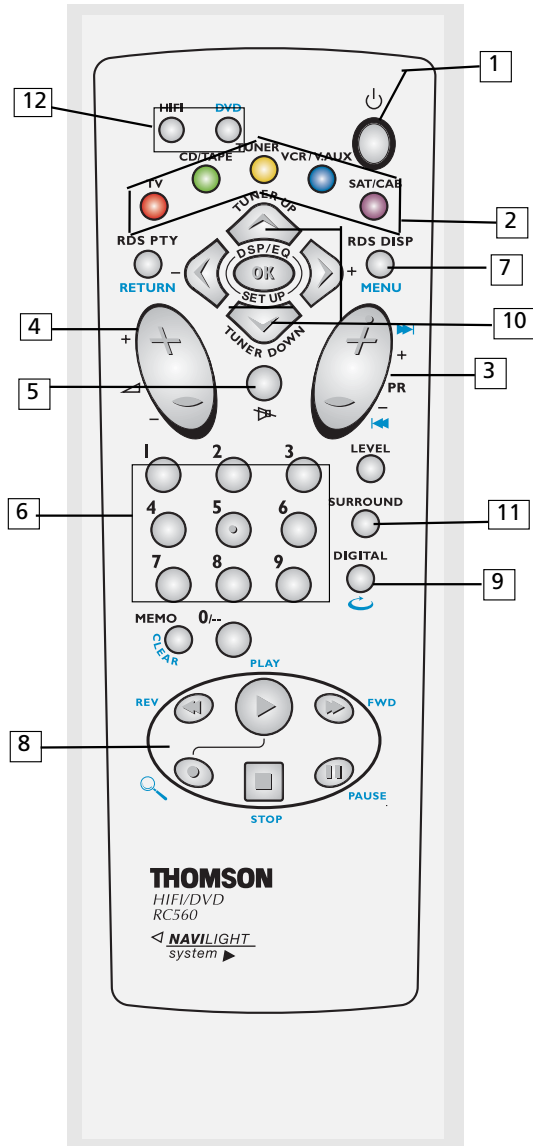

Operating Your Receiver

EN

1. ON/OFF

To turn on or off the receiver and Thomson DVD.

2. Source Buttons

To turn on and select various audio/ video sources.

3. PR+, PR- (Channel Buttons)

To select programmed stations (in TUNER mode).

4. VOL (Volume Buttons)

To adjust the volume.

5. MUTE

To mute all audio outputs.

6. Number Buttons

To access directly a pre-set station (in TUNER mode) or to peripheral devices .

7. MENU (Tuner Mode only)

- Press TUNER
- To store Preset Stations. (For details, refer to "Storing and Recalling Stations in Memory" on page 17.)

8. Operation Buttons

• PLAY, RECORD, STOP and PAUSE keys are only for easy control of Thomson DVD player, DVD. The remote control currently operates most Thomson, RCA and GE products.

9. DIGITAL

Select the way your audio/video components are connected to the receiver (Analog, Optical or Coaxial).

10. TUNER UP/DOWN

- In TUNER mode, press TUNER on the remote.
- Press TUNER UP and TUNER DOWN keys to tune down or up the radio frequency.

11. SURR (Surround Sound Control)

Press to change the surround sound settings. The display will toggle among DOLBY DIGITAL, DTS, PRO LOGIC / STEREO.

12. HIFI/DVD

Press the appropriate key to control either the receiver or a compatible DVD player (Thomson brand only)

Note: After pressing DVD, you must press HIFI to enable all receiver functions on the remote.

Operating Your Receiver

Display



DTS

- Audio output is in DTS mode.

DIG Digital

- Audio output is in Dolby Digital mode.

PRO Pro Logic

- Audio output is in Dolby ProLogic mode.

ST

- Tuner stereo signal detected.

TUNED

- Tuner station detected.

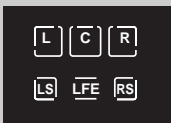

- Speaker Icons.

SLEEP

- Unit in Sleep mode.

MEMORY

- Unit in Memory mode.

KHz MHz

- Tuner frequency unit.

RDS

- Radio data system is available.

Switching on/off

- To switch on the receiver, press **ON/ECO** button once, or any source button on the remote control.

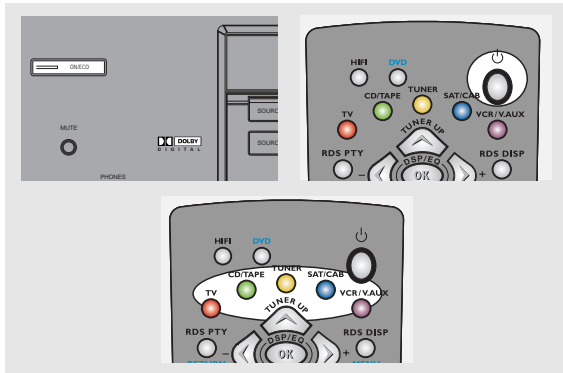

- Standby: when the receiver is on, press the **ON/ECO** button once to activate the standby mode.
- To switch off the unit completely, unplug the power cord from the socket

NOTE

Your receiver has a back up memory to keep your settings like preset radio station for about 2 weeks in case electricity outage occurs. If the receiver is unplugged for more than 2 weeks, all the settings will be lost and reset to factory settings.

Operating Your Receiver

Selection of Audio/Video source

EN

When one of the source buttons is pressed, the audio and video input corresponding to the name will be activated.

The receiver acts as a switching device between all the sources that are plugged into it.

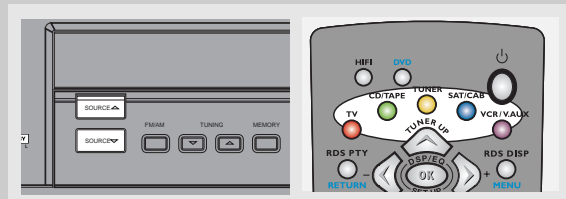

Example 1:

If you connect a DVD player to the DVD input (audio + video) on the receiver and press the source button repeatedly until **DVD** is selected, you will be able to have the sound and image transmitted by the DVD.

Example 2:

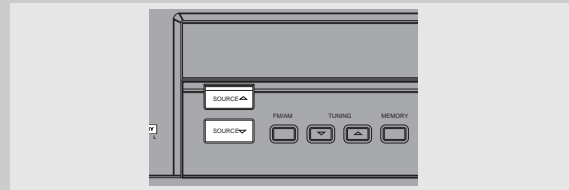

Based on the example 1, the DVD is playing, if a VCR is connected to the VCR 1 input (audio + video) of the receiver, press the **VCR/VAUX** button, or press source button repeatedly until **VCR** is selected, image and sound from the VCR source will replace the DVD.

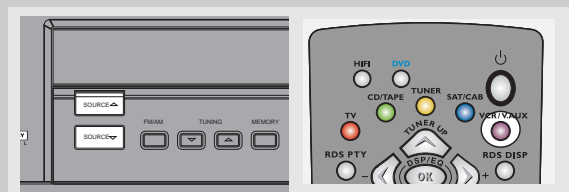

Operating your Receiver

You can connect up to 7 audio/video sources to this amplifier:

Source button (receiver front panel)	Corresponding connector (receiver back panel)
- DVD	DVD IN (audio / video)
- SAT	SAT IN (audio / video)
- VCR	VCR IN (audio / video)
- VAUX	V-AUX IN (audio / video)
- CD	CD IN (audio only)
- TV	TV IN (audio only)
- TAPE	TAPE IN (audio only)
- FM/AM	built-in

When a source is selected, the source name will be shown on the display.

NOTE

- 1. Your receiver has a built in tuner. Just connect the appropriate antenna on the back of the receiver and you will be able to listen to radio stations. (See details in Tuner section)*
- 2. Other sources can be connected to the above standard source. Example: you can connect a LD into the DVD inputs.*
- 3. Refer to the "Connecting To Audio-Visual Components" section for details on connection.*

Operating your Receiver

Using the receiver to play a source

After having properly connected a source (DVD, CD, VCR) to the receiver, you can partly control them through the receiver.

EN

Playing a DVD with the receiver

1. Connect a DVD player to the receiver (see connecting your receiver for details)

NOTE

To play Dolby Digital sound / DTS, the source must be connected to the receiver via the optical or coaxial terminal

2. Press **ON/ECO** to switch on the receiver
3. Select the DVD source.
4. Switch ON the DVD player and start playback
5. Switch ON your TV
6. Select the appropriate A/V channel on the TV (refer to your TV manual for details) until the image from the DVD player is displayed
7. Set the sound Mode if needed (see "Advanced sound control" for details)

Example 1:

To play 5.1 Dolby Digital surround sound
Press **SURR. MODE** button until "Dolby Digital" appears on the Display and all of the speakers' icons light up.

Example 2:

DVD: You may also need to select the Dolby Digital 5.1 on the DVD disc menu to have the digital surround enabled providing that the disc is encoded with Dolby Digital 5.1 (please refer to the DVD player and DVD disc instruction)

Example 3:

LD: You may need to select a different Audio Channel on your LD (refer to your LD player manual)

8. Adjust volume knob accordingly

Operating your Receiver

Operating the Radio

The receiver has a built-in tuner that allows for AM/FM radio function.

Manual tuning

1. Connect the FM and AM antenna accordingly (see "Connecting the Antenna" on page 5 section for details)

2. Press **ON/ECO** to switch on the receiver.

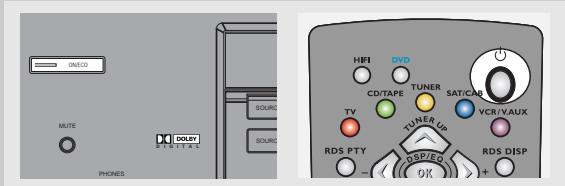

3. Press **SOURCE** keys to enter TUNER mode.

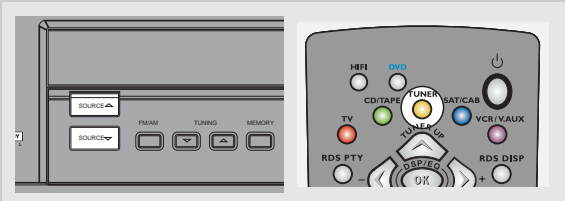

4- To select band, press the **BAND** button to toggle between AM/FM mode.

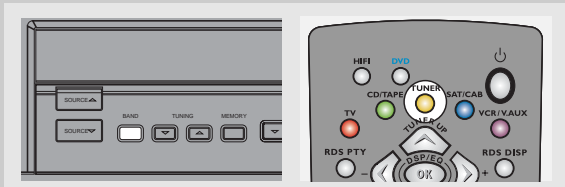

5- Tune the stations by pressing **TUNING UP** or **DOWN** repeatedly until the desired station is found. Alternatively, you can press and hold **TUNING UP** or **DOWN** for about one second to activate the automatic **SEARCH** function. In this mode the receiver will automatically tune frequencies until it finds a station

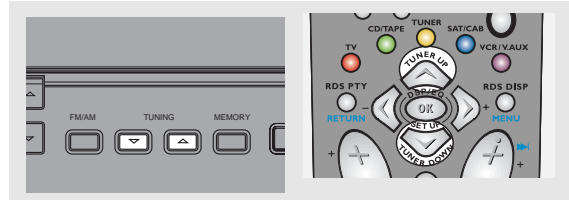

NOTE

1. If there is interference, modify the location of the antenna until the optimal sound is heard. TV and other electronic devices could be the cause of interferences so try to position the antenna away from them.

2. Weak signal can affect the "auto Search function". Adjust the antenna for better reception for more efficient search.

Select sound effect if needed by pressing Preset EQ or DSP sound (see "Advance sound section" for details)

Storing radio stations:

The receiver can store up to 40 radio stations in memory. You can enter every single radio station yourself or the receiver can store all available radio station automatically in an ascending order.

Automatic preset storing : (FM only)

1. Select the band by pressing **BAND**

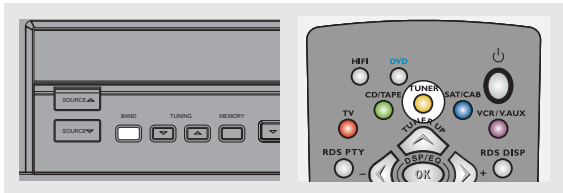

2- Press and hold **BAND** on the main unit for 3 seconds. "MEMORY" will be displayed in red and will blink during the automatic storing process.

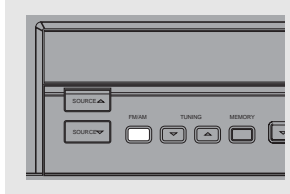

Radio frequencies will be scanned and radio station stored automatically. When all available radio stations are stored or if all 40 memory locations are full, the auto preset will stop.

NOTE

Weak signal can affect the "Automatic Preset Storing function" efficiency. Adjust the antenna for the best reception for more efficient search.

Operating your Receiver

EN

Manual preset

1. Select the band by pressing **BAND** repeatedly

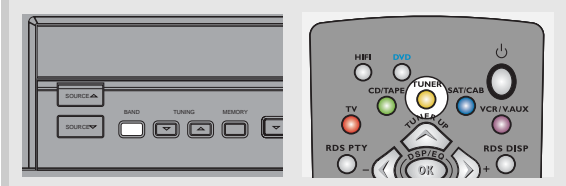

2. Tune to a radio station (see "Manual tuning" on page 16 above for details)

3. Press and hold **MENU** on the remote control. "MEMORY" will appear on the display

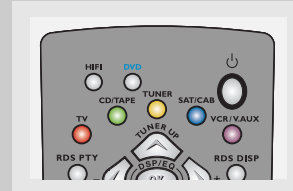

4. Select a preset station number.

5. Press **Menu** again to confirm selection.

Retrieving preset stations

1. Press **BAND** to select tuner mode

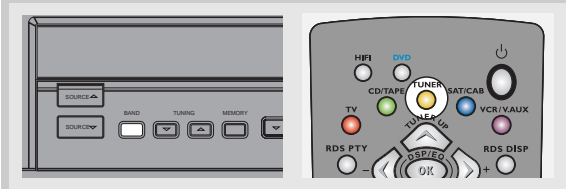

2. Press **MEMORY/MENU** button to enter preset setting mode (**MEMORY** icon shows on display), Press + **PR -** to select preset station.

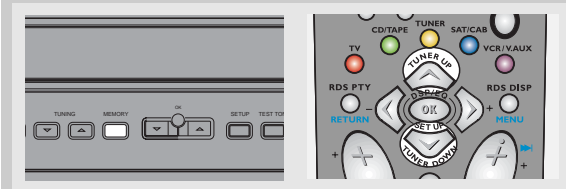

Operating your Receiver

RDS (Radio Data System) for FM Only

The **RDS** icon shows on display when RDS data are received. The following information may be available on certain stations:

- Frequency station,
- Station name,
- Program type,
- Clock,
- Radio text

Press **RDS MENU** on the remote control repeatedly to select the type of information you want to display.

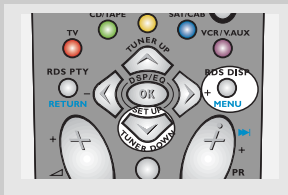

Search Station by Program Type

1. Press **RDS PTY** on the remote control repeatedly to display the desired program type.

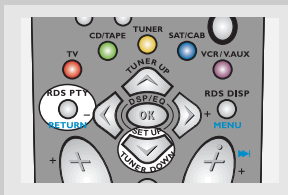

2. Press **TUNER UP** or **TUNER DOWN** on the main unit or the **TUNER UP** or **TUNER DOWN** arrows on the remote control to begin search.

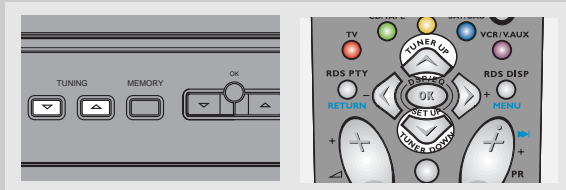

NOTE

NO PTY will be displayed if selected kind of program is not broadcasted

3. The search will stop when a station broadcasting the program type you have selected is found.

You can search for stations using one of the following program types:

- NEWS = news
- AFFAIRS = current affairs
- INFO = information
- SPORT = Sport
- EDUCAT = education
- DRAMA = series and plays
- CULTURE = religion or national culture
- SCIENCE = science and technology
- VARIED = miscellaneous
- POP M = pop music
- ROCK M = rock music
- MOR M = middle-of-the-road music, easy listening music
- LIGHT M = classical music
- CLASSICS = serious classical
- OTHER M = not classed
- WEATHER = weather, medical
- FINANCE = stock market reports
- CHILDREN = children's programs
- SOCIAL AFFAIR = sociology, history, geography, psychology, society
- RELIGION = any aspect of beliefs, faith & God or Gods
- PHONE IN = public forum by phone
- TRAVEL = feature and programs concerning travelling
- HOBBY = recreational activities & leisure
- JAZZ = jazz music
- COUNTRY = country music
- NATIONAL = national music
- OLDIES = oldies music
- FOLK = folk music
- DOCUMENTARY = documentaries

NOTE

The remote control selector must be set on *hifi*.



Sound Enhancement Systems

This receiver is equipped with several built-in sound enhancement systems.

Dolby Pro Logic

This surround system reproduces theater-like surround sound from Dolby-encoded software. The Pro Logic mode uses the built-in circuit to steer the Left, Center, Right and Surround channel audio signals and uses all five speakers' and an optional subwoofer to play decoded Dolby Pro Logic program source, such as TV and VCR.

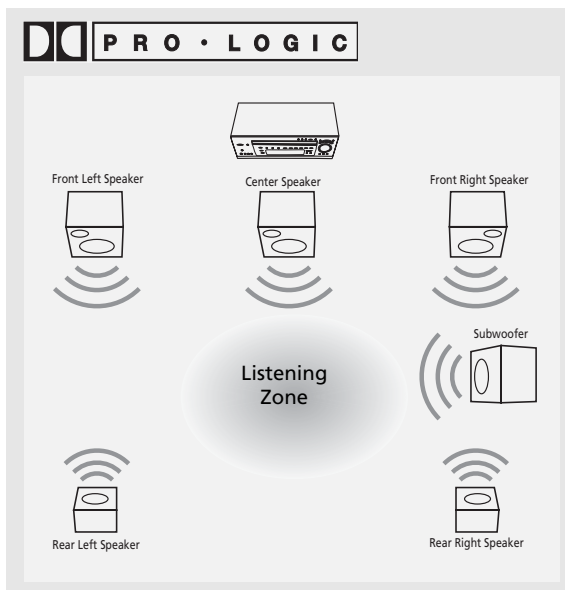

Advanced Sound Control

Dolby Digital

EN

The Dolby Digital mode lets you enjoy full digital surround from software processed in the Dolby Digital format. Dolby Digital provides better sound quality and more powerful presence than conventional Dolby Surround.

This unit is equipped with Dolby Digital 5.1-channel so that you can enjoy enhanced full digital surround sound. Being different from Dolby Pro Logic in which only four channels (Front Left, Front Right, Centre and Rear) are used, the new system provides stereo separation of the rear speakers (Rear-Right, Rear-Left). These 5 channels, together with the subwoofer channel for bass sounds (counted as 0.1 channel), constitute as 5.1-Channel (or 6 Channels) Input for Dolby Digital that brings you the most sophisticated sound enjoyment.

Digital Theater Systems (DTS)

DTS is a digital surround system which delivers six channels of master-quality, 20-bit audio. It offers five full-range channels plus a special low frequency effect (LFE) channel for subwoofer, resulting commonly know 5.1 channels. It can be applied with existing 5.1 speaker configurations.

DTS is available in DVD, SAT/CAB and CD mode.

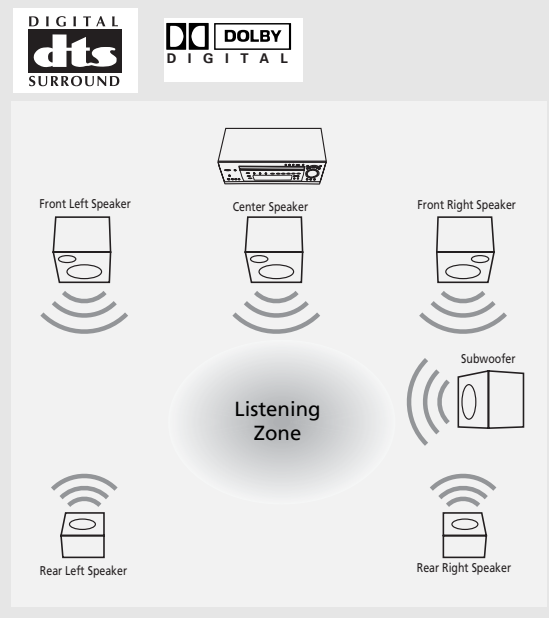

Advanced Sound Control

Stereo

The Stereo mode uses the two main channel outputs from the front speakers. Use this mode if you have connected the front speakers only.

DSP (Digital Sound Processor)

These digital sound effects resemble sounds in a real environment such as (STADIUM/CONCERT/THEATRE/ARENA/CHURCH/CLUB). DSP automatically converts analog audio signals to digital ones which enables you to adjust the sound without degrading the sound quality. Different modes will give you different feel of size and type of listening environment. (Not available in Dolby Digital (DVD))

Fine Setting of the Components

The receiver has pre-selected surround mode once you turn on the unit by pressing the **Source** Buttons (like DVD, SAT, CD) directly. The default surround modes for different components are listed in the table below.

If you decide to change the surround mode, you can press the **SURR MODE** repeatedly to toggle among the different surround mode choices and select the one you want.

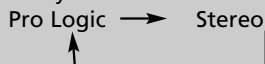

Source/ Input	If Digital Input (optical or coaxial) is selected	If Analog Input is selected
DVD	Dolby Digital/PRO LOGIC	PRO LOGIC
SAT	Dolby Digital/PRO LOGIC	PRO LOGIC
VCR	N/A	PRO LOGIC
V-AUX	N/A	PRO LOGIC
TV	Dolby Digital/PRO LOGIC	PRO LOGIC
CD	STEREO	STEREO
TAPE	N/A	STEREO
TUNER	N/A	STEREO

The receiver will keep the last selection in memory.

Input Signal Setting

The receiver defaults to the most convenient settings for your easiest use (see table).

If your connection is different from the default setting,

1. Select the source
2. Press **DIGITAL INPUT** button to toggle among optical/ coaxial/ analog to match your connection. Your selection will be stored automatically.

The selected source and input source will be displayed on the display as long as they are active, except for some temporary change of display (e.g. adjusting volume).

Digital Input

Select this setting to play digital signals from a DVD, CD, LD player, SAT or TV.

SOURCE	DEFAULT INPUT (as seen on display)
SAT	Analog (SAT/ ANL)
DVD	Analog (DVD/ ANL)
CD	Analog (CD/ ANL)
VCR	Analog (VCR/ ANL)
V-AUX	Analog (VAUX/ ANL)
FM/AM	Built-in Tuner
TAPE	Analog (TAPE/ ANL)
TV	Analog (TV / ANL)

NOTE

Digital input is only available for DVD, SAT, CD and TV

Analog Input

Select this setting to play analog signals from a cassette deck, VCR or turntable.

SOURCE	AVAILABLE INPUT
SAT	ANL/Optical/Coaxial
DVD	ANL/Optical/Coaxial
CD	ANL/Optical/Coaxial
VCR	ANL/ - / -
V-AUX	ANL/ - / -
TAPE	ANL/ - / -
TV	ANL/ Optical / -

Fine Setting of the Speakers

This receiver supports a wide range of speakers and subwoofers. For optimal surround sound enjoyment, you need to register the speaker selection settings of your audio system. If you buy this receiver with accompanied speaker package, then this step has been done for you.

Also, to make the surround sound more effective and suit the acoustic conditions in your listening room, you need to delay the signal from some of the speakers. Such channel delay compensates for center or surround speakers that are closer to listening position than the front speakers. You can make use of the **SETUP** button to adjust the speakers' relative loudness.

The TEST TONE button

You can adjust the relative loudness of the individual speakers by the **TEST TONE** button. In Dolby modes, press the button briefly. A short noise will be heard in the speakers one by one. The speaker having the noise at that moment will be shown in the display. You can listen to that speaker and press first the **LEVEL** button, then the **VOLUME UP/DOWN** ARROW on remote or the **VOLUME knob** to adjust the level.

Advanced Setting

Factory defaulted Advance setting indication from VFD

The receiver has defaulted the following distances:

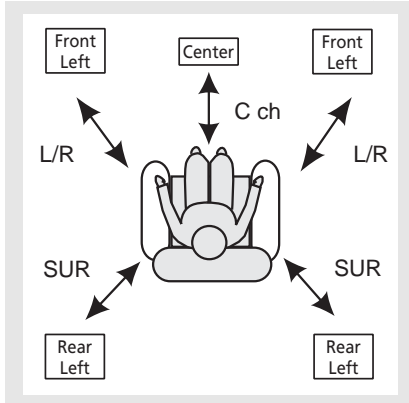

Front speakers (L/R) 4.5 m
 Center speaker (Cch) 4.5 m
 Rear speaker (SUR) 3 m

Advanced Sound Control

Speaker Configurations

You can also change the setup of the speakers by pressing the **SETUP** button until the display shows L/R SML or L/R LRG which enables you to set the size of the front speaker.

EN

Available Selections:

Front Speaker selection	Large/ Small
Center Speaker selection	Large/ Small/ None
Surround Speaker selection	Large/ Small/ None
Subwoofer selection	Yes/ No
Subwoofer Phase	+ / -
Front Speaker distance	1-12 m
Centre Speaker distance	0-12 m
Rear Speaker distance	0-12 m

Pressing **SETUP** button once, while the display is still showing L/R LRG, you may press the **OK** button to toggle among: front, center, surround, subwoofer, subwoofer phase and speakers' distance, sleep and dimmer setup. Set the speaker size or speakers' distance by pressing **UP/DOWN** ARROW button.

NOTE

- The sub-woofer selection will always be YES when the main speakers are set to small (SML).
- For the subwoofer phase setting, it will be affected by how you locate the subwoofer. Try both + and - settings and select the one that has better bass effect.
- If your unit comes with speakers, always set all speakers size to "small" to protect them and optimize the sound quality.
- To avoid the setting of invalid speaker combination which may cause bad sound quality, the speaker combination will be automatically changed to the default setting (L/R: small, Cent: small, Surr: small, Sub: Yes) if L/R speaker is changed from Large to Small. Under default setting, only Cent/Surr speaker could be changed to "No".

Advance Sound Control

Use a subwoofer to enjoy optimum sound.

- **Subwoofer Phase:** Try both settings and select the sound preferred.
- **Speaker distance:** For optimum surround experience measure the distance between the speaker and your favorite listening position.

1. Press **SETUP** once.

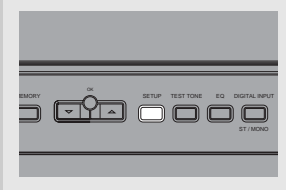

2. While the VFD display is showing L/R SML, press **UP/DOWN** ARROW button to select.

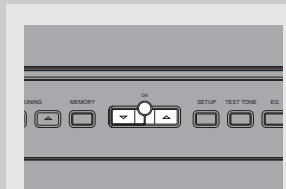

3. Press **OK** button once to move to the next speaker setting.

4. Repeat step 3 to set up the next speaker

5. When set up is done, wait for 5 seconds to automatically save your settings or press any source key to save your selection and set up mode.

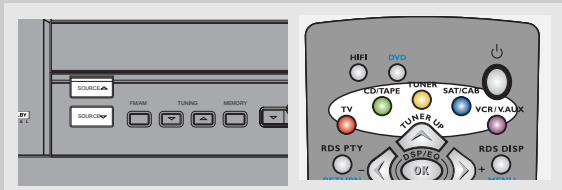

Speaker Icons

The receiver shows you the speakers' types and settings on the display with the following icons:

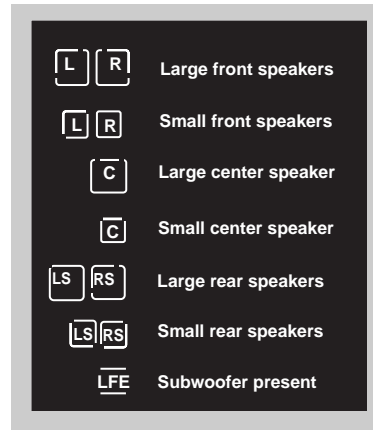

Displaying Program Formats

When a digital source is playing, the receiver will automatically switch to the proper surround mode and indicates on the speaker icons on the right-hand side of the display. (See diagram)

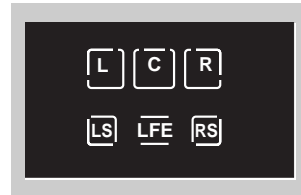

It is important to note, however, that not all Dolby Digital sources are encoded with the full complement of five channels plus LFE*. Speaker icons show how many and which speaker you have enabled (See "Fine Setting of the Speakers") and the letters inside the speaker icons show which channel is present in the source information. For example, the diagram shown means you have all the five speakers and subwoofer enabled and the digital sources you played have five channels plus LFE complemented.

* LFE stands for Low Frequency Effect. The indication "LFE" appears if the digital source contains LFE information. In this case, the bass signal will be delivered to the subwoofer, offering more dynamic deep bass sound effects. If the letter is flashing, the signal is either too weak or just gone.

Troubleshooting Tips

Receiver/Tuner Operation

ST indicator is off.

- Adjust the antenna.
- Press **DIGITAL INPUT/ST/MONO** button to insure you are not outputting in mono.

The signal is Mono. Severe hum or noise.

- The signal is too weak. Connect an external antenna.
- Adjust Antenna
- Reposition Antenna away from any electronics.

Remote Control Operation

The remote control does not operate the unit.

- Another source mode is selected on the remote. Press the correct Source Button.
- No batteries installed. (included with your system) Install the batteries before attempting to operate the remote. Be sure to match the + and - ends of each battery to the symbols shown in the remote battery compartment.
- The batteries are weak. Replace all batteries.
- The remote is not pointed at the remote control sensor on the main unit or there is an obstacle between the remote and the main unit.
- The remote control is too far from the main unit, move closer.

General

No audio.

- Make sure the speakers are connected.
- Check the input connections.
- Check the power cord connections.
- Make sure the MUTE signal on the front panel is off.
- Make sure the digital setting (optical, coaxial or analog) is correct.
- Check that the headphone is not inserted.

No audio from one channel.

- Check the speaker level setting.
- Check the speaker wire or external source cable connections.

Noise occurs when the TV is turned on.

- The TV is too close to the audio system.

Troubleshooting tips

EN

Specific instruments sound displaced.

- Check the connections between the receiver and the speakers if the sound does not match the video.
- Check if the video and audio cable are correctly inserted.

Cleaning the Exterior

- Disconnect the system from AC power before cleaning the exterior of the system with a soft dust cloth, or with a slightly damp leather chamois. Never use strong solvents.

Equipment Specifications:

AMPLIFIER SECTION:

All 5 channels: each 50W at 8 ohm. <10% THD @1 kHz
 Subwoofer channel: 50w at 8Ω , <10% THD @100 kHz
 Muting Attenuation: 65dB
 Frequency Response: 40Hz to 20kHz +/-3dB
 Signal to Noise Ratio: 65dB (Dolby digital mode)

VIDEO SECTION:

Input (Sensitivity/ Impedance):1Vp-p/ 75ohm
 Output (Level/ Impedance): 1Vp-p/ 75 ohm
 Frequency Response: 10Hz to 6MHz at +/- 3dB
 Signal to noise ratio: 40dB
 Crosstalk @3.58MHz: 40dB

AM TUNER SECTION:

Frequency Response: 80Hz – 2kHz +/-6dB
 Usable Sensitivity: 800uV/m @ S/N 20dB
 Signal to Noise: 38dB
 Image Ratio: 27dB @ 1000kHz
 IF Rejection: 35dB

FM TUNER SECTION:

Frequency Response: 40Hz – 15kHz +/-3dB
 Quieting: 24dBu
 Signal to Noise: 60dB(stereo) / 65dB(mono)
 Image Ratio: 40dB
 IF Rejection: 50dB

Dimensions:

Unit: 400D x 430W x 130H mm
 Speaker : 115D x 116W x 175H mm
 Subwoofer : 355D x 160W x 355H mm

Care and Maintenance

Disconnect the audio system from the power source before performing any maintenance.

Cleaning

Clean the exterior of the system using a soft dust cloth.

Important battery information

- Remove the batteries to avoid leakage if you do not use your remote control for more than one month.
- Discard leaky batteries immediately as leaking batteries may cause skin burns or other personal injuries.
- Dispose of batteries in the proper manner, according to provincial and local regulations.
- Any battery may leak electrolyte if mixed with a different battery type, if inserted incorrectly, if all batteries are not replaced at the same time, if disposed of in fire, or if an attempt is made to charge a battery not intended to be recharged.

Safety precautions

- Never open the cabinet under any circumstances. Any repairs or internal adjustments should be made only by a trained technician.
- Never operate this product with the cabinet removed.
- Do not touch the player with wet hands. If any liquid enters the player cabinet, take the player to a trained technician for inspection.
- This player uses a laser to read the data on the disc. The laser mechanism corresponds to the cartridge and stylus of a record player. Although this product incorporates a laser pick-up lens, it is completely safe when operated according to directions.
- Discs rotate at high speed inside the player. Do not use damaged, warped, or cracked discs.
- Do not touch the pick-up lens which is located inside the disc compartment. Also, to keep dust from collecting on the pick-up lens do not leave the compartment door open for an extended period of time. If the lens becomes dirty, clean it with a soft brush, or use an air blower brush designed for camera lenses.

Headset safety

- Do not play your headset at a high volume. Hearing experts warn against extended high-volume play.
- If you experience a ringing in your ears, reduce volume or discontinue use.
- You should use extreme caution or temporarily discontinue use in potentially hazardous situations.
- Even if your headset is an open-air type designed to let you hear outside sounds, don't turn up the volume so high that you are unable to hear what is around you.

Don't infringe

This product should only be used for the purposes for which it is sold, that is, entertainment, violating no copyright law. Any attempts to use this product for which it is not intended is unlawful and therefore not condoned by Thomson multimedia.

Free Manuals Download Website

<http://myh66.com>

<http://usermanuals.us>

<http://www.somanuals.com>

<http://www.4manuals.cc>

<http://www.manual-lib.com>

<http://www.404manual.com>

<http://www.luxmanual.com>

<http://aubethermostatmanual.com>

Golf course search by state

<http://golfingnear.com>

Email search by domain

<http://emailbydomain.com>

Auto manuals search

<http://auto.somanuals.com>

TV manuals search

<http://tv.somanuals.com>