

THOMSON
46, quai Alphonse Le Gallo
92648 Boulogne
Cedex FRANCE
55987200
www.thomson.net

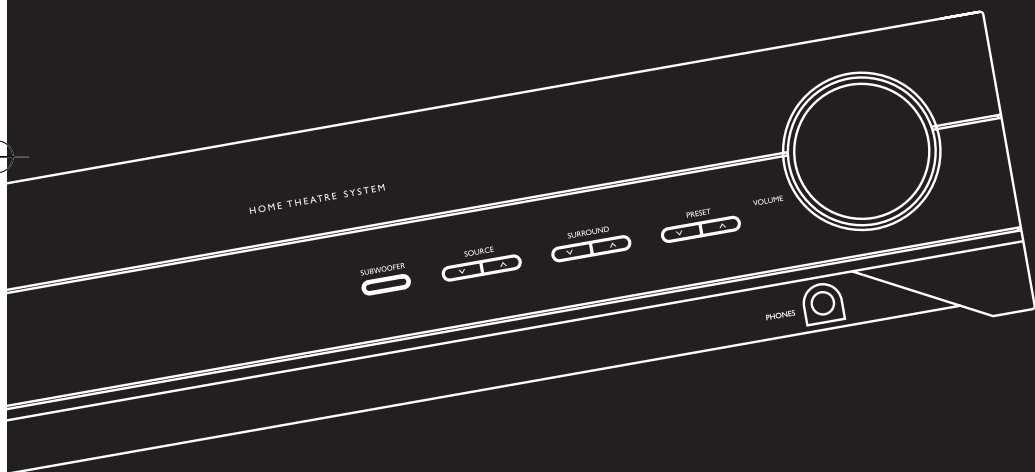

THOMSON

u s e r
m a n u a l



DPL590HT

It is important to read this instruction book prior to using your new product for the first time.

Safety Information

Rating Information: At bottom / back of the unit this unit comply with the existing requirements





In accordance with the rating plate of the unit, this unit complies with current standards concerning electrical safety and electromagnetic compatibility.



Please respect the environment Before throwing any batteries away, consult your distributor who may be able to take them back for specific recycling.



Have a Blast- Just Not in Your Eardrums Make sure you turn down the volume on the unit before you put on headphones. Increase the volume to the desired level only after headphone are in place.

 THE LIGHTNING FLASH AND ARROW-HEAD WITHIN THE TRIANGLE IS A WARNING SIGN ALERTING YOU OF "DANGEROUS VOLTAGE" INSIDE THE PRODUCT.	CAUTION RISK OF ELECTRIC SHOCK DO NOT OPEN	 THE EXCLAMATION POINT WITHIN THE TRIANGLE IS A WARNING SIGN ALERTING YOU OF IMPORTANT INSTRUCTIONS ACCOMPANYING THE PRODUCT.
SEE MARKING ON BOTTOM / BACK OF PRODUCT		

WARNING: TO PREVENT FIRE OR ELECTRICAL SHOCK HAZARD, DO NOT EXPOSE THIS PRODUCT TO RAIN OR MOISTURE.

For UK Only

CONNECT THE MAIN LEAD INTO A MAINS POWER SOCKET

POWER SUPPLY 230V. It must not be connected to D.C. mains.

Note; The mains lead of the set is fitted with a molded plug. If the mains socket are not compatible or if for any reason the plug is removed please follow the directions below. The molded plug cannot be rewired and if removed must be disposed of safely.

DO NOT under any circumstances plug the severed plug into any mains socket as this could result in electric shock.

Important: If the plug is removed, rewire the new plug as follow:

The wires in the mains plug are coloured in accordance to the following code:

BLUE = NEUTRAL/BROWN = LIVE

If the colours of the wires in the mains lead of this apparatus may not correspond with the coloured markings identifying the terminals in your plug, proceed as follows:

BLUE wire to the terminal coded N (Neutral) or coloured black.

BROWN wire to the terminal coded L (Live) or coloured red.

DO NOT make any connection to the terminal in the plug which is marked by the letter E or by the earth symbol or coloured green or green and yellow.

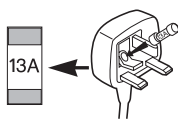

A fused plug must be fitted with a 3A fuse approved by ASTA or BS1362 and fuse covers must be always be securely replaced. If you set does not work, the fuse may be blown.

The descriptions and characteristics given in this document are given as a general indication and not as a guarantee. In order to provide the highest quality product possible, we reserve the right to make any improvement or modification without prior notice. The English version serves as the final reference on all products and operational details should any discrepancies arise in other languages.

Table of Content

Safety Information

Getting Started

Unpacking the Receiver	.2
Unpacking the Speakers	.2
Inserting Batteries into Remote Control	.3
Set Up and Maintenance of the Receiver	.3
Protect your Components from Overheating	.3
Connecting to Audio Components	.4
Digital Connection	.5
TV Connections	.5
Connecting Antennas	.5
Connecting the Speakers	.6
Connecting the Subwoofer	.6
Positioning your Speaker	.7
Front Speaker Placement	.7
Preferred Surround Placement	.8
Advanced Setting	.8
Test Tone / Channel Balance	.9
Connecting for Power	.9
Using Headphones	.9
Factory Setting	.9

Operating your Receiver

Receiver Controls	.10
Your Remote Control	.11
Display	.12
Switching On/Off	.13
Selection of Source	.13
Using the Remote to Control Additional Components	.14
Using the receiver to play a Source	.15
Operating the Radio	.16

Advanced Sound Control

Sound Enhancement Systems	.19
Fine Setting of Components	.21
Fine Setting of the Speakers	.22
Advanced Setting	.22

Troubleshooting Tips

Troubleshooting Tips	.24
Receiver/Tuner Operation	.24
Remote Control Operation	.24
General	.24
Cleaning the Exterior	.24

Care and Maintenance

Cleaning	.25
Important battery information	.25
Safety precautions	.25
Headset safety	.25
Don't infringe	.25
Equipment Specifications	.25

EN

Getting Started

Unpacking the Receiver

You should receive the following items:

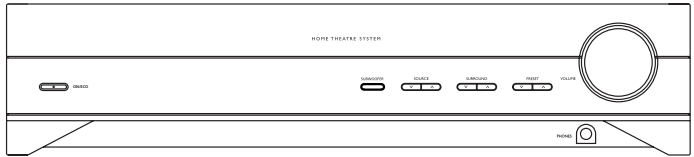

One receiver unit

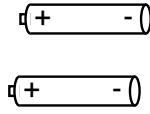

One pair of "AAA" batteries

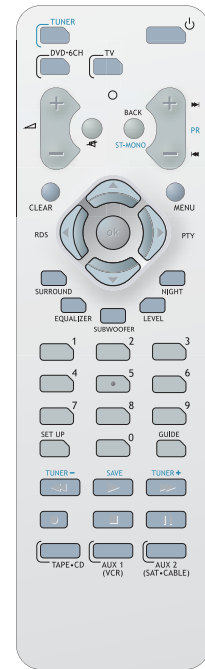

One Remote Control



One pig-tail antenna wire

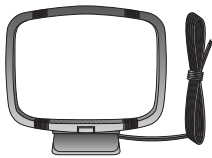

One external AM loop antenna

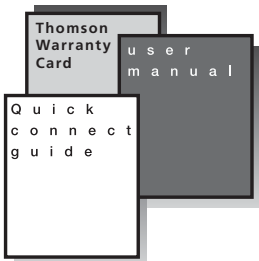

- one instruction book;
- Thomson Warranty Card;
- one Quick Connection Guide

Unpacking The Speakers

- one set of speakers including 1 set of left and right front speakers, 1 centre speaker, 1 subwoofer and 1 set of left and right rear speakers.

Front Speakers

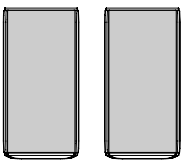

Center Speaker



Rear Speakers (Surround Sound)

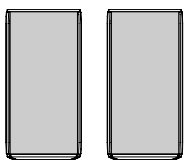

Subwoofer

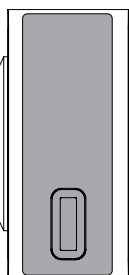

- 6 speaker wires including:



1 X green/grey striped wire for center speaker



1 X red/grey striped wire for front right speaker



1 X white/grey striped wire for front left speaker



1 X purple/grey striped wire for subwoofer



1 X blue/grey striped wire for rear left speaker



1 X gray/grey striped wire for rear right speaker

Getting Started

EN

Inserting Batteries into Remote Control

Insert two "AAA" (R03) batteries according to the + and - signs in the battery compartment. To use the remote control, point it directly at your receiver.

Install batteries as follows:

1. Remove battery compartment door by applying thumb pressure on battery door and then lift the door out and off the cabinet.
2. Insert 2 AAA batteries in the compartment and replace the compartment door.

Set up and Maintenance of the Receiver

Provide spaces for sufficient ventilation as indicated:

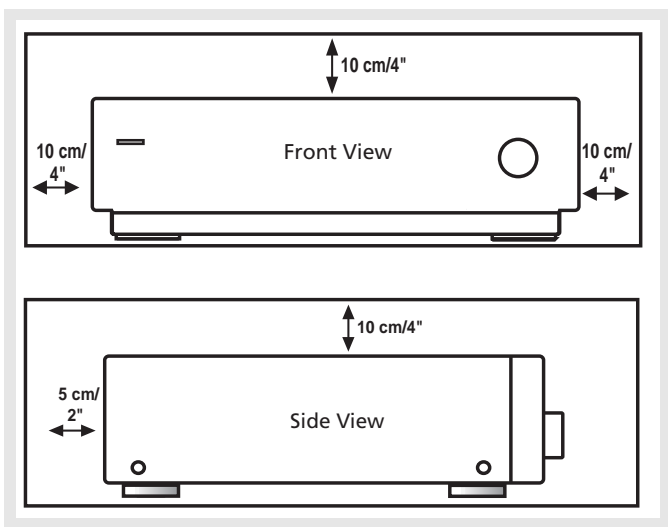

- Do not connect to the AC power cords until all connections are completed.
- Do not use your set immediately after transferring it from a cold place to a warm place: there is risk of condensation.
- Do not expose your set to water and excessively high temperatures.
- After having disconnected your set, clean the case with a soft cloth, or with a slightly damp leather chamois. Never use strong solvents.

Protect your Components from Overheating

- Do not block ventilation holes in any component. Arrange the components so that air can circulate freely.
- Do not stack components directly on top of each other.
- Do not place the unit near other components that generate heat such as heating vents.
- Allow adequate ventilation when placing your components in a stand.
- Place an amplifier near the top shelf of the stand so heated air rising from it will not affect other components. If you have a satellite receiver, you should place it on the top shelf.

Getting Started

Connecting to Audio Components

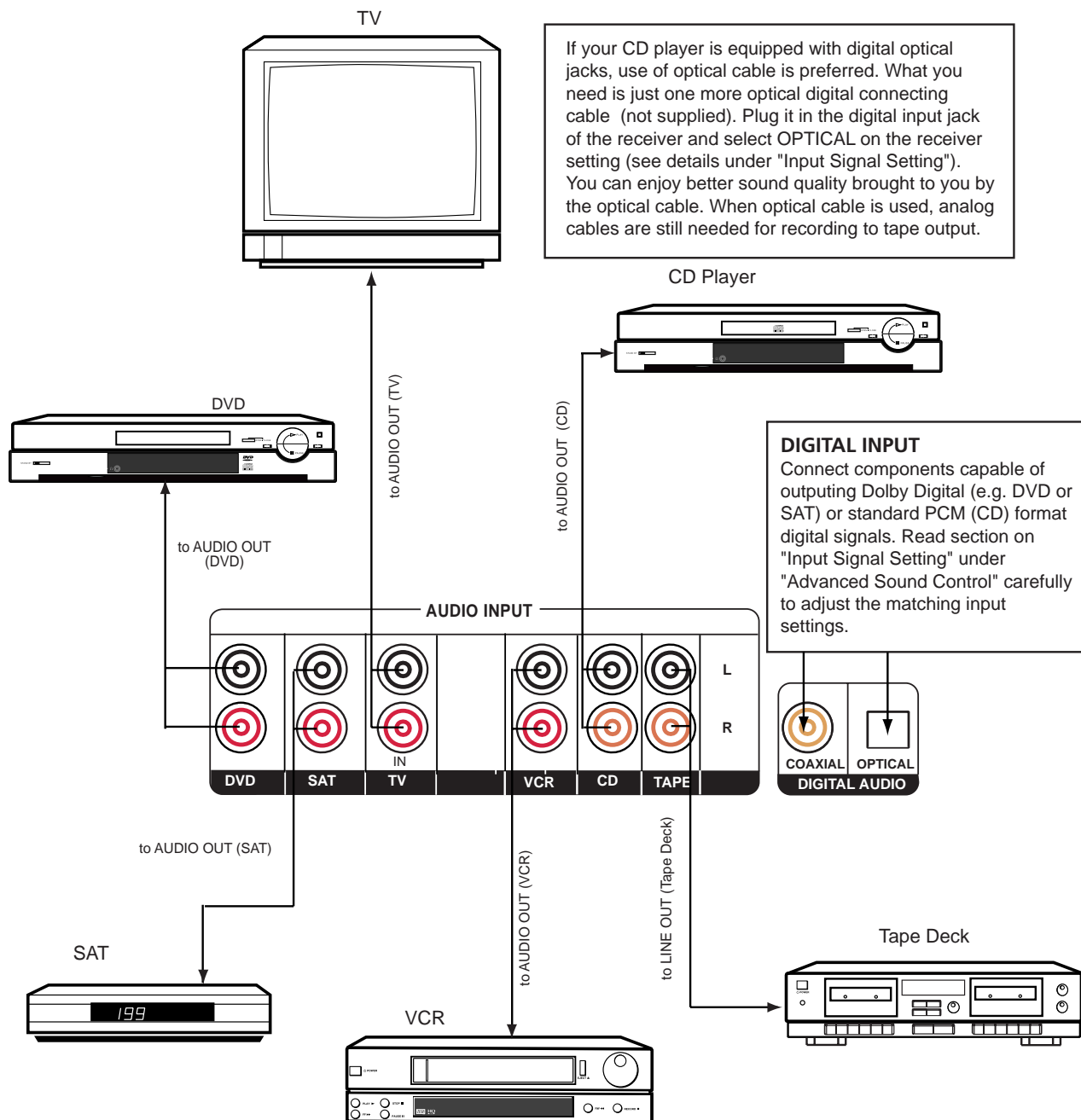

DIGITAL CONNECTION

If you have a SAT receiver DVD player or CD player with a digital output, you can make use of an optical digital cable (not supplied) or coaxial digital cable (not supplied) to carry the audio portion of the signal and enjoy Dolby Digital sound quality. One optical or coaxial cable is needed for each SAT receiver, DVD player or CD player. When optical or coaxial cable is used, the analog audio cables are still needed if recording through a tape or VCR is desired. This receiver provides one optical and one coaxial digital input for the connection of your components. Please connect your components (e.g. DVD, SAT or CD) to the appropriate digital inputs and press DIGITAL INPUT to select the corresponding digital input source.

Note: Optical and coax cables carry only the audio portion of the signal. A video connection must also be established for a SAT receiver and DVD player.

Digital Connections

Read instructions carefully when connecting components to the receiver.

Digital In Jacks can accept Dolby Digital (AC-3) or PCM signals when compatible components are connected.

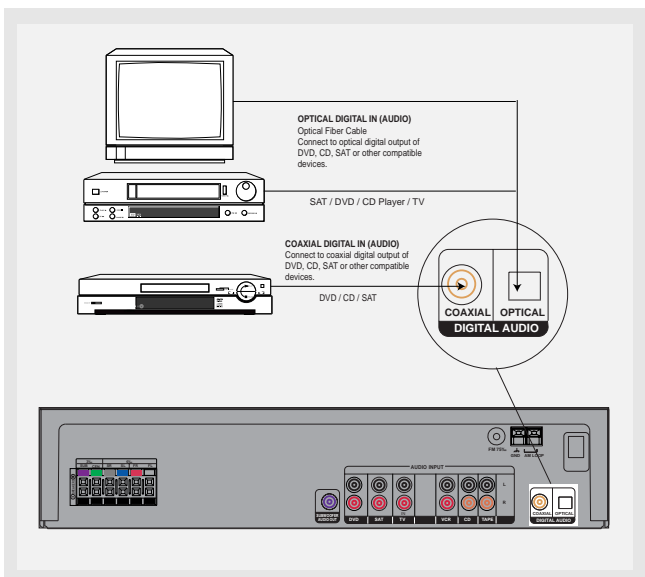

TV Connections

TVs with RF input may need a RF modulator (not included) for inputting audio signals.

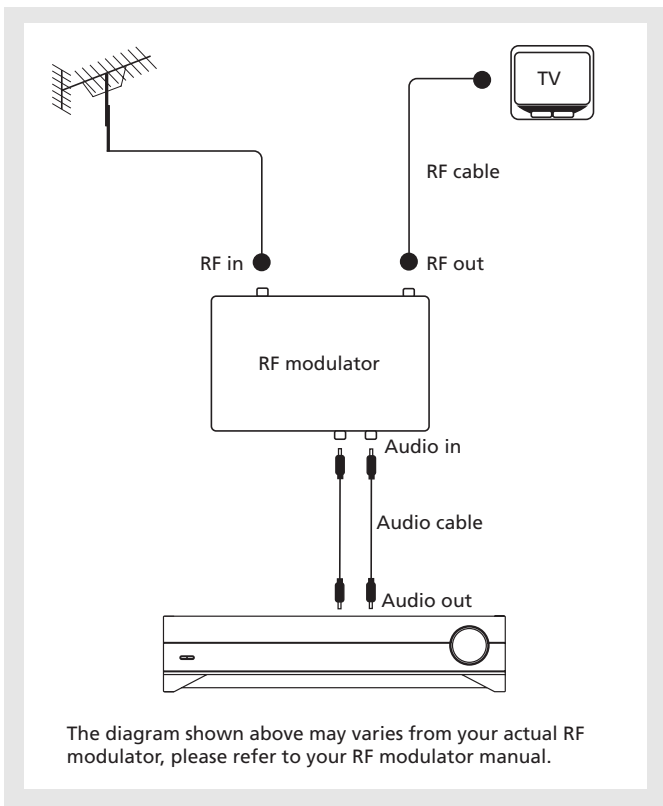

Getting Started

Connecting the Antennas

The AM and FM antennas connect to the AM and FM terminals on the system's back panel.

EN

They must be hooked up in order to receive clear reception.

AM Loop Antenna and FM Indoor Antenna

1. Uncoil the Antenna wire and locate the base end of the AM antenna.
2. Press down on the Antenna tab to open the terminal.
3. Inert the antenna wires into the terminal and release the tabs to secure the wires in place.

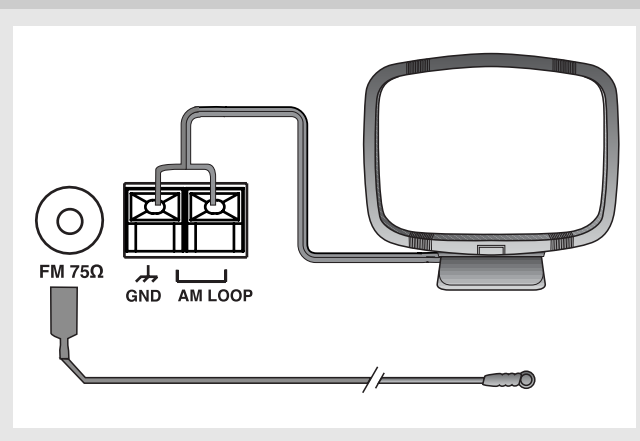

HINT

- For FM reception, extend antenna to its full length.
- For AM reception, rotate the antenna horizontally to get better reception.

Getting Started

Connecting the Speakers

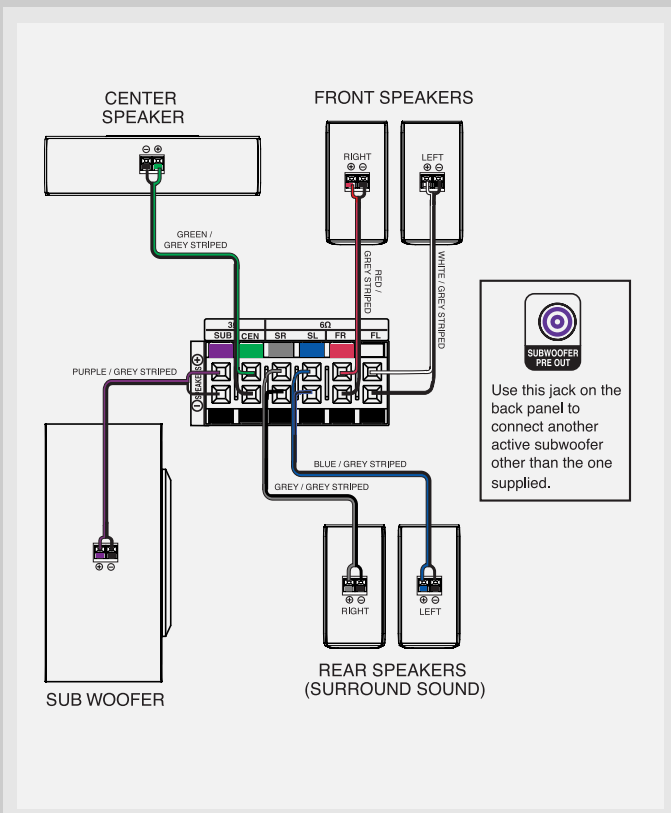

Speakers

There are 6 speakers equipped with the unit (2 front, 1 center, 2 rear, 1 subwoofer). In order to enjoy good surround effects, all six speakers need to be connected to the receiver.

At least two front speakers (left and right) are required. For better sound quality, Center speaker, rear speakers and Subwoofer should also be connected. Adding center and rear speakers will enhance surround effects. Adding a Subwoofer will increase bass response.

If you want to enjoy the full sound range, use the subwoofer with the speakers to maintain adequate bass signal.

Speaker wires

1 for each speaker, is needed for connection. Twist the stripped ends of speaker cord about 2/3 inch (15 mm). Press down on the tab to open the terminal and insert the wire. Release tab to lock wire in the terminal.

Antenna and Speaker Wire Connection

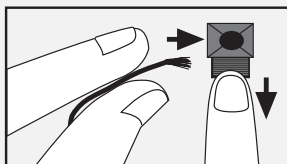

Push terminal tab down to insert wire.

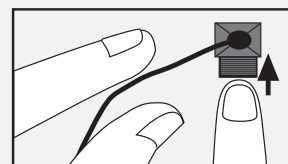

Release tab to lock wire in the terminal.

NOTE: Make sure the insulation is completely removed from the ends of the Antenna and speaker wires at all connection points.

To ease speaker connections, the speaker wires and the terminals are color-coded.

- White/Grey Striped (Front Left Speaker),
- Red/Grey Striped (Front Right Speaker),
- Green/Grey Striped (Center Speaker)
- Blue/Grey Striped (Rear Left Speaker).
- Grey/Grey Striped (Rear Right Speaker).
- Purple/Grey Striped (Subwoofer)

Connect the L, R speakers at the back of the speakers to the corresponding color on the receiver. Do the same for center (with green/black terminal), rear speaker and the subwoofer (with purple/black terminal).

Speaker Polarity

When connecting the speakers, make sure the polarities ("+" speaker wire to "+" on the receiver) of speaker wires and terminals are matched. If the wires are reversed, the sound will be distorted and will lack bass ("out of phase" effect).

Connecting the Subwoofer

Connect the subwoofer with the speaker wire (purple/black) provided.

This receiver offers a high flexibility for user to use a large variety of speakers and subwoofer. For more information please refer to section "Fine Setting of the Speakers" in "Advanced Sound Control" on page 22.

Positioning your speaker

① Left, Right (Front Speakers)

They carry primarily music and sound effects

② Center

In surround mode, the center speaker carries much of the dialogue as well as music and effects. It should be set between the left and right speakers.

③ Surround (Rear Speakers)

Their overall sound balance should be as close as possible to the front speakers. Proper placement is vital to establish an evenly distributed sound field.

④ Subwoofer

A subwoofer is designed to reproduce powerful low bass effects (explosions, the rumble of spaceships, etc.) which dramatically heightens involvement with the action on the screen. It is therefore recommended to connect subwoofers when small speakers are used.

Magnetic shielding

Speakers placed less than two feet from the TV set must be magnetically shielded in order to prevent picture distortion. Front and center speakers provided with this unit are magnetically shielded to protect your TV set.

It is not recommended to place the rear speakers near the TV set.

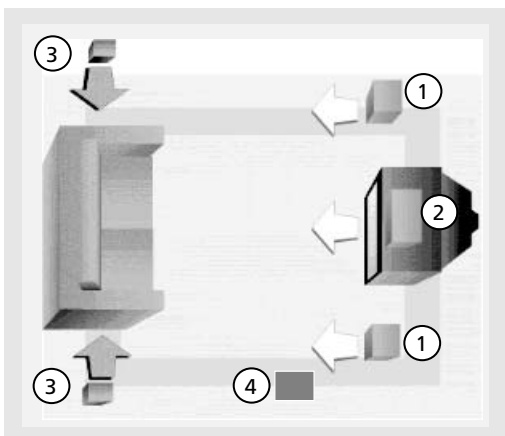

Courtesy Dolby Laboratories

Front Speaker Placement

Even if you can't duplicate this ideal home theater setup exactly, the suggestions for speaker placement that follow will help you get good results.

Getting Started

Alignment

Align the center speaker evenly with (A), or slightly behind (B), the left and right speakers, but not ahead of them.

EN

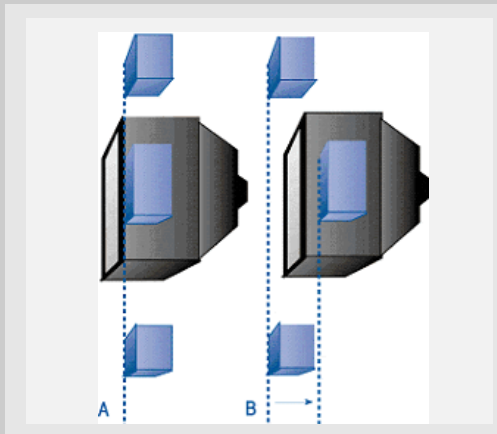

Courtesy Dolby Laboratories

Advanced Setting

Angle

Placing the left and right speakers to form a 45-degree angle with your favorite viewing position will duplicate the soundtrack mixer's perspective.

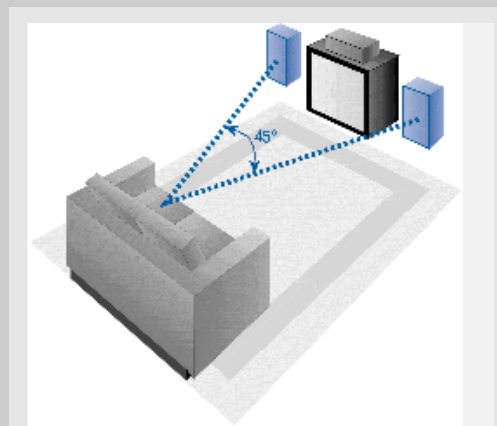

Courtesy Dolby Laboratories

Height

The three speakers should be as close as possible to the same height. This often requires placing the center speaker directly atop (A) or beneath (B) the TV set.

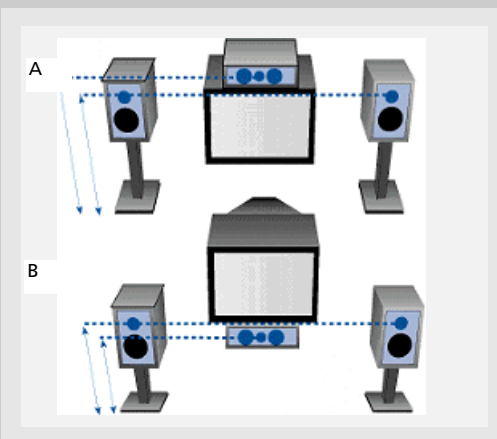

Courtesy Dolby Laboratories

Getting Started

Preferred surround placement

Location

If possible, place surround speakers to either side of the listening area, not behind it.

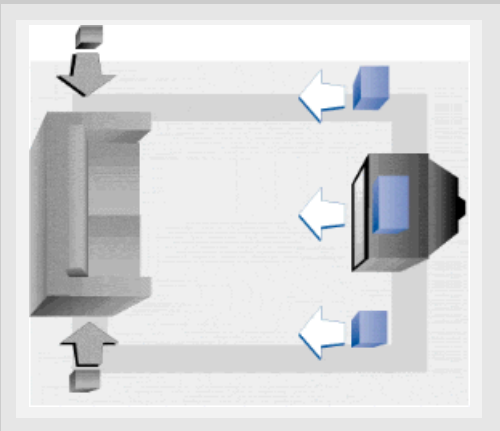

Courtesy Dolby Laboratories

Height

If space permits, install surrounds 2-3 feet above viewers. This helps to minimize localization effects.

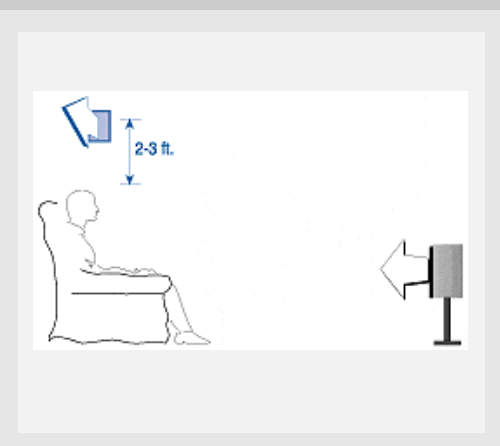

Courtesy Dolby Laboratories

Aiming

Aiming surrounds straight across the room, not down at viewers, helps create a more open, spacious surround sound field.

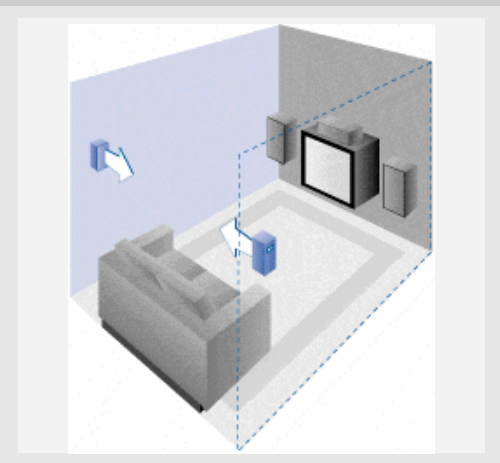

Courtesy Dolby Laboratories

Advanced Setting

Alternative Surround Placement

Rear wall

If rear wall mounting is the only choice, aim the speakers at each other (A), towards the front (B) or even towards the sidewalls (C, D). Experiment with placement until surround sounds seem to envelop you, rather than coming from behind you.

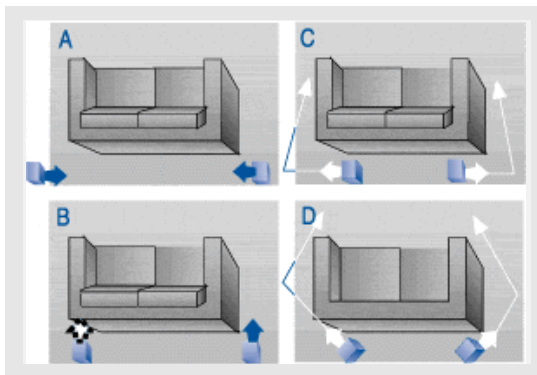

Courtesy Dolby Laboratories

No adjacent walls

Surrounds can go on stands facing each other to approximate the preferred sidewall mounting (A), or to the sides or rear of the viewing area aimed upwards. In the latter case, they can go right on the floor, or preferably, a few feet off the floor such as on end tables (B).

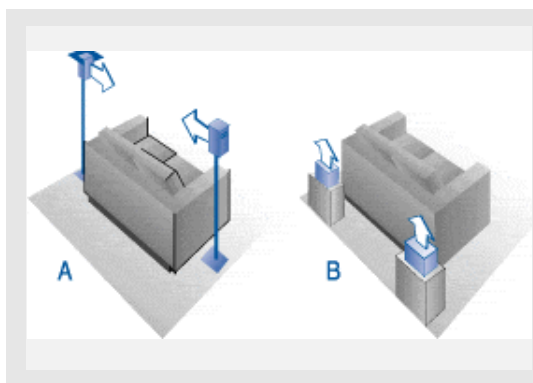

Courtesy Dolby Laboratories

Test Tone / Channel balance

Channel balance

Your receiver is equipped with a test signal generator for balancing the channels. As the signal "travels" from channel to channel, adjust the level controls until each channel plays at the same loudness level.

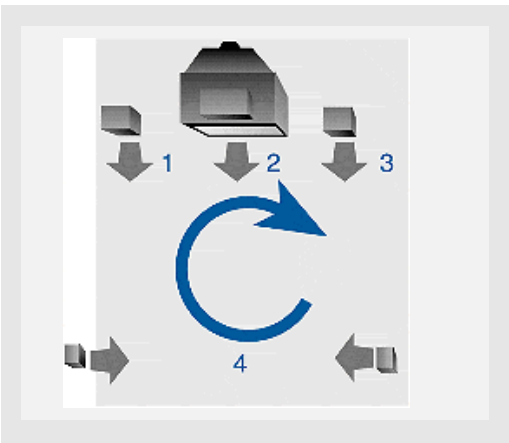

Courtesy Dolby Laboratories

Level adjustment & surround channel level expectation

Even though you adjust the surround channel to be as loud as the others on the test signal, you'll find that on actual program material the surround channel is usually much lower than the front. Don't be tempted to readjust the surround level; program producers use surround mostly for subtle atmospheric and ambience, and only rarely for special effects. A good surround mix doesn't call attention to itself; if it did, it would soon become distracting.

NOTE

The system is equipped with Dolby Digital, and manufactured under License from Dolby Laboratories.



DOLBY

D I G I T A L

Manufactured under license from Dolby Laboratories. "Dolby", "Pro Logic" and the double-D symbol are trademarks of Dolby Laboratories. Confidential Unpublished Works. © 1992-1997 Dolby Laboratories, Inc. All rights reserved.

D I G I T A L



SURROUND

Manufactured under license from Digital Theater Systems, Inc. US Pat. No. 5,451,942, 5,956,674, 5,974,380, 5,978,762 and other world-wide patents issued and pending. "DTS" and "DTS Digital Surround" are registered trademarks of Digital Theater Systems, Inc. Copyright 1996, 2000 Digital Theater Systems, Inc. All Rights Reserved.

Getting Started

Using Headphones

To listen privately through your audio system, use the PHONES jack on the receiver. However, make sure you turn down the volume before you put on the headphones. Increase the volume to the desired level after headphones are in place.

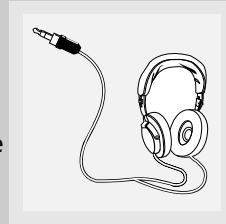

EN

Once headphones are connected, "HEADPHONE DOWN MIX 2 CHANNEL" will scroll on display. This feature automatically converts multi-channel speaker outputs to 2 channel stereo for your listening pleasure.

Hearing Comfort & Well-Being

- Do not play your headset at a high volume. Hearing experts advise against continuous extended play.
- If you experience a ringing in your ears, reduce volume or discontinue use.

Factory Setting

The unit is preset to the following settings when you first power the receiver up right out of the box:

Function = TUNER

Volume setting = 25

Bass & treble = 0 dB

EQ = FLAT

Speaker settings: Center, surr = YES

Subwoofer = STRONG

DRC = OFF

NOTE

STRONG SUBWOOFER setting makes the output level of subwoofer speaker to be stronger than normal Dolby setting. Adjust the SUBWOOFER setting by pressing the SUBWOOFER key to achieve the best bass performance.

Reset to Factory Settings

WARNING

All preset radio stations and surround sound setting will be lost after factory setting is restored.

You may restore factory setting with the following procedures:

1. Enter SAT mode.
2. Press **PRESET UP, PRESET DOWN, SOURCE UP** to reset the unit.

All preset stations will reset to FM87.5MHz and all receiver settings restore to default settings as described above.

Operating Your Receiver

Receiver Controls

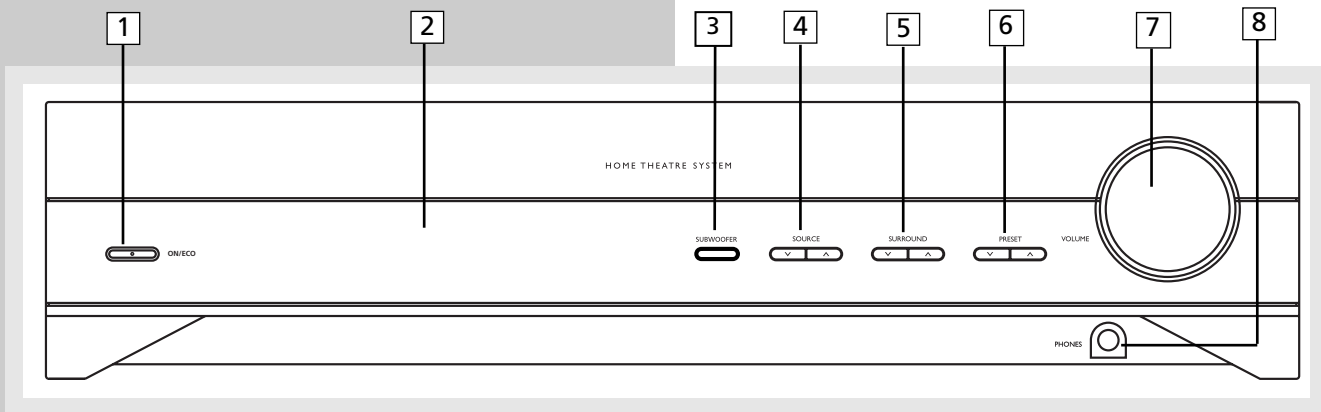

1. ON/ECO

Turns the unit on and off. When the system is turned on, the unit will go to the mode it was in before powered off.

2. Display

Displays current status of the receiver.

3. SUBWOOFER

Selects among subwoofer sound level. (SOFT SUBWOOFER, BALANCED SUBWOOFER, STRONG SUBWOOFER, POWERFUL SUBWOOFER)

4. SOURCE Buttons

Selects sound source. (DVD, Tuner, Tape, VCR, CD, TV and SAT)

5. SURROUND Buttons

Selects digital sound processor. (DOLBY PL II MOVIE, STEREO, DISCO, STADIUM, THEATER, JAZZ CLUB, ARENA, 3 STEREO, DOLBY PL EMULATION, DOLBY PL II MUSIC)

6. PRESET Buttons

Selects preset station in Tuner mode.

7. VOLUME

Increases and decreases volume level

8. PHONES

Plug your headphones (not supplied) into it for your private enjoyment. Speakers will be off when phones are inserted.

Operating Your Receiver

Remote Control

Please be sure you have inserted the batteries into the remote control (see relevant section on page 3.) You can test it by pressing any button.

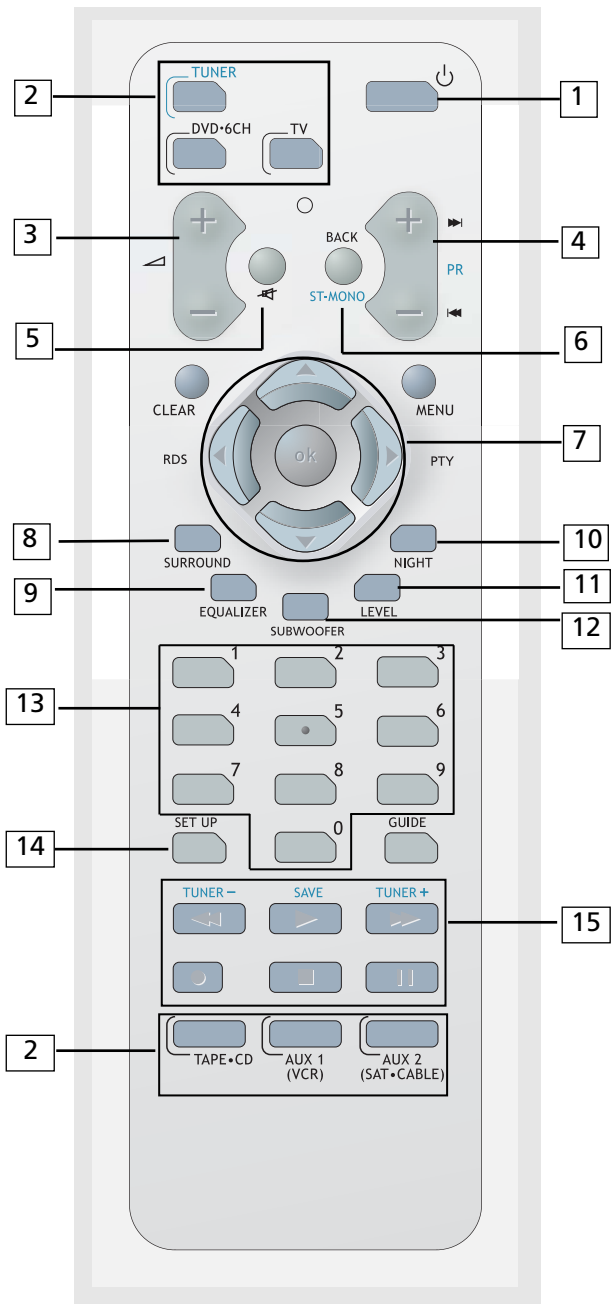

1. ON•OFF

Turns the receiver and other auxiliary components on and off. (see page 14 "Using the Remote to Control Additional Components").

2. Source Buttons

Selects various audio sources.

3. + / - (Volume Buttons)

Adjusts the volume level.

4. CH+ / CH- (Channel Buttons)

Selects programmed stations in TUNER mode.

5. MUTE

Mutes all audio output.

6. GO BACK / ST•MONO

- Selects between Stereo and Mono sound in Tuner mode.

7. Adjustment Buttons

- Press the Left or Right buttons to select among setting items in setup mode: SLEEP, DIMMER, SPEAKER DISTANCE, SPEAKER SETUP, and audio input source (ANALOG, OPTICAL / COAXIAL).
- Press the Up or Down buttons to adjust the values when the display shows the setup you want to change.
- Left / RDS* - In Tuner mode, press the Left arrow button to show Radio Data System (RDS) information if available. (Frequency station, Station name, program type, clock and radio text)
- Right / PTY* - In Tuner mode, press the Right arrow button to activate search by program type (PTY).

8. SURROUND

Selects among surround sound settings: DOLBY PL II EMULATION, DOLBY PL II MUSIC, DOLBY PL II MOVIE, STEREO, DISCO, STADIUM, THEATER, JAZZ CLUB, ARENA, 3 STEREO.

9. EQUALIZER

Selects among preset equalizer modes. (only available in stereo mode)

10. NIGHT

Selects among Night mode options (DRC OFF, SOFT and ON) which compresses the volume difference between normal voices and sounds such as explosions. (Available only during Dolby digital signal playback)

11. LEVEL

Speaker LEVEL setting and Test tone. Refer to "Advanced Sound Control" on pg. 22 for details.

12. SUBWOOFER

Selects among subwoofer output level (SOFT SUBWOOFER, BALANCED SUBWOOFER, STRONG SUBWOOFER, POWERFUL SUBWOOFER).

13. Number Buttons

Directly access a preset station in Tuner mode.

14. SETUP

Enters Setup mode. Use the Left and Right adjustment buttons to select among setup options. (SLEEP, DIMMER, FRONT SPK DISTANCE, CENTER SPK DISTANCE, SURROUND SPK DISTANCE, CENTER SPK ON/OFF, SURROUND SPK ON/OFF, DIGITAL INPUT).

15. Operation Buttons

In TUNER mode:

- Press the TUNER - and TUNER + keys to tune down or up the radio frequency.
- Press SAVE to activate the preset station saving and press to confirm preset station settings.
- PLAY, RECORD, STOP and PAUSE keys are only for easy control of external devices that are connected to your receiver such as CD, VCR, DVD, TAPE, etc.. The remote control currently operates most Thomson, RCA and GE products, but it can be programmed to operate devices from other manufacturers (For details, refer to "Using the Remote to Control Additional Components" on page 14.

NOTE

The remote control button CLEAR, MENU and GUIDE do not function for this receiver but can be used to control other RCA and Thomson products.

EN

Operating Your Receiver

Display



DVD / VCR / SAT / TUNER / TAPE / CD / TV

- An arrow points to the current source mode.

DIGITAL

- Dolby Digital audio input for signal format.

PRO LOGIC II

- Dolby Pro Logic II audio output format.

dts

- DTS audio output format.

FM / AM

- Radio band indicator in Tuner mode.

ST

- Tuner stereo signal detected.

OPT 1 2

- Optical digital input detected.

COAX 1 2

- Coaxial digital input detected.

TUNED

- Tuner station detected.



- Speaker Icons.
 - L - Front left speaker
 - C - Center speaker
 - R - Front right speaker
 - LS - Left surround (rear) speaker
 - RS - Right surround (rear) speaker
 - LFE - Subwoofer speaker

SLEEP

- Unit in Sleep mode.

MEMORY

- Unit is in Tuner Preset Station mode.

RDS

- Radio data system is activated.

KHz / MHz

- Tuner frequency unit.

Switching the unit on and off

- To switch on the receiver, press the **ON/ECO** button on the main unit once, or the  button on the remote control.

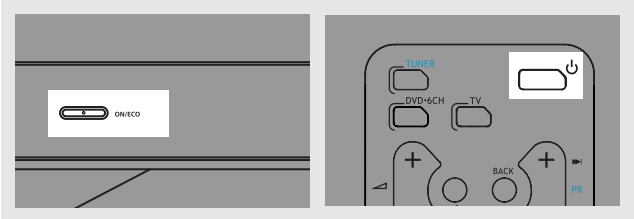

- Standby:** when the receiver is in tuner mode, press the **ON/ECO** button once to enter standby mode.

On the remote control, press the  button twice within 2 seconds if the receiver is not in Tuner source mode to enter standby mode.

To avoid entering standby mode when powering up the unit, do not press the  button twice within 2 seconds.

- The receiver draws a small amount of electricity when in standby mode. Unplugging the unit from the wall socket will stop the draw.

Selection of source

When one of the source button is pressed, the input corresponding to the name will be activated. The receiver acts as a switching device between all the sources that are plugged into it.

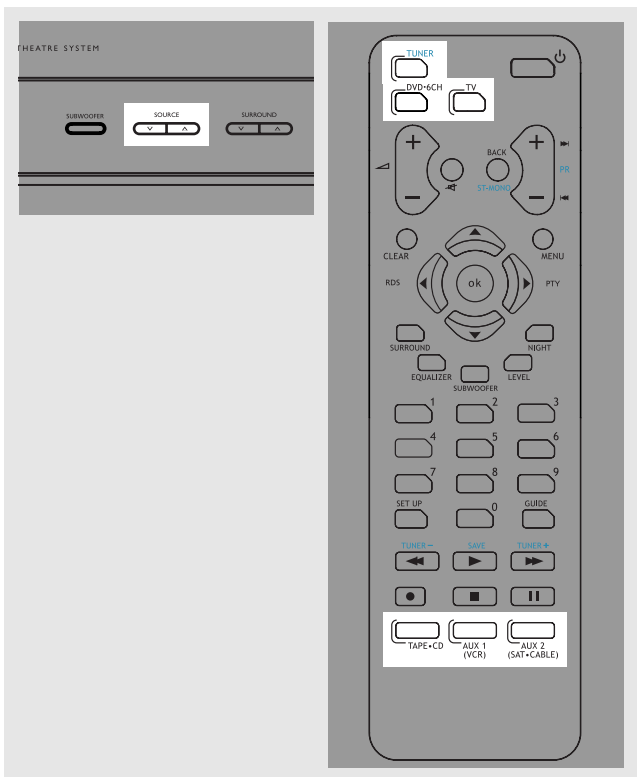

Operating Your Receiver

Example 1:

If you have connected a DVD player to the DVD input on the receiver, press the **SOURCE** buttons on the main unit repeatedly until DVD is selected or press **DVD•6CH** on the remote control to receive the sounds and images transmitted by the DVD.

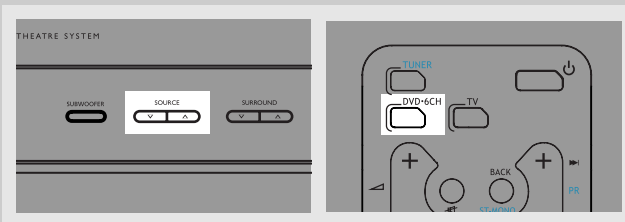
EN

Example 2:

Based on the example 1, the DVD is playing, if a VCR is connected to the VCR input of the receiver, press the **SOURCE** buttons on the main unit repeatedly until VCR is selected or press **AUX 1 (VCR)** on the remote control. The sound from the VCR source will replace the DVD.

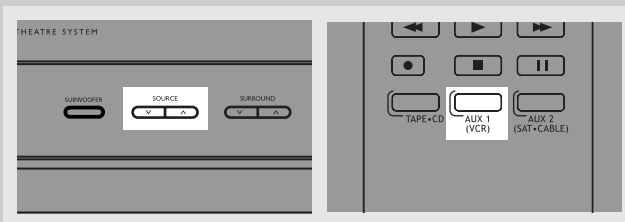

Operating your Receiver

You can connect up to 6 audio sources to this amplifier:

Source button (receiver front panel)	Corresponding connector (receiver back panel)
- DVD	DVD IN
- SAT	SAT IN
- TV	TV IN
- VCR	VCR IN
- CD	CD IN
- TAPE	TAPE IN
- FM/AM	built-in

An arrow points to the source name selected shown on the display.

Example: Press **DVD** to select DVD as the source to the amplifier.

NOTE

1. Your receiver has a built in tuner. Just connect the appropriate antenna to the back of the receiver and you will be able to listen to radio stations. (See details in Tuner section)
2. Other sources can be connected to the above standard source. Example: you can connect a LD into the DVD inputs.
3. Refer to the "Connecting To Audio-Visual Components" section for details on connection.

Using the Remote to Control Additional Components

You can use your remote to control most of Thomson branded VCRs, satellites, cable boxes or TVs. Press the corresponding source button on the remote control to operate options on other components.

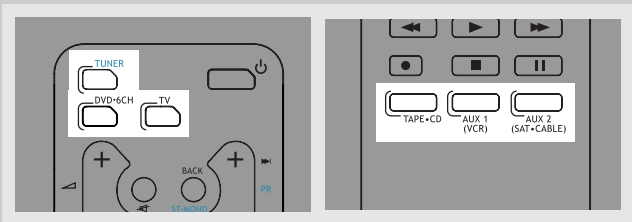

NOTE

The remote control can only operate Thomson brand products.

Volume Punchthrough

NOTE

Volume punchthrough can be done in all non-Tuner modes.

By default, the \triangleleft +/- and **MUTE** \triangleleft buttons will only control the receiver, regardless which mode (TV, VCR, etc) the receiver is in. By programming the volume punchthrough function, you can also control the volume of the TV.

NOTE

Controlling the TV volume can only be done in non-Tuner modes.

To activate the volume punchthrough function, follow the procedures below:

1. Press and hold the \triangleleft - button.
2. While holding down the \triangleleft - button, press one of the source buttons to select the source where you want to control TV volume at. (**DVD, TV, VCR** or **SAT•CABLE**)
3. Continue holding down the \triangleleft - button and press the **TV** button once.
4. Release all buttons.

You should now be able to control TV volume and mute at the selected device.

HINT

*To return to controlling receiver volume and mute again, follow the steps above but press **TUNER** instead of **TV** in step 3.*

HINT

If batteries are removed from the battery compartment of the remote control, the volume and mute control in all source modes will be the receiver volume and mute control except in TV mode.

Using the receiver to play a source

After having properly connected a source (DVD, CD, VCR) to the receiver, you can partly control them through the receiver.

Playing a DVD with the receiver

1. Connect a DVD player to the receiver (see connecting your receiver for details).

NOTE

To play Dolby Digital sound, the source must be connected to the receiver via the optical or coaxial terminal

Operating your Receiver

EN

2. Press **ON/ECO** on the main unit or press  on the remote control to switch on the receiver.
 3. Press the **SOURCE** buttons on the main unit or **DVD•6 CH** on the remote control to select the DVD source.
 4. Switch ON the DVD player and start playback.
 5. Switch ON your TV.
 6. Select the appropriate A/V channel on the TV (refer to your TV manual for details) until the image from the DVD player is displayed.
 7. Set the sound Mode if needed (see "Advanced sound control" for details).
- Example 1:**
To play Dolby Prologic II Movie sound
Press the **SURROUND** buttons until "Dolby PL II MOVIE" appears on the Display and all of the speaker" icons light up.
- Example 2:**
LD: You may need to select a different Audio Channel on your LD (refer to your LD player manual).
8. Adjust the volume knob accordingly.

Operating your Receiver

Operating the Radio

The receiver has a built-in tuner that allows for AM/FM radio function.

Manual tuning

1. Connect the FM and AM antenna accordingly (see "Connecting the Antenna" on page 5 section for details)
2. Press **ON/ECO** on the main unit or  on the remote control to switch on the receiver.

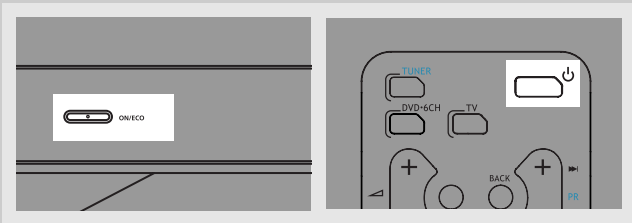

3. Press the **SOURCE** buttons on the main unit until the tuner mode is selected or press **TUNER** on the remote control.

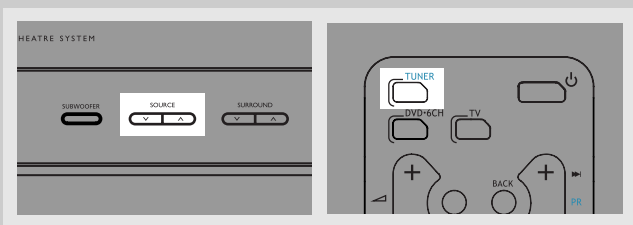

4. To select between FM and AM band, press the **TUNER** button repeatedly.

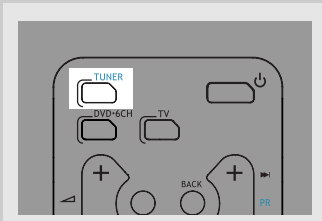

5. Tune to a station by pressing **TUNER -** or **TUNER +** repeatedly until the desired station is found.

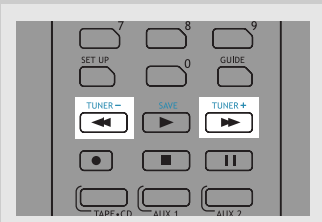

Automatic Tuning

Press and hold **TUNER -** or **TUNER +** for about one second to activate the automatic SEARCH function. The receiver will automatically tune frequencies until it finds a station.

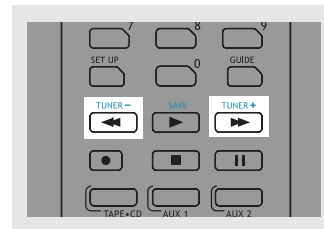

NOTE

1. If there is interference, move the location of the antenna until the optimal sound is heard. TV and other electronic devices could be the cause of interferences so try to position the antenna away from them.
2. Weak signal can affect the "auto Search function". Adjust the antenna for better reception and for a more efficient search.

Select a sound effect if needed by pressing the **SURROUND** button. (see "Advance sound section" for details).

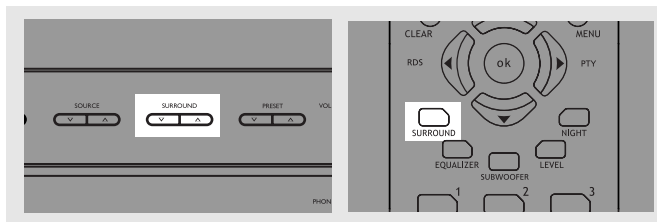

Selecting Mono or Stereo Sound

Press the **ST•MONO** button on the remote control to toggle between mono and stereo sound in FM tuner mode (when available).

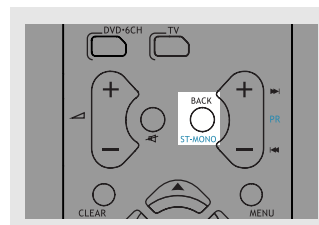

Storing radio stations

The receiver can store up to 40 radio stations in memory. You can enter every single radio station yourself or the receiver can store all available radio stations automatically in an ascending order.

Automatic preset storing : (FM only)

1. In Tuner mode, select the FM band by pressing **TUNER** on the remote control.

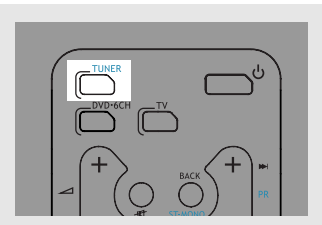

2. Press and hold the **TUNER** button on the remote control for 3 seconds. "MEMORY" will be displayed in red and will blink during the automatic storing process.

Radio frequencies will be scanned and radio stations will be stored automatically. When all available radio stations are stored or if all 40 memory locations are full, the auto preset will stop.

NOTE

A Weak signal can affect the "Automatic Preset Storing function" efficiency. Adjust the antenna for the best reception, and a more efficient search.

Manual preset

1. Select FM or AM band by pressing **TUNER** repeatedly.
2. Tune to the radio station to be stored. (see "Manual tuning" on page 16 above for details)

Operating your Receiver

3. Press the **SAVE** button on the remote control. "MEMORY" will flash and a preset number will be shown on the display.

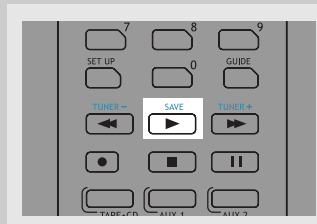

EN

4. While MEMORY is still flashing on the display, press **PR** ◀ or **PR** ▶ on the remote control to select the desired preset memory location.

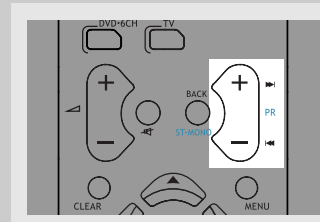

5. Press the **SAVE** button on the remote control to store frequency in selected preset location.
6. Repeat steps 1-5 to store other frequencies.

Retrieving preset stations

1. Press **TUNER** on the remote control to select tuner mode.
2. Press the **PRESET** buttons on the main unit or the **PR** ◀ or **PR** ▶ buttons on the remote control to select the preset station.

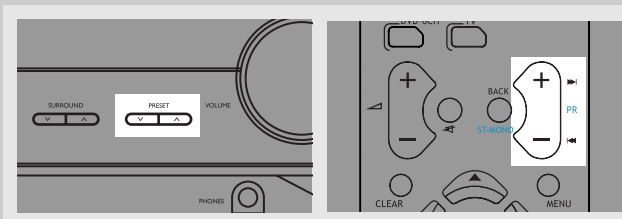

Operating your Receiver

RDS (Radio Data System) for FM Only

The **RDS** icon shows on display when RDS data are received. The following information may be available on certain stations:

- Frequency station,
- Station name,
- Program type,
- Clock,
- Radio text

Press **RDS** on the remote control repeatedly to select the type of information you want to display.

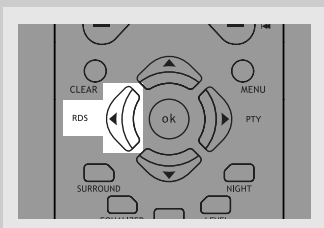

Search Station by Program Type

1. Press **PTY** on the remote control repeatedly to display the desired program type.

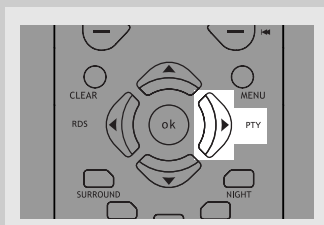

2. Press **TUNER -** or **TUNER +** on the remote control to begin search.

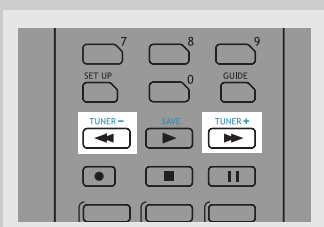

NOTE

NO PTY will be displayed if selected kind of program is not broadcasted

3. The search will stop when a station broadcasting the program type you have selected is found.

You can search for stations using one of the following program types:

- NEWS = news
- AFFAIRS = current affairs
- INFO = information
- SPORT = Sport
- EDUCAT = education
- DRAMA = series and plays
- CULTURE = religion or national culture
- SCIENCE = science and technology
- VARIED = miscellaneous
- POP M = pop music
- ROCK M = rock music
- MOR M = middle-of-the-road music, easy listening music
- LIGHT M = classical music
- CLASSICS = serious classical
- OTHER M = not classed
- WEATHER = weather, medical
- FINANCE = stock market reports
- CHILDREN = children's programs
- SOCIAL AFFAIR = sociology, history, geography, psychology, society
- RELIGION = any aspect of beliefs, faith & God or Gods
- PHONE IN = public forum by phone
- TRAVEL = feature and programs concerning travelling
- HOBBY = recreational activities & leisure
- JAZZ = jazz music
- COUNTRY = country music
- NATIONAL = national music
- OLDIES = oldies music
- FOLK = folk music
- DOCUMENTARY = documentaries

Sound Enhancement Systems

This receiver is equipped with several built-in sound enhancement systems.

Dolby Digital

The Dolby Digital mode lets you enjoy full digital surround from software processed in the Dolby Digital format. Dolby Digital provides better sound quality and more powerful presence than conventional Dolby Surround.

This unit is equipped with Dolby Digital 5.1-channel so that you can enjoy enhanced full digital surround sound. Being different from Dolby Pro Logic in which only four channels (Front Left, Front Right, Centre and Rear) are used, the new system provides stereo separation of the rear speakers (Rear-Right, Rear-Left). These 5 channels, together with the subwoofer channel for bass sounds (counted as 0.1 channel), constitute as 5.1-Channel (or 6 Channels) Input for Dolby Digital that brings you the most sophisticated sound enjoyment.

Dolby Pro Logic II

The Pro Logic II mode uses the built-in circuit to steer the Left, Center, Right and Surround left and right channel audio signals and uses all five speakers to play both stereo and Dolby Pro Logic program source, such as TV and VCR. Dolby Pro Logic II includes Dolby Pro Logic II Movie, Dolby Pro Logic II Music and Dolby Pro Logic Emulation.

You can use this mode with any stereo program source (such as VCR/SAT) to enjoy multi-channel sound experience.



Advanced Sound Control

Digital Theater Systems (DTS)

EN

DTS is a digital surround system which delivers six channels of master-quality, 20-bit audio. It offers five full-range channels plus a special low frequency effect (LFE) channel for subwoofer, resulting commonly know 5.1 channels. It can be applied with existing 5.1 speaker configurations.

DTS is available in DVD, SAT/CAB, TV and CD mode. (When digital cable is connected)

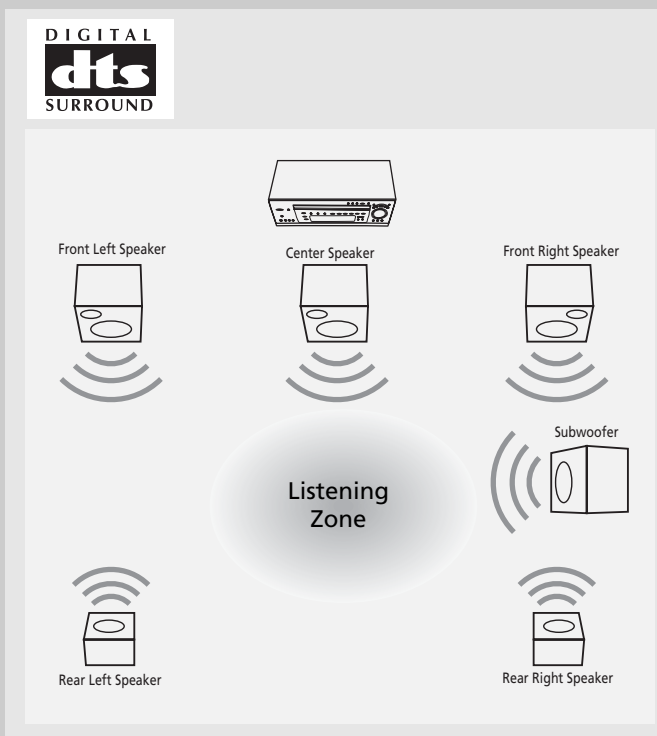

Advanced Sound Control

Dolby 3 Stereo

The 3 Stereo mode will redirect the Surround signals to the front left and right speakers when only the front and center speakers are used.

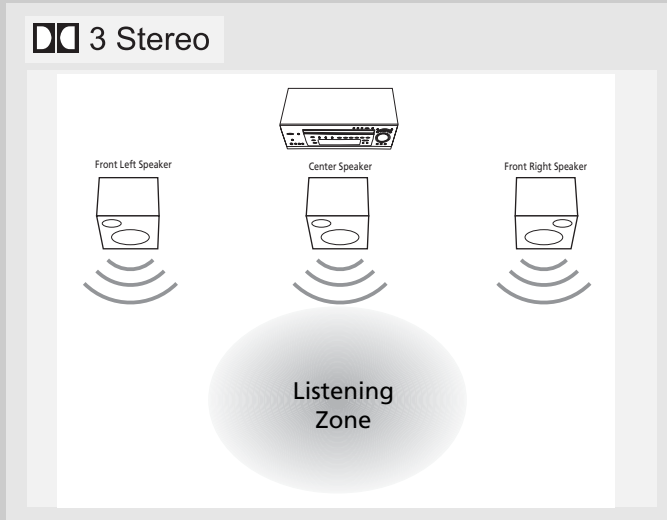

Stereo

The Stereo mode uses the two main channel outputs from the front speakers. Use this mode if you have connected the front speakers only.

DSP (Digital Sound Processor)

These digital sound effects resemble sounds in a real environment such as (DISCO / STADIUM / THEATER / JAZZ CLUB / ARENA). DSP automatically converts analog audio signals to digital ones which enables you to adjust the sound without degrading the sound quality. Different modes will give you different feels of size and types of listening environment.

Night Mode

By using Dynamic Range Control technology, you can enjoy enhanced Dolby Digital sound quality at night without interrupting your roommates or neighbors. Night Mode will compress the difference between normal voices and sounds such as explosions, while still enjoying a Dolby Digital enable component (DVD, SAT). Night Mode can be activated by pressing the **NIGHT** button on the remote control. DRC OFF (Default) appears on the display. While DRC OFF (Default) is still on the display, continue to press the **NIGHT** button to toggle and select the desired night mode. There are three modes (DRC OFF, SOFT, ON) for you to choose the extents of compression.

NOTE

Night mode is available only with Dolby Digital playback.

Dynamic Bass Amplified System (dBas)

With "Dynamic Bass Amplified System" (dBas), the discrete amplifier is located in the receiver so the subwoofer keeps the power needed to reproduce powerful effects.

4 settings are available: SOFT, BALANCED, STRONG and POWERFUL.

Press the **SUBWOOFER** button to toggle the subwoofer (dBas) effects level according to your needs.

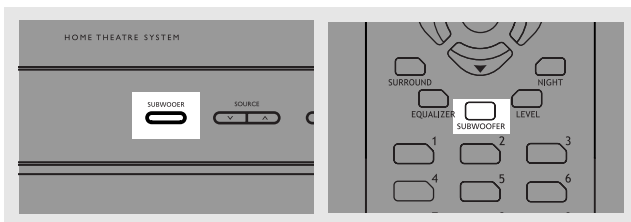

Fine Setting of the Components

The receiver can be directly turned on by pressing the **DVD•6CH / SAT•CABLE / TV / CD•TAPE / VCR / TUNER** buttons on the remote control, which also selects the best surround sound mode. The default surround modes for different components are listed in the table below. If you decide to change the surround mode, you can press the **SURROUND** button repeatedly to toggle among the different surround mode choices and select the one you want.

DOLBY PL II MUSIC => DOLBY PL EMULATION => 3
STEREO => ARENA => JAZZ CLUB => THEATER =>
STADIUM => DISCO => STEREO => DOLBY PL II MOVIE

Source/ Input	If Digital Input (optical or coaxial) is selected	If Analog Input is selected
DVD	Dolby Digital	PRO LOGIC
SAT	Dolby Digital	PRO LOGIC
VCR	N/A	PRO LOGIC
TV	Dolby Digital	PRO LOGIC
CD	STEREO	STEREO
TAPE	N/A	STEREO
TUNER	N/A	STEREO

The receiver will keep the last selection in memory.

NOTE

If linear PCM source (CD), format will be Dolby Prologic even with Digital Input.

Input Signal Setting

The receiver defaults to the most convenient settings for your easiest use (see table).

If your connection is different from the default setting,

1. Select the source
2. Press the **SETUP** button to show setup options.
3. Press the Left or Right adjustment buttons until ANALOG is displayed.
4. Press the Up or Down arrow buttons to select among optical/ coaxial/ analog to match your connection. Your selection will be stored automatically.

The selected source and input source will be displayed on the display as long as they are active, except for some temporary change of display (e.g. adjusting volume).

Advanced Sound Control

Digital Input

Select this setting to play digital signals from a DVD, CD, LD player, SAT or TV.

EN

SOURCE	DEFAULT INPUT (as seen on display)
SAT	Analog (SAT/ ANL)
DVD	Analog (DVD/ ANL)
CD	Analog (CD/ ANL)
VCR	Analog (VCR/ ANL)
FM/AM	Built-in Tuner
TAPE	Analog (TAPE/ ANL)
TV	Analog (TV / ANL)

NOTE

Digital input is only available for DVD, SAT, CD and TV

Analog Input

Select this setting to play analog signals from a cassette deck, VCR or turntable.

SOURCE	AVAILABLE INPUT
SAT	Analog / Optical / Coaxial
DVD	Analog / Optical / Coaxial
CD	Analog / Optical / Coaxial
VCR	Analog / - / -
TAPE	Analog / - / -
TV	Analog / Optical / -

Advanced Sound Control

Fine Setting of the Speakers

All the basic settings have already been pre-set for the speakers included in the box.

Also, to make the surround sound more effective and suit the acoustic conditions in your listening room, you may need to delay the signal coming from some of the speakers. Channel delay compensates for center or surround speakers that are closer to the listening position than the front speakers. You can make use of the **SETUP** button to adjust the speakers' relative loudness.

Testing Speaker Loudness

You can listen to the loudness of the individual speakers.

1. Press and hold **LEVEL** on the remote control. A short noise will be heard in the speakers one by one. The speaker having the noise at that moment will be shown in the display.

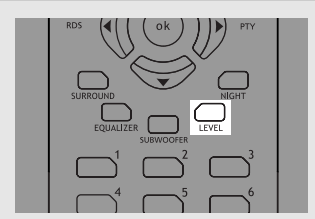

2. To adjust the volume level of the test tone, turn the **VOLUME** knob or press the \triangle + or - buttons on the remote control to adjust the master volume (if necessary).

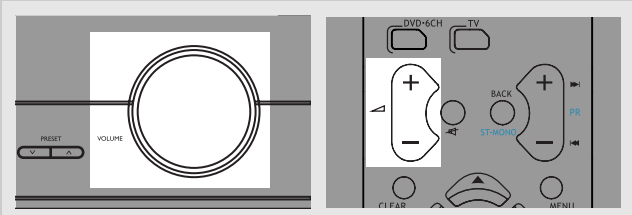

Press **LEVEL** again and press the Up or Down buttons to adjust the individual channel noise level.

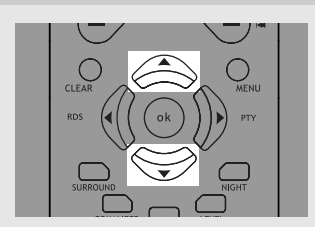

Adjust Individual Speaker Volume

1. To adjust individual speaker volume level, press the **LEVEL** key on the remote control.
2. Continue to press the **LEVEL** button on the remote control to select the channel to be adjusted, then press the Up or Down buttons to adjust the level.

You can adjust the master volume level by turning the **VOLUME** knob or press the \triangle + or - buttons on the remote control.

Advanced Setting

Factory defaulted Advance setting indication from VFD

The receiver has defaulted the following distances:

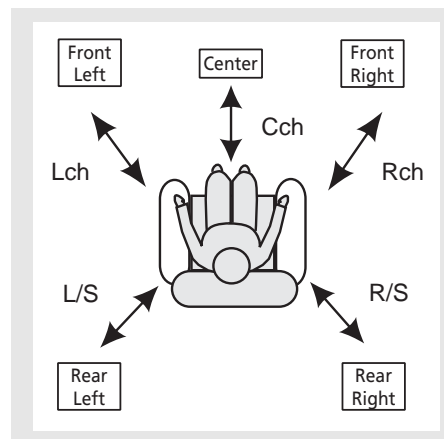

Front speakers (FRNT) 5m
Center speaker (CNTR) 5m
Rear speaker (SURR) 3m

Speaker Configurations

You can also change the setup of the speakers. Use a subwoofer to enjoy optimum sound.

- **Speaker distance:** For optimum surround experience measure the distance between the speaker and your favorite listening position.

1. Press the **SETUP** button to show setup options.

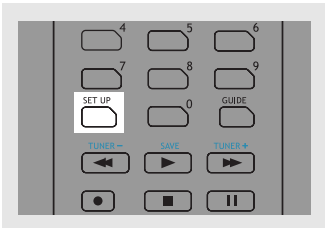

2. Press the Left or Right adjustment buttons until the speaker you want to change is displayed.

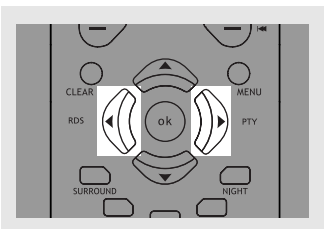

3. Press the Up or Down arrow buttons to change the speaker settings. Your selection will be stored automatically.

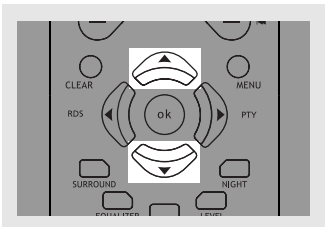

4. Repeat step 2 and 3 to set up the next speaker

Center Speaker selection (CTR)	YES / NO
Surround Speaker selection (SURR)	YES / NO
Front Speaker distance (FRNT)	1 -10 m
Centre Speaker distance (CNTR)	0 -10 m
Rear Speaker distance (SURR)	0 -10 m

5. When set up is done, wait for 5 seconds to automatically save your settings or press any key to save your selection and set up mode.

Advance Sound Control

NOTE

EN

By default, the Center and Surround Speakers are set to YES. If you decide not to use them, set the ones you do not intend to use to NO so the sound performance is not affected.

Displaying Program Formats

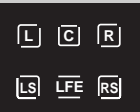

When a digital source starts playing, the receiver automatically switches to the proper surround mode and provides setting information via the speaker icons located on the right-hand side of the display.

It is important to note, however, that not all Dolby Digital sources are encoded with the full complement of five channels plus LFE*. Speaker icons show how many and which speaker you have enabled (See "Fine Setting of the Speakers") and the letters inside the speaker icons show which channel is present in the source information. For example, the diagram shown means you have all five speakers and subwoofer enabled and the digital sources you played have five channels plus LFE complemented.

* LFE stands for Low Frequency Effect. The indication "LFE" appears if the digital source contains LFE information. In this case, the bass signal will be delivered to the subwoofer, offering more dynamic deep bass sound effects. If the letter is flashing, the signal is either too weak or just gone.

Troubleshooting Tips

Troubleshooting Tips

Receiver/Tuner Operation

ST indicator is off.

- Adjust the antenna.
- Press **GO BACK/ST.MONO** button to insure you are not outputting in mono.

The signal is Mono. Severe hum or noise.

- The signal is too weak. Connect an external antenna.
- Adjust Antenna
- Reposition Antenna away from any electronics.

There is interference to FM reception.

- Turn off other electrical units (e.g. DVD, CD player) near the receiver.

Remote Control Operation

The remote control does not operate the unit.

- Another source mode is selected on the remote. Press the correct Source Button.
- No batteries installed. (included with your system) Install the batteries before attempting to operate the remote. Be sure to match the + and - ends of each battery to the symbols shown in the remote battery compartment.
- The batteries are weak. Replace all batteries.
- The remote is not pointed at the remote control sensor on the main unit or there is an obstacle between the remote and the main unit.
- The remote control is too far from the main unit, move closer.

Remote loses Programmed codes.

- Weak batteries, replace batteries.

Remote forgets what source was selected.

- Weak batteries, replace batteries.

General

No audio.

- Make sure the speakers are connected.
- Check the input connections.
- Check the power cord connections.
- Make sure the MUTE signal on the front panel is off.
- Make sure the digital setting (optical, coaxial or analog) is correct.
- Check that the headphone is not inserted.

No audio from one channel.

- Check the speaker level setting.
- Check the speaker wire or external source cable connections.

Noise occurs when the TV is turned on.

- The TV is too close to the audio system.

Specific instruments sound displaced.

- Check the connections between the receiver and the speakers if the sound does not match the video.
- Check if the video and audio cable are correctly inserted.

Cleaning the Exterior

Disconnect the system from AC power before cleaning the exterior of the system with a soft dust cloth, or with a slightly damp leather chamois. Never use strong solvents.

Disconnect the audio system from the power source before performing any maintenance.

Cleaning

Clean the exterior of the system using a soft dust cloth.

Important battery information

- Remove the batteries to avoid leakage if you do not use your remote control for more than one month.
- Discard leaky batteries immediately as leaking batteries may cause skin burns or other personal injuries.
- Dispose of batteries in the proper manner, according to provincial and local regulations.
- Any battery may leak electrolyte if mixed with a different battery type, if inserted incorrectly, if all batteries are not replaced at the same time, if disposed of in fire, or if an attempt is made to charge a battery not intended to be recharged.

Safety precautions

- Never open the cabinet under any circumstances. Any repairs or internal adjustments should be made only by a trained technician.
- Never operate this product with the cabinet removed.
- Do not touch the player with wet hands. If any liquid enters the player cabinet, take the player to a trained technician for inspection.
- The apparatus shall not be exposed to dripping and splashing.
- No object filled with liquids, such as vases, shall be placed on the apparatus.
- No naked flame sources such as lighted candles, shall be placed on the apparatus.

Headset safety

- Do not play your headset at a high volume. Hearing experts warn against extended high-volume play.
- If you experience a ringing in your ears, reduce volume or discontinue use.
- You should use extreme caution or temporarily discontinue use in potentially hazardous situations.
- Even if your headset is an open-air type designed to let you hear outside sounds, don't turn up the volume so high that you are unable to hear what is around you.

Don't infringe

This product should only be used for the purposes for which it is sold, that is, entertainment, violating no copyright law. Any attempts to use this product for which it is not intended is unlawful and therefore not condoned by Thomson.

Care and Maintenance

Equipment Specifications:

AMPLIFIER SECTION:

EN

RMS Output Power: Dolby Digital Mode with 10% Total Harmonic Distortion

Rear Channels: 55 Watts each Channel (1KHz, 6 Ohm)

Front and Center Channel: 98 Watts (1KHz, 3 Ohm)

Subwoofer Channel: 98 Watts (100Hz, 3 Ohm)

Total RMS Output Power, Dolby Digital mode : 500 W

DIN Output Power: Dolby Digital Mode with 10% Total Harmonic Distortion

Front Channels (L and R): 50 Watts per Channel (1KHz, 3 Ohm)

Rear Channels (L and R): 44 Watts per Channel (1KHz, 6 Ohm)

Center Channel: 90 Watts (1KHz, 3 Ohm)

Subwoofer Channel: 90 Watts (100Hz, 3 Ohm)

DIN Output Power: Dolby Digital Mode with 1% Total Harmonic Distortion

Front Channels (L and R): 34.1 Watts per Channel (1KHz, 6 Ohm)

Rear Channels (L and R): 34.1 Watts per Channel (1KHz, 6 Ohm)

Center Channel: 65 Watts (1KHz, 3 Ohm)

Subwoofer Channel: 65 Watts (100Hz, 3 Ohm)

Muting Attenuation: 65dB

Frequency Response: 20kHz +/-3dB, 1kHz ref.

Subwoofer Frequency Response: 10 Hz / -3db, 80Hz ref.

DIN 1kHz FL / FR STEREO mode : 45W x2 @ 6ohm <10% THD

Signal to Noise Ratio: 65dB (Dolby digital mode)

Video Signal to Noise Ratio from 40 dB to 60dB

AM TUNER SECTION:

Frequency Response: 2kHz +/-6dB, 1kHz ref.

Usable Sensitivity: 800uV/m @ S/N 20dB

Signal to Noise: 38dB

IF Rejection: 35dB

FM TUNER SECTION:

Frequency Response: 15kHz +/-3dB, 1kHz ref.

Quieting: 24dBu

Signal to Noise: 60dB(stereo) / 65dB(mono)

IF Rejection: 50dB

Dimensions (H x W x D mm) :

Unit - 95 x 430 x 355

Front and Surround Speakers - 156 x 80 x 90

Center Speaker - 68 x 248 x 85

Subwoofer - 316 x 160 x 355

Free Manuals Download Website

<http://myh66.com>

<http://usermanuals.us>

<http://www.somanuals.com>

<http://www.4manuals.cc>

<http://www.manual-lib.com>

<http://www.404manual.com>

<http://www.luxmanual.com>

<http://aubethermostatmanual.com>

Golf course search by state

<http://golfingnear.com>

Email search by domain

<http://emailbydomain.com>

Auto manuals search

<http://auto.somanuals.com>

TV manuals search

<http://tv.somanuals.com>