

Technics®

Compact Disc Changer SL-PD887/SL-PD687

Operating Instructions

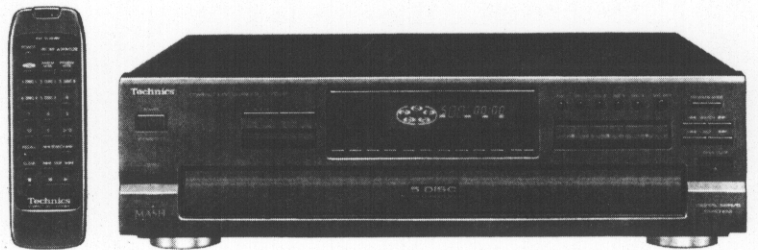

The photograph shows the SL-PD887 model.



Note:

The "EB" indication shown on the packing case indicates United Kingdom.

Before connecting, operating or adjusting this product, please read these instructions completely.

These operating instructions are applicable to the SL-PD887 and SL-PD687 models.

These operating instructions, however, fundamentally explain the operation of SL-PD887 model.

Dear Customer

Thank you for purchasing this Technics product. For optimum performance and safety, please read these instructions carefully.

Contents

Caution for AC mains lead (For United Kingdom).....	3
Suggestions for safety.....	4
Front panel controls.....	5
Connections.....	6
<hr/>	
Basic operations.....	7
Program play.....	9
Random play.....	10
Delete play.....	11
Spiral play.....	12
ID scan function SL-PD887 only	13
Search function.....	13
Skip function.....	14
Repeat function.....	15
Time mode selection.....	15
Edit guide function SL-PD887 only	16
<hr/>	
Concerning compact discs.....	17
Cautions concerning the moving of this unit.....	18
Technical specifications.....	18
Troubleshooting guide.....	19

(For areas except United Kingdom, Europe, Australia and N.Z.)

CAUTION:

The AC voltage is different according to the area.

Be sure to set the proper voltage in your area before use.

(For details, please refer to the page 6.)

CAUTION!

THIS PRODUCT UTILIZES A LASER. USE OF CONTROLS OR ADJUSTMENTS OR PERFORMANCE OF PROCEDURES OTHER THAN THOSE SPECIFIED HEREIN MAY RESULT IN HAZARDOUS RADIATION EXPOSURE. DO NOT OPEN COVERS AND DO NOT REPAIR YOURSELF. REFER SERVICING TO QUALIFIED PERSONNEL.

DANSK

BEMÆRK!

I DETTE APPARAT ANVENDES EN LASER. BRUG AF BETJENINGSKNAPPER ELLER REGULERINGER ELLER FREMGANGSMÅDER UDOVER DE I DENNE BETJENINGSVEJLEDNING ANGIVNE, KAN MEDFØRE FARE FOR BESTRÅLING. ÅBN IKKE KABINETTET OG FØRSØG IKKE AT UDFØRE REPARATIONER SELV. REPARATIONER MÅ KUN FORETAGES AF KVALIFICEREDE TEKNIKERE.

SUOMI

VAROITUS!

LAITTEEN KÄYTTÄMINEN MUULLA KUIN TÄSSÄ KÄYTTÖOHJEESSA MAINITULLA TAVALLA SAATTAA ALTISTAA KÄYTTÄJÄN TURVALLISUUSLUOKAN 1 YLITTÄVÄLLE NÄKYMÄTTÖMÄLLE LASERSÄTEILYLLE.

NORSK

ADVARSEL!

DETTE PRODUKTET ANVENDER EN LASER. BETJENING AV KONTROLLER, JUSTERINGER ELLER ANDRE INNGREP ENN DE SOM ER BESKREVENT I DENNE BRUKSANVISNING, KAN FØRE TIL FARLIG BESTRÅLING. DEKSLER MÅ IKKE ÅPNES, OG FØRSØK ALDRI Å REPARERE APPARATET PÅ EGENHÅND. ALT SERVICE OG REPARASJONSARBEID MÅ UTFØRES AV KVALIFISERT PERSONELL.

DANGER	INVISIBLE LASER RADIATION WHEN OPEN. AVOID DIRECT EXPOSURE TO BEAM.	(Inside of product)
ADVARSEL	USYNLIG LASERSTRÅLING VED ÅBNING. NÅR SIKKERHEDSÅFBRYDERE ER UDE AF FUNKTION. UNDGÅ UDSÆTTELSE FOR STRÅLING.	(Indersiden af apparatet)
VARO!	AVATTAESSA JA SUOJALUKUTUS OHITETTAESSA OLET ALTTIINA NÄKYMÄTÖNTÄ LASERSÄTEILYLLE. ÄLÄ KATSO SÄTEESEEN.	(Tuotteen sisällä)
VARNING	OSYNLIG LASERSTRÅLNING NÄR DENNA DEL ÄR ÖPPNAD OCH SPÄRREN ÄR URKOPPLAD. BETRÄKTA EJ STRÅLEN.	(Apparatens insida)
ADVARSEL	USYNLIG LASERSTRÅLING NÄR DEKSEL ÅPNES OG SIKKERHEDSÅS BRYTTS. UNDGÅ EKSPONERING FOR STRÅLEN.	(Produktets innside)
VORSICHT	UNSIICHTBARE LASERSTRÄHLUNG. WENN ABDECKUNG GEÖFFNET. NICHT DEM STRAHL AUSSETZEN.	(Im Inneren des Gerätes)



LUOKAN 1 LASERLAITE
KLASS 1 LASER APPARAT





(Back of product)
(Komponentens baksida)
(Produktets baksida)

Caution for AC mains lead

(For United Kingdom)

("EB" area code model only)

For your safety, please read the following text carefully.

This appliance is supplied with a moulded three pin mains plug for your safety and convenience. A 5-ampere fuse is fitted in this plug. Should the fuse need to be replaced please ensure that the replacement fuse has a rating of 5-ampere and that it is approved by ASTA or BSI to BS1362. Check for the ASTA mark  or the BSI mark  on the body of the fuse.

If the plug contains a removable fuse cover you must ensure that it is refitted when the fuse is replaced. If you lose the fuse cover the plug must not be used until a replacement cover is obtained. A replacement fuse cover can be purchased from your local dealer.

CAUTION!

IF THE FITTED MOULDED PLUG IS UNSUITABLE FOR THE SOCKET OUTLET IN YOUR HOME THEN THE FUSE SHOULD BE REMOVED AND THE PLUG CUT OFF AND DISPOSED OF SAFELY. THERE IS A DANGER OF SEVERE ELECTRICAL SHOCK IF THE CUT OFF PLUG IS INSERTED INTO ANY 13-AMPERE SOCKET.

If a new plug is to be fitted please observe the wiring code as shown below. If in any doubt please consult a qualified electrician.

IMPORTANT

The wires in this mains lead are coloured in accordance with the following code:

Blue: Neutral, Brown: Live.

As these colours may not correspond with the coloured markings identifying the terminals in your plug, proceed as follows:

The wire which is coloured Blue must be connected to the terminal which is marked with the letter N or coloured Black or Blue.

The wire which is coloured Brown must be connected to the terminal which is marked with the letter L or coloured Brown or Red.

WARNING: DO NOT CONNECT EITHER WIRE TO THE EARTH TERMINAL WHICH IS MARKED WITH THE LETTER E, BY THE EARTH SYMBOL \perp OR COLOURED GREEN OR GREEN/YELLOW.

THIS PLUG IS NOT WATERPROOF—KEEP DRY.

Before use

Remove the connector cover as follows.

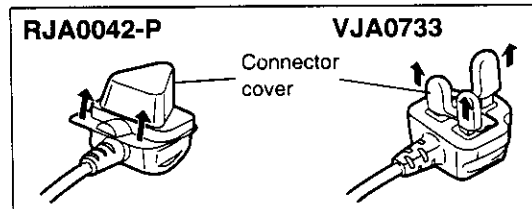

How to replace the fuse

1. Open the fuse cover with a screwdriver.

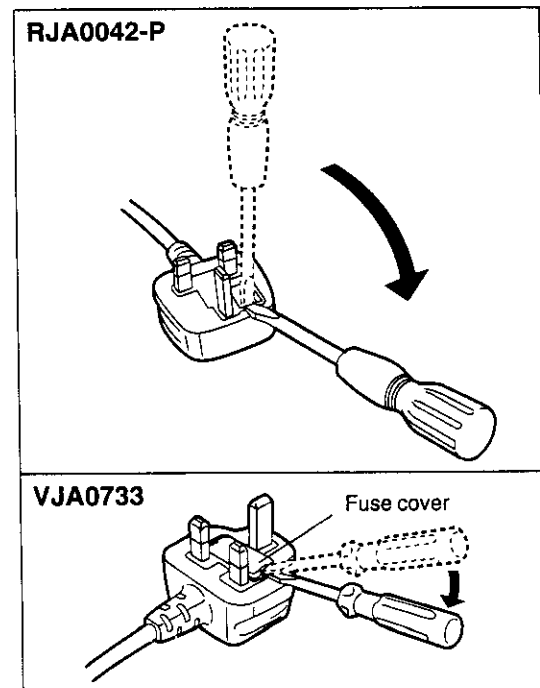

2. Replace the fuse and close or attach the fuse cover.

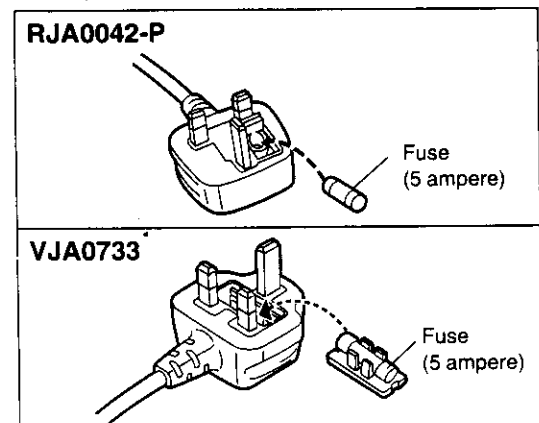

Suggestions for safety

Placement

Avoid placing the unit in areas of:

- direct sunlight
- high temperature
- high humidity
- excessive vibration
- uneven surfaces. (Place the unit on a flat level surface).

Such conditions might damage the cabinet and/or other component parts and thereby shorten the unit's service life.

Ventilation

Place the unit in a well ventilated position at least 10 cms away from wall surfaces etc.

Stacking

Never place heavy items on top of the unit or the power cord.

Voltage

- It is very dangerous to use an AC power source of high voltage such as for an air conditioner.
A fire might be caused by such a connection.
- A DC power source can not be used.
Be sure to check the power source carefully, especially on a ship or other place where DC is used.

Power cord protection

- Avoid cuts, scratches or poor connection of the AC mains cord, as this may result in fire or electric shock hazard.
Excessive bending, pulling or slicing of the cord should also be avoided.
- Do not pull on the cord when you are disconnecting the power, as this could cause an electric shock. Grasp the plug firmly when you disconnect the power supply.
- Never touch the plug with wet hands or a serious electric shock could result.

Foreign materials

- Ensure that no foreign objects, such as needles, coins, screwdrivers etc, accidentally fall into the unit or through the ventilation holes.
Otherwise, a serious electric shock or malfunction could occur.
- Be extremely careful about spilling water or liquid on/into the unit, as a fire or electric shock could occur.
(Disconnect the power plug and contact your dealer immediately if this occurs.)
- Avoid spraying insecticides onto the unit as they contain flammable gases which can be ignited.
- Insecticides, alcohol, paint thinner and similar chemicals should never be used to clean the unit as they can cause flaking or cloudiness to the cabinet finish.

Maintenance

Clean the cabinet, panel and controls with a soft cloth lightly moistened with mild detergent solution.

Do not use any type of abrasive pad, scouring powder or solvent such as alcohol or benzene.

Service

- Never attempt to repair, disassemble or reconstruct the unit if there seems to be a problem.
A serious electric shock could result if you ignore this precautionary measure.
- If a problem occurs during operation (the sound is interrupted, indicators fail to illuminate, smoke is detected, etc) contact your dealer or Authorised Service Center immediately.
- Disconnect the power supply if the unit will not be used for a long time. Otherwise the operation life could be shortened.

Other notes

Avoid places such as the following:

- Near any equipment or device that generates strong magnetism.
- On any heat-generating equipment or device, or in any place where the temperature is high (35° C or higher).
- Extremely cold place (5° C or below).
- Near a tuner or TV (It may cause noise in the broadcast, or disturbance of the TV picture.).

When carrying or storing the unit, handle it with care so it is not subjected to any strong bumps.

Always remove the discs before storing the unit for any period of time.

To avoid problems due to vibration.

- Do not place a book or similar object under this unit.
- Do not route the connection cables (of this or other units) across the operation panel, across the top, or under the unit.

Moisture may form on the lens in the following cases...

- Immediately after a heater has been turned on.
- In a steamy or very humid room.
- When the unit is suddenly moved from a cold environment to a warm one.

If moisture forms inside this unit, it may not work properly. In this case, turn on the power and wait about one hour for the moisture to evaporate.

Front panel controls

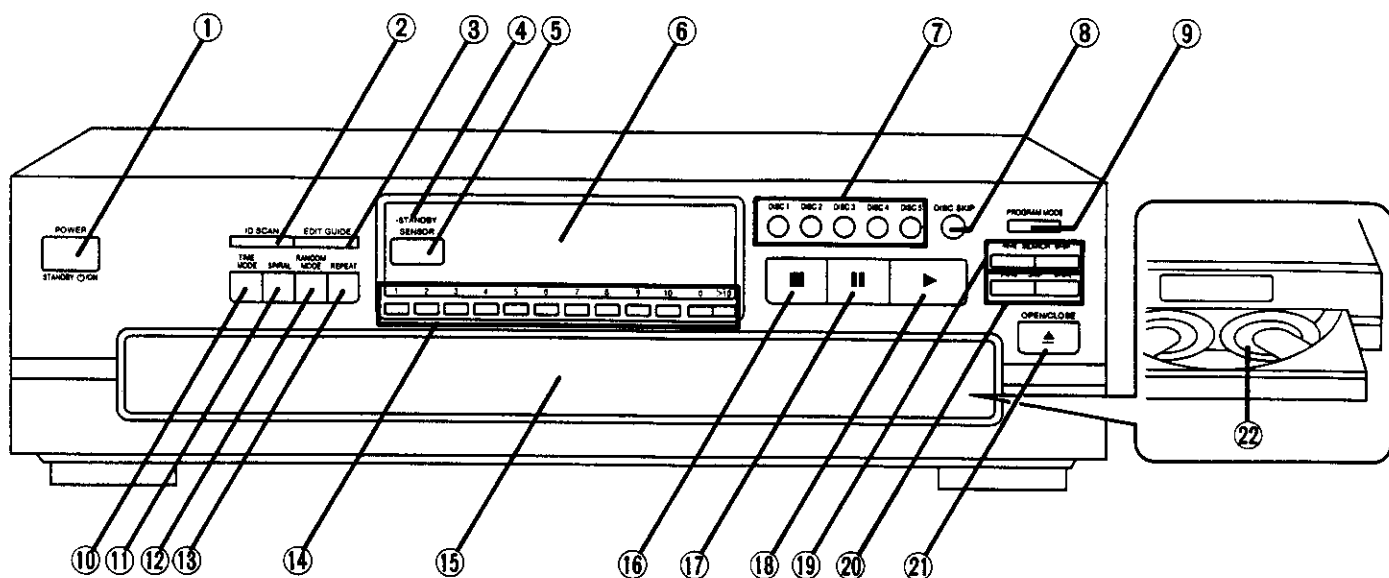

No.	Name	Ref. page
①	Power "STANDBY $\text{\textcircled{I}}$ /ON" switch (POWER, STANDBY $\text{\textcircled{I}}$ /ON)	7
Press to switch the unit from on to standby mode or vice versa. In standby mode, the unit is still consuming a small amount of power.		
②	ID scan button (ID SCAN) SL-PD887 only	13
③	Edit guide button (EDIT GUIDE) SL-PD887 only	16
④	"STANDBY" indicator (STANDBY)	—
When the unit is connected to the AC mains supply, this indicator lights up in standby mode and goes out when the unit is turned on.		
⑤	Remote control signal sensor (SENSOR) For SL-PD687	—
The word "SENSOR" does not appear on the panel, but if you have an amplifier (or receiver) with remote control transmitter which is manufactured by Technics, it is possible to operate the main unit using this remote control transmitter. (Some remote control transmitters cannot be used.)		
⑥	Display	—
⑦	Disc buttons (DISC 1–5)	7
⑧	Disc skip button (DISC SKIP)	7,14
⑨	Program mode button (PROGRAM MODE)	9,11

No.	Name	Ref. page
⑩	Time mode button (TIME MODE)	15
⑪	Spiral button (SPIRAL)	12
⑫	Random mode button (RANDOM MODE)	10
⑬	Repeat button (REPEAT)	15
⑭	Numeric buttons (1–10, 0, >10)	8
⑮	Loading drawer	7
⑯	Stop button (■)	8
⑰	Pause button (⏸)	8
⑱	Play button (▶)	8
⑲	Search buttons (◀◀ SEARCH ▶▶)	13
⑳	Skip buttons (◀◀ SKIP ▶▶)	14
㉑	Loading drawer open/close button (▲ OPEN/CLOSE)	7
㉒	Disc trays (1–5)	7

he supplied accessories

- ord..... 1 Stereo connection cable..... 1 Power plug adaptor..... 1
For Australia and N.Z.) (For others) **(Not supplied for United Kingdom, Europe, Australia and N.Z.)**

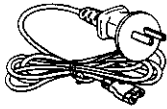

(RJA0036-K)

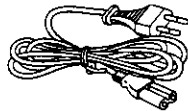

(RJA0019-2K)



(SJP2249-3)



(SJP5213-2)

nsmitter..... 1



(RAK-SL404WH)

Batteries..... 2
SL-PD887 only



(UM-4, "AAA", R03)

SL-PD887 only

For instructions on preparation and operation of the remote control transmitter, refer to the separate booklet titled "How to use the remote control transmitter".

hanger to your audio system, make sure
 anger and all other system components

elow shows the AC power supply cord
 household AC outlet, if the amplifier (or
 with an AC outlet, connect the cord to that

re AC outlet differs according to area.



(For United Kingdom only)
**BE SURE TO READ THE CAUTION FOR AC
 POWER SUPPLY CORD ON PAGE 3
 BEFORE THE FOLLOWING CONNEC-
 TIONS.**

**(For areas except United Kingdom, Europe, Australia
 and N.Z.)**

Set the voltage selector to the voltage setting for the area
 in which the unit will be used.

[Use a minus (-) screwdriver]

Note

If the power supply in your area is 117 V or 120 V, set to
 the "127 V" position.

Note that this unit will be seriously damaged if this setting
 is not made correctly.

If the power plug will not fit your socket,
 use the power plug adaptor (included).

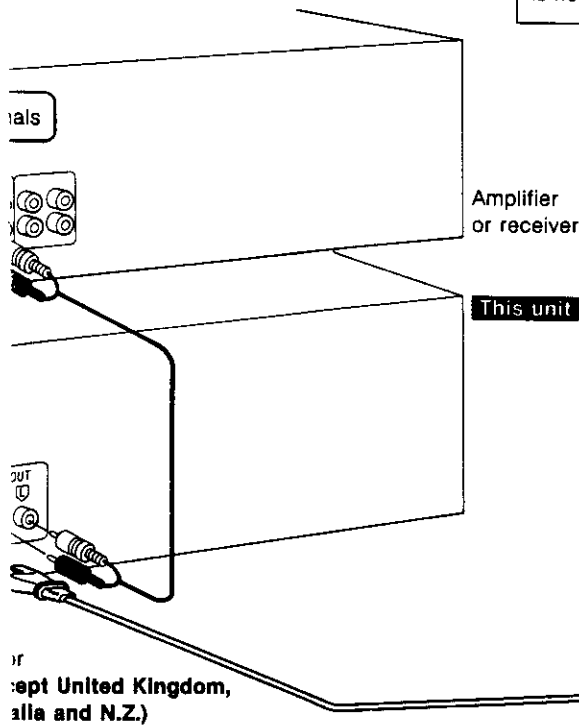
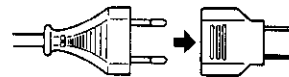

(For areas except Australia and N.Z.)
Insertion of Connector

Even when the connector is perfectly in-
 serted, depending on the type of inlet used,
 the front part of the connector may jut out
 as shown in the drawing.

However there is no problem using the unit.

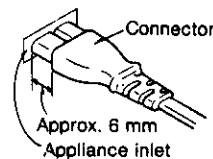

or
**(Not supplied for United Kingdom,
 Australia and N.Z.)**

Sequential play

All of the discs will be played, beginning from track 1 on the selected disc.

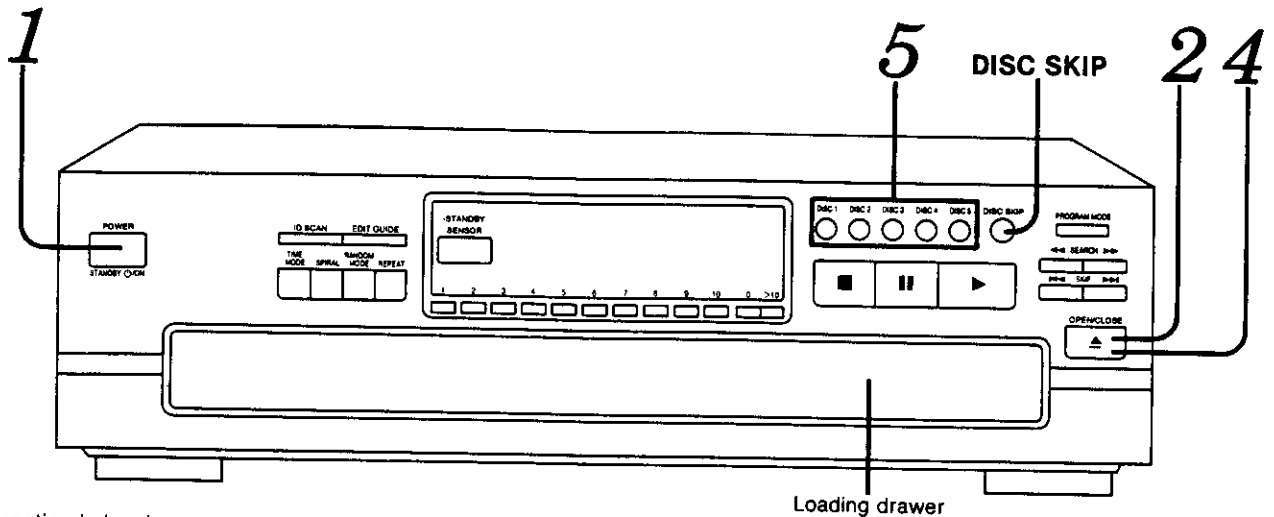

The explanation below is an example of operation in the case where all five disc trays in the changer are holding CDs.

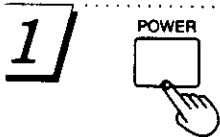

1 Press POWER.
The unit will switch on.

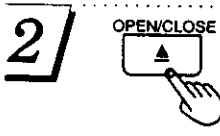

2 Press OPEN/CLOSE to open the loading drawer.
Indicates that the loading drawer is open.

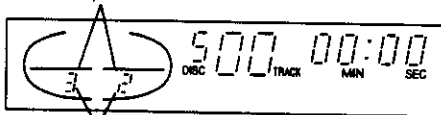

Numbers of the trays in which discs are loaded.

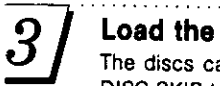

3 Load the disc(s) on the disc tray(s).
The discs can be loaded two at a time by pressing DISC SKIP to rotate the carousel.

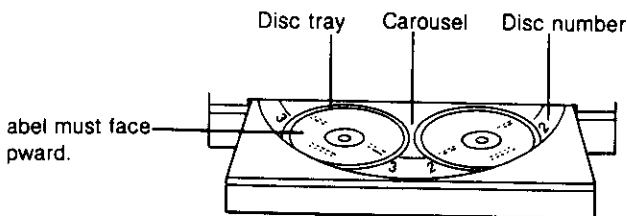

Note
Do not load 8 cm and 12 cm discs on the same disc tray.

CAUTION

Do not touch the loading drawer and carousel while they are in motion, and do not attempt to rotate the carousel by hand; doing so could result in incorrect operation of the unit and/or damage to the discs.

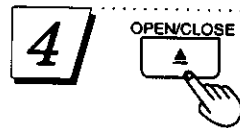

4 Press OPEN/CLOSE again to close the loading drawer.

Note
Do not attempt to close the drawer by hand.

Current play position (The numeral illuminates with a red color.)

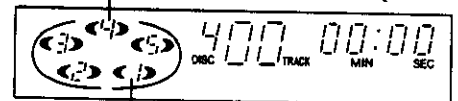

Illuminates when a disc is in the disc tray. If there is no disc in the disc tray, the indication disappears when the disc tray comes to the play position.



5 Press the desired disc button (1-5).

Play will begin from the selected disc. If a disc is not on the selected disc tray, the changer plays the disc at the next number.

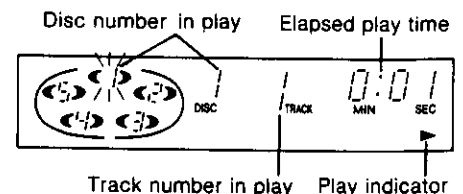
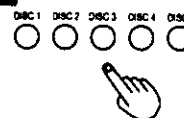

Track number in play Play indicator

The changer plays all the tracks on all the discs in order and stops automatically when the last track on the last disc finishes playing. The first disc will then be at the playing position.

Basic operations (continued)

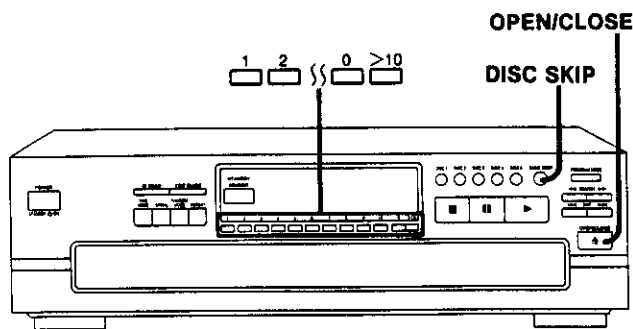

To directly access a desired track

Press the numeric button(s) to select the track.

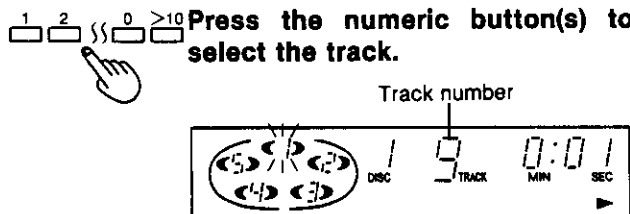

To select a track between 1 and 10:

Press the corresponding number on the numeric button.

To select a two-digit track number over 10:
First press >10, and then press the numbers for the two digits.

For example; number 20:

Press >10, then 2, and then 0.

To exchange discs during play

While playing a disc, it is possible to change the other discs without interrupting play.

① Press OPEN/CLOSE to open the loading drawer.

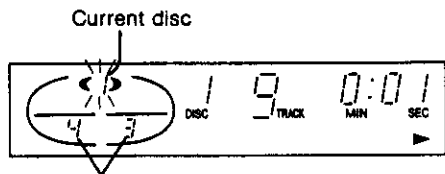

Discs which can be changed.

② Press DISC SKIP to rotate the disc trays and exchange the discs.

The carousel will move by one disc tray. Pressing again moves the carousel in the opposite direction by two disc trays.

③ Press OPEN/CLOSE to close the loading drawer.

Note

If you play a disc with the loading drawer open, discs other than the current disc cannot be played.

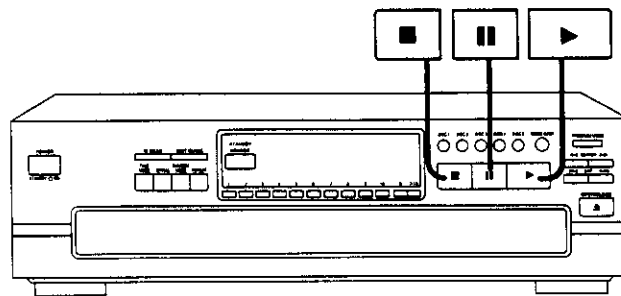

To temporarily stop play



Press **||**.

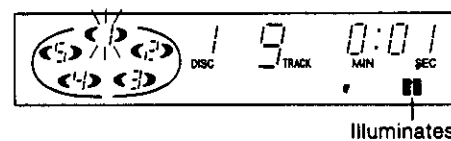

To resume play



Press **▶**.

To stop play



Press **■**.

The display will show the total number of tracks and the total playing time of the current disc.

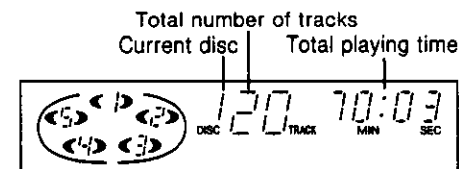

The total playing time displayed includes the silent sections between tracks. For this reason, it may be a few seconds longer than the playing time indicated on the disc.

To re-start play



Press **▶**.

CAUTION

Do not move this changer with a compact disc inside the unit. If a disc comes off the disc tray, it might be scratched or the changer might become incapable of playing. (Refer to "Cautions concerning the moving of this unit" on page 18.)

Program play

You can program up to 32 selections from the five discs in any order as you desire.

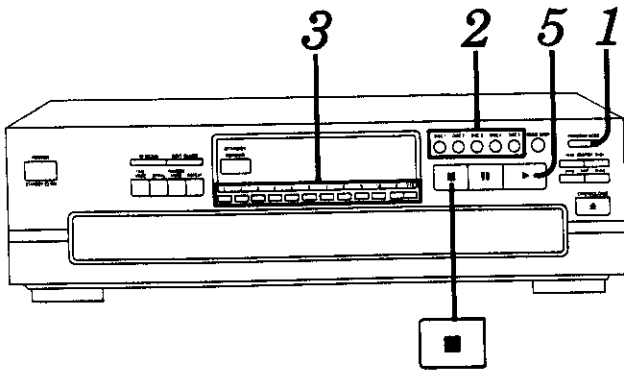

1 **PROGRAM MODE** [In the stop mode]
 Press **PROGRAM MODE** so that the "PGM" indicator illuminates.

Each time the button is pressed, the display will change in the following order:
 PGM → DEL → (off).

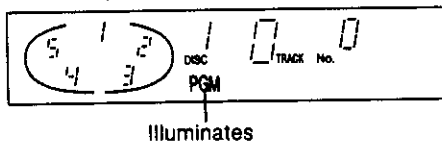

2 Press the desired disc button (1-5).

For example:
 To select disc 3, press DISC 3.

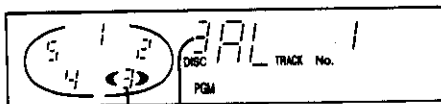
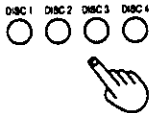

Specified disc number

The "AL" indication shows that all the tracks on the disc are selected.

To program by means of disc numbers only, repeat the above operation. (The count will increase by one for each operation.)

3 Press the numeric button(s) to specify the track number.

For example:
 To select track number 20, press >10, then 2, and then 0.

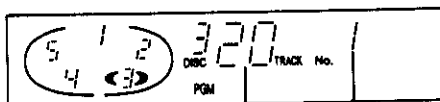
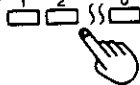

Specified track number Programmed order

4 Repeat steps 2 and 3 until you have completed the desired entry.

If you enter non-existing disc(s) or track(s) soon after the loading drawer is closed or when it is open, the corresponding indicator illuminates and the entry is included in the count. In the play mode, the changer will cancel the non-existing entry.

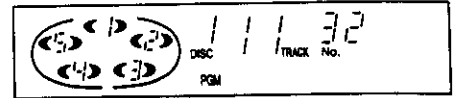

If you attempt a 33rd selection, the "F" (full) indication will be displayed.

5 Press ► to start play.



To enter additional selections during play, repeat steps 2 and 3.

To clear the entire programmed contents



[In the stop mode]
 Press ■.

To cancel program mode

PROGRAM MODE [In the stop mode]



Press **PROGRAM MODE** twice.

The changer will return to sequential play mode.

The programmed contents will remain stored in the memory until they are cleared, even after the program mode is canceled. Therefore, after using program play, it is possible to cancel the program mode and use another play mode (except delete play) and then still use the same program play again at a later time. In addition, if the disc is replaced with another one, program play will be carried out using the new disc. If non-existing entries occur at this time, they will be canceled.

For your reference:

The program mode and the programmed contents will remain stored in the memory even after the unit is switched off. However, if the power cord is unplugged or the power supply is otherwise interrupted for an extended length of time, the contents of the memory will be erased.

Program play (continued)

Using the remote control transmitter **SL-PD887 only**

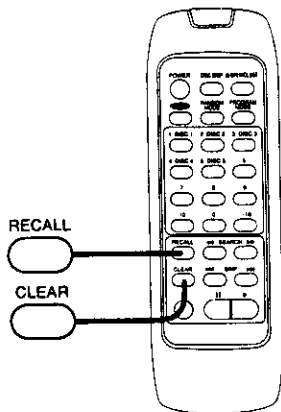

To confirm the programmed contents



Press **RECALL**.

Each time you press RECALL, the display shows the programmed disc and track number in the sequence you have entered.

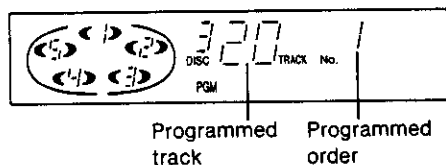

To clear a single item of the programmed contents



Press **CLEAR**.

Each time you press CLEAR, you will cancel last entry in the order you have entered.

To clear an entry in the middle of the program sequence, press RECALL repeatedly until the display shows the selection to be cleared, and then press CLEAR within three seconds after the last press.

Random play

All of the tracks will be played one time each in random order. There are two types of random play as described below.

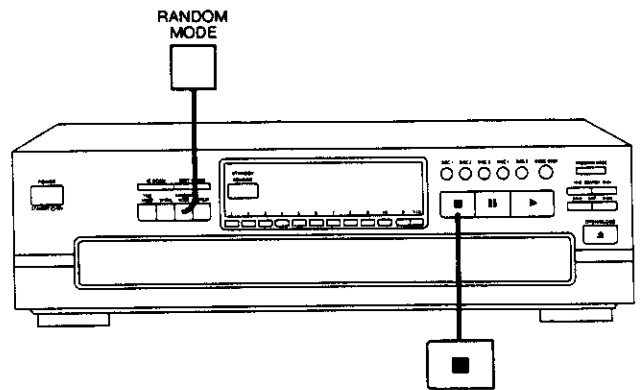

One disc random play

The changer will play all tracks on the current disc in a random order. Then it will choose a new disc randomly, excluding the discs already played, and play all tracks on that disc in a random order.

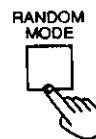

[In the stop or play mode]

Press **RANDOM MODE** so that the **"1 DISC RND"** indicator illuminates.

Each time the button is pressed, the display will change in the following order: 1 DISC RND → FULL RND → (off).

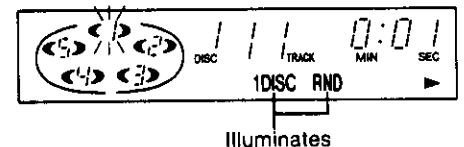

Full random play

Each track to be played back is selected randomly from all of the tracks on all of the discs, excluding the tracks that have already been played.

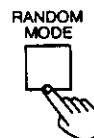

[In the stop or play mode]

Press **RANDOM MODE** so that the **"FULL RND"** indicator illuminates.

Each time the button is pressed, the display will change in the following order: 1 DISC RND → FULL RND → (off).

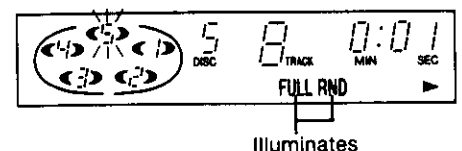

The changer will stop automatically when all the tracks on all discs have been played once.

To cancel random play mode



Press **■**.

The **"1 DISC (or FULL) RND"** indicator will go out.

Delete play

You can select up to 32 selections that you do not want to hear and put them in the changer's memory. Then you can enjoy sequential, one disc random, or full random play of only your favorite tracks.

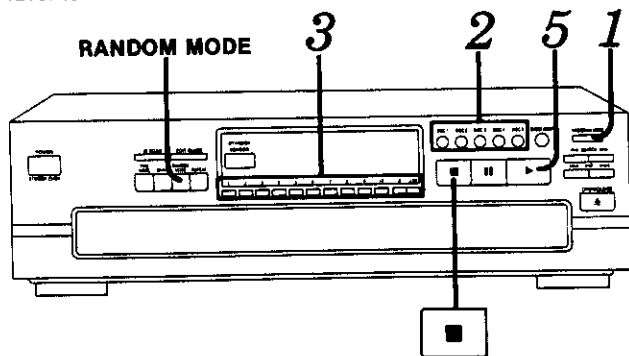

1 **PROGRAM MODE** [In the stop mode]
 Press **PROGRAM MODE** twice so that the "DEL" indicator illuminates.

Each time the button is pressed, the display will change in the following order:
 PGM → DEL → (off).

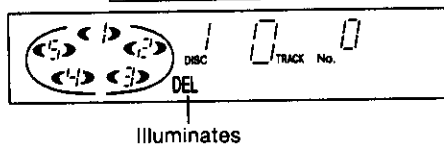

2 Press the disc button (1-5).
 For example:

To delete disc 3, press DISC 3.

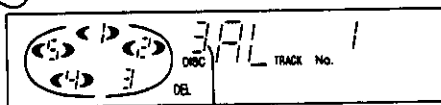
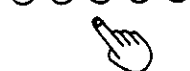

Specified disc number

The "AL" indication shows that all the tracks on the disc are selected.

To delete by means of disc numbers only, repeat the above operation. (The count will increase by one for each operation.)

3 Press the numeric button(s) to specify the track number.

For example:

To delete track number 20, press >10, then 2, and then 0.

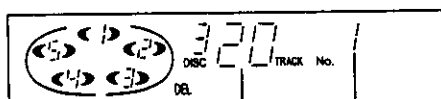

Specified track number Order you have entered

4 Repeat steps 2 and 3 until you have completed the desired entry.

If you enter non-existing disc(s) or track(s) soon after the loading drawer is closed or when it is open, the corresponding indicator illuminates and the entry is included in the count. In the play mode, the changer will cancel the non-existing entry.

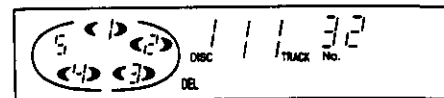

If you attempt a 33rd selection, the " - F " (full) indication will be displayed.

5 Press ► to start play.

To enter additional selections to be deleted during play, repeat steps 2 and 3.

For random play while deleting unwanted tracks

[Proceed through step 4 above, and then:]

To activate one disc random play, press RANDOM MODE.
 To activate full random play, press RANDOM MODE twice.

To clear the entire contents to be deleted



[In the stop mode]

Press ■.

To cancel delete mode

PROGRAM MODE [In the stop mode]



Press PROGRAM MODE.

The changer will return to sequential play mode.

The contents to be deleted will remain stored in the memory until they are cleared, even after the delete mode is canceled. Therefore, after using delete play, it is possible to cancel the delete mode and use another play mode (except program play) and then still use the same delete play again at a later time. In addition, if the disc is replaced with another one, delete play will be carried out using the new disc. If non-existing entries occur at this time, they will be canceled.

For your reference:

The delete mode and the contents to be deleted will remain stored in the memory even after the unit is switched off. However, if the power cord is unplugged or the power supply is otherwise interrupted for an extended length of time, the contents of the memory will be erased.

Delete play (continued)

Using the remote control transmitter **SL-PD887 only**

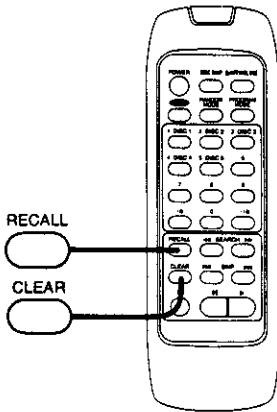

To confirm the selections to be deleted



Press **RECALL**.

Each time you press RECALL, the display shows the selected disc and track number in the sequence you have entered.

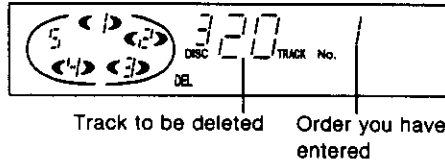

To clear a selection to be deleted



Press **CLEAR**.

Each time you press CLEAR, you will cancel last entry in the order you have entered.

To clear a selection in the middle of the sequence, press RECALL repeatedly until the display shows the selection to be cleared, and then press CLEAR within three seconds after the last press.

Spiral play

The changer plays the first tracks on all the loaded discs in sequence, followed by the second tracks on all the discs, and so on. (Refer to the illustration below.)

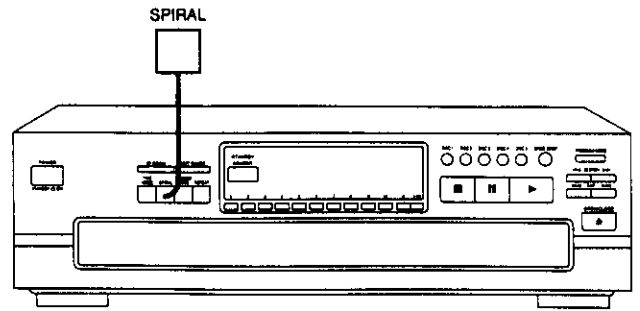

Example: When starting from disc 1

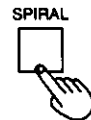
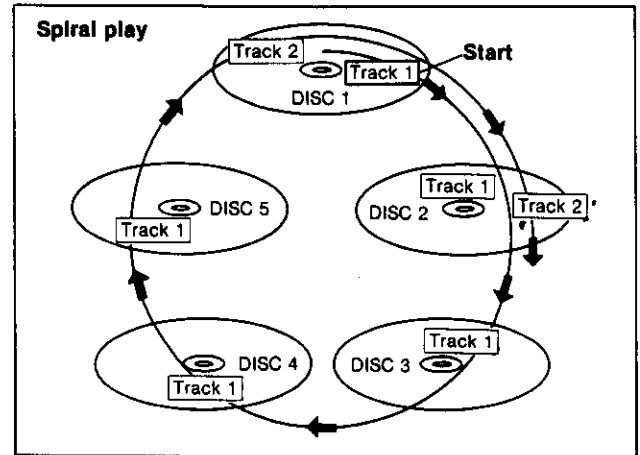

[In the stop or play mode]

Press **SPiRAL**.

Spiral play will begin with the first track on the disc situated at the playing position.

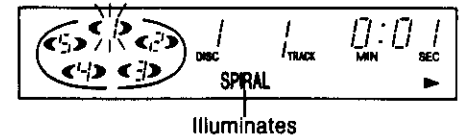

The changer will stop automatically when all the tracks on all discs have been played once.

For your reference:

When a disc with fewer tracks finishes playing, that disc will be skipped and the changer will continue playing the remaining track on the other discs in spiral sequence.

To cancel spiral play mode



Press **SPiRAL** again.

The "SPiRAL" indicator will go out.

The changer will return to sequential play mode from the current track on the current disc which is playing.

ID scan function

SL-PD887 only

This function is convenient to use when searching for a desired track.

The function will search from the beginning of the track for a loud section, and will play 10 seconds of the track centering around that point.

The order of scanning is the same as for play mode.

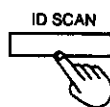
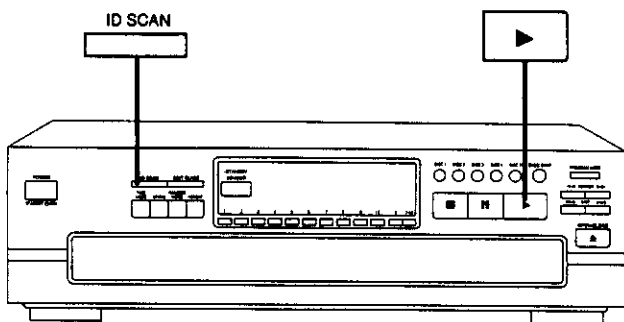

Press ID SCAN.

ID scan will start.

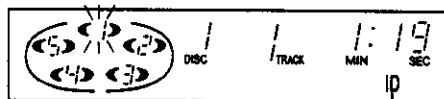

Illuminates

When the desired track has been found:



Press ►.

The changer will play the track from the beginning.

To cancel ID scan

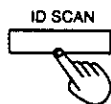

Press ID SCAN while this function is in operation.

The "ID" indicator will go out.

The changer will continue to play from the track being played.

Search function

You can search rapidly forward or backward on the disc for specific sections.

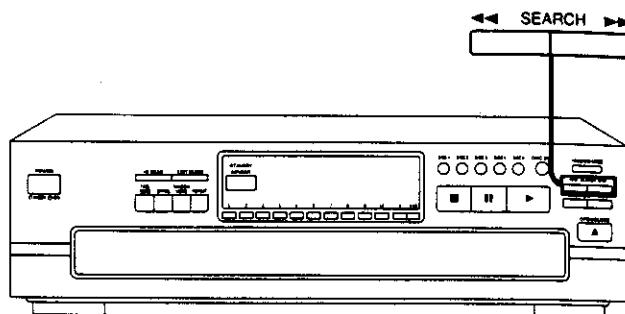

[In the play or pause mode]

Press and hold SEARCH (◀◀ or ▶▶).

◀◀: You can search backward.

▶▶: You can search forward.

Release the button when you reach the desired point.

The changer will return to the previous mode (play or pause).

In sequential play mode:

You can search forward over discs and backward within the current disc.

In other play modes:

You can search forward or backward only within the current track.

For your reference:

The search function will begin slowly, and then, if the button is held pressed for longer than 3 seconds, it will change to high-speed search.

In the play mode, the sound level decreases by 12 dB (1/4).

Skip function

To skip discs

Use this function to skip discs when selecting a disc to which you wish to listen, and when loading and unloading the discs.

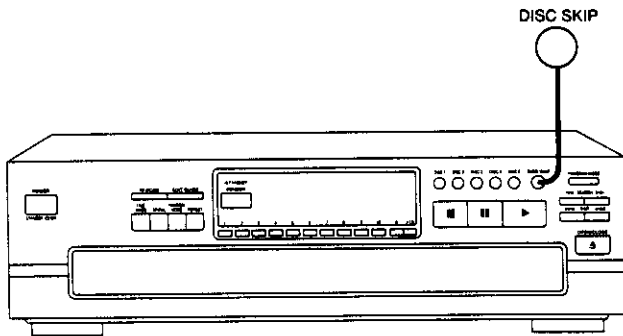

You can use this function in stop, sequential play, one disc random play and delete play modes.

DISC SKIP

Press DISC SKIP to rotate the disc tray.



Disc number at the playing position

In stop mode:

When the loading drawer is closed, pressing DISC SKIP changes the disc tray to the next one.

When the loading drawer is open, pressing DISC SKIP moves the carousel by two disc trays.

In play mode:

When the loading drawer is closed, pressing DISC SKIP changes the disc and the changer plays the tracks on the next disc.

If a disc is not on the selected disc tray, the changer plays the disc at the next number.

When the loading drawer is open, pressing DISC SKIP moves the carousel by one disc tray. Pressing again moves the carousel in the opposite direction so that you can change all discs except the one being played.

To skip tracks

Use this function to skip tracks when selecting a track to which you wish to listen.

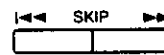
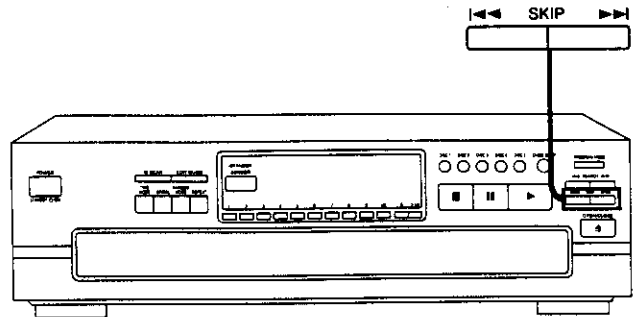

Press either SKIP (◀◀ or ▶▶) until you reach the desired track.

◀◀: You can skip backward.

▶▶: You can skip forward.

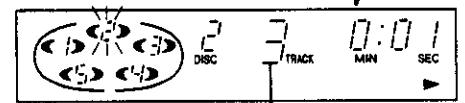

Track number at the playing position

In sequential/program/delete play mode:

In sequential play mode, you can skip only within the current disc. In program play mode, you can skip from one track to another in the programmed sequence.

In delete play mode, you can skip tracks only within the current disc excluding the tracks to be deleted.

◀◀: You can skip to the beginning of the track being played. If you press this button again quickly, you can skip to the beginning of the previous track.

Remember that in a backward skip, the current track is included in the count.

▶▶: You can skip as many tracks as the number of times you press the button.

In random play mode:

◀◀: You can skip to the beginning of the current track.

▶▶: You can skip to the beginning of a next track in random order.

In spiral play mode:

◀◀: You can skip to the beginning of the current track.

▶▶: You can skip to the beginning of the track on the next disc.

You can also skip tracks when the changer is in the stop mode or pause mode.

Repeat function

Play will continue endlessly in accordance with the specific play mode selected.

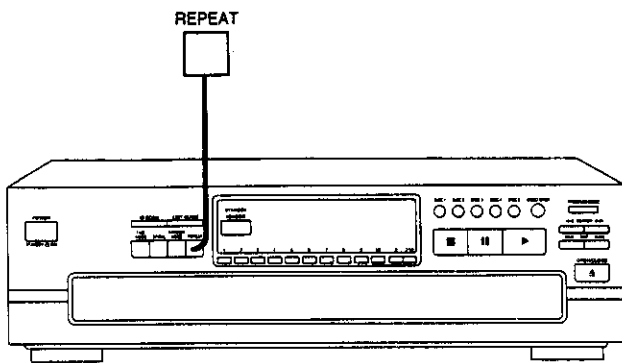

REPEAT



[Before or during play]

Press REPEAT.

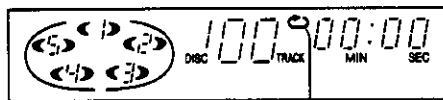

Illuminates

In sequential play mode:

All tracks of all discs will be played repeatedly.

In program play mode:

The changer plays only the programmed selections in the programmed sequence repeatedly.

In delete play mode:

The changer plays the discs and tracks excluding the selections to be deleted repeatedly.

In random play mode:

When the changer has played all the tracks on all the loaded discs, it will select a new random sequence and play continuously. The sequence differs each time.

In spiral play mode:

The changer plays all tracks of all discs repeatedly in the sequence of spiral play.

To cancel repeat mode

REPEAT



Press REPEAT again.

The " " indicator will go out.

Time mode selection

The various time information of the current disc can be displayed.

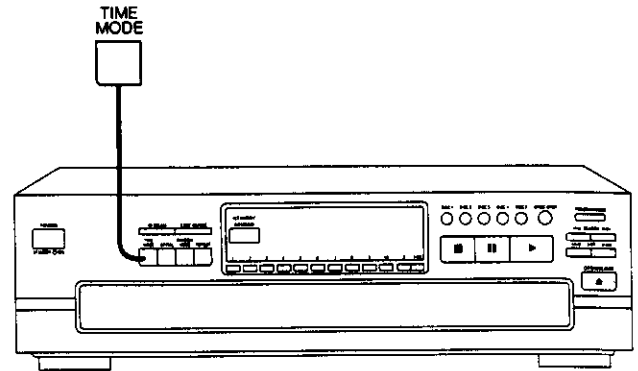

TIME MODE



[In the play or pause mode]

Press TIME MODE.

The information will change (as described below) each time you press the button.

① Track number and elapsed play time of the current track

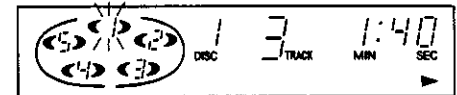

② Total remaining time on the disc

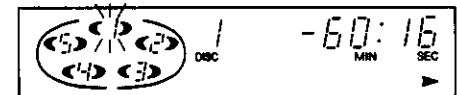

③ Track number and remaining time of the current track

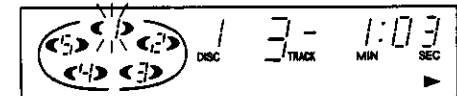

④ Total elapsed play time on the disc

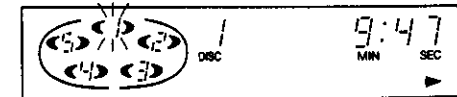

In all play modes:

When track number 21 or greater is playing, display ③ shows "----".

In program/delete/random/spiral mode:

The displayed information will alternate between displays ① and ③ each time the button is pressed.

SL-PD887 only

During operation of the edit guide function:

The remaining play time on side A or side B will be shown in display ②, and the elapsed play time for side A or side B will be shown in display ④.

When you stop playing and then start play again, the display will return to display ①.

Edit guide function **SL-PD887 only**

When recording, the changer will automatically program the tracks for tape sides A and B in accordance with the length of the tape so that none of the tracks will be interrupted before they are completed. In addition, the program will also include a silent interval of approximately 4 seconds between tracks.

Example: Recording from a disc containing seven tracks on to a 60-minute tape.

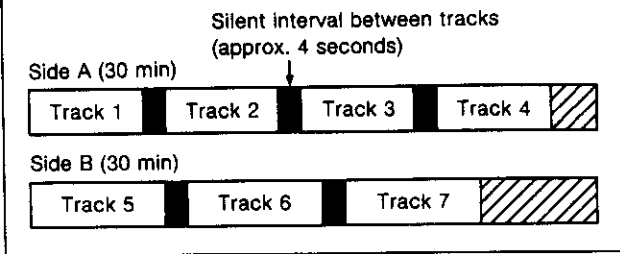

2 Prepare the tape deck for recording.

Set the Dolby NR, reverse mode, recording level, etc., as instructed in the Operating Instructions for the tape deck.

Note

Set so that recording is possible from the beginning of the tape.

3 EDIT GUIDE

Press EDIT GUIDE to select the tape length.

Each time you press the button, the display showing the tape length changes as follows. Choose the length of the tape you will use.

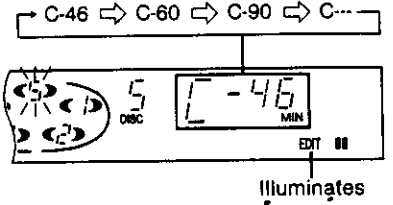

More precise time settings are also possible. (Refer to the instructions at right.)

The display shows the data of the tracks to be recorded as follows:

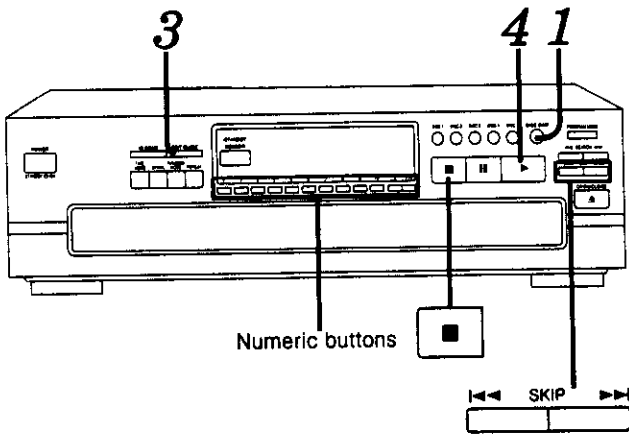

1 Press DISC SKIP to select the disc to be recorded.



Specified disc number

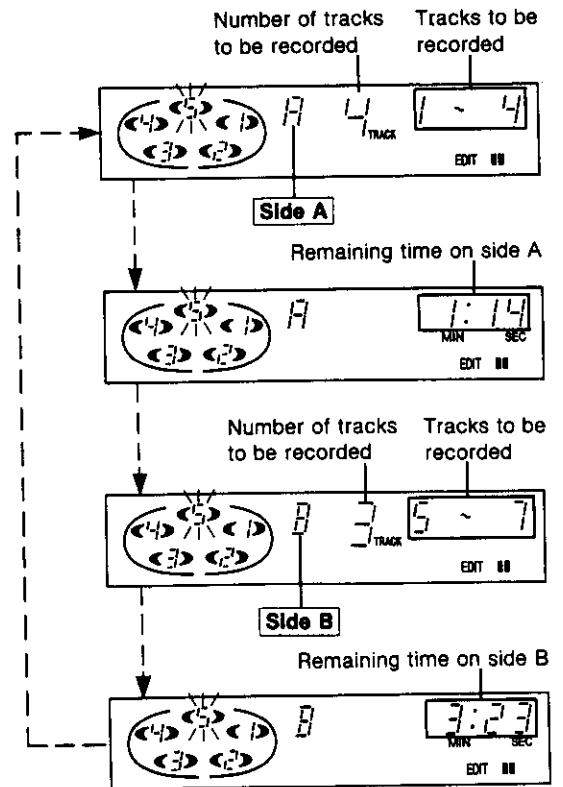

In this example, disc 5 can be recorded with tracks 1-4 on side A and tracks 5-7 on side B of the cassette tape.

4



[Start recording on the tape deck and then immediately:]

Press ►.

When the last track set for recording on side A is finished, the changer will enter the pause mode. Set the tape to the position from which recording will begin on side B, and then perform step 4 once again.

When all the programmed tracks on the specified disc finish playing, the changer will automatically stop. The edit guide mode will be canceled at the same time.

To enter a desired recording time other than 46, 60 or 90 minutes:

1. Select "C---" in step 3.
2. Enter the total recording time in minutes (1-99) using the numeric buttons.

For example:

To use 52-minute tape, press 5 then 2.

You can also specify the tape length pressing the SKIP button. Press either ◀◀ or ▶▶ from each step C-46, C-60, C-90 or C---

For example:

To use 52-minute tape, select C-46 and then press and hold ▶▶ until the display shows "52".

The maximum allowable playing time for editing is 99 minutes.

To stop recording



Press ■ and then press the stop button on the tape deck.

Note

Depending on the disc, a little of the beginning of the next track may be recorded onto the end of the track.

Concerning compact discs

With this changer, you can only play compact discs having this mark:



Handling precautions

To open the compact disc case, gently press the sides of the top and pull up.

To remove the disc from the case, press the center holder and lift the disc, holding by the edges.

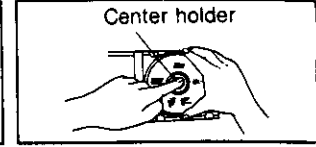
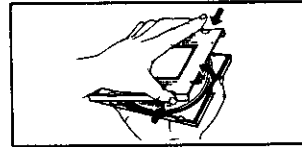

To return the disc to the case, insert the disc with the label facing up and press downward at the center.

Hold compact discs by the edges so as not to soil the surface with fingerprints. Fingerprints, dirt and scratches can cause skipping and distortion.

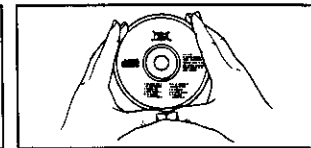
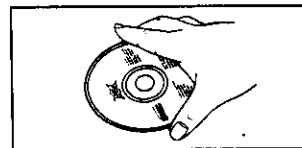

Do not use record cleaning sprays, benzene, thinner, static electricity prevention liquids or any other solvent on a disc.

If the surface is soiled, wipe gently with a soft, damp (water only) cloth.

Always move the cloth directly outward from the center of the disc, not in a circular motion as with standard phonograph records.

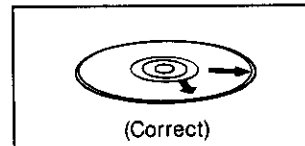

(Correct)

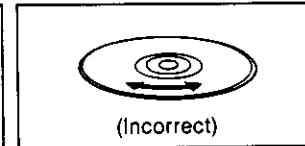

(Incorrect)

If you are taking the disc from a cold to a warm environment moisture may form on the disc. Wipe this off with a soft, dry, lint free cloth before using the disc.

Do not write on the label side with a ball-point pen or other writing instrument.

Storage precautions

Be sure to store discs in their cases to protect them from dust, scratches, and warping.

Do not place or store discs in the following places:

- 1) Locations exposed to direct sunlight
- 2) Humid or dusty locations
- 3) Locations directly exposed to a heat vent or heating appliance
- 4) In the glove compartment or on the rear deck of an automobile

Cautions concerning the moving of this unit

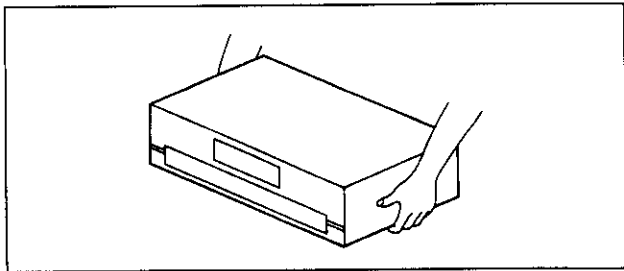

CAUTION

Before moving the changer to another location, be sure to carry out the "Preparations for moving the unit" described below.

Failure to do so will expose the compact discs and the changer to the risk of severe damage.

Preparations for moving the unit

All of the discs must be removed so that the trays are completely empty.

Use the following procedure.

- ① Press **POWER** to switch off the unit.
- ② Press **POWER** to switch on the unit.
(If there is a disc in the play section, it will be returned to the disc tray at this time.)
- ③ Press **OPEN/CLOSE** to open the loading drawer.
- ④ Press **DISC SKIP** to rotate the disc trays and remove the discs from all disc trays.
- ⑤ Press **OPEN/CLOSE** to close the loading drawer.
- ⑥ Press **POWER** to switch off the unit.

If you have pressed a wrong button by mistake, return to step ①.

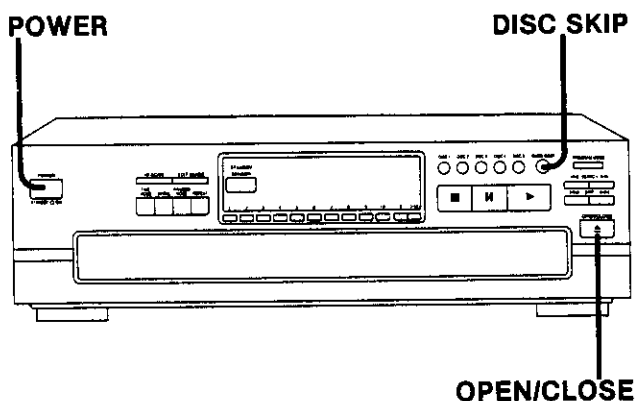

Technical specifications

AUDIO

No. of channels	2 (left and right, stereo)
Frequency response	2–20,000 Hz, ± 1 dB
Output voltage	2 V (at 0 dB)
Dynamic range	92 dB
S/N	100 dB
Total harmonic distortion	0.007% (1 kHz, 0 dB)
Wow and flutter	Below measurable limit
DA converter	MASH (1 bit)
Output impedance	Approx. 1 k Ω
Load impedance	More than 10 k Ω

PICKUP

Wavelength	780 nm
------------	--------

GENERAL

Power consumption	
For United Kingdom, Europe, Australia and N.Z.	12 W
For others	14 W
Power supply	
For United Kingdom, Europe, Australia and N.Z.	AC 50/60 Hz, 230–240 V
For others	AC 50/60 Hz, 110 V/127 V/220 V/230–240 V
Dimensions (W × H × D)	430 × 125 × 370 mm
Weight	4.6 kg

Note:

Specifications are subject to change without notice.
Weight and dimensions are approximate.

MASH is a trademark of NTT.

For United Kingdom

This apparatus was produced to BS 800.

Troubleshooting guide

Before requesting service for this unit, check the chart below for a possible cause of the problem you are experiencing. Some simple checks or a minor adjustment on your part may eliminate the problem and restore proper operation.

If you are in doubt about some of the check points, or if the remedies indicated in the chart do not solve the problem, refer to the directory of Authorized Service Centers (enclosed with this unit) to locate a convenient service center, or consult your Technics dealer for instructions.

Problem	Probable cause(s)	Suggested remedy
Changer will not play.	A disc(s) or other foreign object(s) has fallen inside the changer.	• Open the loading drawer, and then remove the object.
	Moisture has collected in the changer.	• Switch on and allow the changer to dry out for about one hour before using it.
The disc in the changer does not play.	The disc is upside down.	• Make sure the label is facing upward.
	The disc is dirty.	• Wipe the disc with a soft cloth.
	The disc is scratched.	• Replace the disc with a new one.
	The disc is warped.	
The disc is not within specified standards.		
Play stops before changing to the next disc.	The loading drawer is open.	• Press the OPEN/CLOSE button to close the loading drawer.
A certain music passage can't be played correctly.	The disc is dirty.	• Wipe the disc with a soft cloth.
	The disc is scratched.	• Replace the disc with a new one.
There is noise from the tuner or disturbance on the TV screen.	Caused by high-frequency signals from this changer.	• Use the changer further away from the tuner or TV. • If the tuner or TV's antenna is the indoor type, use an outdoor one.
When program play is started, an error message (-E) appears on the display.	Play was started without a track being programmed.	• Program a track.
An error message (-E) appears on the display, and the changer stops operating.	The mechanism of the changer has been improperly adjusted.	• Turn the unit off and then back on again. However, if the loading drawer is fully open, take out the compact disc(s) at the front position and then turn the unit off and then back on again.
The loading drawer stops in the middle of opening.		

Technics®

How to use the remote control transmitter RAK-SL404WH



Before use

Battery installation

Insert the batteries included with this unit as shown below.

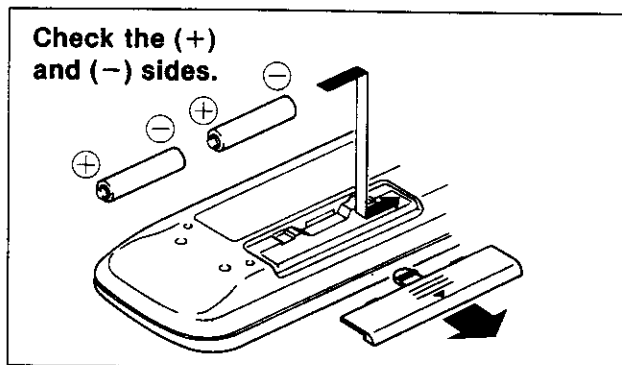

When you need to replace these batteries

Use two UM-4 "AAA", IEC R03 (1.5 V) or equivalent batteries.

Method for use

Use the remote control within 60 degrees and within 7 meters (23 ft.) facing directly toward the changer's remote control signal sensor.

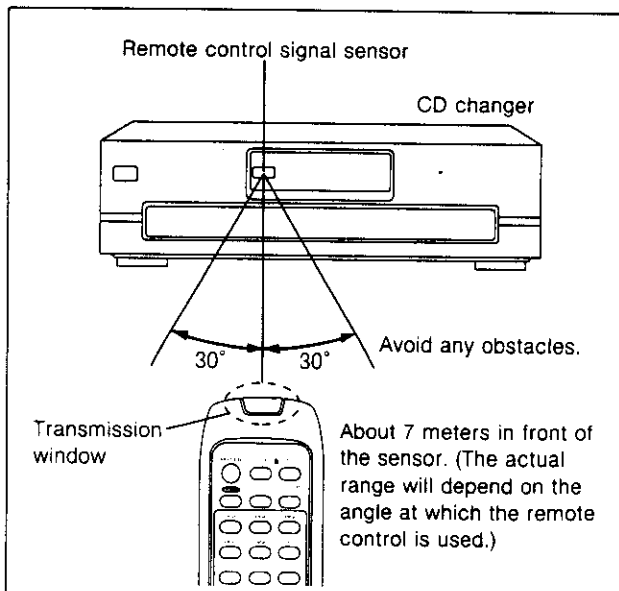

Note

Be sure the transmission window and the unit's sensor are free from dust. Excessive dust might affect performance.

The operation may not be correct if direct sunlight or another strong light source strikes the receiving sensor of this unit. If there is a problem, place the unit away from the light source.







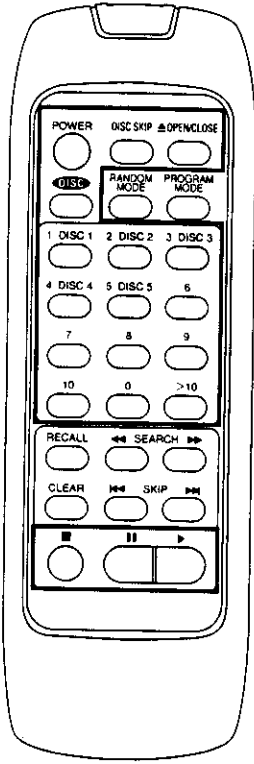

P PC E EB GC GN

RQT2788-P



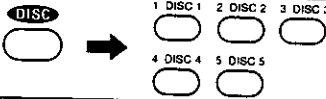
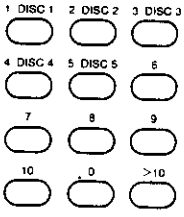

Quick reference table of remote control operation

For details about each function, refer to the operating instructions for the main unit.

Basic operation

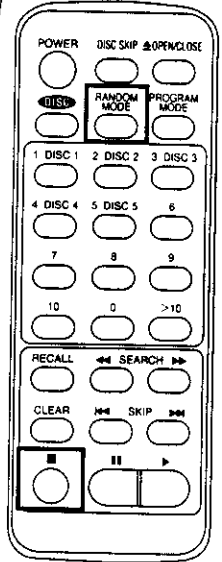
	To turn OFF/ON the main unit	POWER 
	To open/close the loading drawer	▲OPEN/CLOSE 
	To rotate the carousel	DISC SKIP 
	To select the desired disc number	DISC → 
	To select the desired track number	 <p> To select a track between 1 and 10: Press the corresponding number on the keypad. To select a two-digit track number over 10: First press >10, and then press the numbers for the two digits. </p>
	To start play	
	To stop play temporarily	 Press ► button to resume play.
To stop play		

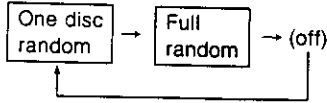
Random play





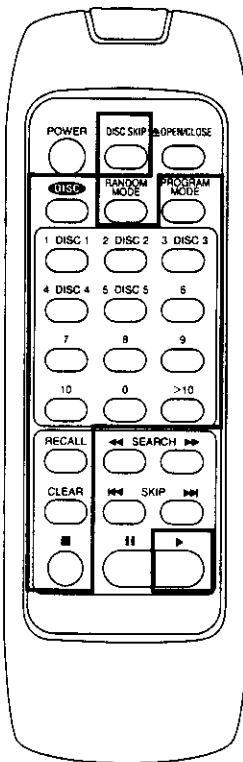

	To start one disc/full random play	RANDOM MODE  <p>Each time the button is pressed, the random mode will change in the following order:</p> 
	To stop random play	 <p>Random mode is also canceled at the same time.</p>













Program/delete play



To start program/delete play

① **PROGRAM MODE**
 Select program or delete mode. Each time the button is pressed, the program/delete mode will change in the following order:
Program → **Delete** → (off)

② **DISC**
 →    Select the disc number.
 

③   
  
  
  
 Select the track number.
 Repeat steps ② and ③ until you have completed the desired entry.

④  Start play.

To check the entered contents

RECALL
 The selections entered are displayed one by one each time this button is pressed.

To clear a single item of the entered contents

CLEAR
 Only the selection which is currently displayed is cleared.

To clear all entered contents

(In the stop mode)

To cancel program/delete mode

(In the stop mode)
PROGRAM MODE
 Press twice in program mode. Press once in delete mode.

Other functions

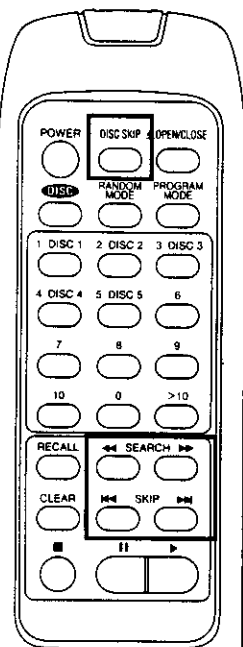



To skip discs

DISC SKIP

To skip tracks

 **SKIP** 

To search for a desired place

(In the play or pause mode)
 **SEARCH** 

Battery notes

Do not mix old and new batteries, or batteries of different types (carbon and alkaline, etc.).

Always remove old, weak or worn-out batteries promptly and dispose of them properly.

The average battery life is about one year.

Although the battery life varies depending on how often the device is used, you should generally replace the batteries about once a year.

The batteries should be replaced if commands from the remote control transmitter do not operate the unit even when the transmitter is held close to the front panel.

Never subject batteries to excessive heat or flame; do not attempt to disassemble them; and be sure they are not short-circuited.

If you will not use the remote control for a long period of time, remove the batteries and store them in a cool, dark place.

If a battery leaks, remove all batteries and dispose of them properly. Thoroughly clean the battery compartment before inserting new batteries.

If the leaking electrolyte comes into contact with skin or clothes, flush with water immediately.

Keep batteries out of reach of children.

Do not use rechargeable (nickel-cadmium) type batteries.

Do not attempt to recharge alkaline or carbon batteries.

Do not dispose of used batteries in household rubbish.

Troubleshooting guide

Problem	Probable cause(s)	Suggested remedy
Remote control does not operate correctly.	The batteries have run out.	• Replace batteries with new ones.
	There is an obstruction between the remote control and the changer.	• Remove the obstruction.
	The batteries are inserted incorrectly. [The (+) and (-) polarities are reversed.]	• Reinsert batteries so that the polarities are correct.

Free Manuals Download Website

<http://myh66.com>

<http://usermanuals.us>

<http://www.somanuals.com>

<http://www.4manuals.cc>

<http://www.manual-lib.com>

<http://www.404manual.com>

<http://www.luxmanual.com>

<http://aubethermostatmanual.com>

Golf course search by state

<http://golfingnear.com>

Email search by domain

<http://emailbydomain.com>

Auto manuals search

<http://auto.somanuals.com>

TV manuals search

<http://tv.somanuals.com>