

Stereo Cassette Deck

RS-TR575M2

Operating Instructions

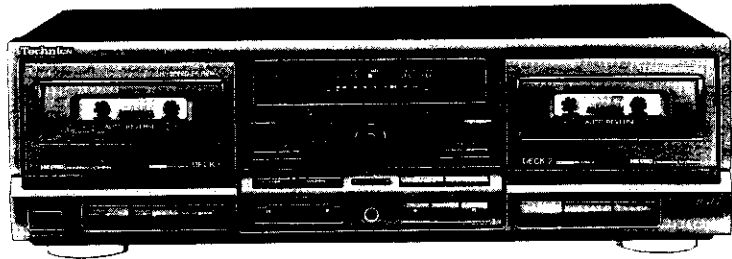

Technics®

Note:

The "EB" indication shown on the packing case indicates United Kingdom.

Before connecting, operating or adjusting this product, please read these instructions completely. Please save this manual.

RQT4645-B

EB GC GN

Suggestions for safety

Dear Customer

Thank you for purchasing this product. For optimum performance and safety, please read these instructions carefully.

(For areas except United Kingdom, Australia and N.Z.)

CAUTION:

The AC voltage is different according to the area.

Be sure to set the proper voltage in your area before use.

(For details, please refer to the page 5.)

Table of contents

Suggestions for safety	2
Caution for AC mains lead	3
Front panel controls	4
Connections	5
Playback	6
Dolby noise-reduction	7
Dolby HX-Pro headroom extension	7
Reverse function	8
To fast-forward or rewind the tape	8
To find the beginning of a program (TPS) ..	9
Linear counter	10
To listen through headphones	10
About the remote control function	10
Recording	11
ATC	14
Selecting the Dolby NR type	14
Recording level adjustment	14
Tape-to-tape recording	15
To make a silent interval	17
Concerning cassette tapes	18
Maintenance	18
Troubleshooting guide	19
Technical specifications	Back cover

Placement

Avoid placing the unit in areas of:

- direct sunlight
- high temperature
- high humidity
- excessive vibration
- uneven surfaces (Place the unit on a flat level surface.)

Such conditions might damage the cabinet and/or other component parts and thereby shorten the unit's service life.

Stacking

Never place heavy items on top of the unit or the AC power cord.

Voltage

- It is very dangerous to use an AC power source of high voltage such as for an air conditioner. A fire might be caused by such a connection.
- A DC power source can not be used. Be sure to check the power source carefully, especially if on a ship or other place where DC is used.

Power cord protection

- Avoid cuts, scratches or poor connection of the AC power cord, as this may result in fire or electric shock. Excessive bending, pulling or slicing of the cord should also be avoided.
- Do not pull on the cord when you are disconnecting the power, as this could cause an electric shock. Grasp the plug firmly when you disconnect the power supply.
- Never touch the plug with wet hands or a serious electric shock could result.

Foreign materials

- Ensure that no foreign objects, such as needles, coins, screwdrivers etc., accidentally fall into the unit. Otherwise, a serious electric shock or malfunction could occur.
- Be extremely careful about spilling water or liquid on/into the unit, as a fire or electric shock could occur. (Disconnect the power plug and contact your dealer immediately if this occurs.)
- Avoid spraying insecticides onto the unit as they contain flammable gases which can be ignited.
- Insecticides, alcohol, paint thinner and similar chemicals should never be used to clean the unit as they can cause flaking or cloudiness to the cabinet finish.

Service

- Never attempt to repair, disassemble or reconstruct the unit if there seems to be a problem. A serious electric shock could result if you ignore this precautionary measure.
- If a problem occurs during operation (the sound is interrupted, indicators fail to light up, smoke is detected, etc.) contact your dealer or Authorized Service Center immediately.
- Disconnect the power supply if the unit will not be used for a long time. Otherwise the operation life could be shortened.

CAUTION!

DO NOT INSTALL OR PLACE THIS UNIT IN A BOOKCASE, BUILT IN CABINET OR IN ANOTHER CONFINED SPACE IN ORDER TO KEEP WELL VENTILATED CONDITION. ENSURE THAT CURTAINS AND ANY OTHER MATERIALS DO NOT OBSTRUCT THE VENTILATION CONDITION TO PREVENT RISK OF ELECTRIC SHOCK OR FIRE HAZARD DUE TO OVERHEATING.

Supplied accessories

Please check and identify the supplied accessories.

Use numbers indicated in parentheses when asking for replacement parts.

AC power supply cord (1)

Stereo connection cables (2)

Power plug adaptor (1)
(For areas except United Kingdom, Australia and N.Z.)

(For United Kingdom)

(For Australia and N.Z.)

(For others)

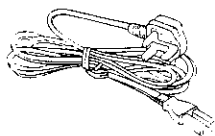

(RJA0053-2X)

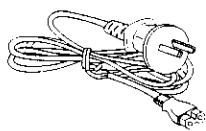

(RJA0035-K)

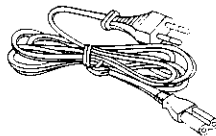

(RJA0019-X)

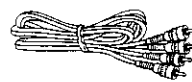

(SJP2249-3)



(SJP5213-2)

Caution for AC mains lead



(For United Kingdom)
("EB" area code model only)

For your safety, please read the following text carefully.

This appliance is supplied with a moulded three pin mains plug for your safety and convenience.

A 5-ampere fuse is fitted in this plug.

Should the fuse need to be replaced please ensure that the replacement fuse has a rating of 5-ampere and that it is approved by ASTA or BSI to BS 1362.

Check for the ASTA mark  or the BSI mark  on the body of the fuse.

If the plug contains a removable fuse cover you must ensure that it is refitted when the fuse is replaced.

If you lose the fuse cover the plug must not be used until a replacement cover is obtained.

A replacement fuse cover can be purchased from your local dealer.

CAUTION!

IF THE FITTED MOULDED PLUG IS UNSUITABLE FOR THE SOCKET OUTLET IN YOUR HOME THEN THE FUSE SHOULD BE REMOVED AND THE PLUG CUT OFF AND DISPOSED OF SAFELY.

THERE IS A DANGER OF SEVERE ELECTRICAL SHOCK IF THE CUT OFF PLUG IS INSERTED INTO ANY 13-AMPERE SOCKET.

If a new plug is to be fitted please observe the wiring code as shown below.

If in any doubt please consult a qualified electrician.

IMPORTANT

The wires in this mains lead are coloured in accordance with the following code:

Blue: Neutral, Brown: Live.

As these colours may not correspond with the coloured markings identifying the terminals in your plug, proceed as follows:

The wire which is coloured Blue must be connected to the terminal which is marked with the letter N or coloured Black or Blue.

The wire which is coloured Brown must be connected to the terminal which is marked with the letter L or coloured Brown or Red.

WARNING: DO NOT CONNECT EITHER WIRE TO THE EARTH TERMINAL WHICH IS MARKED WITH THE LETTER E, BY THE EARTH SYMBOL \perp OR COLOURED GREEN OR GREEN/YELLOW.

THIS PLUG IS NOT WATERPROOF-KEEP DRY.

Before use

Remove the connector cover.

How to replace the fuse

The location of the fuse differ according to the type of AC mains plug (figures A and B). Confirm the AC mains plug fitted and follow the instructions below.

Illustrations may differ from actual AC mains plug.

1. Open the fuse cover with a screwdriver.

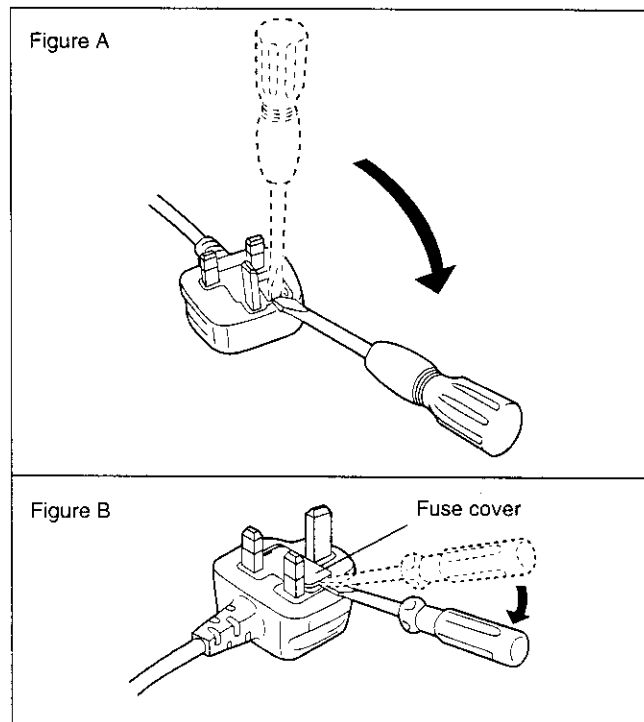

2. Replace the fuse and close or attach the fuse cover.

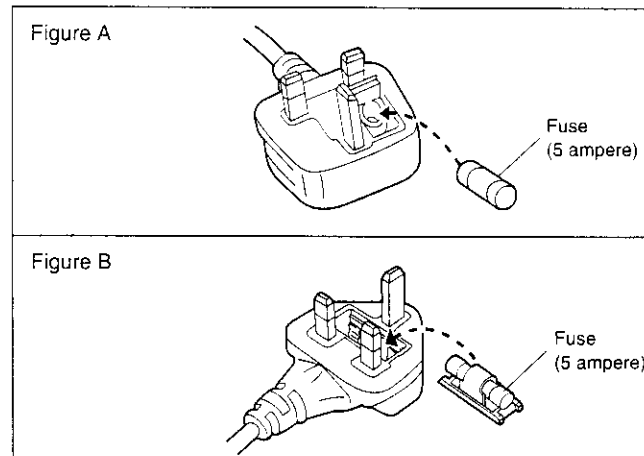

Front panel controls

Before use

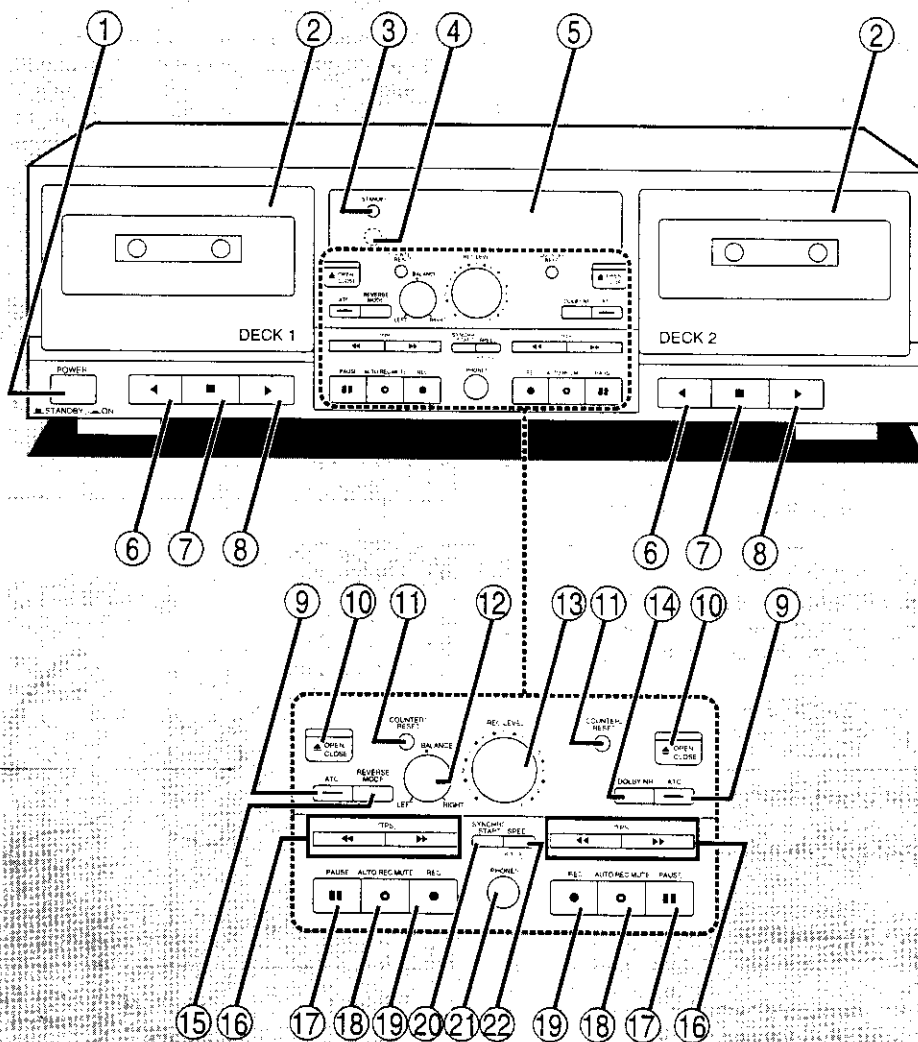

Some numbers (e.g. 2) appear twice in the illustration. The numbers on the left refer to the functions for DECK 1, and the numbers on the right to DECK 2.

No.	Name	Ref. page
①	Power " ■ STANDBY ⏻ ■ ON" switch (POWER, ■ STANDBY ⏻ ■ ON).....	6
	Press to switch the unit from on to standby mode or vice versa. In standby mode, the unit is still consuming a small amount of power.	
②	Cassette holder	
③	"STANDBY" indicator (STANDBY)	
	With the POWER button in the ON position (■) the unit can be switched between the STANDBY and ON condition using a remote control. In the STANDBY condition the indicator will light.	
④	Remote control signal sensor	
	This cassette deck can be operated by using the remote control provided with a Technics amplifier or receiver. (For detailed information, refer to the operating instructions of the amplifier or receiver.)	
⑤	Display	
⑥	Reverse-side playback button (◀)	6
⑦	Stop button (■)	6
⑧	Forward-side playback button (▶)	6
⑨	Auto tape calibration button (ATC).....	11

No.	Name	Ref. page
⑩	Open/close button (▲ OPEN/CLOSE).....	6
⑪	Counter reset button (COUNTER 1 (2) RESET).....	10
⑫	Recording-balance control (BALANCE).....	12
⑬	Recording-level control (REC LEVEL).....	12
⑭	Dolby noise-reduction button (DOLBY NR).....	6
⑮	Reverse-mode select button (REVERSE MODE).....	6
⑯	Rewind/fast-forward search buttons (◀◀ / ▶▶ [TPS]).....	8, 9
⑰	Pause button (⏸ PAUSE).....	6
⑱	Automatic-record-muting button (● AUTO REC MUTE)	17
⑲	Record button (● REC).....	11
⑳	Synchro-start button (SYNCHRO START)	15
㉑	Headphone jack (PHONES)	10
㉒	Tape-to-tape recording-speed button (SPEED $\times 1/$ ⓧ 2).....	15

Connections

Before making connections, make sure that the power to this unit and all other components is turned off.

FOR UNITED KINGDOM ONLY

BE SURE TO READ THE CAUTION FOR THE AC MAINS LEAD ON PAGE 3 BEFORE CONNECTION.

Note

- Separate the cables to avoid noise.
- Do not place this unit on top of an amplifier or receiver. Heat radiated from the top of the amplifier or receiver may cause damage to the tape.

Set the voltage

For models with a voltage selector (See illustration below) **Not applicable to United Kingdom, Australia and N.Z.**

Use a flat-head screwdriver to turn the voltage selector on the rear panel to the appropriate position for the area in which this unit is used.

If the power supply in your area is 115 V or 120 V, please set the voltage selector as follows:

For 115 V: Set to 110 V

For 120 V: Set to 127 V

Before use

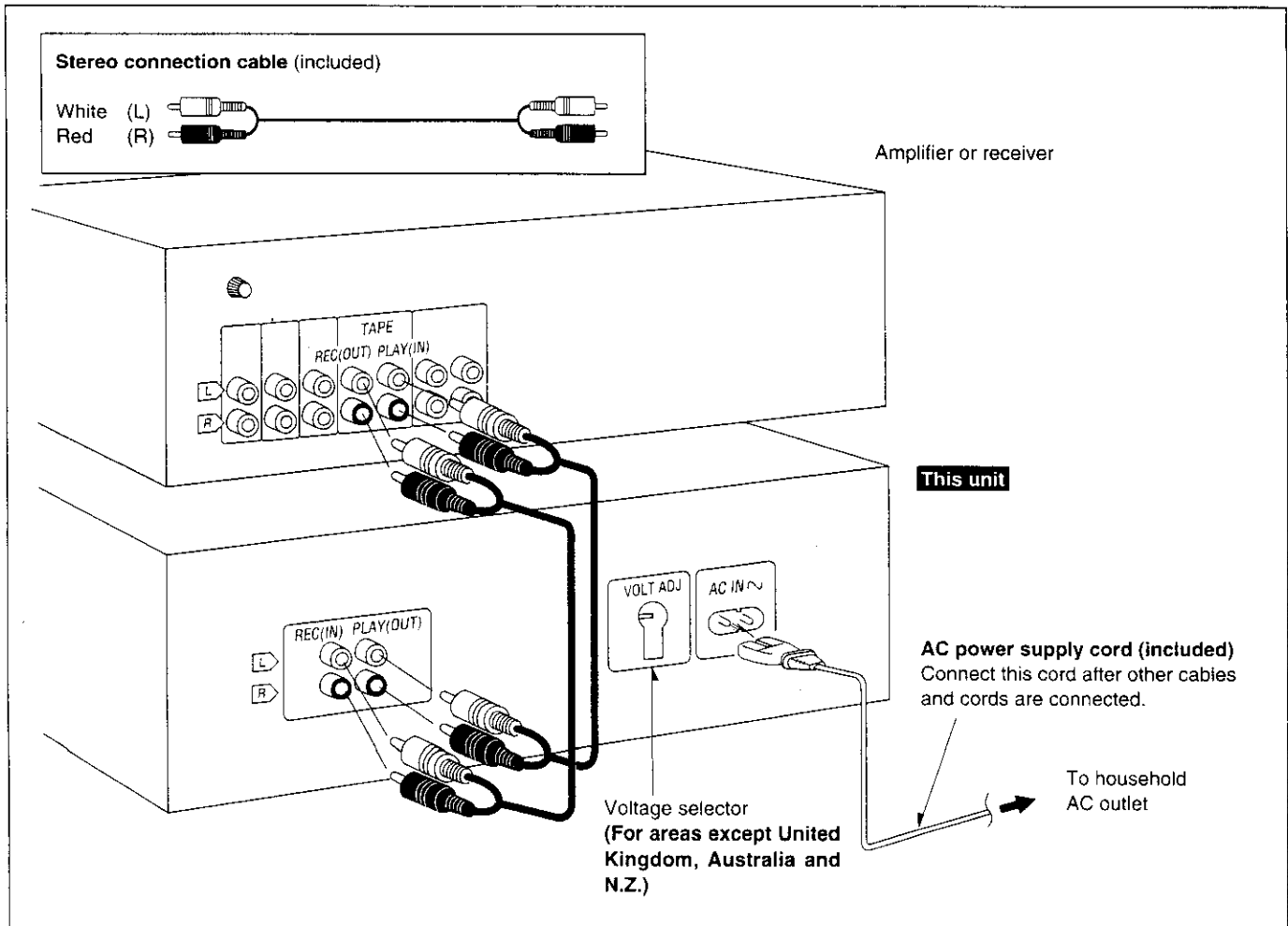

Placements hints

If this unit is placed near a receiver or tuner, a "hum" noise may be heard during tape playback, recording, or AM reception of the receiver or tuner.

If this occurs, leave as much space as possible between the units, or place them where there is the least amount of "hum".

(For areas except Australia and N.Z.)

Insertion of Connector

Even when the connector is perfectly inserted, depending on the type of inlet used, the front part of the connector may jut out as shown in the drawing.

However there is no problem using the unit.

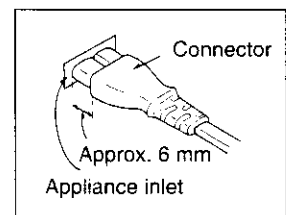

(For areas except United Kingdom, Australia and N.Z.)

If the power plug will not fit your socket, use the power plug adaptor (included).

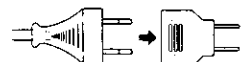

Playback

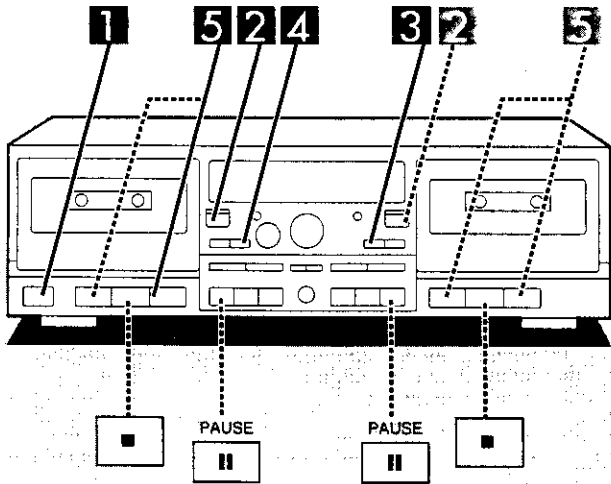

Types of tapes which can be played on this unit:

NORMAL POSITION/TYPE I	<input type="radio"/>
HIGH POSITION/TYPE II	<input type="radio"/>
METAL POSITION/TYPE IV	<input type="radio"/>

The unit automatically identifies the type of tape. The procedures described below are an example of playback on DECK 1.

1 Press [POWER].
(The unit will switch on.)

2 Press [▲ OPEN/CLOSE] and insert the cassette tape.
Press again to close the cassette holder. When the cassette holder is open, pressing [◀], [▶], [◀◀] or [▶▶] will close the holder and begin the desired function.

3 Press [DOLBY NR] to select the appropriate noise-reduction system.
Each time the button is pressed, the indicator will change in the order: **B** → **C** → off.
Select the same type as that used for recording. When playing back a tape which was not recorded using a Dolby NR system, press so that the indicators go off. (→ Page 7.)

4 Press [REVERSE MODE] to select the appropriate reverse mode.
Each time the button is pressed, the indicator will change in the order: **↔** → **↻** → **∞**.
↔ : One side only.
↻ : Both sides repeatedly (up to 8 times).
∞ : Both sides, once only.
(→ "Reverse function" on page 8.)

5 Press [◀] or [▶].
(Playback will begin.)
▶ : To begin from the forward side.
◀ : To begin from the reverse side.

Press the corresponding buttons for DECK 2 to playback on that deck.

To stop playback
Press [■].

To temporarily stop playback
Press [|| PAUSE].
The "PLAY" indicator will flash.
Press once again to resume playback.

Playback

Series playback

Both sides of the tape in DECK 1 will be played, followed by both sides of the tape in DECK 2. (Repeated up to eight times.)

- 1 Press [▲ OPEN/CLOSE] on both decks and insert the cassette tapes.
- 2 Press [DOLBY NR] to select the appropriate noise-reduction system.
- 3 Press [REVERSE MODE] to select the "∞" mode.
- 4 Press [▶] on DECK 1.
(Series playback will begin from the forward side of the tape in DECK 1.)

For your reference:

It is also possible to begin series playback from the reverse side of the tape in DECK 1 or from DECK 2.

Note that for series playback it is not possible to select different types of Dolby NR for DECK 1 and DECK 2. It is recommended that you use two tapes which were recorded using the same type of Dolby NR (or both recorded without Dolby NR).

Dolby noise-reduction

The Dolby noise-reduction system is designed to effectively reduce the annoying high-frequency "hissing" noise which can occur with cassette tapes. During recording, the system functions to increase the high-frequency sound level, and then, during playback, that same portion is weakened to bring it back to the previous level.

This unit includes two types of Dolby noise-reduction systems, the Dolby B NR-type and C NR-type.

Dolby B-type noise-reduction

Noise is reduced to about one-third.

Use this system when playing back tapes recorded by the Dolby-B noise-reduction system, such as prerecorded music tapes, etc.

Dolby C-type noise-reduction

Noise is reduced to about one-tenth.

Use this system for the recording of sound sources that have a wide dynamic range and good tone quality, such as FM broadcasts of live performances, etc., and for playing back such tapes.

Dolby HX-Pro headroom extension

This system improves the maximum output level of the tape's high frequency range, allowing recording without reducing the source's high frequency range.

Along with the unit's noise reduction systems, this system greatly extends dynamic range.

Dolby noise reduction and HX Pro headroom extension manufactured under license from Dolby Laboratories Licensing Corporation. HX Pro originated by Bang & Olufsen.

"DOLBY", the double-D symbol  and "HX PRO" are trademarks of Dolby Laboratories Licensing Corporation.

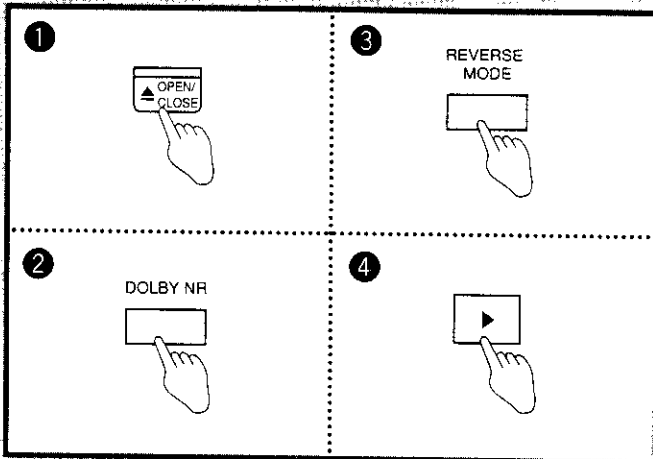
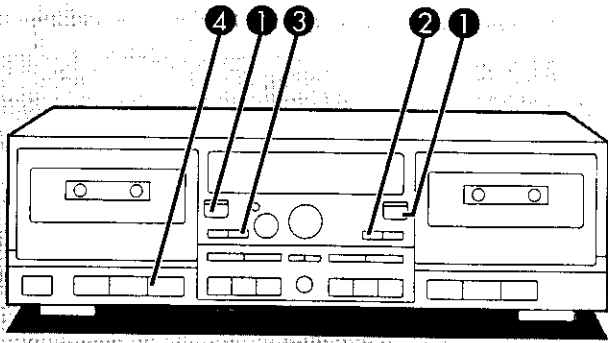

A

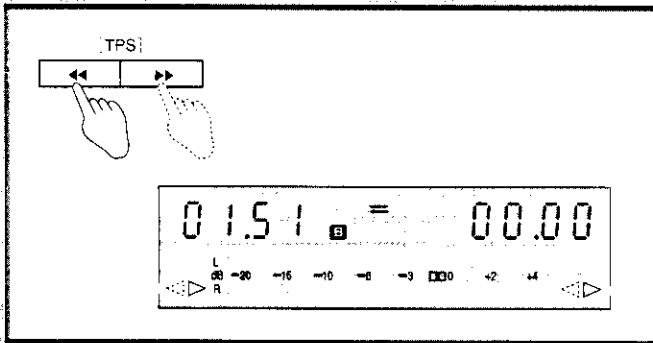
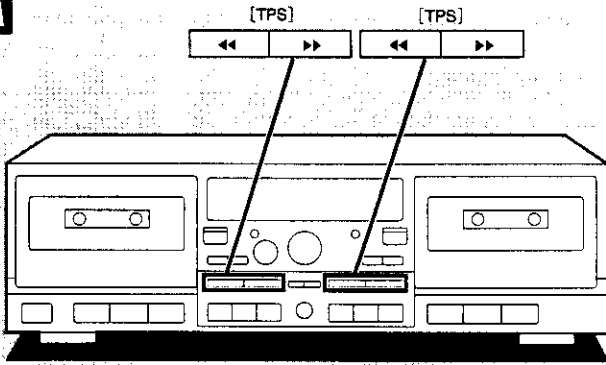

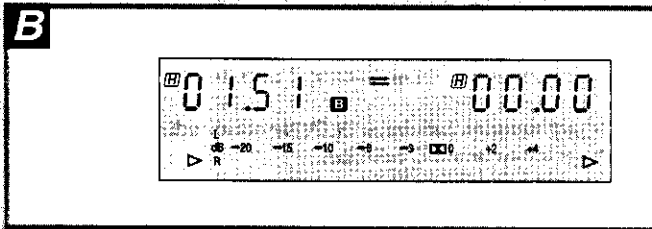

B





Playback

Reverse function

The reverse function on this unit has three modes ( ,  , ).

Read the descriptions below and select the mode as desired.





Mode	Tape travel
	Plays one side of the tape and automatically stops.
	Plays both sides eight times each and automatically stops. (Forward side plays seven times if playback is begun on reverse side.)
	If one deck is loaded Plays both sides once then automatically stops. (Forward side is not played if playback is begun on reverse side.) If both are loaded Plays both sides of the tape in DECK 1 then both sides of DECK 2, then the process is repeated for a total of eight times, automatically stopping at the end. (Tape in DECK 1 plays seven times if play is begun from DECK 2.)

To fast-forward or rewind the tape

[In stop mode]

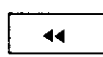
Press [] or [].

Because this unit is capable of playing back both sides of the tape, the operation changes in accordance with the direction of the tape side indicator.

Tape side indicator	Rewind	Fast forward
		
		



- Cassette tapes in DECK 1 and DECK 2 can be advanced or rewound at the same time.

High-speed tape transport **B**

When fast-forwarding from near the beginning of tape or when rewinding from near the end of tape, the tape travel speed will be faster than that during normal fast-forwarding or rewind.

(During high-speed tape transport, the **H** indication will light up.) This high-speed tape transport will also function during TPS.

To return to the normal speed during high-speed tape transport

Press [] or [] corresponding to the current direction of tape travel.

Note

Depending on the amount of tape on the take-up and supply sides, the tape may not be transported at high-speed.

Playback

To find the beginning of a program (TPS)





(TPS: Tape Program Sensor)

[While tape is being played back]

Press [◀◀] or [▶▶].

(The tape will be re-wound or fast-forwarded to the beginning of track, and then playback will automatically begin.)

Because this unit is capable of playing back both sides of the tape, the operation changes in accordance with the direction of the tape side indicator.

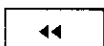
Tape side indicator	Tape returns to the beginning of the track currently being played, and playback begins.	Playback begins from the beginning of the next track.
		
		

- During TPS, the "PLAY" indicator will flash quickly.
- To find the beginning of a track which is several tracks before or after the track currently being played, repeat the procedure until the desired track is found.
- If the reverse mode is set to "↺" or "↻", when the end of the tape is reached, operation will switch to the other side of the tape and TPS will continue to operate.

Note

TPS searches for silent parts of about 4 seconds in length which are normally found between tunes. As a result, it may not function properly in the following cases.

- With short silent parts
- When noise occurs between tunes
- With silent parts found within tunes
- When TPS is started near the beginning or end of a track

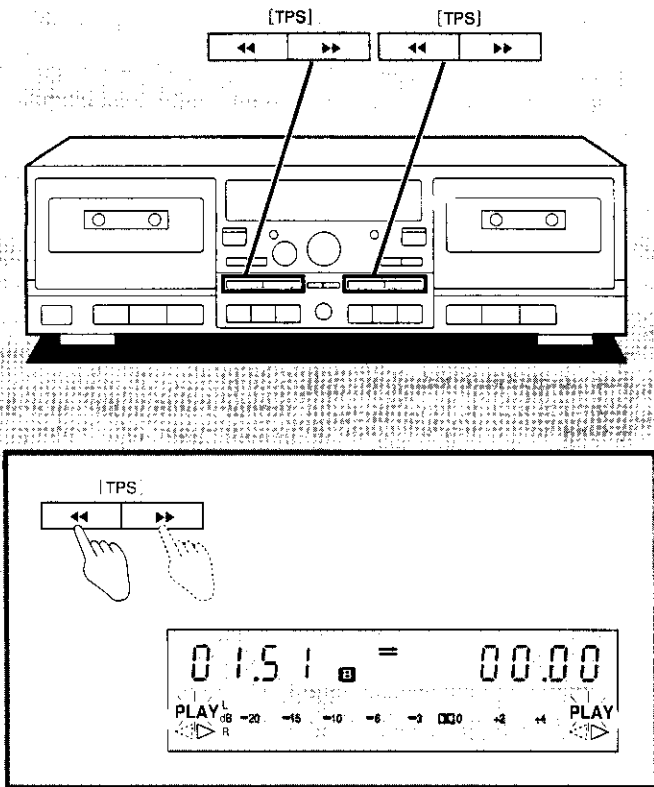

A

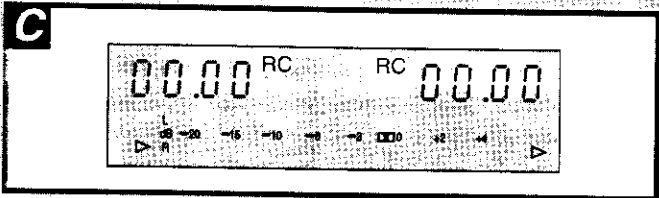
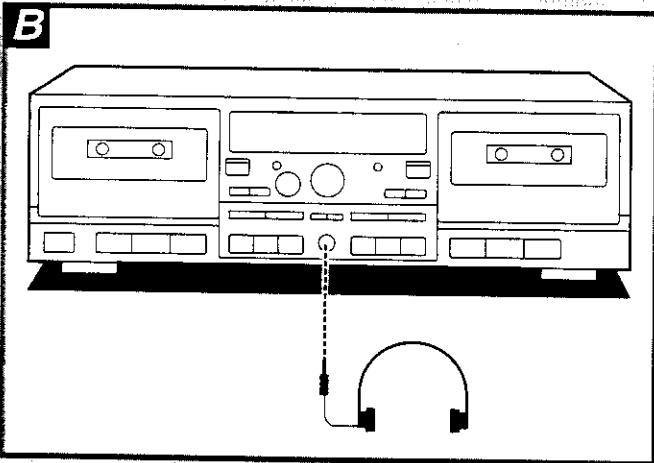
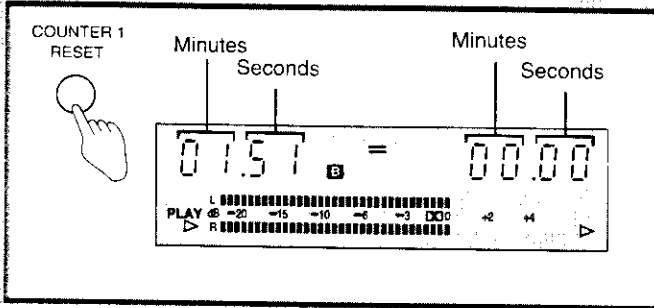
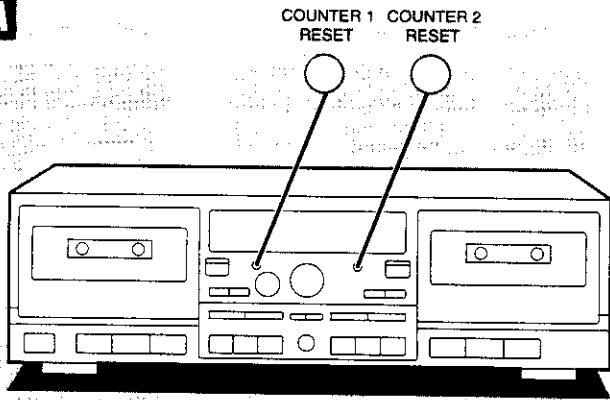

Playback

Linear counter

The linear counter indicates the amount of tape travel as the approximate amount of elapsed time.

To reset the linear counter

Press [COUNTER 1 (2) RESET].

The linear counter indication will return to "00.00".

For your reference:

When the tape is travelling in the reverse direction, the value displayed on the linear counter will count down. After "00.00" is reached, the value then increases, but with a minus sign displayed (example: "-00.08").

Note

The linear counter is not a digital clock. The difference between the actual recording and playback time and the counter display may be anything up to several minutes.

To listen through headphones

Connect the headphones (not included) to the headphone jack.

Plug type: 6.3 mm stereo

Note

Avoid listening for prolonged periods of time to prevent hearing damage.

About the remote control function

The cassette deck can be operated by using the remote control provided with a Technics amplifier or receiver. (For detailed information, refer to the operating instructions of the amplifier or receiver.) Use the remote control within 60 degrees and within 7 meters facing toward this unit. Avoid any obstacles.

During operation from the remote control, the "R.C." indicator will light up.

Recording

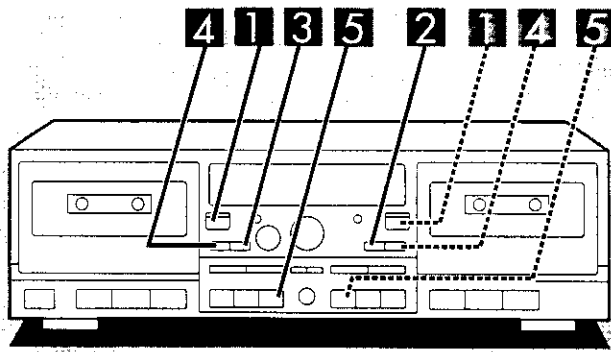

Types of tapes which can be used for recording:

NORMAL POSITION/TYPE I	<input type="radio"/>
HIGH POSITION/TYPE II	<input type="radio"/>
METAL POSITION/TYPE IV	<input type="radio"/>

This unit is equipped with an ATC function (→ page 14) which automatically sets the optimum recording conditions to match the characteristics of the tape being used. It is recommended that you use this function when recording.

Preparation

Wind the tape past the leader tape section so that recording can begin straight away.

The procedures described below are an example of recording on DECK 1.

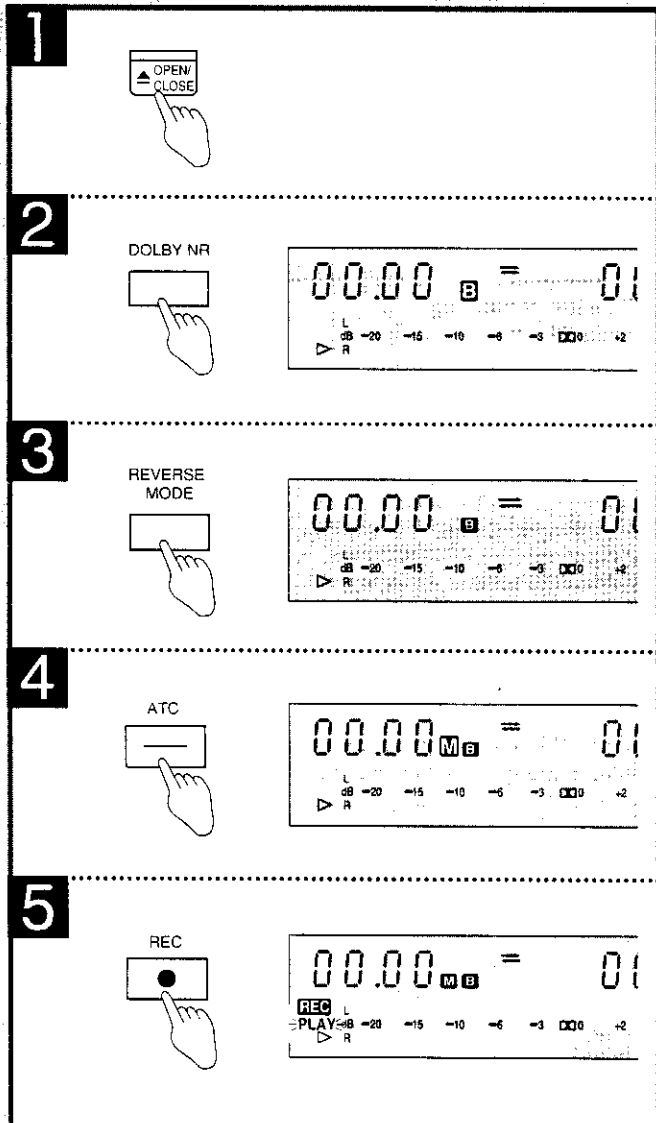

- 1 Press [**▲ OPEN/CLOSE**] and insert the cassette tape to be used for recording.
Press again to close the cassette holder.

- 2 Press [**DOLBY NR**] to select the appropriate noise-reduction system.
Each time the button is pressed, the indicator will change in the order: **B** → **C** → off.

(→ Page 14.)

- 3 Press [**REVERSE MODE**] to select desired reverse mode.
Each time the button is pressed, the indicator will change in the order: **↔** → **↻** → **∞**.

↔ : One side only is recorded.

↻ , **∞** : First the forward side, then the reverse side is recorded.

- 4 Press [**ATC**].
ATC (→ page 14) takes approximately one minute.
On completion, the tape returns to the position ATC began and the unit stops.
The "M" indicator shows ATC has been set.
[Recording can be done without ATC.]

- 5 Press [**● REC**].
(The unit will be in the recording standby mode.)

- 6 Play the source in order to adjust the recording sound.

(Continued on next page)

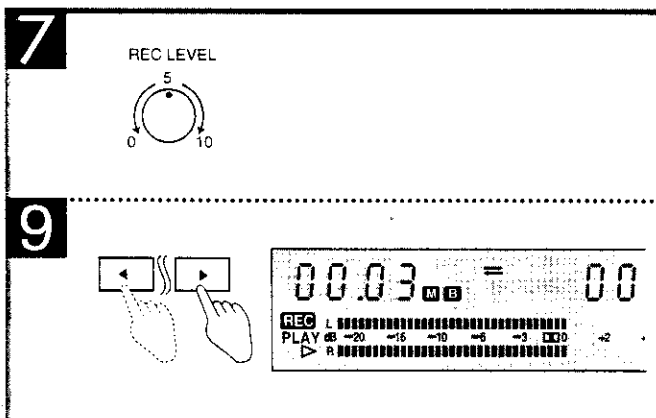
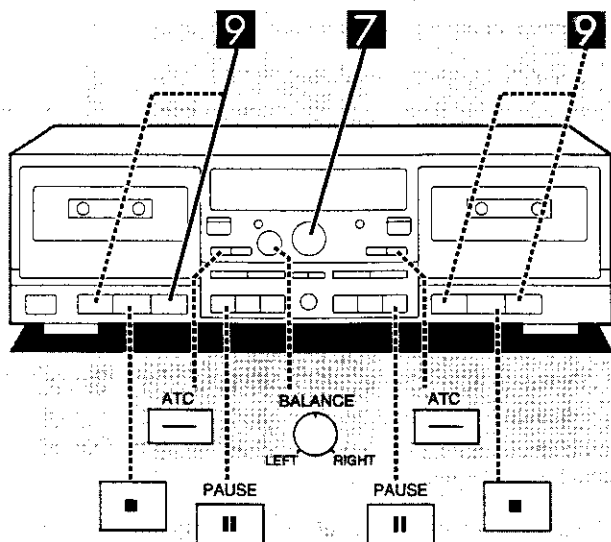

Recording

- 7** Use [REC LEVEL] to adjust the recording level.
(→ Page 14.)
- 8** Stop play of the source.
- 9** Press [◀] or [▶] to begin recording, and play the source to be recorded.

- ▶ : Forward side.
- ◀ : Reverse side.

Note

When recording on both sides of the tape, be sure to press [▶].

Press the corresponding buttons for DECK 2 to record on that deck.

To stop recording

Press [■].

To temporarily stop recording

Press [|| PAUSE].

The "PLAY" indicator will flash.

Press once again to resume recording.

To cancel the ATC settings

[While ATC settings are in progress]

Press [■].

[After ATC settings have been completed]

Press [ATC].

If the "M" indicator begins to flash quickly while the ATC settings are in progress

It indicates that the settings cannot be made for one of the following reasons.

- The tape has reached the leader tape.
- The tape is severely damaged.
- The cassette deck's heads are severely dirty.
- The tape is a non-standard type, such as a metal tape which has no tape type identification hole in the cassette.

Note

- If the cassette holder is opened after the ATC settings have been completed, the settings will be cancelled.
- If the ATC settings are to be made midway through a tape, leave a two second interval after the track prior to where ATC is to begin.

For your reference

[BALANCE] should normally be set to the center position.

Recording

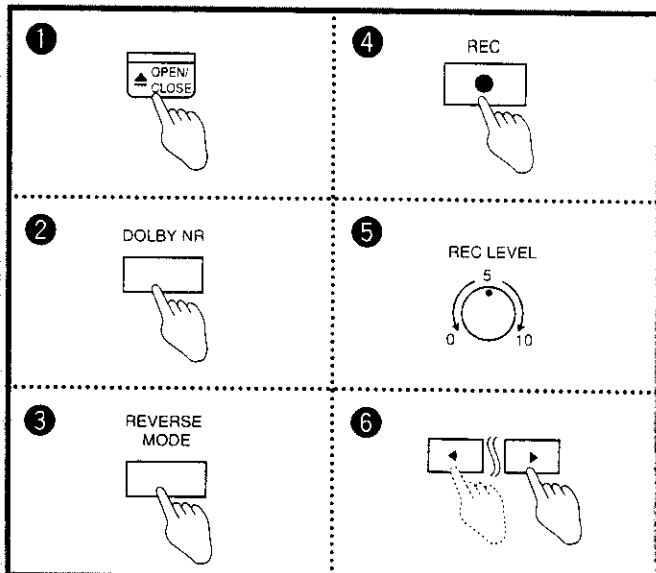
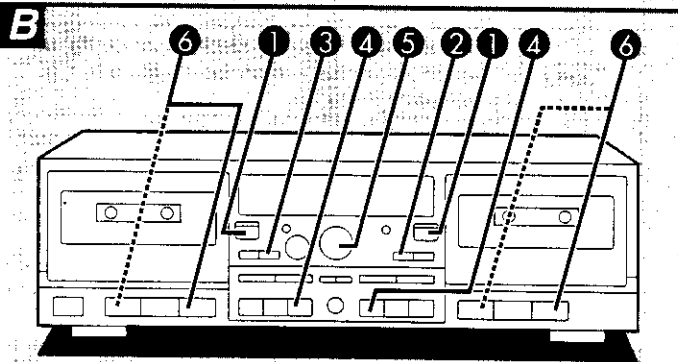
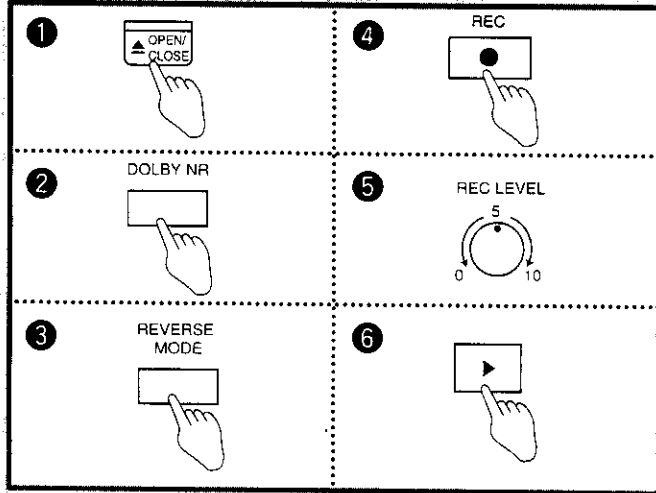
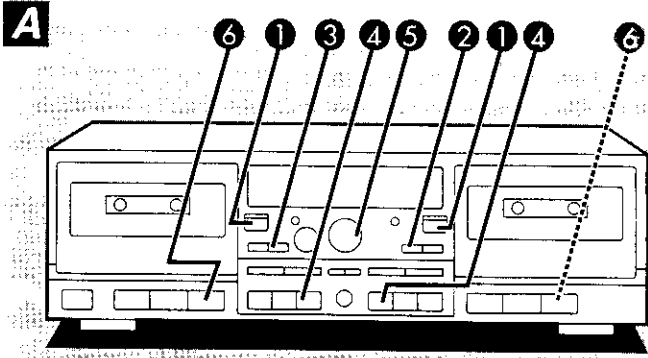

Series recording **A**

The unit records onto both sides of tapes loaded into both decks. Recording can begin on the A side of either deck.

- 1 Press [**▲** OPEN/CLOSE] on both decks, and then insert the cassette tapes to be used for recording.
- 2 Press [DOLBY NR] to select the desired noise-reduction system.
- 3 Press [REVERSE MODE] so that the "↔" indicator illuminates.
If ATC is required, press ATC for DECK 1, allow it to finish, then press ATC for DECK 2.
- 4 Press [**●** REC] on DECK 1 and DECK 2. Both decks will then change to the recording stand-by mode.
- 5 Begin playback of the sound source, and then use [REC LEVEL] to adjust the recording level. Stop playback when adjustments are complete.
- 6 Press [**▶**] on DECK 1 (or DECK 2), and play the source to be recorded.

Parallel recordings **B**

The same sound source can be recorded simultaneously to both DECK 1 and DECK 2.

- 1 Press [**▲** OPEN/CLOSE] on both decks, and then insert the cassette tapes to be used for recording.
- 2 Press [DOLBY NR] to select the desired noise-reduction system.
- 3 Press [REVERSE MODE] so that the "↔" or the "↻" indicator illuminates.
If ATC is required, press ATC for DECK 1, allow it to finish, then press ATC for DECK 2.
- 4 Press [**●** REC] on DECK 1 and DECK 2.
- 5 Begin playback of the sound source, and then use [REC LEVEL] to adjust the recording level. Stop playback when adjustments are complete.
- 6 Press [**◀**] or [**▶**] on DECK 1 and DECK 2 at the same time, and play the source to be recorded.

Note

- The same direction of tape movement for recording should be selected for each tape deck.
- When recording on both sides of the tape, be sure to press [**▶**].

A

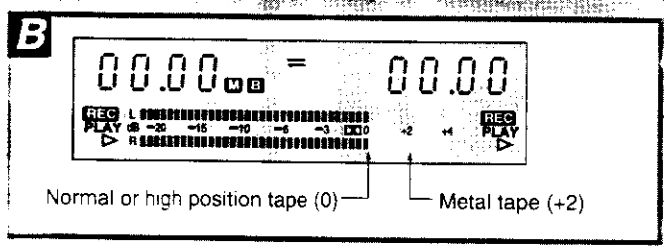
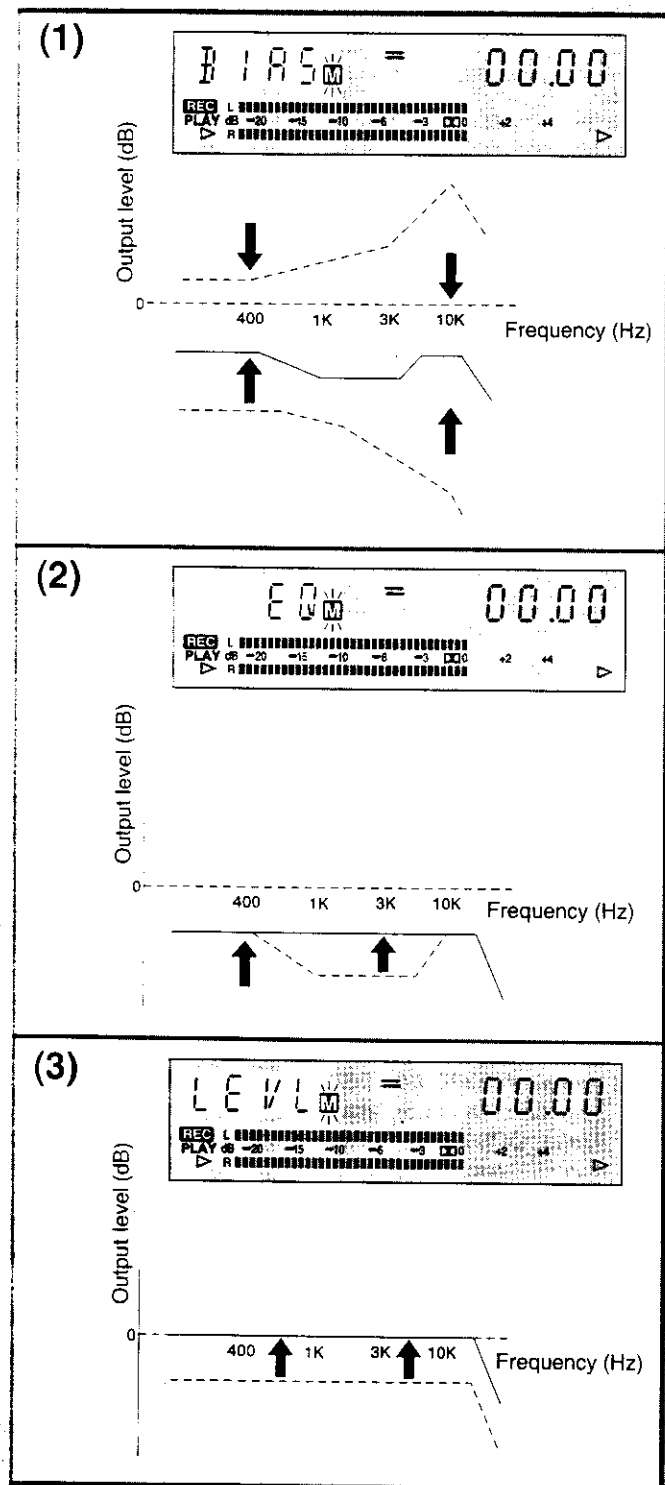

Recording

ATC

A

ATC (auto tape calibration) records a test signal in order to automatically set the bias, equalizer and recording/playback level to the optimum recording conditions in accordance with the characteristics of the tape being used.

The illustrations show the conditions of the display and the operation of the unit while the ATC settings are being made.

Example: Performing ATC on DECK 1

(1) Bias adjustment

The bias is adjusted so that the output level is the same at 400 Hz and at 10 kHz.

(2) Equalizer adjustment

The equalizer is adjusted so that the output level is the same at 400 Hz and at 3 kHz.

(3) Level adjustment

The tape sensitivity is compensated so that the recording input level and the playback output level are the same.

Selecting the Dolby NR type

The Dolby NR effect can be obtained by using the same type of Dolby NR during both recording and playback.

Refer to the following table when selecting the type (either B or C).

Type B	Use this type when the deck on which the tape will be played back is equipped with only type B Dolby NR.
Type C	Use this type when the deck on which the tape will be played back is equipped with type C Dolby NR. (For example, when this unit is also going to be used to play back the tape.)

Recording level adjustment

B

If the recording level is too high, there will be distortion in the recorded sounds, and if it is too low, the hiss noise inherent to recording tapes will become noticeable.

In order to make high-quality recordings, use [REC LEVEL] to adjust so the highest values of the input level indicated by the level meter do not exceed the standard recording level (the number indicated in parentheses in the illustration) for the type of tape being used.

Tape-to-tape recording

Use DECK 2 to record the sound being played back on DECK 1.

Preparation

Wind the tape past the leader tape section so that recording can begin straight away.

- 1 Press [▲ OPEN/CLOSE] on both decks and insert the cassette tapes.

DECK 1: For playback

DECK 2: For recording

Press again to close the cassette holder.

- 2 Press [REVERSE MODE] to select the desired reverse mode.

Each time the button is pressed, the indicator will change in the order: 

 : One side only is recorded.

 : First the forward side, then the reverse side is recorded.
The playback tape is played up to eight times until the recording tape finishes.

 : First the forward side, then the reverse side is recorded.

Note

To record on only one side of the tape, set the tape side indicators (< or >) on DECK 1 and DECK 2 in accordance with the tape sides to be played back and recorded.

To record on both sides of the tape, set the tape side indicators on both DECK 1 and DECK 2 to the forward side (>).

- 3 Press [SPEED] to select a recording speed.

Each time the button is pressed, the indicators will change in the order: X1 → X2 → off.

X1 : Normal speed

X2 : Double speed

- 4 Press [ATC] on DECK 2.

(The ATC function will enter the stand-by mode.)

[Recording is also possible without performing ATC.]

- 5 Press [SYNCHRO START].

(ATC will begin, and when it is completed, recording will begin.)

To stop recording

Press [■] on DECK 2.

Note

- In order to avoid operation errors later, be sure to switch off [SPEED] (the "X1" and "X2" indicator will go out) after the tape-to-tape recording has finished.
- During speed recording (X2), the unit picks up interference from televisions easier, so turn the television off or separate the two units.

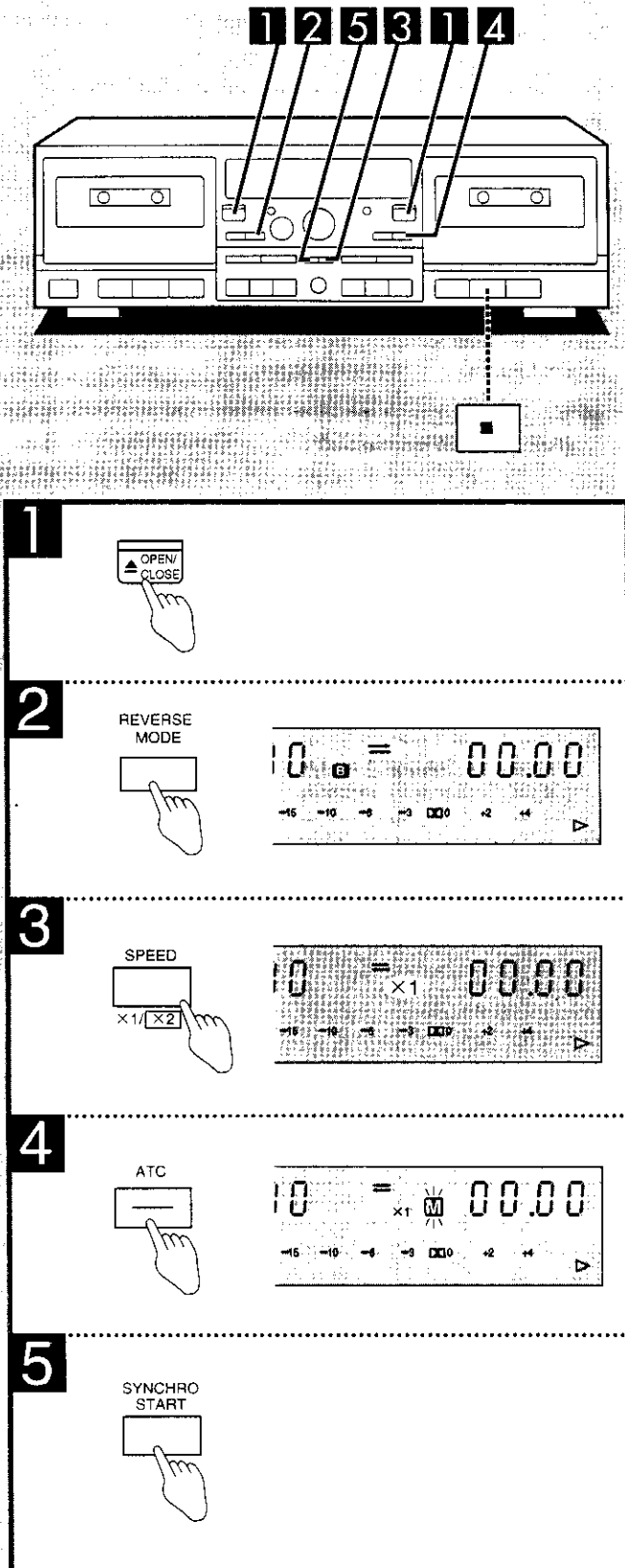

Recording

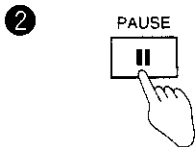
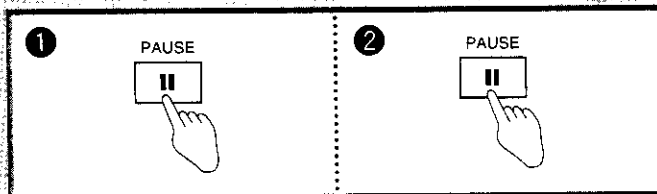
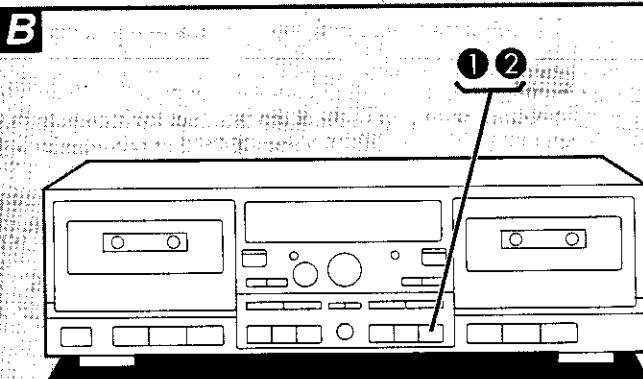
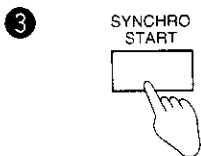
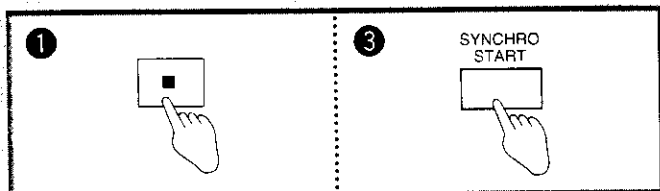
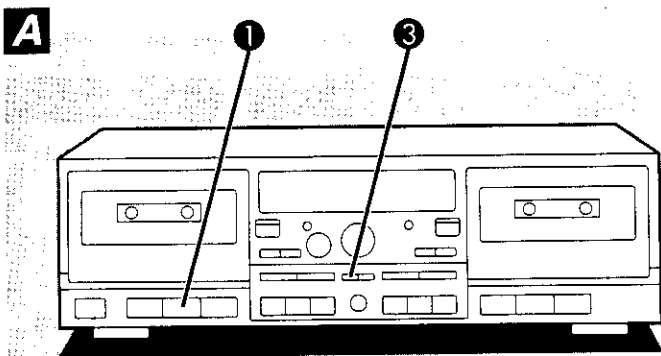

To record selected tracks **A**

- [During recording]
Press [■] on DECK 1.
(DECK 1 will stop, and DECK 2 will record a 4-second silent interval and then enter the recording standby mode.)
- Operate DECK 1 to find the track you wish to record.**
It is also possible to change the playback tape at this time.
For your reference:
TPS is useful for finding the beginning of the track.
(→ Page 9.)
- Press [SYNCHRO START].**
(Recording will resume.)

To cut unwanted parts during recording **B**

- [During recording]
Press [|| PAUSE] on DECK 2.
(DECK 2, which was recording, will enter the pause mode, and DECK 1 will continue playback.)
- [When DECK 1 reaches a part you wish to record]
Press [|| PAUSE] on DECK 2.
(DECK 2 will resume recording.)

For your reference:

- The recording level and the Dolby effect will be recorded as they are on the tape being played back.
- The signal being recorded does not pass through the amplifier or receiver, so it is possible to select another source to listen to while the recording is being made.

Your attention is drawn to the fact that recording pre-recorded tapes or discs or other published or broadcast material may infringe copyright laws.

To make a silent interval

A silent interval of 4 seconds or more can be provided between tracks. This function is useful for playing back on decks which can skip to the beginning of tracks, and for cutting unwanted sound from commercials.

To make a 4-second silent interval **A**

Press [**○** AUTO REC MUTE] momentarily while a recording is being made.

A 4-second silent interval will be recorded, and the unit will automatically be set to the recording standby mode.

To make a silent interval of more than 4 seconds **B**

Press and hold [**○** AUTO REC MUTE] for the necessary number of seconds while a recording is being made.

The unit will change to the recording stand-by mode when the button is released.

To resume recording **C**

Press either [**◀**] or [**▶**], corresponding to the indicator which is lit.

To erase recorded sound **D**

- 1 Press [**▲** OPEN/CLOSE] on DECK 1 (or DECK 2) and insert the recorded cassette tape.
- 2 Press [DOLBY NR] so that the Dolby NR indicators ("B" and "C") are off.
- 3 Press [REVERSE MODE] to select the desired reverse mode.
- 4 Set [REC LEVEL] to "0".
- 5 Press [**●** REC].
- 6 Press [**◀**] or [**▶**] to begin erasing the tape.

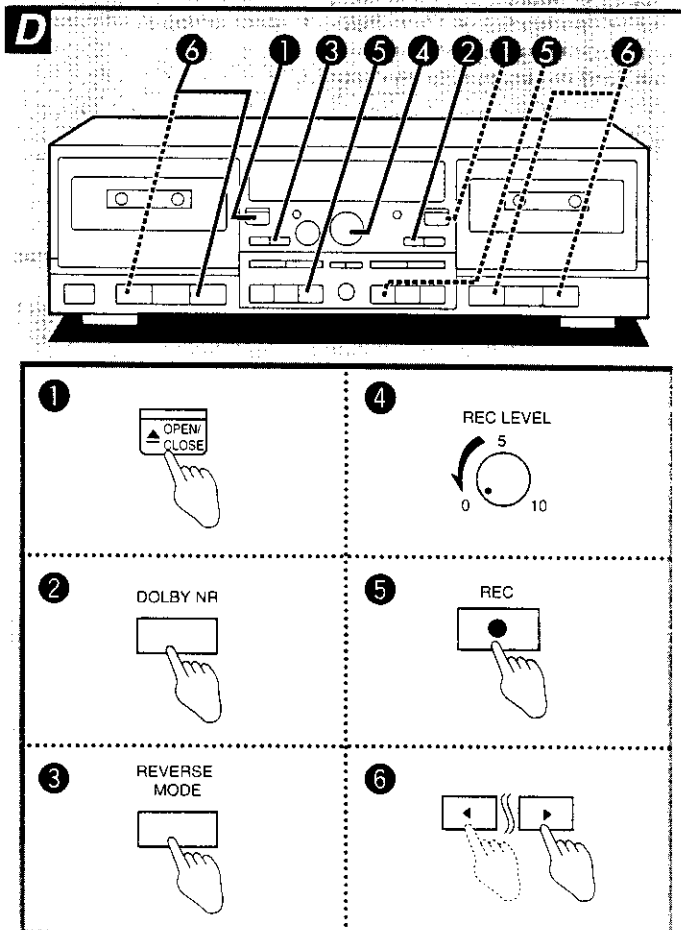
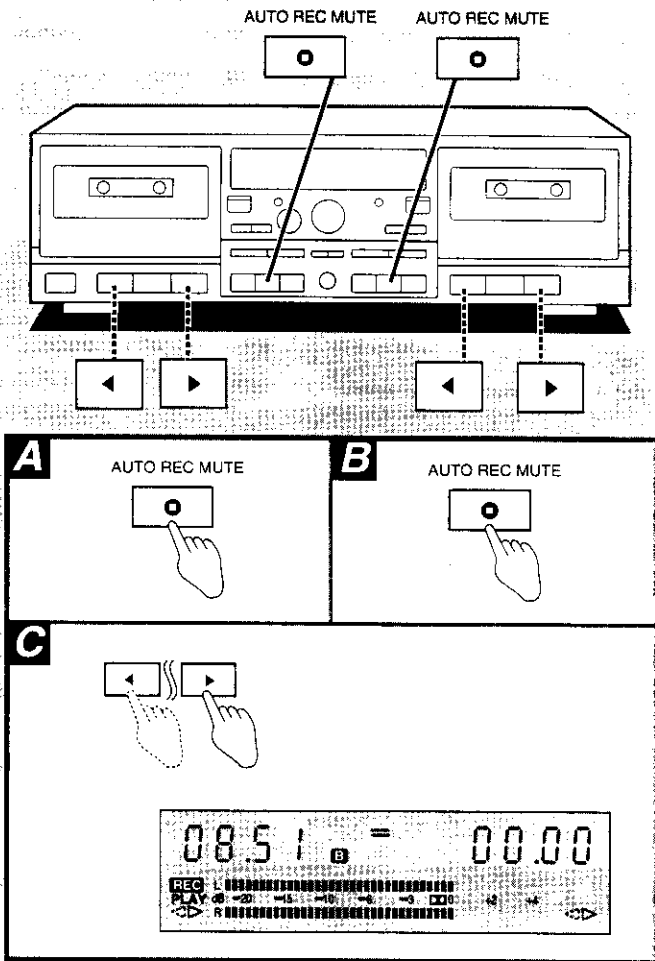

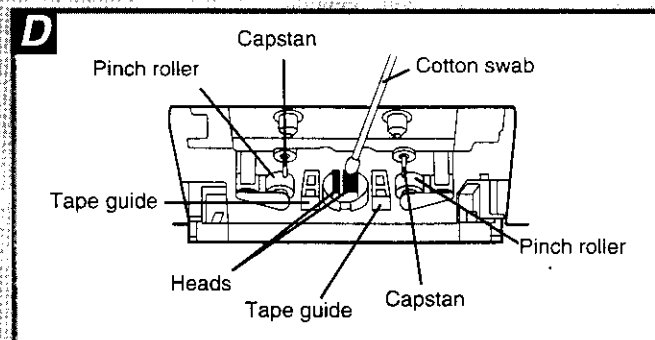
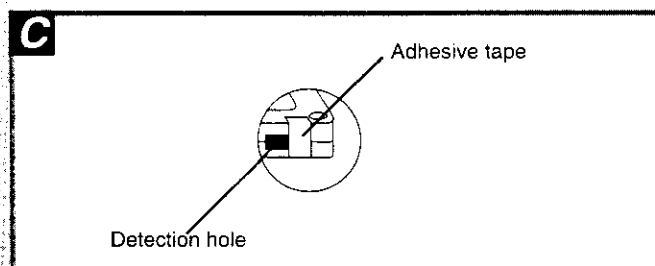
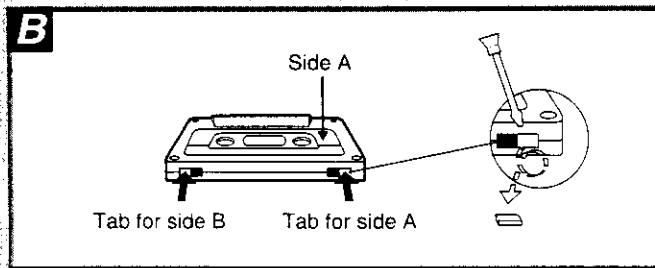
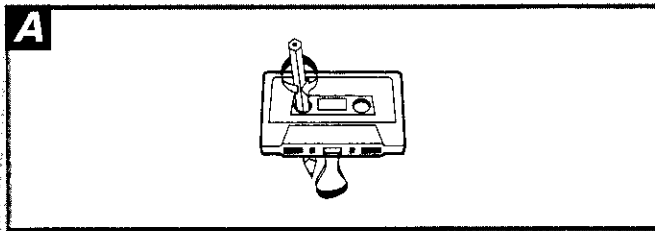

Concerning cassette tapes

Selection of cassette tapes

Tapes can get caught on the capstans. Use caution with the following types of tapes.

Cassette tapes exceeding 100 minutes

These tapes are made of a thin material. Do not repeatedly advance and stop the tape, fast-forward it or rewind it.

Endless tapes

For this unit, it is recommended to use tapes which are appropriate to the auto reverse mechanism.

Always read the instructions provided with your tapes.

Tape slack

Tape slack may cause the tape to break. Use a pencil or similar object to take up the slack.

Erasure prevention

Remove the tabs with a screwdriver or similar object. **B**
To re-record on a protected cassette, cover the slot with adhesive tape. **C**
Do not cover the detection holes on high position and metal tapes.

Storage precautions

Do not place or store tapes in the following places.

- In high temperature (35°C or higher) or high humidity (80% or higher) areas.
- In a strong magnetic field (near a speaker, on top of a TV, etc.). This can erase a recording.
- Locations exposed to direct sunlight.

Maintenance

Head care

To assure good sound quality for recording and playback, be sure to clean the heads after approximately every 10 hours of use.

- 1) Press [▲ OPEN /CLOSE] to open the cassette holder.
- 2) **Switch off the power of the cassette deck.**
- 3) Clean the heads, pinch roller and the capstan shaft with a cotton swab (or with a soft, lint-free cloth) slightly moistened with isopropyl alcohol.
Do not use any solution other than alcohol for head cleaning.

If the surfaces are dirty

To clean this unit, wipe with a soft, dry cloth.

If the surfaces are extremely dirty, use a soft cloth dipped in a soap-and-water solution or a weak detergent solution.

- Never use alcohol, paint thinner or benzine to clean this unit.
- Before using chemically impregnated cloth, read the instructions that came with the cloth carefully.

Troubleshooting guide

Before requesting service for this unit, check the chart below for a possible cause of the problem you are experiencing. Some simple checks or a minor adjustment on your part may eliminate the problem and restore proper operation.

If you are in doubt about some of the check points, or if the remedies indicated in the chart do not solve the problem, refer to the directory of Authorized Service Centers (enclosed with this unit) to locate a convenient service center, or consult your dealer for instructions.

Reference pages indicated in black circles. (For example: 18)

Problem	Probable cause(s)	Suggested remedy
Tape moves but no sound is heard.	The volume control of the amplifier or receiver is set to its minimum position.	• Adjust the volume control to the desired level.
	The input selector of the amplifier or receiver is not set to the "TAPE" position.	• Set to the "TAPE" position.
Distorted sound.	The recording level is too high.	• Select the appropriate recording level.
Previously recorded sound has not been erased.	Erase head is dirty.	• Clean the head. (18)
Sound output is hoarse or unsteady.	Heads are dirty.	• Clean the heads. (18)
	Tape is damaged.	• Test with another tape. Discard the damaged tape if there is no problem with the test tape.
Poor sound quality (especially in the high treble and low bass ranges).	The correct Dolby noise-reduction mode is not set.	• Set to the correct mode. (6, 7)
Sound is low, poor tone, intermittent sound, noise.	Heads, capstan and/or pinch roller are dirty or tape is damaged.	• Clean the heads, capstan and/or pinch roller, or try a new cassette. (18)
There is a lot of noise, and the treble is drowned out.	The heads have been magnetized.	• Demagnetize the heads with a commercially sold magnetic eraser.
A "hum" noise is heard during tape playback or recording.	This unit is placed too close to a receiver, amplifier or tuner.	• Leave as much space as possible between the units, or place them where there is the least amount of "hum".
Recording is not possible.	[REC REVEL] is at the "0" position.	• Select the appropriate recording level. (12)
	One of the tape-to-tape recording-speed indicators ("X1" or "[X2]") is illuminated.	• Switch OFF whichever tape-to-tape recording speed indicator is illuminated (by pressing [SPEED]). (15)
TV noise is accidentally recorded.	This unit is near a TV.	• Try placing this unit further away from a TV.

Technical specifications

■ CASSETTE DECK SECTION

Deck system	Stereo cassette deck
Track system	4-track, 2-channel
Recording system	AC bias
Bias frequency	80 kHz
Erasing system	AC erase
Heads	
DECK 1	Recording/Playback head (Permalloy)×1 Erasing head (Double-Gap ferrite)×1
DECK 2	Recording/Playback head (Permalloy)×1 Erasing head (Double-Gap ferrite)×1
Motors	
DECK 1	Capstan drive (DC Servo Motor)×1 Reel table drive (DC Motor)×1
DECK 2	Capstan drive (DC Servo Motor)×1 Reel table drive (DC Motor)×1
Tape speed	4.8 cm/s
Wow and flutter	0.07% (WRMS) ±0.2% (DIN)
Fast forward and rewind times	Approx. 50 seconds with C-60 cassette tape
Frequency response (Dolby NR off)	
TYPE I (NORMAL)	40 Hz-15 kHz, ±3 dB 20 Hz-16 kHz (DIN)
TYPE II (HIGH)	40 Hz-15 kHz, ±3 dB 20 Hz-16 kHz (DIN)
TYPE IV (METAL)	40 Hz-16 kHz, ±3 dB 20 Hz-17 kHz (DIN)

S/N (signal level=max recording level, TYPE II type tape)

NR off	56 dB (A weighted)
Dolby B NR on	66 dB (A weighted)
Dolby C NR on	74 dB (A weighted)
Input sensitivity and impedance	
REC (IN)	100 mV/47 kΩ
Output voltage and impedance	
PLAY (OUT)	500 mV/500 Ω
HEADPHONES	30 mV (8 Ω) (Load impedance 8 Ω-600 Ω)

■ GENERAL

Power supply	
For United Kingdom, Australia and N.Z.	AC 230-240 V, 50/60 Hz
For others	AC 110 V/127 V/220 V/230-240 V, 50/60 Hz
Power consumption	
For United Kingdom, Australia and N.Z.	28 W
For others	32 W
	3.8 W (Remocon Standby)
	1.9 W (Power Standby)
Dimensions (W×H×D)	430×136×285 mm
Weight	4.4 kg

Note:

Specifications are subject to change without notice.
Weight and dimensions are approximate.

Free Manuals Download Website

<http://myh66.com>

<http://usermanuals.us>

<http://www.somanuals.com>

<http://www.4manuals.cc>

<http://www.manual-lib.com>

<http://www.404manual.com>

<http://www.luxmanual.com>

<http://aubethermostatmanual.com>

Golf course search by state

<http://golfingnear.com>

Email search by domain

<http://emailbydomain.com>

Auto manuals search

<http://auto.somanuals.com>

TV manuals search

<http://tv.somanuals.com>