

# Technics

## Stereo Synthesizer Tuner ST-GT350

### Operating Instructions

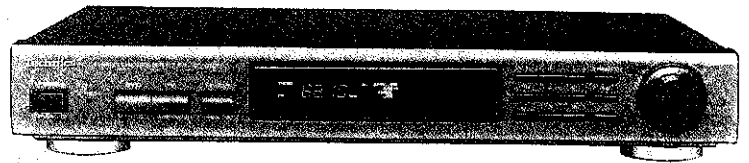

Before connecting, operating or adjusting this product, please read these instructions completely.



GC GN

RQT2350-L

# Dear Customer

Thank you for purchasing this Technics product. For optimum performance and safety, please read these instructions carefully.

## Contents

<b>Technical specifications</b> .....	<b>2</b>
<b>Suggestions for safety</b> .....	<b>3</b>
<b>Front panel controls</b> .....	<b>4</b>
<b>Accessories</b> .....	<b>4</b>
<b>Connections</b> .....	<b>5</b>
<hr/>	
<b>Receiving radio broadcasts</b> .....	<b>8</b>
To lock a broadcast station being received .....	9
If noise is excessive in the FM stereo mode .....	9
To check the FM signal strength .....	9
<b>Preset tuning</b> .....	<b>10</b>
Automatic memory presetting .....	10
Manual memory presetting .....	11
To listen to preset broadcast stations .....	11
<hr/>	
<b>Troubleshooting guide</b> .....	<b>Back cover</b>

For areas except Australia and N.Z.

### CAUTION:

The AC voltage is different according to the area.

Be sure to set the proper voltage in your area before use.

(For details, please refer to the page 7.)

For Australia and N.Z.

THIS TUNER/RECEIVER IS CAPABLE OF RECEIVING THE NEW AM STEREO BROADCASTS FROM THE AM BAND RADIO STATIONS.

HOWEVER LIKE MANY TUNERS AND RECEIVERS CURRENTLY AVAILABLE ON THE MARKET IT WILL REPRODUCE THIS AM STEREO SIGNAL ONLY IN AM MONO, WHICH, IN EFFECT, IS OF NO LESSER QUALITY THAN YOUR EXISTING AM MONO TUNER/RECEIVER.

## Technical specifications (DIN 45 500)

### FM TUNER SECTION

<b>Frequency range</b>	87.50–108.00 MHz (0.05 MHz steps)
<b>Sensitivity</b>	1.5 $\mu$ V (IHF, usable)
S/N 30 dB	1.3 $\mu$ V (75 $\Omega$ )
S/N 26 dB	1.2 $\mu$ V (75 $\Omega$ )
S/N 20 dB	0.9 $\mu$ V (75 $\Omega$ )
<b>IHF 46 dB stereo quieting sensitivity</b>	28 $\mu$ V (75 $\Omega$ )
<b>Total harmonic distortion</b>	
<b>MONO</b>	0.2%
<b>STEREO</b>	0.3%
<b>S/N</b>	
<b>MONO</b>	70 dB (75 dB, IHF)
<b>STEREO</b>	65 dB (70 dB, IHF)
<b>Frequency response</b>	20 Hz–15 kHz, +0.5 to –1.5 dB
<b>Alternate channel selectivity</b>	
$\pm$ 400 kHz	65 dB
<b>Capture ratio</b>	1.0 dB
<b>Image rejection at 98 MHz</b>	45 dB
<b>IF rejection at 98 MHz</b>	90 dB
<b>Spurious response rejection at 98 MHz</b>	75 dB
<b>AM suppression</b>	55 dB
<b>Stereo separation</b>	
1 kHz	40 dB
<b>Carrier leak</b>	
19 kHz	–30 dB (–35 dB, IHF)
38 kHz	–50 dB (–55 dB, IHF)
<b>Channel balance (250 Hz–6.3 kHz)</b>	$\pm$ 1.5 dB
<b>Limiting point</b>	1.2 $\mu$ V
<b>Bandwidth</b>	
<b>IF amplifier</b>	180 kHz
<b>FM demodulator</b>	1000 kHz
<b>Antenna terminal(s)</b>	75 $\Omega$ (unbalanced)

### AM TUNER SECTION

<b>Frequency range</b>	522–1611 kHz (9 kHz steps) 530–1620 kHz (10 kHz steps)
<b>Sensitivity (S/N 20 dB) at 999 kHz</b>	20 $\mu$ V, 600 $\mu$ V/m
<b>Selectivity (<math>\pm</math>9 kHz) at 999 kHz</b>	40 dB
<b>Image rejection at 999 kHz</b>	40 dB
<b>IF rejection at 999 kHz</b>	50 dB

### GENERAL

<b>Output voltage</b>	0.3 V (0.6 V, IHF)
<b>Power consumption</b>	9 W
<b>Power supply</b>	
<b>For Australia and N.Z.</b>	AC 50/60 Hz, 230–240 V
<b>For others</b>	AC 50/60 Hz, 110–127 V/220–240 V
<b>Dimensions (W <math>\times</math> H <math>\times</math> D)</b>	430 $\times$ 69.3 $\times$ 301 mm
<b>Weight</b>	2.6 kg

### Notes:

- Specifications are subject to change without notice. Weight and dimensions are approximate.
- Total harmonic distortion is measured by the digital spectrum analyzer.

# Suggestions for safety

---

## Placement

---

Avoid placing the unit in areas of:

- direct sunlight
- high temperature
- high humidity
- excessive vibration
- uneven surfaces. (Place the unit on a flat level surface).

Such conditions might damage the cabinet and/or other component parts and thereby shorten the unit's service life.

---

## Ventilation

---

Place the unit in a well ventilated position at least 10 cms away from wall surfaces etc.

---

## Stacking

---

Never place heavy items on top of the unit or the power cord.

---

## Voltage

---

- It is very dangerous to use an AC power source of high voltage such as for an air conditioner.  
A fire might be caused by such a connection.
- A DC power source can not be used.  
Be sure to check the power source carefully, especially on a ship or other place where DC is used.

---

## Power cord protection

---

- Avoid cuts, scratches or poor connection of the AC mains cord, as this may result in fire or electric shock hazard.  
Excessive bending, pulling or slicing of the cord should also be avoided.
- Do not pull on the cord when you are disconnecting the power, as this could cause an electric shock. Grasp the plug firmly when you disconnect the power supply.
- Never touch the plug with wet hands or a serious electric shock could result.

---

## Foreign materials

---

- Ensure that no foreign objects, such as needles, coins, screwdrivers etc, accidentally fall into the unit or through the ventilation holes.  
Otherwise, a serious electric shock or malfunction could occur.
- Be extremely careful about spilling water or liquid on/into the unit, as a fire or electric shock could occur.  
(Disconnect the power plug and contact your dealer immediately if this occurs.)
- Avoid spraying insecticides onto the unit as they contain flammable gases which can be ignited.
- Insecticides, alcohol, paint thinner and similar chemicals should never be used to clean the unit as they can cause flaking or cloudiness to the cabinet finish.

---

## Maintenance

---

Clean the cabinet, panel and controls with a soft cloth lightly moistened with mild detergent solution.

Do not use any type of abrasive pad, scouring powder or solvent such as alcohol or benzine.

---

## Service

---

- Never attempt to repair, disassemble or reconstruct the unit if there seems to be a problem.  
A serious electric shock could result if you ignore this precautionary measure.
- If a problem occurs during operation (the sound is interrupted, indicators fail to illuminate, smoke is detected, etc) contact your dealer or Authorised Service Center immediately.
- Disconnect the power supply if the unit will not be used for a long time. Otherwise the operation life could be shortened.

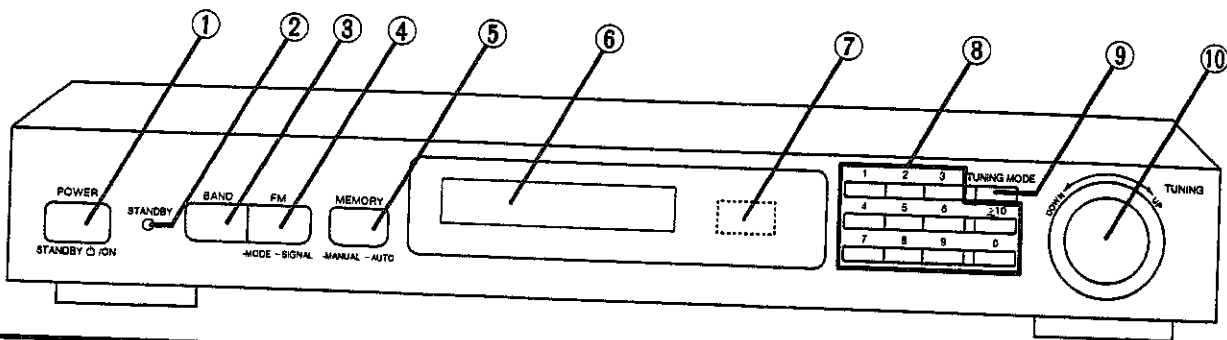

# Front panel controls



No.	Name	Ref. page
①	Power "STANDBY $\text{⏻}$ / ON" switch (POWER, STANDBY $\text{⏻}$ / ON)	8
②	"STANDBY" indicator (STANDBY)	—
③	Band select button (BAND)	8
④	FM mode select/FM signal-strength indication button (FM)	9
⑤	Memory button (MEMORY)	10,11

No.	Name	Ref. page
⑥	Display	—
⑦	Remote control signal sensor	—
The ST-GT350 can be operated using the remote control provided with a Technics amplifier. You can also turn this unit on and off by using the remote control included with the amplifier compatible with the New Technics Remote Control System. Amplifier: SU-V500/A900MK2 (as of April, 1994) [See the operating instructions of the amplifier for details.]		
⑧	Preset-tuning buttons (1-0, $\geq 10$ )	11
⑨	Tuning mode select button (TUNING MODE)	8
⑩	Tuning control (TUNING)	8

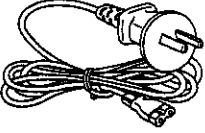
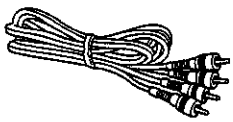
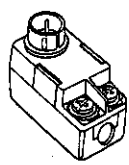
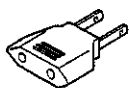
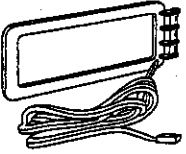
## Accessories

<input type="checkbox"/> AC power supply cord (For Australia and N.Z.)	1	<input type="checkbox"/> Stereo connection cable	1
			
<input type="checkbox"/> AM loop antenna set		<input type="checkbox"/> Antenna plug	1
AM loop antenna	1		
AM antenna holder	1	<input type="checkbox"/> Power plug adaptor (Not supplied for Australia and N.Z.)	1
Screw	1		
			
<input type="checkbox"/> FM indoor antenna	1		
			

# Connections

## To connect the FM antenna

### FM indoor antenna (included)

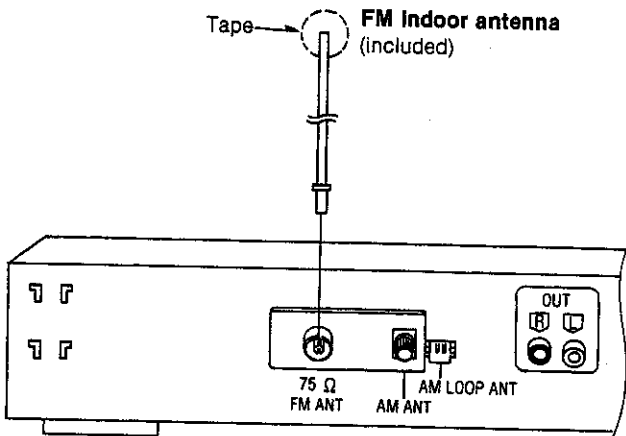

Attach to a wall (using a tape) facing in the direction of best reception.

#### For best reception sound quality:

Find the optimum height and direction that gives the maximum signal reception strength.

#### Note

If the FM indoor antenna does not provide satisfactory reception, an outdoor antenna should be used.

### FM outdoor antenna (not included)

The outdoor antenna may be required in a mountainous region, or if this unit is located inside a reinforced-concrete building, etc. Disconnect the FM indoor antenna if an FM outdoor antenna is installed.

#### FM outdoor antenna (not included)

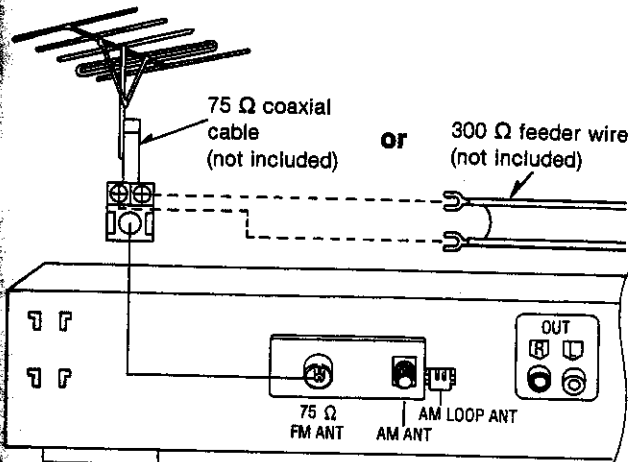

#### Note

An outdoor antenna should be installed by a competent technician only.

### How to use the antenna plug (included)

Two types of wire are most commonly used for connection from the antenna: 300 Ω parallel feeder wire or 75 Ω coaxial cable. For best resistance to outside interference, the use of 75 Ω coaxial cable is suggested.

### To connect a 75 Ω coaxial cable

- 1 Remove a piece of the outer vinyl insulator.



- 2 Remove the cover while pulling the tabs.

#### Note

If the tabs are pulled too hard, the casing may be damaged.



- 3 Remove the lead wire.
- 4 Clamp the lead wire with the plastic bar.

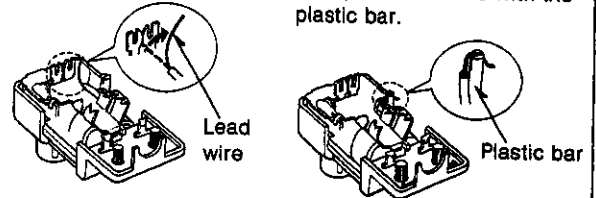

- 5 Install the coaxial cable.

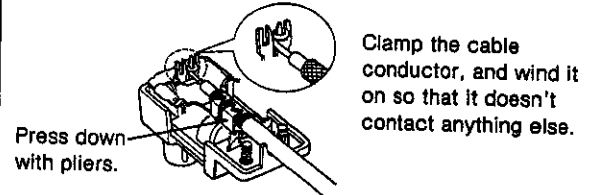

- 6 Attach the cover.

### To connect a 300 Ω feeder wire

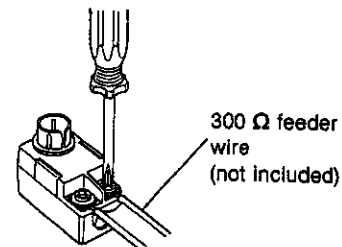

Loosen the screw to connect the feeder wire and tighten it to secure the connection.

## Connections (continued)

### To connect the AM antenna

#### AM loop antenna (included)

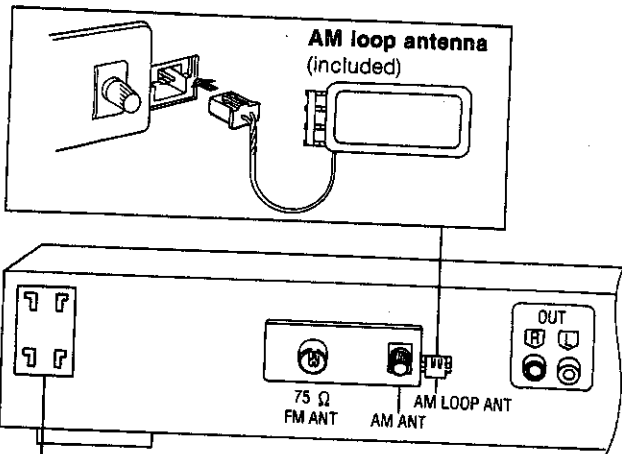

AM loop antenna location

Install the AM antenna holder (included) at the rear panel of this unit and then attach the AM loop antenna to the AM antenna holder (facing in the direction of best reception).

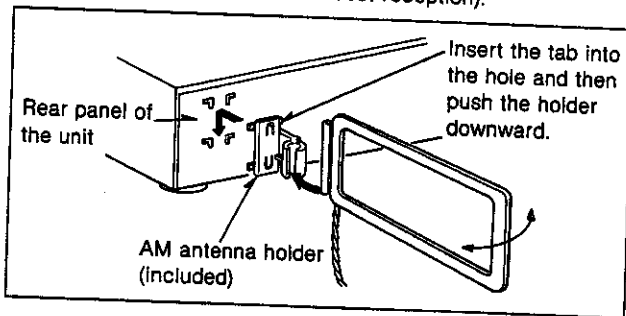

#### When mounting the antenna to a wall or a rack

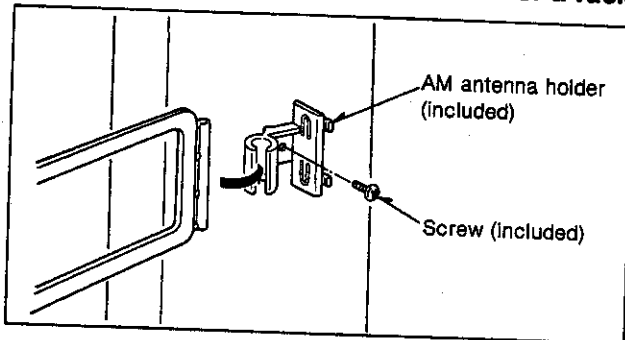

Pay attention to the following points when mounting the antenna.

- Do not mount it horizontally (Doing so will impair reception).
- Do not mount it close to power cords, speaker wires or metal surfaces (Doing so will result in noise).
- Do not mount it close to a tape deck. When the tape deck is being used, chirping or beeping sounds may result.

#### AM outdoor antenna (not included)

An outdoor antenna may be required in a mountainous region, or if this unit is located inside a reinforced-concrete building, etc.

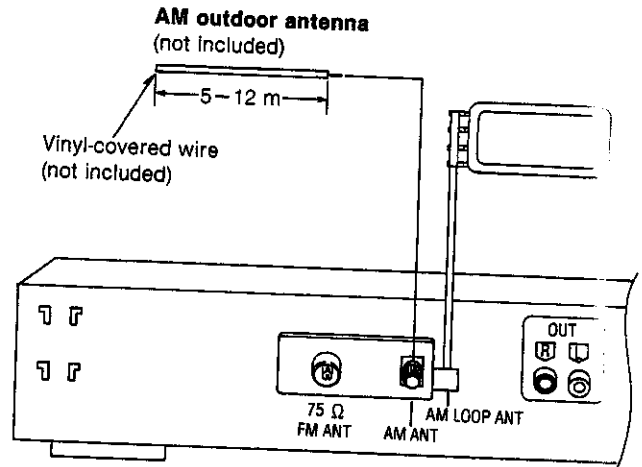

Use 5-12 m of vinyl-covered wire horizontally at the window or other convenient location.

#### Note

- Be sure to connect the AM loop antenna even when an outdoor antenna is used.
- When the unit is not in use, disconnect the outdoor antenna to prevent possible damage that may be caused by lightning. Never use an outdoor antenna during an electrical storm.

## Connection to the amplifier and of the power cord

(For areas except Australia and N.Z.)

### Before connection:



Be sure to set the voltage selector to "110 V-127 V" or "220 V-240 V" according to the area in which the unit will be used.

[Use a minus (-) screwdriver]

### Note

Note that this unit will be seriously damaged if this setting is not made correctly.

### Stereo connection cable

White (L)   
Red (R) 

Although the figure below shows the AC power supply cord being connected to a household AC outlet, if the amplifier is equipped with an AC outlet, connect the cord to that outlet.

(For areas except Australia and N.Z.)

If the power plug will not fit your socket, use the power plug adaptor (included).

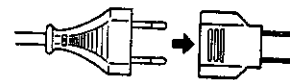

Amplifier

This unit

AC power supply cord (included)

Connect this cord after all other cables and cords are connected.

Stereo connection cable (included)

Household AC outlet

(For areas except Australia and N.Z.)

### Insertion of Connector

Even when the connector is perfectly inserted, depending on the type of inlet used, the front part of the connector may jut out as shown in the drawing. However there is no problem using the unit.

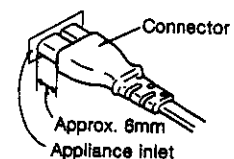

# Receiving radio broadcasts

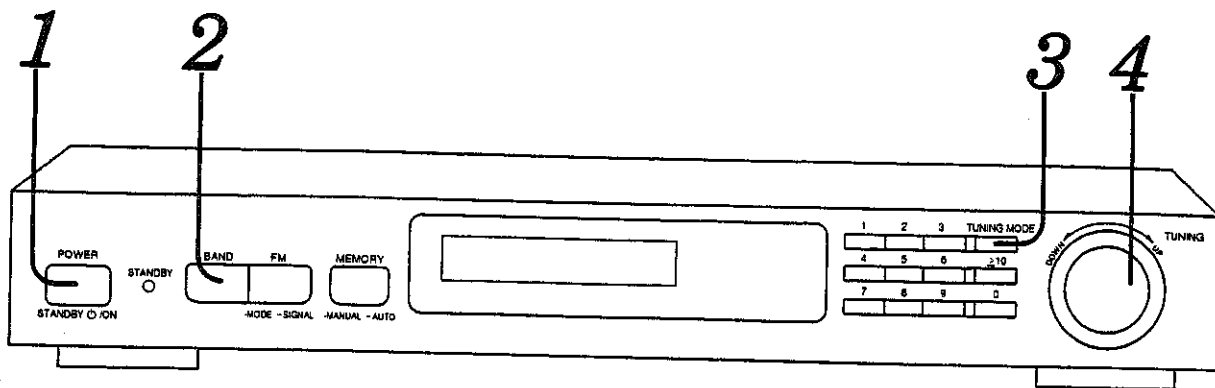

1

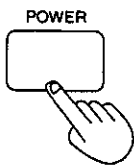

**Press POWER.**  
The unit will switch on.

2

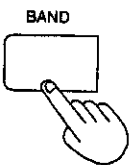

**Press BAND to select the desired band.**

The band indicator changes in the following way each time the button is pressed.

**FM ⇌ AM**

**To change the AM frequency step:**

The AM frequency step is set to 9 kHz before shipment. To change to 10 kHz per step, press and hold the band select button for 4 seconds while the "AM" of the band indicator is illuminated.

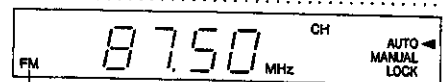

Band indicator

**FM:** for FM broadcasts  
**AM:** for AM broadcasts

3

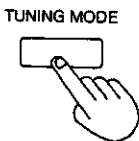

**Press TUNING MODE to select the desired tuning mode, "AUTO" or "MANUAL".**

Each time the button is pressed, the position of the tuning mode indicator ◀ mark will change as follows.

**AUTO → MANUAL → LOCK**

**AUTO:** To automatically tune to the desired frequency in step 4.  
**MANUAL:** To manually tune to the desired frequency in step 4.

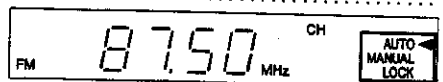

Tuning mode indicators

4

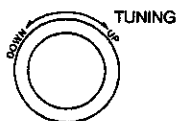

**Turn TUNING control so as to tune to the desired frequency.**

**DOWN:** To tune to a lower frequency.  
**UP:** To tune to a higher frequency.

**Automatic tuning** (when "AUTO" is selected in step 3)

The frequency will begin to change when the TUNING control is turned, and then automatically stop when a broadcast frequency with good reception is found.

**Manual tuning** (when "MANUAL" is selected in step 3)

The frequency will change only by the amount that the TUNING control is turned.



Illuminates when receiving an FM stereo broadcast

Illuminates when tuned precisely



## To lock a broadcast station being received

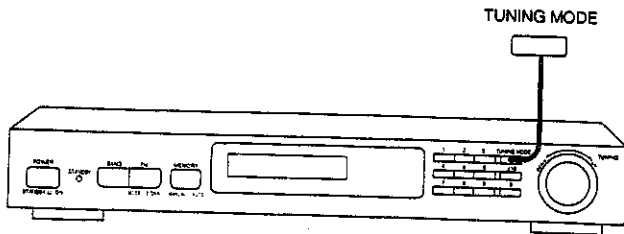

**TUNING MODE** Press TUNING MODE to select "LOCK".

(Refer to step 3 on page 8.)



During this mode, the frequency will not change if the TUNING control is turned.

## To check the FM signal strength

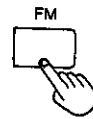
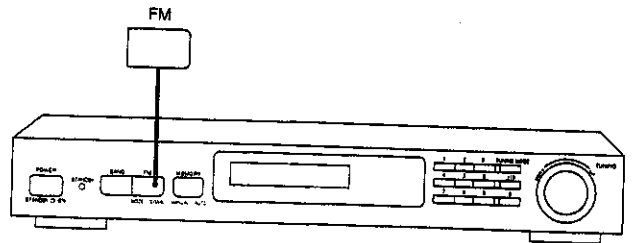

[While receiving an FM broadcast signal...]  
Press and hold FM until the display changes to show the FM signal strength.

The signal strength will be displayed in 2-dB increments.

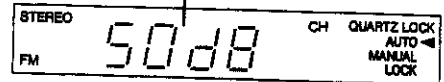

To return to the frequency display, press the button once again.

## If noise is excessive in the FM stereo mode

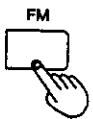
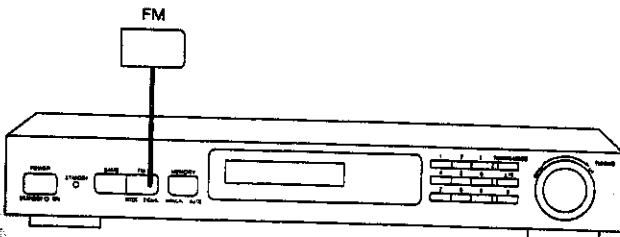

Press FM momentarily.

(The MONO indicator will illuminate and the mode will change to monaural.)

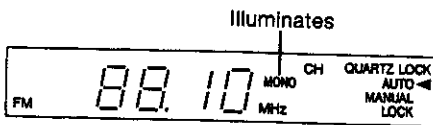

Although the stereo effect will be lost, the noise interference will be reduced, making it easier to listen to the broadcast signal.  
To cancel the monaural mode, press the button once again.

### For your reference:

- This unit is normally in the auto mode, and it automatically distinguishes between stereo and monaural broadcast signals.
- The mode will automatically change back to auto if the TUNING control is turned so that the frequency changes.

### For your reference:

The display will automatically change back to show the frequency if the TUNING control is turned so that the frequency changes.

# Preset tuning

By presetting the desired broadcast stations into the memory channels of this unit, broadcast stations can be selected simply by pressing preset tuning button(s). (Refer to page 11 for tuning.)

## Before presetting

### How many broadcast stations can be preset?

A total of 30 FM and AM stations can be preset.

### How is presetting done?

The two following methods are available.

#### • Automatic memory presetting

Automatic memory presetting allows this unit to automatically search for broadcast stations and then preset them into memory.

With this function, searching proceeds from the frequency currently being displayed and continues to highest frequency, and broadcast stations are preset in the order in which they are located.

In this method, the channel ranges that can be preset into the memory for different bands (FM or AM) are set as follows.

Channel

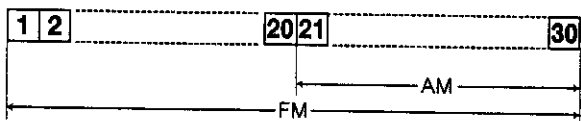

For example, after presetting the FM band, if the AM band is preset, the previous presettings in the sections in the above illustration which overlap will be erased and the subsequent settings will be preset. Therefore, the FM band stations will be kept for channels 1–20 and the AM band stations will be preset to channels 21–30.

#### • Manual memory presetting

The desired broadcast stations can be preset into the desired channels by the user.

This can also be used as a method for changing selected broadcast stations that were preset in "Automatic memory presetting".

### Please remember this:

If a new broadcast station is preset into a channel, the setting for the broadcast station which was previously entered in that channel will be automatically erased.

## Automatic memory presetting

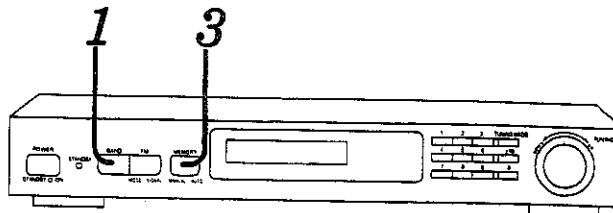

1

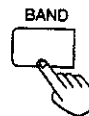

Press **BAND** to select "FM" or "AM".

2

Set to the frequency from which you want to start automatic memory presetting. (Follow steps 3 and 4 on page 8.)

3



Press and hold **MEMORY** until the frequency begins to change.

(Automatic memory presetting will start.)

To stop press **MEMORY** once again.

### When a broadcast station is preset

The preset frequency and the preset channel number will be displayed for approximately 1 second.



### When presetting is completed

The last broadcast station to be preset will be displayed.

#### Note

Correct presetting may not be possible in cases where the broadcast waves are too strong or too weak. In such cases, carry out presetting manually.

## Manual memory presetting

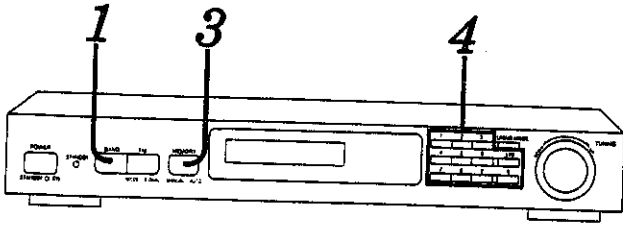

**1** Press **BAND** to select "FM" or "AM".

**2** Set to the desired broadcast.  
(Follow steps 3 and 4 on page 8.)

You can also set the stereo mode to the monaural position. (Refer to page 9.)

**3** Press **MEMORY** momentarily.



To cancel the memory function, press **MEMORY** again.

**4** Specify the desired channel to be preset using the numeric button(s) (complete presetting).

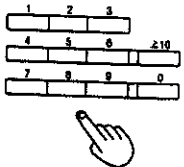

**To designate channels 1-9:**  
Press the appropriate (1-9) preset-tuning button.

**To designate channels 10-30:**  
(Example: Channel 20)

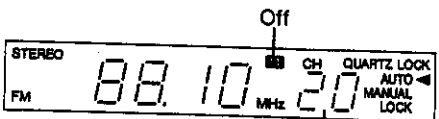
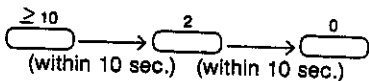

Preset channel

**To continue presetting**  
Repeat steps 1 through 4.

## To listen to preset broadcast stations

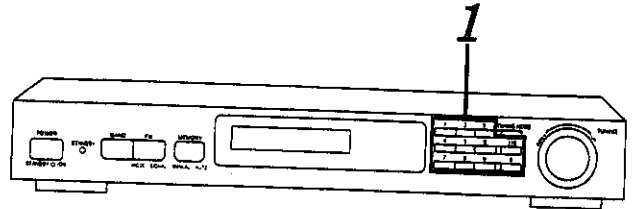

**1** Specify the preset channel using the numeric button(s).  
**To designate channels 1-9:**  
Press the appropriate (1-9) preset-tuning button.

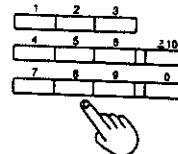

**To designate channels 10-30:**  
(Example: Channel 20)

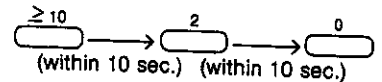

# Troubleshooting guide

Before requesting service for this unit, check the chart below for a possible cause of the problem you are experiencing. Some simple checks or a minor adjustment on your part may eliminate the problem and restore proper operation.

If you are in doubt about some of the check points, or if the remedies indicated in the chart do not solve the problem, refer to the directory of Authorized Service Centers (enclosed with this unit) to locate a convenient service center, or consult your Technics dealer for instructions.

Problem	Probable cause(s)	Suggested remedy
<b>While listening to FM broadcasts</b>		
An unusual hissing noise is heard when listening to the broadcast in stereo, but is not heard when listening monaurally.	A slight noise may be heard because the method used for modulation of FM stereo broadcasts is different than that used for monaural broadcasts.	<ul style="list-style-type: none"> <li>• Try reducing the treble sound by using the treble control of the amplifier.</li> <li>• Set the FM mode select button to the monaural position. (Note that the broadcast will then be heard as monaural sound.)</li> </ul>
Noise is excessive in both stereo and monaural broadcasts.	Poor location and/or direction of the antenna. Transmitting station is too far away.	<ul style="list-style-type: none"> <li>• Try changing the location, height and/or direction of the antenna.</li> <li>• If an indoor antenna is being used, change to an outdoor antenna.</li> <li>• Try using an antenna with more elements.</li> </ul>
The FM stereo indicator or the quartz lock indicator flickers, without completely illuminating.	Poor location and/or direction of the antenna. Transmitting station is too far away.	<ul style="list-style-type: none"> <li>• Try changing the location, height and/or direction of the antenna.</li> <li>• If an indoor antenna is being used, change to an outdoor antenna.</li> <li>• Try using an antenna with more elements.</li> </ul>
Excessive distortion in the sound of stereo broadcasts.	Nearby building or mountain. [Multipath distortion is being caused by the mutual interference of broadcast signals received directly from the transmitting station (direct waves) and signals being reflected from nearby buildings or mountains (reflected waves).]	<ul style="list-style-type: none"> <li>• Try using an antenna with more elements.</li> </ul>
Sound is distorted, "popping" noise is heard, and/or the volume level becomes low.	Broadcast signals are being disturbed by nearby automobile traffic or airplanes.	<ul style="list-style-type: none"> <li>• Relocate the antenna and the connection wires to a place farther away from where automobiles pass.</li> </ul>

<b>While listening to AM broadcasts</b>		
An unusual "beat" sound is heard.	Unit is being used at the same time as the television set.	<ul style="list-style-type: none"> <li>• Turn off the television set, or use this unit farther away from it.</li> </ul>
	Interference from adjacent broadcast signal.	<ul style="list-style-type: none"> <li>• Try reducing the treble sound by using the treble control of the amplifier.</li> </ul>
A low-pitched "hum" sound is heard when the broadcast is tuned.	The AM loop antenna connection wires are too close to the power cord.	<ul style="list-style-type: none"> <li>• Place the antenna connection wires and the power cord farther apart.</li> </ul>
	The power supply frequency from the power cord is modulated and heard from the speakers.	<ul style="list-style-type: none"> <li>• Install a special outdoor antenna.</li> </ul>
A strange hissing noise is produced continuously or intermittently.	Caused by the "discharge phenomenon" and the "oscillation phenomenon" of electric appliances (such as fluorescent lights, TV, small series-type motors, rectification equipment, etc.).	<ul style="list-style-type: none"> <li>• Try placing this unit farther away from such equipment.</li> <li>• Install noise-prevention equipment on this unit or on the electric appliance.</li> </ul>

**Matsushita Electric Industrial Co., Ltd.**  
Central P.O. Box 288, Osaka 530-91, Japan

## Free Manuals Download Website

<http://myh66.com>

<http://usermanuals.us>

<http://www.somanuals.com>

<http://www.4manuals.cc>

<http://www.manual-lib.com>

<http://www.404manual.com>

<http://www.luxmanual.com>

<http://aubethermostatmanual.com>

Golf course search by state

<http://golfingnear.com>

Email search by domain

<http://emailbydomain.com>

Auto manuals search

<http://auto.somanuals.com>

TV manuals search

<http://tv.somanuals.com>