

Technics®

How to use the remote control transmitter RAK-SA607MH



This remote control transmitter can be used to operate other units manufactured by this company in addition to the system components you have purchased, including TVs, VCRs and laser disc players.

It is also possible to change-over the remote control code so that the remote control transmitter can operate TVs, VCRs and laser disc players which have not been manufactured by this company.

Note

Depending on the model, there may be cases where operation is not possible.

For an explanation on how to set up your remote control and precautions, see "Concerning the remote control" in the Operating Instructions.

Preparations before use

1. Check the appropriate connection of the power cords and connection cables in order to operate the system components correctly.
2. Turn on the power of each unit and speaker systems to be used.

Basic operations

	<p>To turn the power supply ON/OFF</p>	<p>AUDIO/TUNER → POWER</p> <p>Once the power has been set to ON, it can be turned ON and OFF simply by pressing POWER.</p> <p>Note After turning the power of the TV, VCR or laser disc player ON or OFF, always press AUDIO/TUNER before pressing POWER when turning the power of the system components ON and OFF.</p>
	<p>To select an input source</p>	<p>TV/VCR 2 VCR 1 AUDIO/TUNER CD TAPE MONITOR</p> <p>Note PHONO can not be selected with this remote control.</p>
	<p>To turn on the Dolby Pro Logic and select the desired mode</p>	<p>DOLBY PRO LOGIC</p> <p>Changes as follows each time the button is pressed. SURROUND ↔ 3 STEREO</p>
	<p>To turn on the SFC function and select the desired mode</p>	<p>SFC</p> <p>Changes as follows each time the button is pressed. LIVE → THEATER → SIMULATED</p>
	<p>To output a test signal</p>	<p>When the SURROUND or 3 STEREO mode is ON</p> <p>TEST</p> <p>Press once more to stop a test signal.</p>
	<p>To adjust the output level of the center speaker</p>	<p>When the SURROUND, 3 STEREO or THEATER mode is ON</p> <p>- CENTER +</p>
	<p>To adjust the output level of the surround speakers</p>	<p>When the SURROUND or SFC mode is ON</p> <p>- SURROUND +</p>
	<p>To turn the Dolby Pro Logic/SFC OFF and ON</p>	<p>OFF/ON</p>
	<p>To mute the sound level</p>	<p>MUTING</p> <p>The message "MUTING ON NOW" runs repeatedly from right to left across the display as long as the muting function is on. Press once more to return to the original volume.</p>
<p>To adjust the volume level</p>	<p>- VOLUME +</p>	

To listen to radio broadcasts

	To switch the remote control transmitter to tuner operation mode	<input type="checkbox"/> AUDIO/TUNER The input source for the amplifier will switch to the tuner, and operation of the buttons listed below will be possible.											
	To select the desired channel sequentially	<input type="checkbox"/> CH ^ <input type="checkbox"/> CH v Select the desired preset channel.											
	To select the desired channel directly	<table style="display: inline-table; border: none;"> <tr> <td>1</td><td>2</td><td>3</td><td></td> </tr> <tr> <td>4</td><td>5</td><td>6</td><td>>10/ENTER</td> </tr> <tr> <td>7</td><td>8</td><td>9</td><td>0</td> </tr> </table> (Example: Channel 9) <input type="checkbox"/> 9 (Example: Channel 12) <input type="checkbox"/> >10/ENTER → <input type="checkbox"/> 1 → <input type="checkbox"/> 2	1	2	3		4	5	6	>10/ENTER	7	8	9
1	2	3											
4	5	6	>10/ENTER										
7	8	9	0										

To listen to tapes

	To switch the remote control transmitter to cassette deck operation mode	<input type="checkbox"/> TAPE MONITOR The input source for the amplifier will switch to the tape deck, and operation of the buttons listed below will be possible.
	To select the tape deck (DECK 1/DECK 2)	<input type="checkbox"/> DECK 1/2
	To start play	<input type="checkbox"/> ← <input type="checkbox"/> → (Reverse) (Forward) Playback will begin.
	To fast-forward or rewind the tape	While the tape is stopped <input type="checkbox"/> ←← <input type="checkbox"/> →→
	To stop playback temporarily	<input type="checkbox"/> Press once again to resume playback.
	To stop play	<input type="checkbox"/> ■

To listen to compact discs

	<p>To switch the remote control transmitter to CD operation mode</p>	<p>CD</p> <p>The input source for the amplifier will switch to the CD changer and operation of the buttons listed below will be possible.</p>
	<p>To start play</p>	<p></p>
	<p>To start play from the desired disc</p>	<p></p> <p>Select the disc number. If you select "0", the changer will switch to the single disc play mode. (When selecting discs, the >10/ENTER button does not respond to touch.)</p> <p>For your reference</p> <p>DISC ENTER</p> <p>If you press this button instead of the ► button shown in the above procedure, the CD changer will stop and display the disc number. To start the disc, press ►.</p>
	<p>To start play from the desired track</p>	<p>Select the track number. (Example: Track 9)</p> <p></p> <p>(Example: Track 12)</p> <p></p>
	<p>To skip a track</p>	<p>CD/VDP</p> <p></p>
	<p>To stop play temporarily</p>	<p></p> <p>Press ► to resume play.</p>
	<p>To stop play</p>	<p></p>

To watch TV broadcasts

The explanations below are examples of operation in the case where a TV and VCR have been connected according to the method given on page 7 of the operating instructions for the system components.

For detailed information concerning TV or VCR operation, please read the operating instructions for each unit carefully.

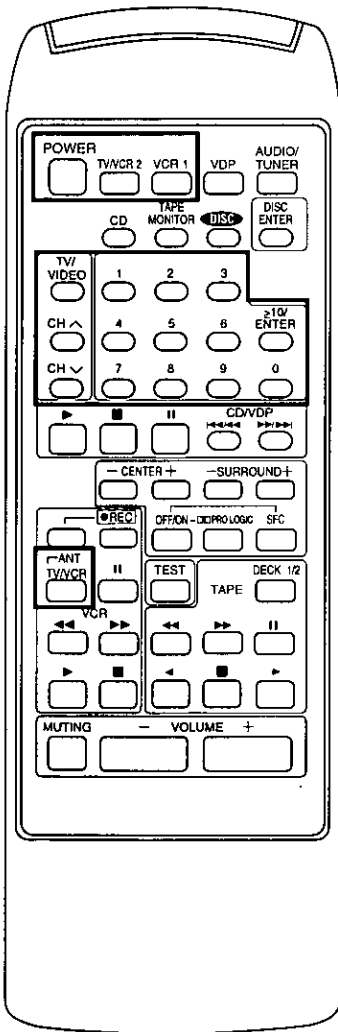

To watch TV broadcasts with just a TV

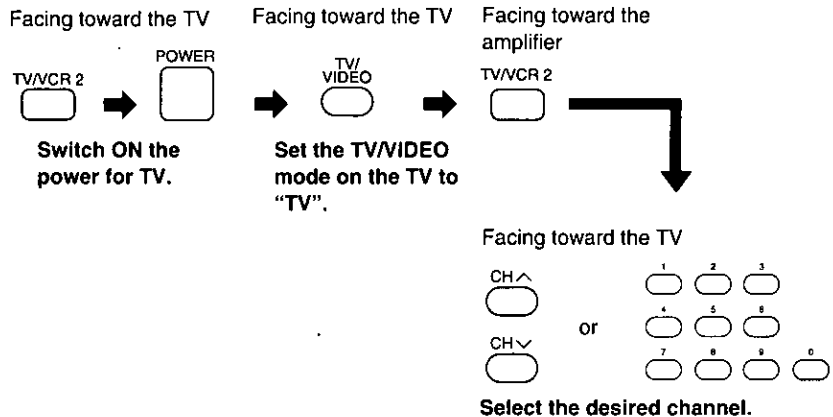

To watch TV broadcasts with a VCR tuner

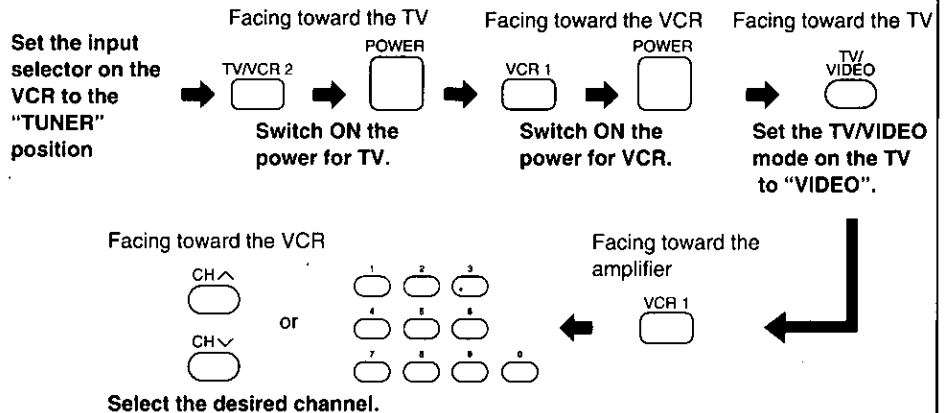

To switch OFF the power for TV

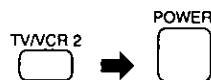

To switch OFF the power for VCR



How to use the antenna input selection button

Each time the button is pressed, the antenna input at the VCR changes from "TV" to "VCR" and vice versa.



This button is used when using ENTER to select a channel on a TV or VCR which has not been manufactured by this company.

To watch video tapes/To record video/audio sources on the VCR

The explanations below are examples of operation in the case where a TV and VCR have been connected according to the method given on page 7 of the operating instructions for the system components.

For detailed information concerning TV or VCR operation, please read the operating instructions for each unit carefully.

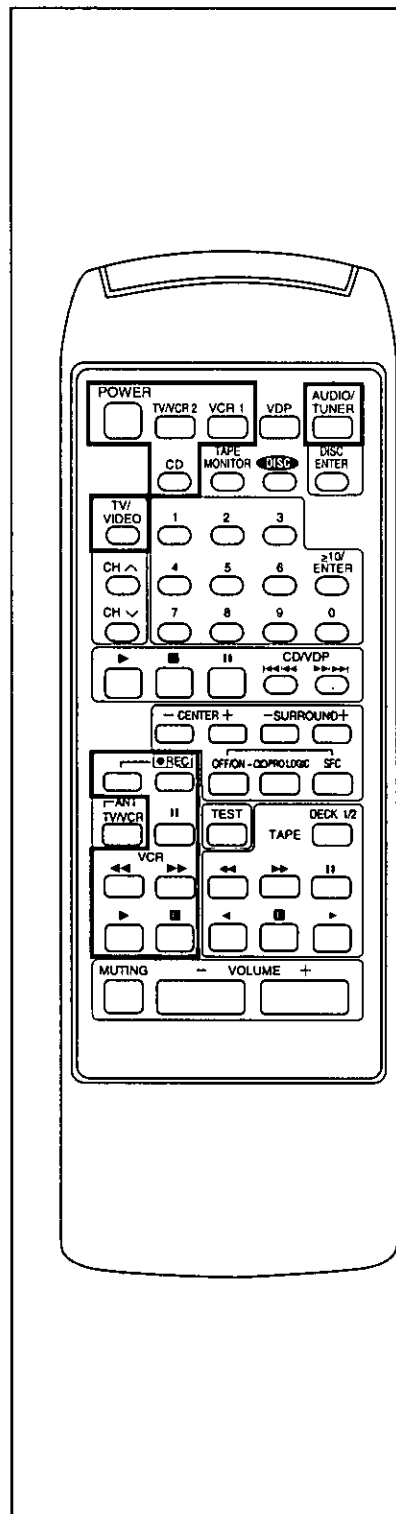

To watch video tapes

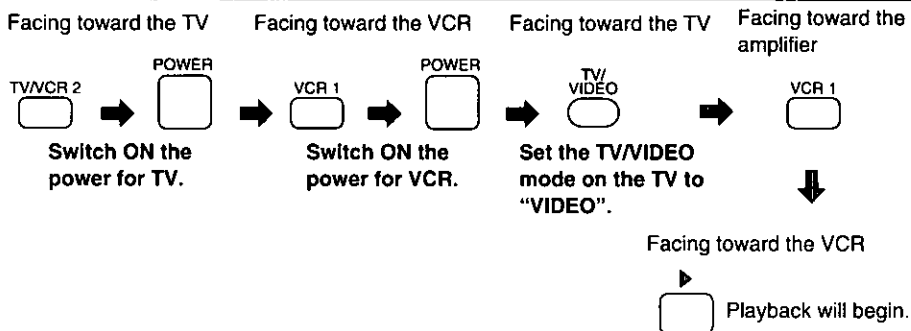

To fast-forward or rewind the video tape

In the stop mode



To stop playback temporarily



Press once again to resume playback.

To stop playback



To record video/audio sources on the VCR

Select the input source to be recorded

Start the selected source.

Facing toward the VCR

Note

Recording from the tape deck is not possible.

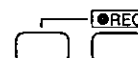

Press these buttons simultaneously.
(Recording will begin.)



To stop recording temporarily



Press once again to resume recording.

To stop recording



To switch OFF the power for TV

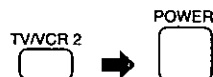

To switch OFF the power for VCR



To operate laser disc players

The explanations below are examples of operation in the case where a TV and laser disc player have been connected according to the method given on page 7 of the operating instructions for the system components.

For detailed information concerning TV or laser disc player operation, please read the operating instructions for each unit carefully.

To watch a laser disc

Facing toward the TV TV/VCR 2 → POWER Switch ON the power for TV.	Facing toward the laser disc player VDP → POWER Switch ON the power for laser disc player.	Facing toward the TV TV/VIDEO Set the TV/VIDEO mode on the TV to "VIDEO".	Facing toward the amplifier TV/VCR 2 Playback will begin.
--	---	--	---

To search for the desired position	In the play mode VDP → CD/VDP
To stop playback temporarily	VDP → [Pause] Press ▶ to resume play.
To stop playback	VDP → [Stop]

To switch OFF the power for TV

TV/VCR 2 → POWER

To switch OFF the power for laser disc player

VDP → POWER

Changing the remote control code

Change the remote control code in either of the following circumstances:

- If the Panasonic TV or VCR does not operate as a result of a difference in the remote control code.
- If you wish to operate some other make of TV, VCR or laser disc player.
(Refer to pages 5–7 for the buttons which can be operated.)

How to change the remote control code

1 (TV) (VCR)
TV/VCR 2 VCR 1
(Laser disc player)
VDP

While holding down the button corresponding to the component you wish to operate...

2

1 2 3
 4 5 6
 7 8 9 0

Aim the remote control at the component you wish to operate and press the numeric buttons to enter the appropriate two-digit code number. (Refer to the table below for the code number.)

When the two-digit code number is entered, the remote control will automatically output the power on/off signal. If the remote control has been correctly changed to the code for the component to be operated, the power of the component will be switched on or off.

Note
If there is more than one code number indicated in the code table, repeat the above procedure until you find a code number for which the power of the component is switched on or off.

TV				VCR				Laser disc player	
Manufacturer	Code No.	Manufacturer	Code No.	Manufacturer	Code No.	Manufacturer	Code No.	Manufacturer	Code No.
Panasonic	01,02,09	Sylvania	07,11,15	Panasonic	01,02	Sanyo	18	Panasonic	01
Sony	04	Symphonic	17,23	Sony	05,06,07	Sharp	16,17	Sony	02
G-E	03,09,13	Toshiba	10	Fisher	13,14,15,18	Shintom	32	Pioneer	03
Gold Star	06,07,15,20,22	Zenith	18	Funai	30	Symphonic	30		
Hitachi	05,06,07			G-E	08,11	Toshiba	23,24		
JVC	12			Gold Star	27	Zenith	20		
LXI	07,11,13,14,15			Hitachi	10,11				
Magnavox	06,07,11,15			JVC	19				
Mitsubishi	07,15,16			LXI	10,13,15,18,27				
NEC	07,15			Magnavox	08,09,12				
Philco	06,07,11			Mitsubishi	21,22,28,29				
Philips	11			NEC	19,25,31				
Pioneer	19			Philco	08,09				
Quasar	01,02,09			Philips	08,09,12				
RCA	03,07,13			Quasar	01,02,08,09				
Sanyo	14			RCA	03,04,08,09,10				
Sharp	06,08,21				11,12,23,24,26				

Note Depending on the model, there may be cases where operation is still not possible even if the remote control code is switched over.

Note If the remote control code is changed in accordance with the method given above, the code will be re-initialized to the Panasonic code (code 01) when the batteries are replaced. To change the code back again, repeat the operations given above.

Free Manuals Download Website

<http://myh66.com>

<http://usermanuals.us>

<http://www.somanuals.com>

<http://www.4manuals.cc>

<http://www.manual-lib.com>

<http://www.404manual.com>

<http://www.luxmanual.com>

<http://aubethermostatmanual.com>

Golf course search by state

<http://golfingnear.com>

Email search by domain

<http://emailbydomain.com>

Auto manuals search

<http://auto.somanuals.com>

TV manuals search

<http://tv.somanuals.com>