

Technics

Electronic Components

SD-A840 SD-D740
SD-A850 SD-D750
SD-A860 SD-D760
SD-A870 SD-D770



T4P is the standard mark for the "P-mount" plug-inconnector system. Products carrying this mark are interchangeable and compatible with each other.

OPERATING INSTRUCTIONS



The photographs show system SD-A850.

Before operating this unit, carefully read these operating instructions and the enclosed operating instructions of the remote-control transmitter.

To Our Valued Customers,

Technics, The Science of Sound, welcomes the challenge of new audio technologies and brings you a multitude of world-renowned, high quality audio components, all backed by our time-honored commitment to innovation, value, and quality. Technics captures the power of new ideas and turns them into high performance components like digital compact disc players that feature High Speed Linear Motor Transports, high speed editing cassette decks, professional and consumer

turntables, Computer Drive New Class A amplifiers, and A/V receivers that intergrate both audio and video equipment.

The Technics list of advanced audio components continues. From Class AA amplifiers, honeycomb disc speakers, and multi-disc CD changers to the world's first touch-sensitive graphic equalizer, Technics is a shining example of audio technology at its best.

These operating instructions are applicable to the following system.

For systems with graphic equalizer, please read the individual operating instructions included with graphic equalizer carefully.

System	Turntable	Tuner	Amplifier	Cassette deck
SD-A840/SD-A850/SD-A860/SD-A870	SL-BD27U	ST-S98	SU-V98	RS-T19
SD-D740/SD-D750/SD-D760/SD-D770	SL-B280U	ST-Z980	SU-Z980	RS-D190W

Contents

• Suggestions for Safety	3	• Listening to Radio Broadcasts	15
• Accessories	4	• Listening to Tapes	16
• Turntable Assembly	4	• Recording	18
• Connections	5	• Timer Recording/Playback	20
• Antenna Connections	8	• Adjustment	21
• Front Panel Controls and Functions	9	• Maintenance	21
• Standard Operating Procedures	12	• Troubleshooting Guide	22
• Listening to Phono Discs	13	• Product Service	23
• Memory Presettings	14	• Technical Specifications	Back cover

The model number and serial number of this product can be found on either the back or the bottom of the unit. Please note them in the space provided below and retain this booklet as a permanent record of your purchase to aid identification in the event of theft.

	MODEL NUMBER	SERIAL NUMBER
Turntable :	_____	_____
Tuner :	_____	_____
Amplifier :	_____	_____
Cassette deck :	_____	_____

CAUTION

This equipment has been tested and found to comply with the limits for a Class B computing device in accordance with the specifications set forth in Subpart J of Part 15 of the FCC Rules. If this equipment causes interference to radio or television reception, which can be determined by turning the equipment on and off, use the equipment in another location and/or utilize an electrical outlet different from that used by the receiver.

WARNING:

TO REDUCE THE RISK OF FIRE OR ELECTRIC SHOCK, DO NOT EXPOSE THIS APPLIANCE TO RAIN OR MOISTURE.



CAUTION
RISK OF ELECTRIC SHOCK
DO NOT OPEN



CAUTION: TO REDUCE THE RISK OF ELECTRIC SHOCK, DO NOT REMOVE SCREWS. NO USER-SERVICEABLE PARTS INSIDE. REFER SERVICING TO QUALIFIED SERVICE PERSONNEL.



The lightning flash with arrowhead symbol, within an equilateral triangle, is intended to alert the user to the presence of uninsulated "dangerous voltage" within the product's enclosure that may be of sufficient magnitude to constitute a risk of electric shock to persons.



The exclamation point within an equilateral triangle is intended to alert the user to the presence of important operating and maintenance (servicing) instructions in the literature accompanying the appliance.

Suggestions for Safety

Before using this unit, be sure to read applicable items of the operating instructions and these safety suggestions carefully. Afterwards keep them handy for future reference. Take special care to follow the warnings indicated on the unit itself as well as in the operating instructions.

- 1. Water and Moisture** -- The unit should not be used near water -- for example, near a bathtub, washbowl, kitchen sink, laundry tub, in a wet basement, or near a swimming pool, and the like.
- 2. Object and Liquid Entry** -- Care should be taken so that objects do not fall and liquids are not spilled into the enclosure through openings.
- 3. Ventilation** -- The unit should be situated so that its location or position does not interfere with its proper ventilation. For example, the unit should not be situated on a bed, sofa, rug, or similar surface that may block the ventilation openings; or placed in a built-in installation, such as a bookcase or cabinet that may impede the flow of air through the ventilation openings.
- 4. Heat** -- The unit should be situated away from heat sources such as radiators, heat registers, stoves, or other units that produce heat.
- 5. Power Sources** -- The unit should be connected to a power supply only of the type described in the operating instructions or as marked on the unit.
- 6. Power Cord Protection** -- AC power supply cords should be routed so that they are not likely to be walked on or pinched by items placed upon or against them, paying particular attention to cords at plugs, convenience receptacles, and the point where they exit from the unit. Never take hold of the plug or cord if your hand is wet, and always grasp the plug body when connecting or disconnecting it.
- 7. Polarization** -- If the unit is equipped with a polarized AC power plug (a plug having one blade wider than the other), that plug will fit into the AC outlet only one way. This is a safety feature. If you are unable to insert the plug fully into the outlet, try reversing the plug. If the plug should still fail to fit, contact your electrician to replace your obsolete outlet. Do not defeat the safety purpose of the polarized plug.
- 8. Carts and Stands** -- The unit should be used only with a cart or stand that is recommended by the manufacturer.
- 9. Wall or Ceiling Mounting** -- The unit should be mounted to a wall or ceiling only as recommended by the manufacturer.
- 10. Cleaning** -- The unit should be cleaned only as recommended by the manufacturer.

- 11. Outdoor Antenna Grounding** -- If an outside antenna is connected to the receiver, be sure the antenna system is grounded so as to provide some protection against voltage surges and built-up static charges. Section 810 of the National Electrical Code, ANSI/NFPA No. 70 - 1984, provides information with respect to proper grounding of the mast and supporting structure, grounding of the lead-in wire to an antenna discharge unit, size of grounding conductors, location of antenna-discharge unit, connection to grounding electrodes, and requirements for the grounding electrode. See figure below.

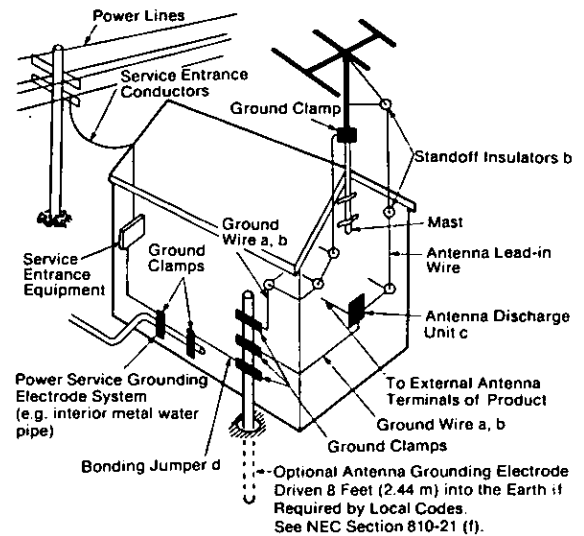

- Use No. 10 AWG (5.3 mm²) copper, No. 8 AWG (8.4 mm²) aluminum, No. 17 AWG (1.0 mm²) copper-clad steel or bronze wire, or larger, as a ground wire.
 - Secure antenna lead-in and ground wires to house with stand-off insulators spaced from 4 feet (1.22 m) to 6 feet (1.83 m) apart.
 - Mount antenna discharge unit as close as possible to where lead-in enters house.
 - Use jumper wire not smaller than No. 6 AWG (13.3 mm²) copper, or the equivalent, when a separate antenna-grounding electrode is used. See NEC Section 810-21 (j).
- 12. Power Lines** -- An outdoor antenna should be located away from power lines.
 - 13. Nonuse Periods** -- The AC power supply cord of the unit should be unplugged from the household AC outlet when left unused for a long period of time.
 - 14. Damage Requiring Service** -- The unit should be serviced by qualified service personnel when:
 - The AC power supply cord or the plug has been damaged; or
 - Objects have fallen or liquid has been spilled into the unit; or
 - The unit has been exposed to rain; or
 - The unit does not appear to operate normally or exhibits a marked change in performance; or
 - The unit has been dropped, or the enclosure damaged.
 - 15. Servicing** -- The user should not attempt to service the unit beyond that described in the operating instructions. All other servicing should be referred to qualified service personnel.

Accessories

All accessories except those for the turntable, the remote-control transmitter and batteries are packed with the cassette deck.

Quartz Synthesizer AM/FM Stereo Tuner

- AC power supply cord (polarized) 1

Thin type (SPT-1)

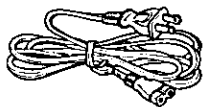

- FM indoor antenna 1



- Stereo connection cable (short) 1

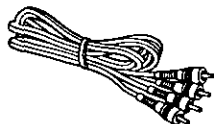

- AM loop antenna 1

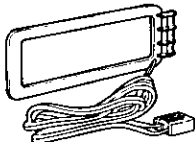

- AM antenna holders (A) 2
- AM antenna holders (B) 2

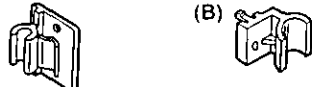

- Screws 2



Stereo Integrated Amplifier

- AC power supply cord (polarized) 1

Thick type (SPT-2)

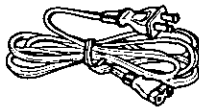

- Flat cable for remote-control (SWKUV98KM1) 1



- Connection cable for remote-control (SJP2257T) 1



- Remote-control transmitter (Configuration differs according to system.) 1

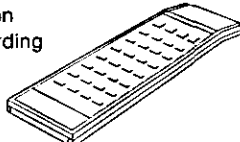

- Batteries 2

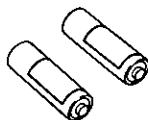

Stereo Double Cassette Deck

- AC power supply cord (non-polarized) 1

Thin type (SPT-1)

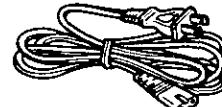

- Stereo connection cables (short) 2

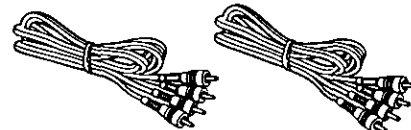

DC Servo Automatic Turntable System

- AC power supply cord (non-polarized) 1

Thin type (SPT-1)



- Stereo connection cable (long) 1



- Platter mat...1
- 45-rpm adaptor .. 1



Turntable Assembly

1. Remove turntable spacers and protective material (A), (B) and (C).

(Store them for future packing.)

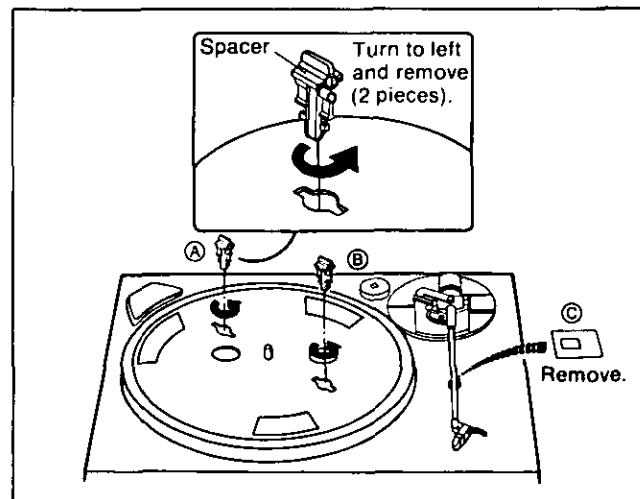

2. Attach the drive belt properly.

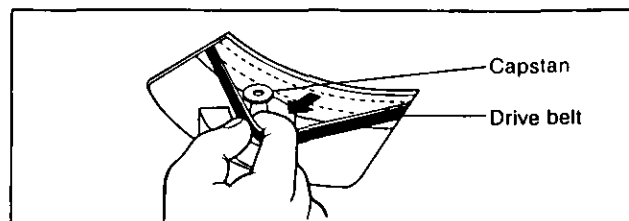

3. Place the platter mat on the platter, and turn the platter about ten times clockwise.

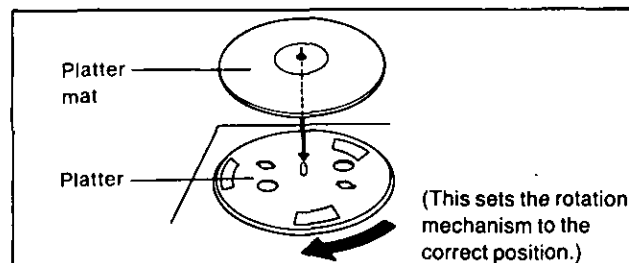

Connections

1 Placement of each unit

System with compact disc player

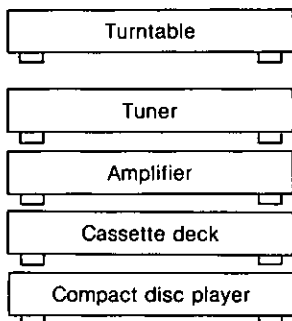

System with compact disc player and/or graphic equalizer

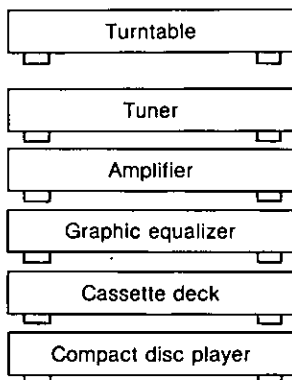

System with compact disc player, graphic equalizer and AV surround processor

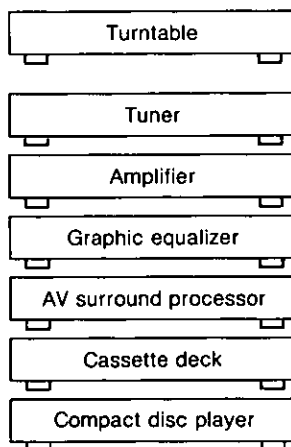

To place the tuner on the amplifier

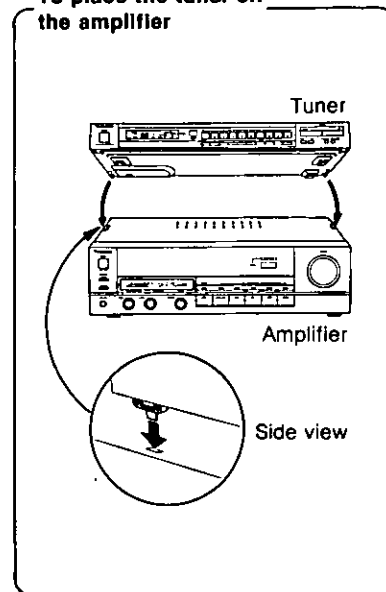

2 Connect the speaker systems.

Installation

The sound reproduced by a speaker is easily influenced by such factors as room acoustics and the system's location in the room. Before finally deciding where the speakers are to be placed, please read the following information carefully.

- The bass sound will be increased if the speakers are placed on the floor or close to a wall due to the reflection of sound. It is therefore possible to adjust the bass sound to some extent by adjusting the speaker's distance from the wall and/or floor.
- Undesirable resonance or sound reflection will occur if the speakers face a hard wall or window. Curtains or similar materials can be used to prevent these reflections.
- To prevent possible acoustic feedback the speaker system should be kept away from the turntable. This feedback (howling) can result from vibrations from the speakers. The turntable should, therefore, never be placed on the same surface as the speaker system. A thick piece of felt or similar material can be used under the turntable to reduce this problem.
- Even if the amplifier to be used has an output power rating lower than that of the speaker system, the amplifier output may become distorted. This "clipping" distortion creates an excessive input level which can damage the speaker system. This type of distortion also occurs, if the input signal to the amplifier is too large (For example, when excessive equalization is used).
- Keep this unit away from sources of heat, high humidity and direct sunlight.
- The speaker system should not be placed near a TV. The speaker magnet may cause disturbance to the TV picture.

Connections

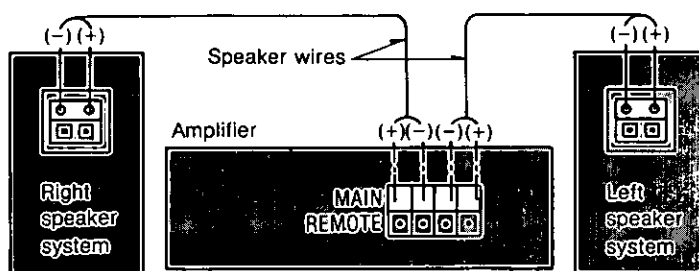

- ① Twist the core of the speaker wires.
- ② Lift up the lever, and insert the core until it can no longer be seen.
- ③ Press down the lever, and pull the cord gently to be sure that it is secure.

① 10 mm (13/32")
↓
Twist

Notes:

1. To prevent damage to circuitry, never short-circuit plus (+) and minus (-) speaker terminals.
2. Be sure to only connect positive (+) cords to positive (+) terminals, and negative (-) cords to negative (-) terminals.
3. Connections of speaker wires should be made before connecting the AC power supply cords.

■ For SD-A870 and SD-D770

Connect the surround speaker systems to the "SURROUND SPEAKERS" terminals of the AV surround processor.

■ "REMOTE" terminals

For connection to an additional pair of speakers.

■ Load impedance

The load impedance of any speaker used with this system must be 8-16 ohms.

3 Connect each component.

(Refer to pages 6 ~ 7.)

Connections (continued)

The followings are the included cords and cables, etc. Please make a connection correctly referring to the indicated number below.

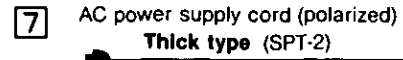
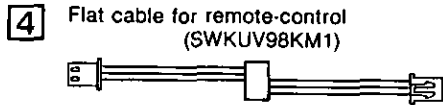
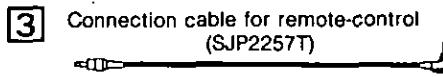
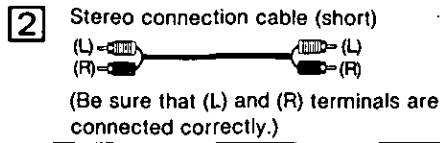
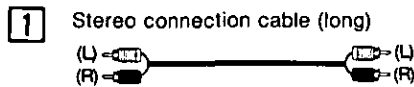

System with compact disc player

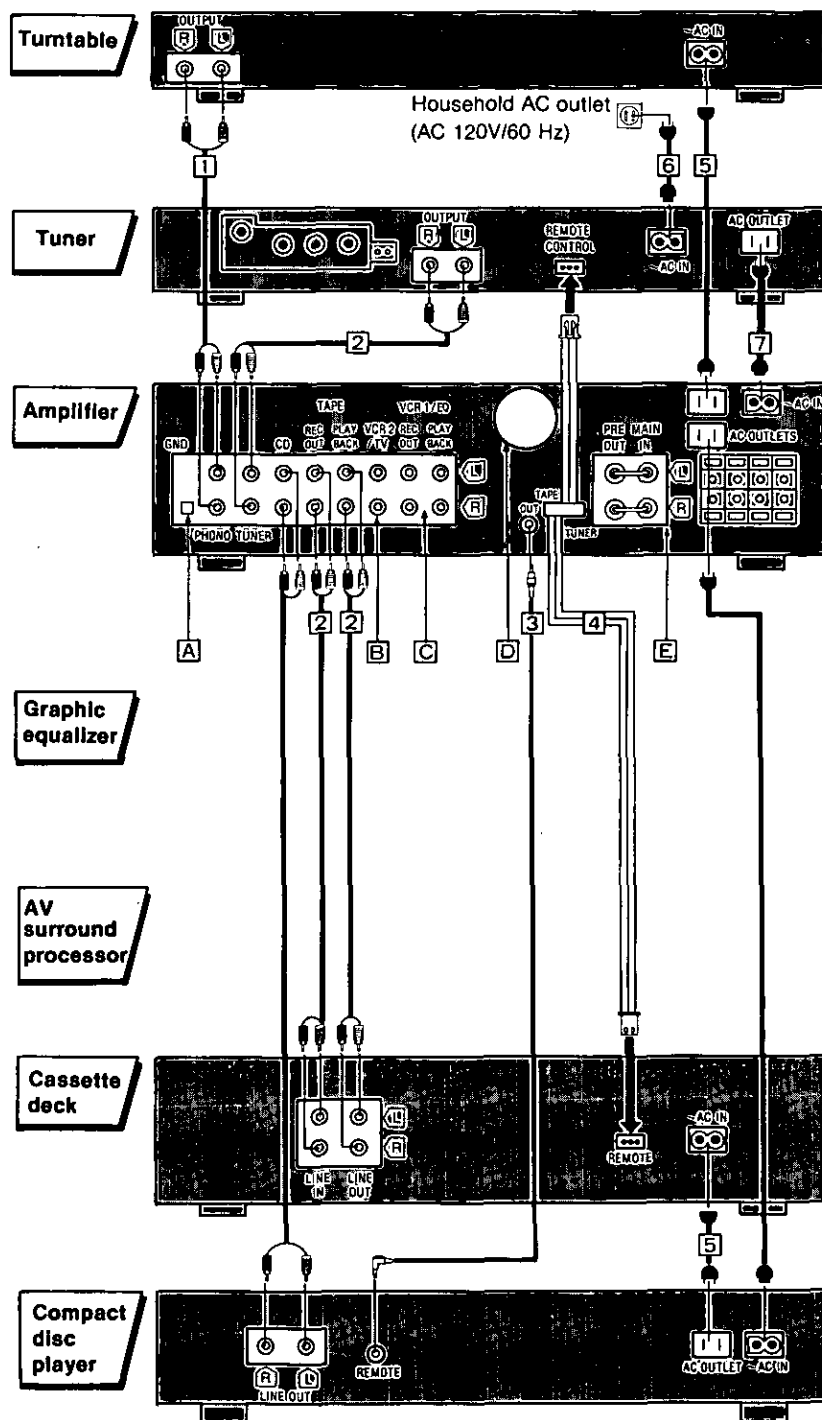

System with compact disc player and graphic equalizer

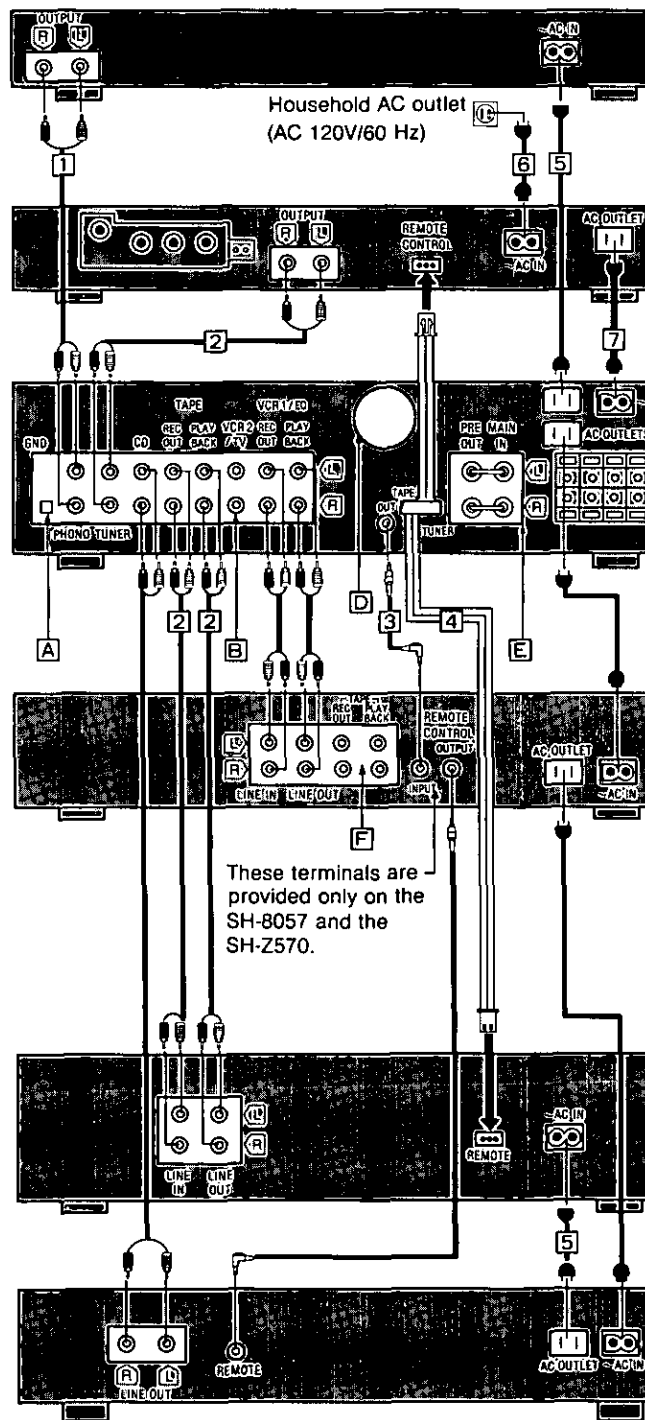

AC outlets

■ "UNSWITCHED" outlets

Power is always available, regardless of the unit's power switch setting.

For amplifier: Audio equipment rated up to 100W (total for all outlets) can be connected here.

For compact disc player: Audio equipment rated up to 100W can be connected here.

For graphic equalizer: Audio equipment rated up to 150W can be connected here.

For AV surround processor: Audio equipment rated up to 100W can be connected here.

Note: If the "AC IN" of the amplifier is connected to the "SWITCHED" outlet of the tuner, power for each unit is only available when the tuner's power switch is "on".

■ "SWITCHED" outlet

Power is controlled by power switch of the tuner.

For tuner: Audio equipment rated up to 460W can be connected here.

System with compact disc player, graphic equalizer and AV surround processor

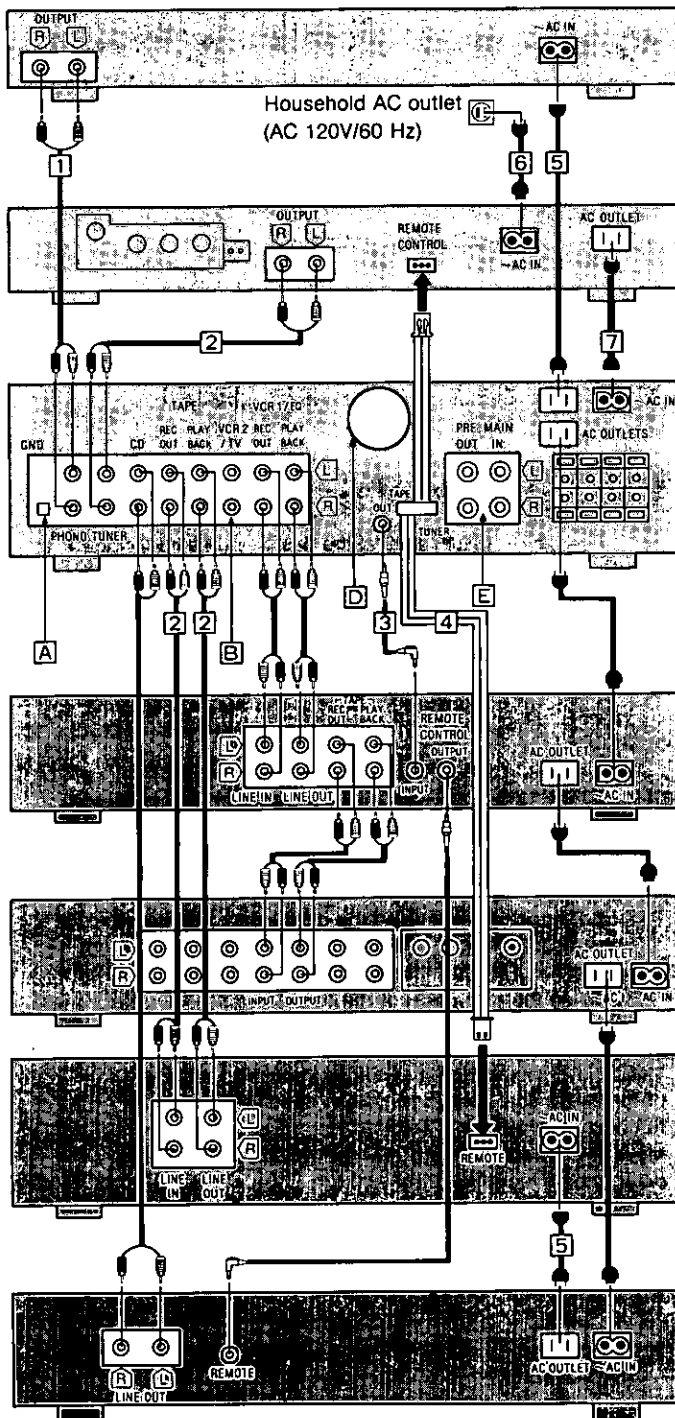

System Connection Options

A "GND" terminal of the amplifier

This terminal is for use with a turntable which has a ground wire.

B "VCR 2/TV" terminals of the amplifier

For connection to the audio output of a VCR, TV, etc. (Refer to the operating instructions of the optional equipment.)

C "VCR 1/EQ" terminals of the amplifier

For connections to the audio inputs and outputs of a VCR, EQ, etc. (Refer to the operating instructions of the optional equipment.)

D Cooling fan of the amplifier

The cooling fan operates only at high output power levels.

E "PRE OUT/MAIN IN" terminals of the amplifier

Use these terminals to operate the amplifier as an independent preamplifier, main amplifier.

Do not remove these pins otherwise.

(No sound will be heard if they are removed.)

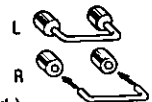

Antenna Connections

Note:

An outdoor antenna should be installed by a competent technician only.

FM outdoor antenna (option)

(Necessary in mountainous regions, inside reinforced-concrete buildings, etc.)

Note:

75-ohm coaxial cable or 300-ohm feeder wire may be used for connection from the antenna. Coaxial cable is suggested for best resistance to external interference noise.

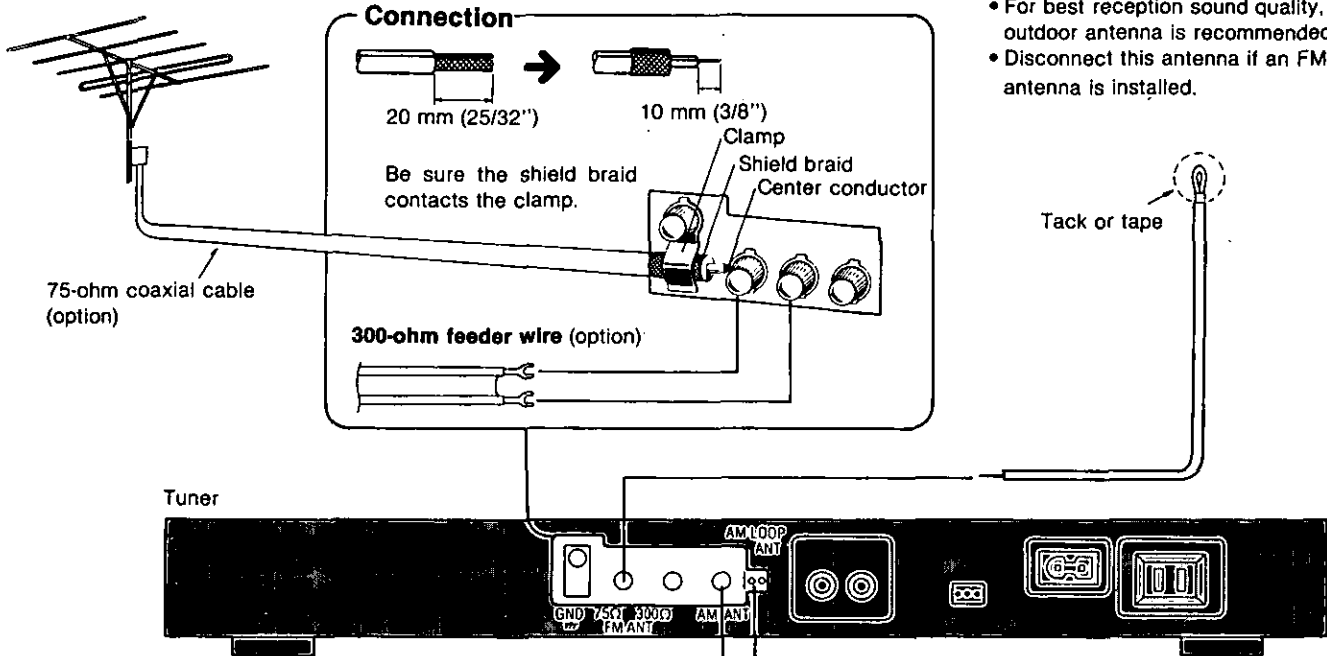

FM indoor antenna (included)

- Attach to a wall (using tack or tape) facing in the direction of best reception.
- Tack should not contact internal antenna wire.
- For best reception sound quality, an FM outdoor antenna is recommended.
- Disconnect this antenna if an FM outdoor antenna is installed.

AM outdoor antenna (option)

(Necessary in mountainous regions, inside reinforced-concrete buildings, etc.)

Use 5 ~ 12 m (16 ~ 40 ft.) of vinyl-covered wire horizontally at the window.

Note:

When the unit is not in use, disconnect the outdoor antenna to prevent possible damage that may be caused by lightning. Never use an outdoor antenna during an electrical storm.

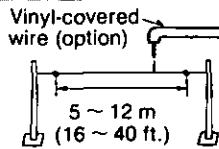

AM loop antenna (included)

After finding the best reception position for the antenna, fix it to a wall, the rack, or the amplifier, etc.

Note:

If this antenna is not properly installed, AM broadcasts will not be received. Be sure to connect the AM loop antenna even when an outdoor antenna is used.

Installation of the AM loop antenna

1. Pay attention to the following points when attaching the antenna.
 - Do not attach it horizontally (to do so would impair reception).
 - Do not attach it close to metal surfaces (to do so would result in noise).

When attaching the antenna to a wall, column or rack

Find the height and direction of the antenna where reception is best and then fix it vertically to the wall, rack, etc.

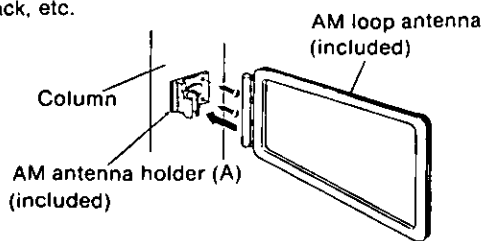

2. Connect the AM loop antenna to the AM antenna terminals located on the rear panel of the tuner.
 - Do not attach it close to power cords, speaker wires, etc. (to do so would result in noise).
 - Do not attach it close to a tape deck (when the tape deck is being used, chirping or beeping sounds may be received).

When attaching the antenna to the amplifier

This type of installation may cause impaired reception or result in signal noise. If possible, attach the antenna to the rack, a wall, or a column.

Move the antenna toward the right or left to find the point of best reception.

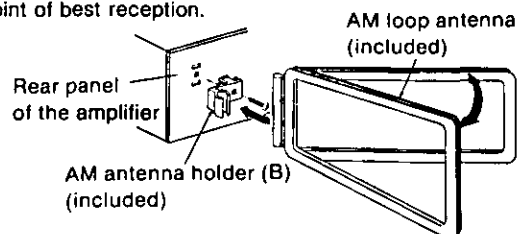

Front Panel Controls and Functions

Quartz Synthesizer AM/FM Stereo Tuner

FM stereo indicator (stereo)

This indicator automatically illuminates when an FM stereo broadcast is being received.

Note:

It will not illuminate if the FM mode selector is pressed.

Quartz-lock indicator (quartz lock)

This indicator illuminates when tuned precisely to an FM or AM station.

Power indicator (standby)

When the power switch is set to the "on/standby" position, this indicator illuminates to indicate that the unit is in operation.

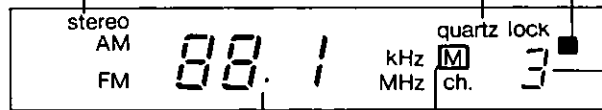

Channel display

The channel number selected by the preset-tuning buttons is displayed.

Digital frequency display

The reception frequency of the FM or AM broadcast selected by using the tuning buttons or the preset-tuning buttons is indicated.

Memory indicator (M)

This indicator illuminates when the memory button is pressed.

Power switch (power)

Remote-control signal receptor (remote sensor)

Receives the signals from the remote-control transmitter.

Tuning buttons (tuning)

These buttons are used for tuning to the desired broadcast station. If the button is pressed momentarily and then released, the frequency will change at intervals of 0.1 MHz for FM and 10 kHz for AM.



Preset-tuning buttons (1 ~ 0) (24 channel random preset tuning)

These buttons are used to preset FM and AM broadcast frequencies into the memory of this unit, and are also pressed to select the desired preset frequencies. (Refer to page 14.)

Band selectors (band)

FM: Press this button to listen to an FM broadcast.

AM: Press this button to listen to an AM broadcast.

Memory button (memory)

This button is used when setting a frequency to a certain preset channel (1~24). (Refer to page 14.)

FM mode selector (FM mode)

This unit automatically switches to the stereo mode when a stereo broadcast is received. Press this selector to listen in the monaural mode. The FM stereo indicator will not illuminate in the monaural mode.

DC Servo Automatic Turntable System

45-rpm adaptor

For a 17 cm (7") (large center hole) record, use the 45-rpm adaptor.

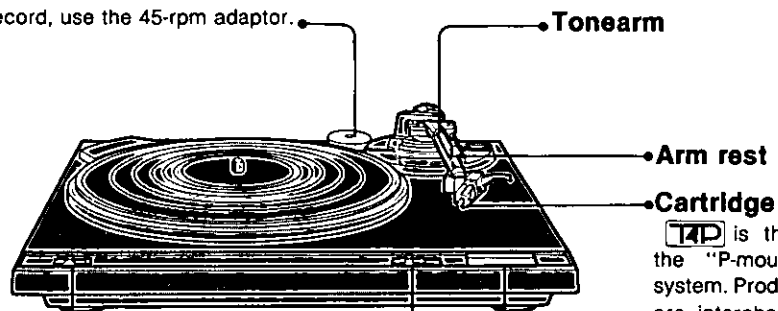

Speed selector (speed)

Cueing switch (cueing)

Stop switch (stop)

14P is the standard mark for the "P-mount" plug-in-connector system. Products carrying this mark are interchangeable and compatible with each other.

Front Panel Controls and Functions

(continued)

Stereo Integrated Amplifier

Power switch (power)

Peak-power indicators (power level)

These indicators indicate the peak power value of the output level to the speaker systems.

Input selector/volume level display (input)

This display usually shows the sound source selected by the input selectors; when the volume-control is used to adjust the volume level, the volume level is displayed in decibel for about three seconds, after which the display returns again to indication of the sound source.

Muting indicator (mute)

This indicator will illuminate when the muting button on the remote-control transmitter is pressed. (Refer to the operating instructions of remote-control transmitter.) To cancel the muting function without the remote-control transmitter, press both "phono" and "VCR 2/TV" buttons of the input selectors on this unit at the same time, after reducing the volume level to the minimum position.

Super bass switch/indicator (super bass)

Low frequency sounds are reinforced when this switch is pressed. The indicator at the left will illuminate.

Volume control (volume)

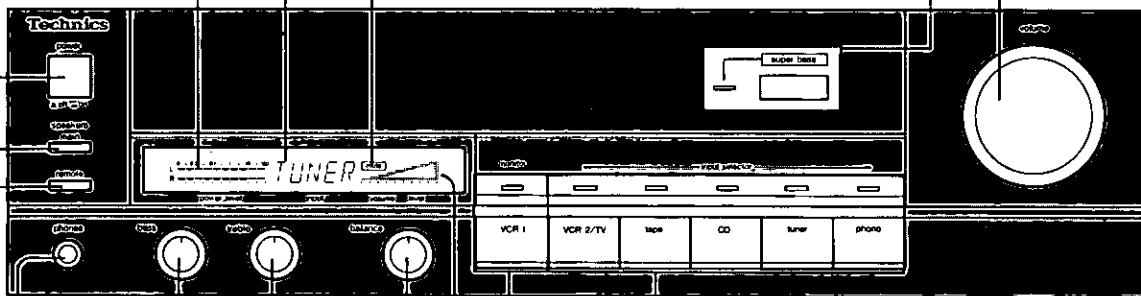

Tone controls (bass/treble)

The bass control is for the low-frequency sound range, and the treble control is for the high-frequency sound range.

Headphones jack (phones)

Speaker selectors (speakers)

These selectors are used to turn the speaker systems on and off.

Note:

When only one speaker system is connected to the amplifier, no sound will be heard if both the speaker selectors are pressed.

Input selectors/indicators (input selector)

These selectors are used to select the sound source to be heard, such as a disc, radio broadcasts, etc. The corresponding input selector indicator illuminates during operation to indicate the selected sound source. The selected sound source is also shown on the input selector/volume level display.

VCR 1-monitor switch/indicator (VCR 1)

Press this switch so that the indicator above is illuminated when using a graphic equalizer or, playing back or monitoring the sound from a VCR connected to the "VCR 1/EQ" terminals. This selector should be set to the position (indicator off) at all other times.

Volume indicator (volume level)

Balance control (balance)

This control is used to adjust left/right volume balance.

Stereo Double Cassette Deck

• **Power switch (power)**

• **"DECK A" counter/reset button (DECK A counter/reset)**

This indicates the amount of tape travel of "DECK A". When this button is pressed, the readout will be reset to "000".

• **Recording indicator (rec indicator)**

This indicator illuminates during tape recording, and recording stand-by mode.

• **Tape-select indicators (Auto Tape Select)**

The tape selector setting changes automatically, and the indicator indicates the type of tape being used in "DECK A".

• **Recording level control (rec level)**

Used to adjust the recording level.

• **Editing/auto space switch (editing/auto space)**

(Refer to pages 18 ~ 19.)

• **Editing tape-speed selector (editing speed)**

Press to select the tape speed for edit-recording.

• **Level meters (peak level)**

During recording, these meters indicate the recording level. The level is adjusted by using the recording level control. During playback, they indicate the level of the recorded sound.

• **Dolby noise-reduction switch (Dolby NR)**

(Refer to page 17.)

• **Cassette holder**

• **Cassette holder**

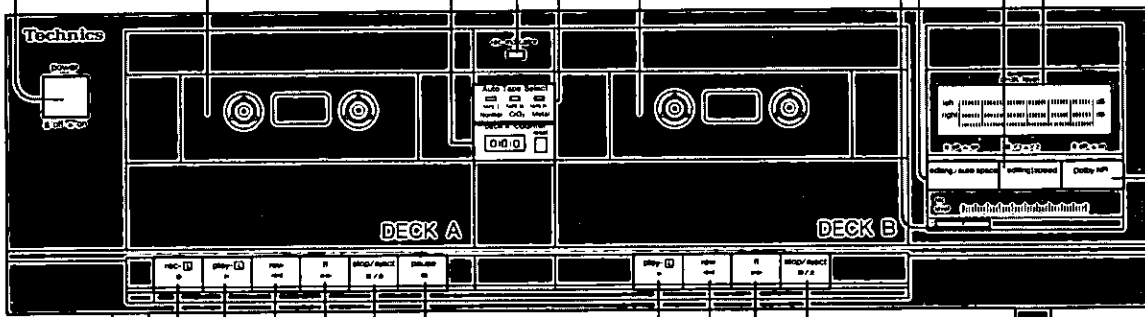

• **Pause button (pause/II)**

• **Stop/eject button (stop/eject/■/▲)**

Press this button to stop the tape during recording or playback, and to open the cassette holder.

• **Fast-forward button (ff/▶▶)**

• **Rewind button (rew/◀◀)**

• **Playback button (play- ◻ /▶)**

• **Record button (rec- ◻ /●)**

Press this button to record.

• **Stop/eject button (stop/eject/■/▲)**

Press this button to stop the tape during playback, and to open the cassette holder.

• **Fast-forward button (ff/▶▶)**

Press this button to advance the tape rapidly.

• **Rewind button (rew/◀◀)**

Press this button to rewind the tape rapidly.

• **Playback button (play- ◻ /▶)**

Press this button to playback.

When using "DECK A"

When using "DECK B"

Standard Operating Procedures

Before listening to a disc, radio broadcast, etc., (steps 1, 2, 3)

1 Power: "on" (→)

(The power indicator will illuminate.)

2 Select the main and/or remote speaker systems to be used.

Note: When only one system of speakers is connected, no sound will be heard if both speaker selectors are pressed.

When listening through headphones

If sound from the speakers is not wanted, set the speaker selectors to the "off" position.

Notes:

- Set the volume level of the amplifier to a minimum before connecting headphones.
- Plug type: 1/4 inch phone plug, stereo type

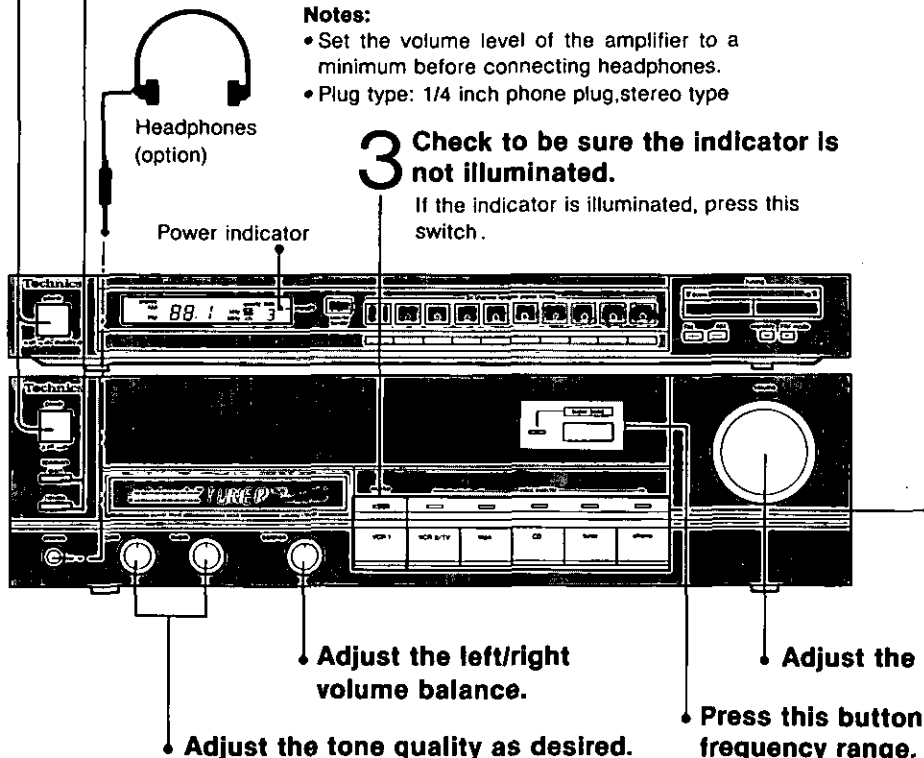

3 Check to be sure the indicator is not illuminated.

If the indicator is illuminated, press this switch.

Select the sound source

■ Listening to phono discs

Press the "phono" button. (Refer to page 13.)

■ Listening to radio broadcasts

Press the "tuner" button.

(Refer to pages 14 ~ 15.)

■ Listening to compact-discs

Press the "CD" button.

(Refer to the operating instructions of the compact disc player for details.)

■ Listening to tapes

Press the "tape" button.

(Refer to pages 16 ~ 17.)

■ Listening to VCR, TV, etc

Press the "VCR 2/TV" button.

(Refer to the operating instructions of the optional equipment for details.)

■ Remote-control operation

The remote-control transmitter included with this unit can control not only selected Technics tuners, cassette decks, graphic equalizers and compact disc players, but also any Panasonic remote controlled TV and/or VCR.

During remote-control operation, the amplifier's input selector setting will change automatically (corresponding to the function selected by the remote-control transmitter). (Refer to the operating instructions of the remote-control transmitter for details about the functions available on the remote-control transmitter.)

While listening to music

• Adjust the left/right volume balance.

• Adjust the volume level.

• Adjust the tone quality as desired.

• Press this button to boost the ultra-low frequency range. (The indicator will illuminate.)

For systems with a graphic equalizer

1. Press the VCR 1-monitor switch of the amplifier.

(The indicator will illuminate.)

2. Adjust the tone quality as desired.

(Refer to the operating instructions of the equalizer for details.)

For systems with an AV surround processor

1. Select the desired audio source on the amplifier.

2. Set the input selector of the AV surround processor to "Source".

3. Adjust the surround-sound effect.

(Refer to the operating instructions of the AV surround processor for details.)

After listening is finished

Be sure to reduce the volume level, and switch OFF the power to each unit.

Listening to Phono Discs

Have you completed the "Standard Operating Procedures" (page 12)?

- 1 Press the input selector on the amplifier marked "phono."**
(The input selector/volume level display on the amplifier shows "PHONO".)

2 Place a disc on the platter mat.

3 Set to the appropriate speed.

4 Set to "▼".

5 Remove the stylus protector.
(The tape on side of cartridge prevents the stylus assembly from shaking loose during shipment.)

6 Move to the desired position.
(The platter will start turning.)

7 Set to "▼".
(Play will start.)

8 Adjust the volume level and the tone quality as desired.
(Refer to page 12.)

Turntable

Set to "▼" to stop the play temporarily. Set to "▼" to resume the play.

Press to stop the play.

Stylus protector

■ For a 17-cm (7") (large center hole) disc

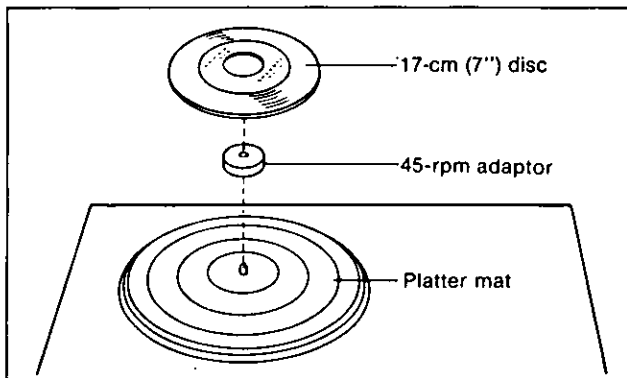

■ When play ends

The tonearm will automatically return to the arm rest (the automatic return feature.)

■ After use

Attach the stylus protector.

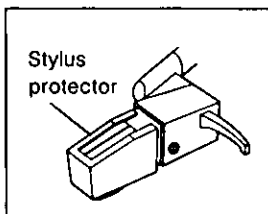

■ Operation note

When the unit is used for the first time, or after it has been moved from one place to another, it may happen that the automatic return function might not operate correctly due to vibrations during transport or movement. If this happens, press the stop switch. (The tonearm will return and thereafter the operation will be normal.)

Memory Presettings

With this unit you may preset as many as 24 radio broadcast stations: FM/AM random presetting. After broadcast stations have been preset as described below, any desired station can be quickly and easily selected. Stations can be freely preset to any desired channel.

Have you completed the "Standard Operating Procedures" (page 12)?

- 1** Press the input selector on the amplifier marked "tuner".
(The input selector/volume level display on the amplifier shows "TUNER".)

- 3** Press the appropriate tuning button to tune to the desired broadcast.

Tuning

Press the left button to change the frequency downward, and press the right button to change the frequency upward.

• Automatic tuning

Press the button. When the frequency indication begins to change, release the button (a broadcasting station will be selected automatically). Repeat this operation until the desired station is found.

• Manual tuning

- ① Press the button and hold slightly (frequency will change continuously).
- ② Release it when approaching the desired exact frequency, and then press the button again momentarily (frequency change will stop).
- ③ Press the button momentarily (frequency will change each time the button is pressed), and tune to the desired frequencies.

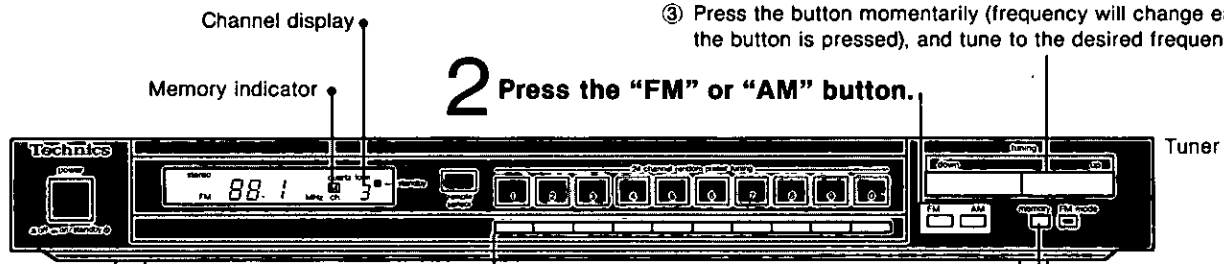

- 5** Select the desired "channel".
[A maximum of 24 broadcast stations (AM and/or FM) can be memorized.]

Example:

To select "channel" 12:

Press **1** and then **2**.

Note:

Make the entry without interruption between steps. If there is an interval of about two seconds or more between steps, you may not obtain the desired settings. In this case, perform steps 4 - 5 again to reset the memory as necessary.

(If the correct presetting cannot be confirmed on the channel display, then reset the memory.)

- 4** Press.
(The memory indicator will illuminate.)

- 6** Enter the name (call sign, etc.) of the preset broadcasting station on the station memory file sheet. (Refer to page 15.)

This completes the procedures for presetting radio broadcast frequencies. The other preset-tuning buttons can be preset in the same way by following steps 2 through 6.

Note:

If a new broadcasting station is preset into a channel, the broadcasting station which was previously entered in that channel will be automatically erased.

"Most-recent" memory

The most-recent memory is a system by which the unit "remembers" the FM or AM broadcast station last heard when this unit is switched OFF, and automatically tunes to that station the next time the power is switched ON.

"Back-up" memory

This is the function which preserves the preset memory and most-recent memory functions. In the event of a power failure, or if the unit is not used for a long period of time, the back-up memory will preserve the preset memory and most-recent memory functions for as long as approximately one month.

To prevent erasing the memory

The memory settings will be erased in the following cases.
For example:

- 1) If the unit is not used for one month or longer,
- 2) If an audio timer is used and the timer does not operate this unit for one month or longer,
- 3) If a power failure occurs, etc.

If any of the above occurs, the memory will have to be reset. If the power supply is interrupted for one month or longer, set the power switch of the tuner to the "on" position for an hour or more. Then reprogram the memory.

Listening to Radio Broadcasts

Have you completed the "Standard Operating Procedures" (page 12) and "Memory Presettings" (page 14)?

- 1 Press the input selector on the amplifier marked "tuner".
(The input selector/volume level display on the amplifier shows "TUNER".)

- 2 Press the desired channel (1 - 24).

Note:

When selecting channel 1 or channel 2, enter the selection as "01" or "02". If only "1" or "2" is pressed, channel access will be delayed by two seconds.

Station selection by using the tuning buttons:

Follow steps 2, 3 of "Memory Presettings" on page 14.

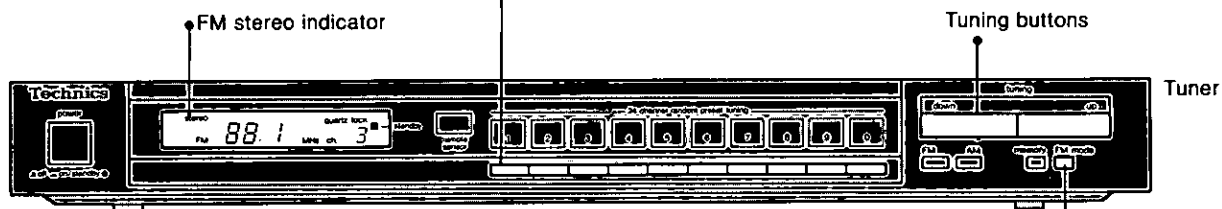

- 3 Adjust the volume level and the tone quality as desired.
(Refer to page 12.)

FM mode selector

If the broadcast signal is weak, or if there is a large amount of interference in a stereo broadcast, set to the monaural mode. Note that the FM stereo indicator will not illuminate in the monaural mode.

Note:

To prevent noise while listening to an FM or AM broadcast, switch OFF the compact disc player.

Station Memory File Sheet



Channel	CH. 1	CH. 2	CH. 3	CH. 4	CH. 5	CH. 6	CH. 7	CH. 8
Station								
Channel	CH. 9	CH. 10	CH. 11	CH. 12	CH. 13	CH. 14	CH. 15	CH. 16
Station								
Channel	CH. 17	CH. 18	CH. 19	CH. 20	CH. 21	CH. 22	CH. 23	CH. 24
Station								

Listening to Tapes





Note:

"DECK A" and "DECK B" cannot both be used for playback at the same time.

Have you completed the "Standard Operating Procedures" (page 12)?

1 Power:
"on" ( → )

2 Press the input selector on the amplifier marked "tape".
(The input selector/volume level display on the amplifier shows "TAPE".)

3 "off" ( → )
For playing back tapes which were not recorded through a Dolby noise-reduction system.
"on" ( → )
For playing back tapes which were recorded through a Dolby noise-reduction system. (Refer to page 17.)

When using "DECK A"

4 Press, then insert the tape to be used for playback.

5 Press.
(Playback will begin.)

When using "DECK B"

4 Press, then insert the tape to be used for playback.

5 Press.
(Playback will begin.)

The side to be played back facing outward.

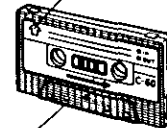

Part where tape is exposed facing downward.

6 Adjust the volume level and the tone quality as desired.
(Refer to page 12.)

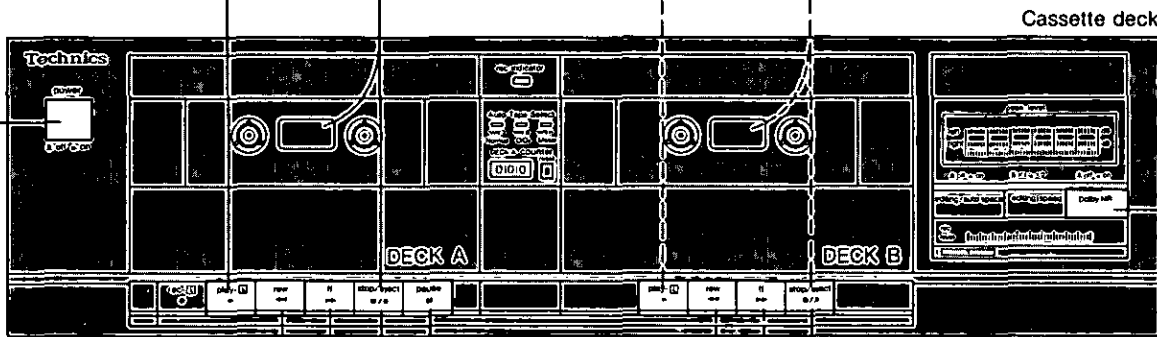

Press to rewind the tape.

Press to advance the tape.

Press to stop the tape.

Press to stop the tape temporarily.

Press to stop the tape.

Press to advance the tape.

Press to rewind the tape.

Dolby noise-reduction system

The Dolby-noise reduction system boosts low level high frequency signals during recording. During playback, these high frequency signals are reduced by a corresponding amount and, therefore, noise is reduced.

This unit uses the Dolby-B type noise-reduction system.

- Dolby noise reduction manufactured under license from Dolby Laboratories Licensing Corporation.
- "DOLBY" and the double-D symbol  are trademarks of Dolby Laboratories Licensing Corporation.

Series playback

Continuous playback from one side of a tape in "DECK A" to one side of a tape in "DECK B" (or from "DECK B" to "DECK A") is possible. To do so, simply follow the steps below instead of step 5 on page 16.

When starting from "DECK A"

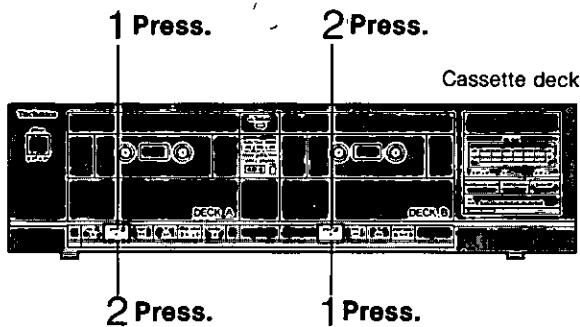

When starting from "DECK B"

Automatic tape selector system

This cassette deck automatically detects the type of tape being used, and adjusts for the proper bias and equalization.

The tape-select indicator indicates the type of tape being used in "DECK A".

"Metal" lights when no tape has been loaded in the cassette holder of "DECK A".

Notes about cassette tapes

Selection of cassette tapes

Do not use the following types of tapes in this unit.

• 120 minute (or longer) tapes

Because the tape is very thin, it may stretch during use causing unstable tape movement which may result in the tape becoming tangled in the rotating parts of this unit.

• Fe-Cr tapes

The high frequency range will be emphasized and it will not be possible to obtain a flat frequency response.

• Metal tape without detection holes

Recordings will be very distorted. (There is no playback problem however.)

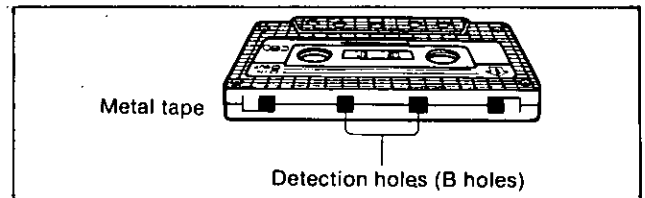

Tape slack

This may cause the tape to break.

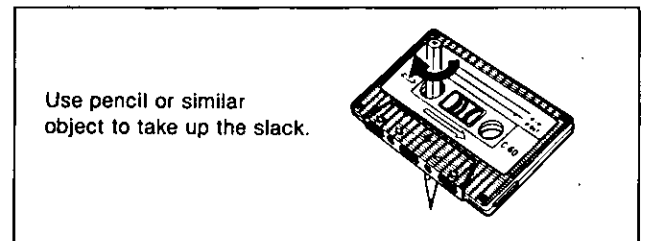

To prevent erasing of recorded sounds

Remove the erase-prevention tabs (thus preventing recording).

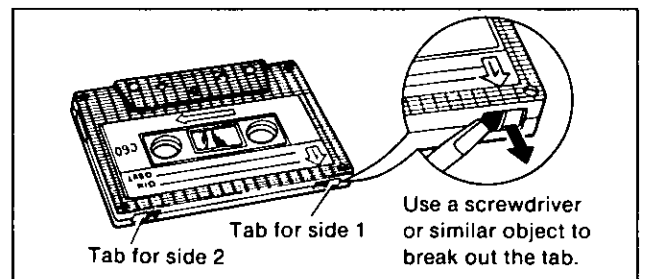

To record again

Cover the slot with adhesive tape.

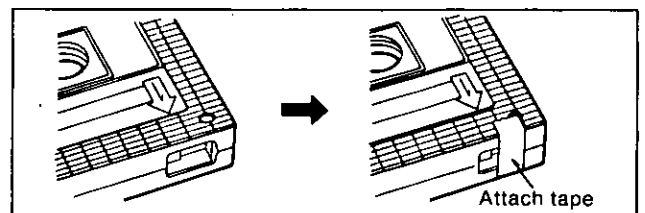

Avoid tape storage in the following places



- Where the temperature is high (95° F/35° C or higher) or where the humidity is high (80% or higher).
- Where there is a strong magnetic field (near a speaker, on top of a TV, etc.).
- In direct sunlight.

Recording

Note:

Only "DECK A" can be used for recording.
"DECK B" has no record capability.

Have you completed the "Standard Operating Procedures" (page 12)?



1 Power: "on"
( → )

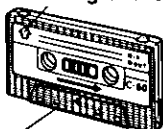

2 Press, then insert the tape to be used for recording.

The side to be recorded facing outward.





Part where tape is exposed facing downward.

3 "off" ( → )

4 "off" ( → )

Tape recording without the Dolby noise-reduction system.

"on" ( → )

Tape recording with the Dolby noise-reduction system.
(Refer to page 17.)

6 Press.
The recording indicator will be illuminated.
(Recording stand-by mode)

5 Press.

9 Press.
(Recording will begin.)

7 Begin the sound source to be recorded.
(Refer to pages 13 ~ 17.)

8 Adjust the recording level.
(See below.)

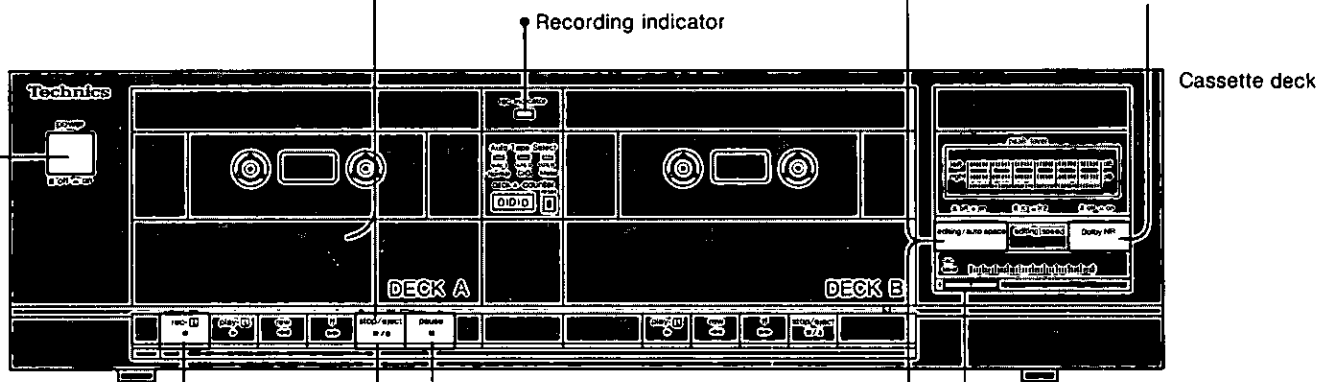

Press to stop the recording.

Press to stop the recording temporarily.

Press to make non-recorded spaces between tunes. (See below.)

Adjustment of the recording level

The actual level which you should use as a guide for adjusting the recording level may vary depending on the type of tape used.

Tape type	Normal (TYPE I) CrO ₂ (TYPE II)	Metal (TYPE IV)
Level (Dolby NR off)	0dB	+3dB
Level (Dolby NR on)	+3dB	+6dB

Note:

The recording level might not be adjustable when the stop button on the remote-control transmitter is pressed.
If this happens, press the "play" button on the remote-control transmitter.

To make non-recorded spaces

With this unit, by following the steps below, it is possible to make non-recorded spaces (4 seconds long) between tunes.

- **During recording, press the editing/auto space switch.**
After about 4 seconds, "DECK A" will automatically change to the recording stand-by mode.
- **To start the recording again, set the switch to the "off" position.** (Recording will begin.)

Edit-Recording

"Edit-recording" is recording from one tape to another while making some changes.

1 Power: "on"
(**■** → **■**)

2 Press, then insert the tape to be used for recording.

3 Press, then insert the tape to be used for playback.

4 "on" (**■** → **■**)

5 Select the tape speed.
"■ × 2":
 For operation at double speed
"■ × 1":
 For operation at the normal tape speed

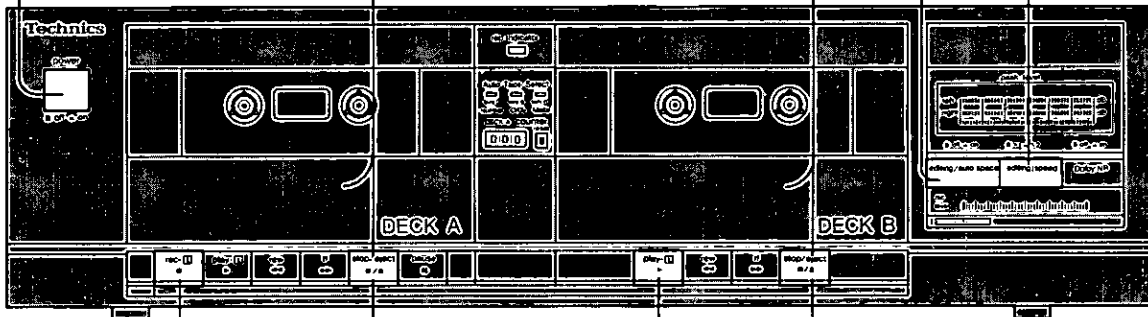

Cassette deck

6 Press.
 The recording indicator will be illuminated.
 (recording stand-by mode)

7 Press.
 ("DECK B" playback and "DECK A" recording will then begin.)

- Press to stop the edit-recording.
 After about 4 seconds, "DECK A" will automatically change to the recording standby mode. (This will make a non-recorded space between tunes.)
 To start edit-recording again, press the playback button on "DECK B".

Notes:

- In order to avoid incorrect operation, be sure to set the editing/auto space switch to "off" and press the stop/eject button of "DECK A" after the edit-recording is finished.
- Recording level as well as equalizer effects and Dolby noise-reduction effects are recorded on to the tape in "DECK A" exactly as they were originally recorded on the tape in "DECK B".
- During edit-recording, the recording level control, Dolby noise reduction button and the remote control will have no effect on the tape deck.
- To avoid changes of the tone quality, use the same type of tape in "DECK A" as the type to be played back in "DECK B".

To find the tune you want to record

- ① Press the pause button of "DECK A".
- ② On "DECK B", find the tune you want to record.
- ③ Release the pause button of "DECK A".
- ④ Press the play button of "DECK B".

Recording (continued)

To record while using the graphic equalizer

1. Press the VCR 1-monitor switch on the amplifier.
(The indicator will illuminate.)
2. Refer to the operating instructions of the equalizer used for details and proper switch settings.

To erase recorded sounds

1. Insert the recorded tape into the holder of "DECK A".
2. Set the Dolby noise-reduction switch to the "off" position.
3. Set the recording level control to the minimum ("0") position.
4. Press the record button, and then let the tape run.

Note that any sounds on the tape will be automatically erased if a new recording is made on that part of the tape.

Timer Recording/Playback

If an audio timer (option) is connected to this unit, recording or playback of an audio source will automatically begin at the preset time.

Connections

Connect the power cord from the tuner to the AC outlet of the timer so that the power of the tuner can be turned on and off when the power of the timer is turned on and off.

Operation

When setting the timer for timer-controlled recording or playback, the timer should be set to a time which will extend beyond the time of one side of the tape.

This is because, if the timer switches OFF before the tape reaches its end, the capstan and pinch roller remain pressed together, which might adversely affect their performance.

Timer recording

1. **Prepare for recording.**
(Follow steps 1 through 8 of "Recording" on page 18. After adjusting the recording level, press the stop/eject button and the pause button.)
2. **Set the timer to the desired recording-start time.** (Power will be off.)
3. **Press the record button.**
(At the specified time, the power will come on and the audio source will be recorded.)

After setting the timer

Make sure that the power switches of the cassette deck, amplifier and audio source to be recorded are set to the "ON" position.

Timer playback

1. **Rewind the tape to the position from which you want playback to begin.**
2. **Set the timer to the desired playback-start time.** (Power will be off.)
3. **Press the playback button of whichever deck you want to use, "DECK A" or "DECK B".**
(At the specified time, the power will come on and playback will begin.)
Note:
For timer playback, playback always starts from "DECK A" in the series playback mode.

After setting the timer

Make sure that the power switches of the amplifier, tuner and audio source to be played back are set to the "ON" position.

Adjustment

Adjustment of the automatic-return position

Make this adjustment if the tonearm doesn't return automatically to the arm rest, or if it returns before the tune ends.

1. Adjust to the desired automatic-return position.
2. Check to be sure the automatic-return position is correct.

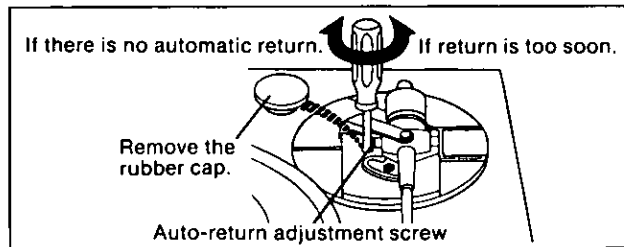

Adjustment of the stylus-to-disc clearance

This adjustment is preset at the factory. This adjustment should not be necessary unless the cartridge or stylus is changed.

1. Set the cueing switch to "▼".
2. Move the tonearm to a position above the disc.
3. Adjust the stylus tip position.

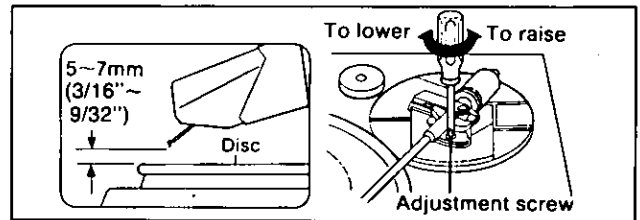

Maintenance

To clean dust from the stylus

Use a soft brush or similar material to gently remove the dust.

Thoroughly clean your discs occasionally with a high-quality disc cleaner.

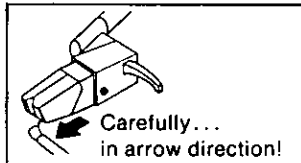

Replacement of the stylus

If noise is heard from new discs, the stylus is probably worn. Replace it with a new one.

- Stylus life..... approx. 1000 hours
- New stylus EPS-24CS

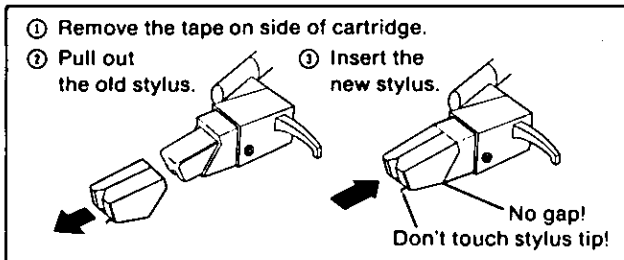

Replacement of the cartridge

TP is the standard mark for the "P-mount" plug-in-connector system. Products carrying this mark are interchangeable and compatible with each other.

The plug-in type of cartridge is already designed to match this unit in every respect: weight, correct stylus pressure, stylus tip position, center of gravity, etc. This means that there's no longer any need for troublesome connection of lead wires or adjustment of the stylus pressure.

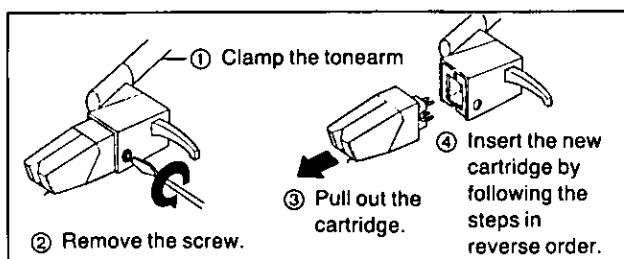

Head cleaning

To assure sound quality for recording and playback, be sure to clean the heads after approximately every 10 hours of use.

- 1) Press the power switch to switch off the electrical power supply of the cassette tape deck.
- 2) Press the stop/eject button to open the cassette holder.
- 3) Clean the heads, pinch roller and the capstan shaft with a cotton swab (or with a soft, lint-free cloth) slightly moistened with alcohol.

Do not use any solution other than alcohol for head cleaning.

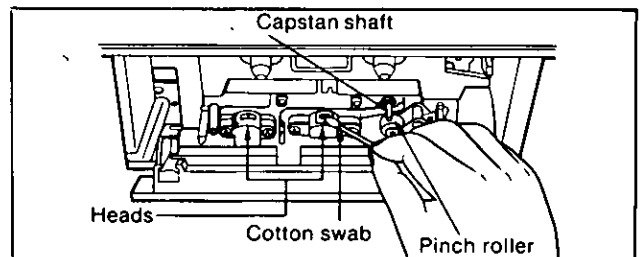

Head demagnetization

In order to maintain good sound quality during recording and playback, it is recommended that the head assembly be demagnetized when distortion or poor sound quality persist after cleaning the heads.

If the head assembly becomes magnetized, it could create noise in the recordings, loss of high-frequency response or erasure of valuable recordings. Several types of head demagnetizers are available and may be purchased separately at local electronics supply stores. Follow the instructions that are supplied with the device.

- Do not bring any type of metal objects or tools such as magnetic screwdrivers in contact with the head assembly.

Maintenance of external surfaces

To clean this unit, use a soft, dry cloth.

If the surfaces are extremely dirty, use a soft cloth, dipped into a soap-and-water solution or a weak detergent solution. Wring the cloth well before wiping the unit.

Wipe once again with a soft, dry cloth.

Never use alcohol, paint thinner, benzene, nor a chemically treated cloth to clean this unit.

Such chemicals may damage the finish of your unit.

Troubleshooting Guide

Before requesting service for this unit, check the chart below for a possible cause of the problem you are experiencing. Some simple checks or a minor adjustment on your part may eliminate the problem and restore proper operation.

If you are in doubt about some of the check points, or if the remedies indicated in the chart do not solve the problem, refer to the directory of Authorized service centers (enclosed with this unit) to locate a convenient service center, or consult your Technics dealer for instructions. (In U.S.A. consult MSC Authorized Servicenters for detailed instructions.)

Problem	Probable cause(s)	Suggested remedy
Problems noted at all times		
No sound is heard when the power is switched ON.	The power cord plug is not completely inserted.	<ul style="list-style-type: none"> • Confirm that the power cord plug is connected completely.
	The incorrect input selector of the amplifier has been pressed.	<ul style="list-style-type: none"> • Check to be sure that the correct selector is pressed.
	Connections are incomplete or incorrect to the speaker systems, etc.	<ul style="list-style-type: none"> • Check to be sure that all connection wires are correctly connected.
	The VCR 1-monitor switch is incorrectly set.	<ul style="list-style-type: none"> • Except for tape playback, set the switch to the position (indicator off).
	The speaker selectors are incorrectly set to the "off" position.	<ul style="list-style-type: none"> • Set it to the "on" position.
When listening to stereo sound, the left and right sounds are reversed.	The left and right connections of the connection cables connected to other equipment are reversed.	<ul style="list-style-type: none"> • Check to be sure the connection cables to other equipment and connect them correctly if necessary.
When listening to stereo sound, the sound lacks depth (i.e. thin bass, thinny sound).	Out of the speaker is connected out of phase [(+)-(-), (-)-(+)].	<ul style="list-style-type: none"> • Reconnect the speakers maintaining proper polarity [i.e., (+)-(+), (-)-(-)].
A low-pitched noise ("hum" or "buzz") is heard.	The power cord or a fluorescent light, etc., is near the connection wires.	<ul style="list-style-type: none"> • Try separating the amplifier from the electric appliance as far as possible.
Sound is not heard from the speaker system on one side.	The balance control of the amplifier is set too far to one side.	<ul style="list-style-type: none"> • Set so that sounds are heard at the center, between the speaker systems.
	The speaker connection wires are disconnected.	<ul style="list-style-type: none"> • Check and correct the connections of the speaker connection wires.
Sound stops during a performance, or no sound is heard when the power is switched ON.	The protection circuitry has functioned because the positive and negative speaker connection wires are "shorted" or speaker systems with an impedance less than the indicated rated impedance of the amplifier are used.	<ul style="list-style-type: none"> • Switch off the power, and, after determining and correcting the cause, switch on the power once again.
While listening to radio broadcasts		
A strange hissing noise is produced continuously or intermittently.	Caused by the "discharge phenomenon" and the "oscillation phenomenon" of electric appliances (such as fluorescent lights, TV, small series-type motors, rectification equipment, etc.).	<ul style="list-style-type: none"> • Try placing this unit farther away from such equipment. • Install noise-prevention equipment on this unit or on the electric appliance.
While listening to AM broadcasts		
An unusual "beat" sound is heard.	Unit is being used at the same time as the television set.	<ul style="list-style-type: none"> • Turn off television set, or use the tuner farther away from it.
	Interference from adjacent broadcast signal.	<ul style="list-style-type: none"> • Try reducing the treble sound by using the treble control of the amplifier.
A low-pitched "hum" sound is heard when the broadcast is tuned.	The AM loop antenna connection wires are too close to the power cord.	<ul style="list-style-type: none"> • Place the antenna connection wires and the power cord farther apart.
	The power supply frequency from the power cord is modulated and heard from the speakers.	<ul style="list-style-type: none"> • Install a special outdoor antenna.
No broadcast reception.	The AM loop antenna is not connected, or the connection is not tight at the antenna terminal.	<ul style="list-style-type: none"> • Connect it correctly.

Problem	Probable cause(s)	Suggested remedy
While listening to FM broadcasts		
An unusual hissing noise is heard when listening to the broadcast in stereo, but not heard when listening monaurally.	Due to the differences between a monaural and a stereo signal, a higher level of signal strength is required for proper stereo reception. If the signal level is low, a hissing noise may be produced on the stereo channel.	<ul style="list-style-type: none"> • Set the FM mode selector of the tuner to the monaural position. (Note that the broadcast will then be heard as monaural sound.) • If an indoor antenna is being used, change to an outdoor antenna. • Try using an antenna with more elements.
Noise is excessive in both stereo and monaural broadcasts.	Poor location and/or direction of the antenna. Transmitting station is too far away.	
The FM stereo indicator or the quartz lock indicator flickers, without completely illuminating.	Poor location and/or direction of the antenna. Transmitting station is too far away.	<ul style="list-style-type: none"> • Try changing the location, height and/or direction of the antenna. • Try using an antenna with more elements. • If an indoor antenna is being used, change to an outdoor antenna. • Install a special outdoor antenna.
Sound is distorted, "popping" noise is heard, and/or the volume level becomes low.	Broadcast signals are being disturbed by nearby automobile traffic or airplanes. Such noise is called ignition noise, and occurs while the automobile engine is running.	<ul style="list-style-type: none"> • Relocate the antenna and the connection wires to a place farther away from where automobiles pass.
Excessive distortion in the sound of stereo broadcasts.	Nearby building or mountain. [Multipath distortion is being caused by the mutual interference of broadcast signals received directly from the transmitting station (direct waves) and signals being reflected from nearby buildings or mountains (reflected waves).]	

While using the tape deck		
Sound is low, poor tone, intermittent sound, noise.	Heads, capstan and/or pinch roller are dirty or the tape is damaged.	<ul style="list-style-type: none"> • Clean the heads, capstan and/or pinch roller, or try a new cassette tape.
Poor sound quality (especially in the high treble and low bass ranges)	The proper Dolby noise-reduction switch is not selected.	<ul style="list-style-type: none"> • Select the correct switch.
Previously recorded sound has not been erased.	Erase head is dirty.	<ul style="list-style-type: none"> • Clean the head.
Sound output is hoarse or unsteady.	Heads are dirty. Tape is damaged.	<ul style="list-style-type: none"> • Clean the heads. • Try operation with a new cassette tape, and, if there is no problem, replace the cassette which is damaged with a new one.
Distorted sound	The recording level is too high.	<ul style="list-style-type: none"> • Select the appropriate recording level.
Recording is not possible.	The recording level control of the cassette tape deck is at the "0" position. Erase-prevention tabs have been removed.	<ul style="list-style-type: none"> • Select the appropriate recording level. • Attach tape to cover space left by removal of erase-prevention tabs.
Tape moves but no sound is heard.	The volume control of the amplifier is set to its minimum position. The input selector of the amplifier is not set to the "tape" position.	<ul style="list-style-type: none"> • Adjust the volume control to the desired level. • Set it to the "tape" position.

During phono disc play		
A loud and unusual sound ("howling") is heard when the volume level is increased.	The location of the turntable and speaker systems is unstable.	<ul style="list-style-type: none"> • Try repositioning the speaker systems farther away from the turntable without directing them toward the turntable. • Try moving the turntable farther away from the speaker systems. • Try placing a cushioning material (such as felt or commercially available audio insulators) beneath the turntable and/or speaker systems.

Product Service

■ Warning concerning removal of covers

The unit should be serviced by qualified technicians only. No service information is provided for customers. Your product is designed and manufactured to ensure a minimum of maintenance. However, should your unit ever require service,

a nationwide system of factory servicenters and AUTHORIZED INDEPENDENT SERVICENTERS is maintained to support your product's warranty.

(In the U.S.A., call 1-800-447-4700 to locate the MSC Authorized Servicenter nearest you.)

Technical Specifications

Note:

Total harmonic distortion is measured by the digital spectrum analyzer (H.P. 3045 system).

DC Servo Automatic Turntable System

TURNTABLE SECTION

Type	Automatic turntable
Features	Auto-return, Auto-stop
Drive method	Belt drive
Motor	DC motor
Drive control method	DC servo control
Turntable platter	Aluminum die-cast Diameter 31.2 cm (12-9/32")
Turntable speeds	33-1/3 rpm and 45 rpm
Wow and flutter	0.045% WRMS (JIS C5521)
	±0.06% peak (IEC 98A weighted)
Rumble	70 dB (IEC 98A weighted)

TONEARM SECTION

Type	Static-balanced straight tonearm Plug-in connector cartridge system
Overhang	15 mm (19/32")
Effective length	230 mm (9-1/16")
Tracking error angle	Within 2° 32' at outer groove of 30 cm (12") disc Within 0° 32' at inner groove of 30 cm (12") disc

CARTRIDGE SECTION

Type	Moving magnet stereo cartridge Plug-in connector cartridge system
Frequency response	10 Hz to 30 kHz
Output voltage	2.5 mV at 1 kHz 5cm/s. zero to peak lateral velocity
Channel separation	22 dB at 1 kHz
Channel balance	Within 2 dB at 1 kHz
Compliance (dynamic)	12×10 ⁻⁶ cm/dyne at 100 Hz
Stylus pressure	1.25±0.25 g (12.5±2.5 mN)
Load impedance	47 kΩ to 100 kΩ
Weight	6 g (cartridge only)
Replacement stylus	EPS-24CS
Cartridge model number	EPC-P24S
Phono cable capacitance	90 pF

GENERAL

Power supply	AC 120V, 60 Hz
Power consumption	3W
Dimensions (W×H×D)	430 × 89 × 375 mm (16-15/16" × 3-1/2" × 14-3/4")
Weight	2.8 kg (6.2 lb)

Stereo Double Cassette Deck

Deck system	Stereo cassette deck
Track system	4-track, 2-channel
Heads	
(DECK A) REC/PLAY	Permalloy head
Erasing	Double-gap ferrite head
(DECK B) PLAY	Permalloy head
Motors	
(DECK A) Capstan/reel table drive	2 speed electronically controlled DC motor
(DECK B) Capstan/reel table drive	2 speed electronically controlled DC motor
Recording system	AC bias
Bias frequency	80 kHz
Erasing system	AC erase
Tape speed	4.8 cm/sec. (1-7/8 ips)
Frequency response (w/o Dolby N.R.)	
METAL	20 Hz~16 kHz (±15 dB) 40 Hz~15 kHz (±3 dB)
CrO ₂	20 Hz~15 kHz (±15 dB) 40 Hz~14 kHz (±3 dB)

Stereo Integrated Amplifier

Rated minimum sine wave

RMS power output
20 Hz~20 kHz both channels driven
0.05% total harmonic distortion
110W per channel (8 ohms)

1 kHz continuous power output both channels driven	115W per channel (8 ohms)
0.05% total harmonic distortion	
Dynamic headroom	1.1 dB (8 ohms)
Total harmonic distortion half power at 1 kHz	0.03% (8 ohms)
SMPTE intermodulation distortion	0.05% (8 ohms)

Frequency response	RIAA standard curve ±0.8 dB
PHONO	10 Hz~80 kHz, -3 dB
TUNER, CD, TAPE, VCR 2/TV, VCR 1/EQ	

Input sensitivity	
PHONO	0.4 mV (2.5 mV, IHF '66)
TUNER, CD, TAPE, VCR 2/TV, VCR 1/EQ	15 mV (150 mV, IHF '66)

S/N (IHF, A)	
PHONO	71 dB (73 dB, IHF '66)
TUNER, CD, TAPE, VCR 2/TV, VCR 1/EQ	75 dB (94 dB, IHF '66)

Maximum input voltage	
PHONO	128 mV (135 mV, 1 kHz)
Input impedance	
PHONO	47 kilohms
TUNER, CD, TAPE, VCR 2/TV, VCR 1/EQ	47 kilohms

Tone controls	
BASS	50 Hz, +10 dB~-10 dB
TREBLE	20 kHz, +10 dB~-10 dB
SUPER BASS	80 Hz, +6 dB
Output voltage TAPE REC OUT	150 mV
Load impedance	
MAIN or REMOTE	8~16 ohms
MAIN and REMOTE	8~16 ohms

GENERAL

Power consumption	360W, 470 VA
Power supply	AC 120V, 60 Hz
Dimensions (W×H×D)	430 × 119 × 255 mm (16-15/16" × 4-11/16" × 10-1/32")
Weight	7.2 kg (15.9 lb.)

Quartz Synthesizer AM/FM Stereo Tuner

FM TUNER SECTION

Frequency range	87.9~107.9 MHz (100 kHz step)
Sensitivity	10.8 dBf (0.95 μV/75Ω, IHF '58)
50 dB quieting sensitivity	
MONO	18.1 dBf (2.2 μV/75Ω, IHF '58)
STEREO	38.1 dBf (22 μV/75Ω, IHF '58)
Total harmonic distortion	
	0.2% (MONO), 0.3% (STEREO)
S/N	75 dB (MONO), 71 dB (STEREO)
Frequency response	20 Hz~15 kHz, +0.5 dB, -1.5 dB
Alternate channel selectivity ±400 kHz	65 dB
Stereo separation 1 kHz	40 dB
	30 dB
Carrier leak 19 kHz	-35 dB
	-50 dB
Antenna terminals	300 ohms (balanced) 75 ohms (unbalanced)

AM TUNER SECTION

Frequency range	530 kHz~1720 kHz (10 kHz step)
Sensitivity (S/N 20 dB)	20 μV, 300 μV/m
Selectivity (±10 kHz)	50 dB
Image rejection at 1000 kHz	40 dB
IF rejection at 1000 kHz	60 dB

GENERAL

Output voltage	0.6V
Power consumption	9W
Power supply	AC 120V, 60 Hz
Dimensions (W×H×D)	430 × 53 × 150 mm (16-15/16" × 2-3/32" × 5-28/32")
Weight	1.5 kg (3.3 lb.)

Hi-Fi Speaker Systems

(For SD-A840)

Type	3 way 3 sp. bass-reflex
Speakers	Woofer 30 cm (11-13/16") cone type Midrange 10 cm (3-15/16") cone type Tweeter 5.5 cm (2-5/32") cone type
Impedance	8Ω
Input level	Music 200W
Output sound pressure level	92 dB/W (1.0 m)
Frequency range	40 Hz~20 kHz (-10 dB) 30 Hz~22 kHz (-16 dB)
Dimensions (W×H×D)	450 × 950 × 277 mm (17-23/32" × 37-13/32" × 10-29/32")
Weight	20 kg (44.1 lb.)

(For SD-D740)

Only the following items are different from

SD-A840:	
Dimensions (W×H×D)	400 × 950 × 277 mm (15-3/4" × 37-13/32" × 10-29/32")
Weight	19 kg (41.9 lb.)

(For SD-A850/SD-A860/SD-A870)

Type	3 way 3 sp. bass-reflex
Speakers	Woofer 38 cm (14-31/32") cone type Midrange 10 cm (3-15/16") cone type Tweeter 5.5 cm (2-5/32") cone type
Impedance	8Ω
Input level	Music 200W
Output sound pressure level	92 dB/W (1.0 m)
Frequency range	40 Hz~20 kHz (-10 dB) 30 Hz~22 kHz (-16 dB)
Dimensions (W×H×D)	514 × 1000 × 325 mm (20-1/4" × 39-3/8" × 12-13/16")
Weight	22.5 kg (49.6 lb.)

(For SD-D750/SD-D760/SD-D770)

Only the following items are different from

SD-A850/SD-A860/SD-A870:	
Dimensions (W×H×D)	454 × 1000 × 325 mm (17-7/8" × 39-3/8" × 12-13/16")
Weight	21 kg (46.3 lb.)

Panasonic Company, Division of
Matsushita Electric Corporation of America
One Panasonic Way
Secaucus, New Jersey 07094

Matsushita Electric of Canada Limited
5770 Ambler Drive, Mississauga, Ontario L4W 2T3

Panasonic Hawaii, Inc.
91-238 Kauhū Street
Ewa Beach P.O. Box 774
Honolulu, Hawaii 96808-0774

Panasonic Sales Company,
Division of Matsushita Electric
of Puerto Rico, Inc. 
Ave 65 De Infanteria, KM 9.7
Victoria Industrial Park
Carolina, Puerto Rico 00630

Free Manuals Download Website

<http://myh66.com>

<http://usermanuals.us>

<http://www.somanuals.com>

<http://www.4manuals.cc>

<http://www.manual-lib.com>

<http://www.404manual.com>

<http://www.luxmanual.com>

<http://aubethermostatmanual.com>

Golf course search by state

<http://golfingnear.com>

Email search by domain

<http://emailbydomain.com>

Auto manuals search

<http://auto.somanuals.com>

TV manuals search

<http://tv.somanuals.com>