

# Technics

Stereo Integrated Amplifier

SU-V500

SU-V300

Operating Instructions

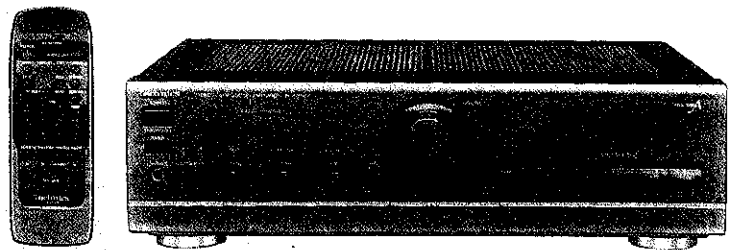

The photograph shows the SU-V500 model.

The configuration of the ventilation holes differs according to area.

**Note:**

The "EB" indication shown on the packing case indicates United Kingdom.

Before operating this unit, please read these instructions completely.

E EB EO GC GN

RQT2378-B

# Dear Customer



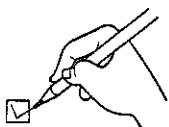

Thank you for purchasing this Technics product.  
For optimum performance and safety, please read these instructions carefully.

These operating instructions are applicable to the SU-V500 and SU-V300 models.

These operating instructions, however, fundamentally explain the operation of SU-V500 model.

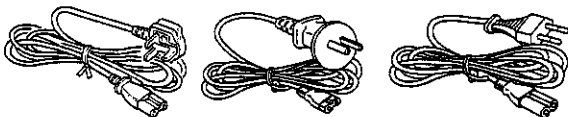

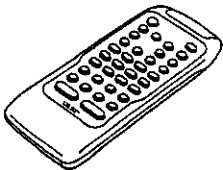
Please check and identify the supplied accessories

<input type="checkbox"/>	AC power supply cord ..... 1 (For United Kingdom) (For Australia and N.Z.) (For others)
	
<input type="checkbox"/>	Power plug adaptor (SJP5213-2) ..... 1 (Not supplied for United Kingdom, Europe, Australia and N.Z.)
	
<input type="checkbox"/>	Remote control transmitter (RAK-SU129WH) ..... 1 <b>SU-V500 only</b>
	
<input type="checkbox"/>	Batteries (UM-4, "AAA", R03) ..... 2 <b>SU-V500 only</b>
	

(For areas except United Kingdom, Europe, Australia and N.Z.)

## CAUTION:

The AC voltage is different according to the area.

Be sure to set the proper voltage in your area before use.

(For details, please refer to the page 7.)

# Contents

<b>Caution for AC mains lead</b> (For United Kingdom) .....	<b>3</b>
<b>Suggestions for safety</b> .....	<b>4</b>
<b>Front panel controls</b> .....	<b>5</b>
<b>Connections</b> .....	<b>6</b>
<b>Listening to Sound</b> .....	<b>8</b>
To adjust the tone quality .....	9
To adjust the sound balance .....	9
When listening through headphones .....	9
<b>Recording</b> .....	<b>10</b>
To record from compact discs, etc. ....	10
Tape-to-tape recording .....	10
<b>Technical specifications</b> .....	<b>11</b>
<b>Troubleshooting guide</b> .....	<b>Back cover</b>

# Caution for AC mains lead

## (For United Kingdom)

("EB" area code model only)

For your safety, please read the following text carefully.

This appliance is supplied with a moulded three pin mains plug for your safety and convenience.

A 5-ampere fuse is fitted in this plug.

Should the fuse need to be replaced please ensure that the replacement fuse has a rating of 5-ampere and that it is approved by ASTA or BSI to BS1362.

Check for the ASTA mark  or the BSI mark  on the body of the fuse.

If the plug contains a removable fuse cover you must ensure that it is refitted when the fuse is replaced.

If you lose the fuse cover the plug must not be used until a replacement cover is obtained.

A replacement fuse cover can be purchased from your local dealer.

### CAUTION!

IF THE FITTED MOULDED PLUG IS UNSUITABLE FOR THE SOCKET OUTLET IN YOUR HOME THEN THE FUSE SHOULD BE REMOVED AND THE PLUG CUT OFF AND DISPOSED OF SAFELY.

THERE IS A DANGER OF SEVERE ELECTRICAL SHOCK IF THE CUT OFF PLUG IS INSERTED INTO ANY 13-AMPERE SOCKET.

If a new plug is to be fitted please observe the wiring code as shown below.

If in any doubt please consult a qualified electrician.

### IMPORTANT

The wires in this mains lead are coloured in accordance with the following code:

Blue: Neutral

Brown: Live

As the colours of the wires in the mains lead of this appliance may not correspond with the coloured markings identifying the terminals in your plug, proceed as follows:

The wire which is coloured BLUE must be connected to the terminal in the plug which is marked with the letter N or coloured BLACK.

The wire which is coloured BROWN must be connected to the terminal in the plug which is marked with the letter L or coloured RED.

Under no circumstances should either of these wires be connected to the earth terminal of the three pin plug, marked with the letter E or the Earth Symbol .

### Before use

Remove the connector cover as follows.

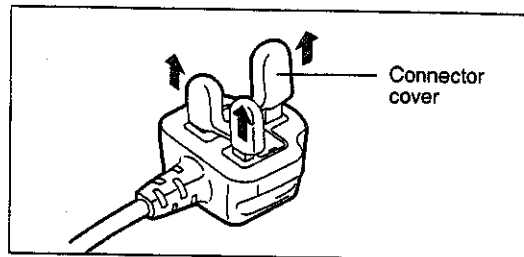

### How to replace the fuse

1. Remove the fuse cover with a screwdriver.

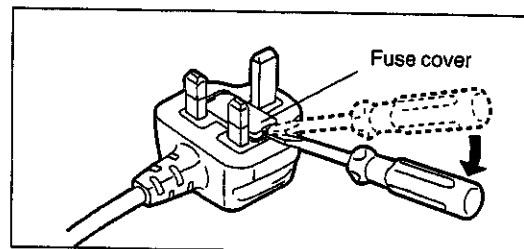

2. Replace the fuse and attach the fuse cover.

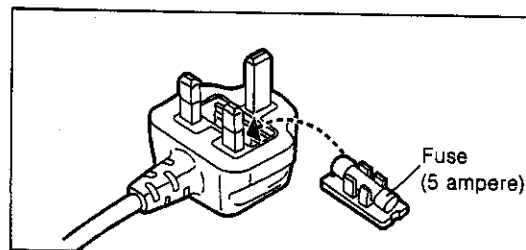

# Suggestions for safety

---

## Placement

---

Avoid placing the unit in areas of:

- direct sunlight
- high temperature
- high humidity
- excessive vibration
- uneven surfaces. (Place the unit on a flat level surface).

Such conditions might damage the cabinet and/or other component parts and thereby shorten the unit's service life.

---

## Ventilation

---

- Place the unit in a well ventilated position at least 10 cms away from wall surfaces etc.
- Ensure that curtains and similar materials do not obstruct the ventilation holes.

---

## Stacking

---

Never place heavy items on top of the unit or the power cord.

---

## Voltage

---

- It is very dangerous to use an AC power source of high voltage such as for an air conditioner.  
A fire might be caused by such a connection.
- A DC power source can not be used.  
Be sure to check the power source carefully, especially on a ship or other place where DC is used.

---

## Power cord protection

---

- Avoid cuts, scratches or poor connection of the AC mains cord, as this may result in fire or electric shock hazard.  
Excessive bending, pulling or slicing of the cord should also be avoided.
- Do not pull on the cord when you are disconnecting the power, as this could cause an electric shock. Grasp the plug firmly when you disconnect the power supply.
- Never touch the plug with wet hands or a serious electric shock could result.

---

## Foreign materials

---

- Ensure that no foreign objects, such as needles, coins, screwdrivers etc, accidentally fall into the unit or through the ventilation holes.  
Otherwise, a serious electric shock or malfunction could occur.
- Be extremely careful about spilling water or liquid on/into the unit, as a fire or electric shock could occur.  
(Disconnect the power plug and contact your dealer immediately if this occurs.)
- Avoid spraying insecticides onto the unit as they contain flammable gases which can be ignited.
- Insecticides, alcohol, paint thinner and similar chemicals should never be used to clean the unit as they can cause flaking or cloudiness to the cabinet finish.

---

## Maintenance

---

Clean the cabinet, panel and controls with a soft cloth lightly moistened with mild detergent solution.

Do not use any type of abrasive pad, scouring powder or solvent such as alcohol or benzene.

---

## Service

---

- Never attempt to repair, disassemble or reconstruct the unit if there seems to be a problem.  
A serious electric shock could result if you ignore this precautionary measure.
- If a problem occurs during operation (the sound is interrupted, indicators fail to illuminate, smoke is detected, etc) contact your dealer or Authorised Service Center immediately.
- Disconnect the power supply if the unit will not be used for a long time. Otherwise the operation life could be shortened.

# Front panel controls

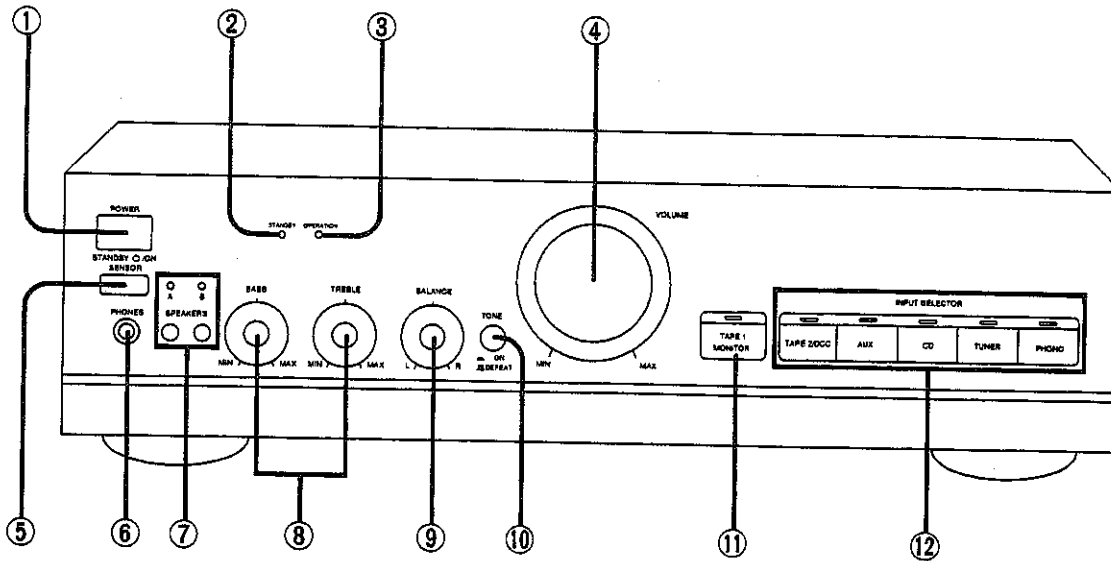

No.	Name	Ref. page
①	<b>Power "STANDBY <math>\phi</math>/ON" switch (POWER, STANDBY <math>\phi</math>/ON)</b>	8
	Press to switch the unit from on to standby mode or vice versa. In standby mode, the unit is still consuming a small amount of power.	
②	<b>"STANDBY" Indicator (STANDBY)</b>	—
	When the unit is connected to the AC mains supply, this indicator lights up in standby mode and goes out when the unit is turned on.	
③	<b>Operation indicator (OPERATION)</b>	—
	When the power is switched ON, this indicator illuminates after about 2 seconds when the unit is in the operating condition. If an abnormal condition in the circuitry is detected, such as a short-circuit of the positive (+) and negative (-) wires from the speaker terminals, the protection circuit functions and this indicator will not illuminate.	
④	<b>Volume control (VOLUME)</b>	8
⑤	<b>SU-V500 only</b> <b>Remote control signal receptor (SENSOR)</b>	—
	Receives the signals from the remote control.	
⑥	<b>Headphones Jack (PHONES)</b>	9

No.	Name	Ref. page
⑦	<b>Speaker select buttons/indicators (SPEAKERS)</b>	8
⑧	<b>Tone controls (BASS/TREBLE)</b>	9
⑨	<b>Balance control (BALANCE)</b>	9
⑩	<b>Tone control button (TONE)</b>	9
⑪	<b>TAPE 1 MONITOR button/indicator (TAPE 1 MONITOR)</b>	8,10
⑫	<b>Input select buttons/indicators (INPUT SELECTOR)</b>	8,10

# Connections

## To connect to each terminal

Make connections to each component in the system by using stereo connection cables (not included).

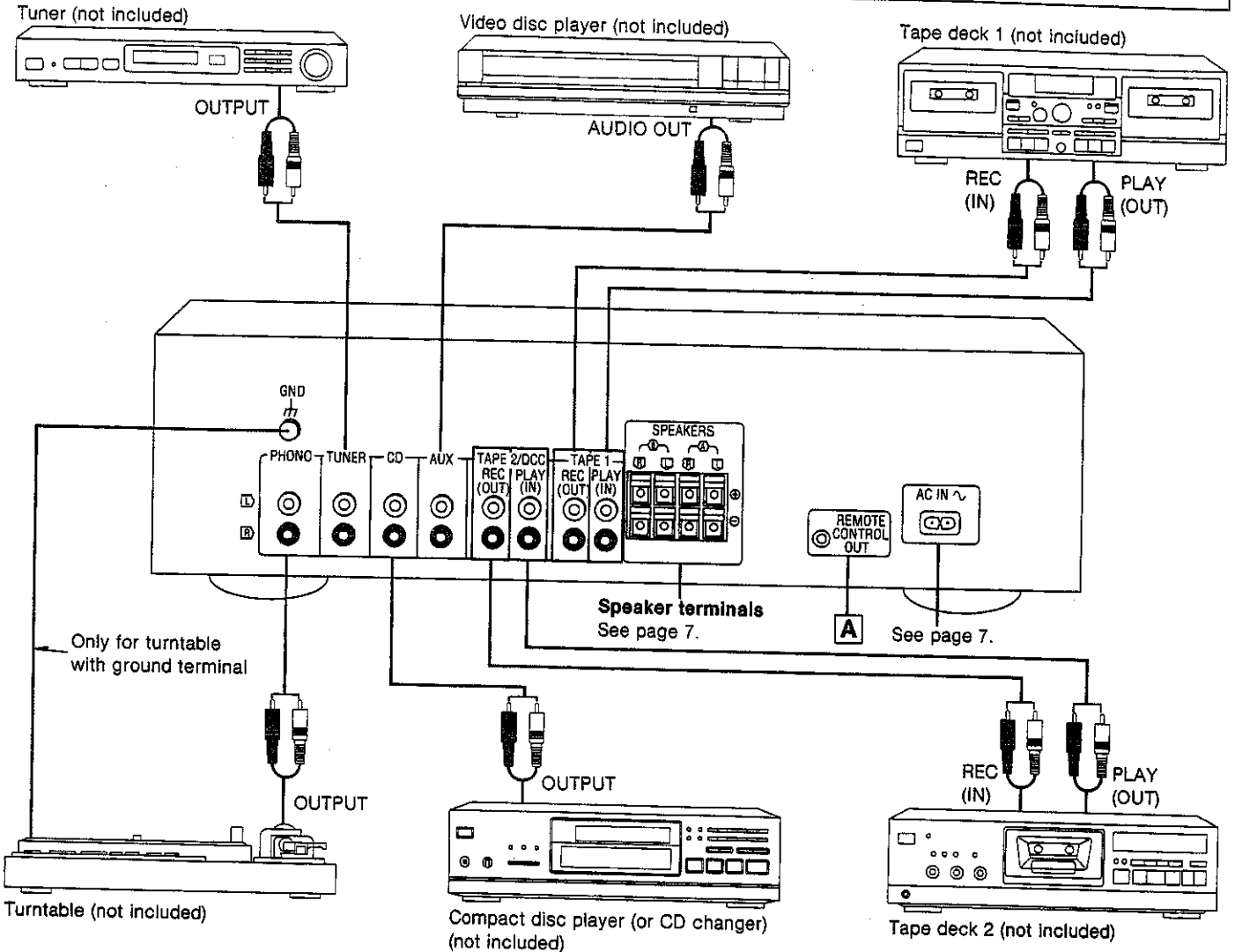
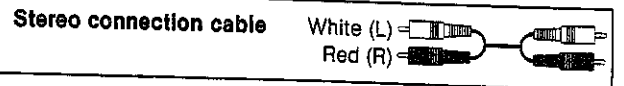

### A "REMOTE CONTROL OUT" terminal

**SU-V500 only**

Connect the connection cable for the remote control to a Technics tape deck and/or CD player (or CD changer) which has the appropriate remote control terminal as shown at the right.

If a tape deck is not being used, the CD player (or CD changer) can be connected directly (dotted line).

#### Note

For a tape deck and/or CD player (or CD changer) with a remote control sensor, this connection is not necessary.

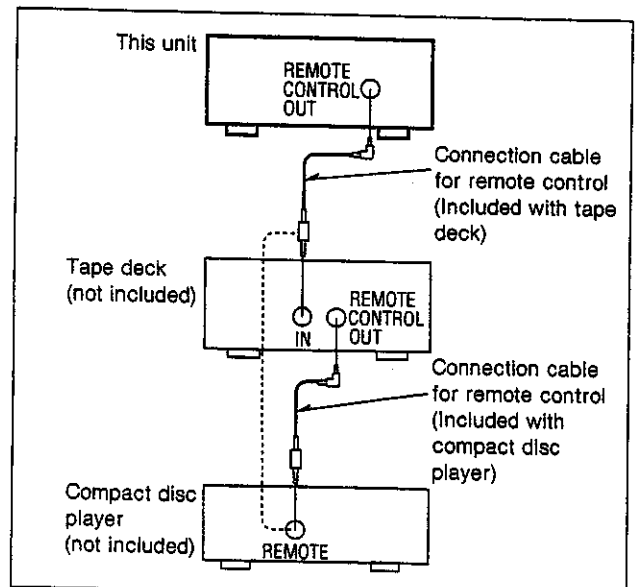

## To connect the speakers

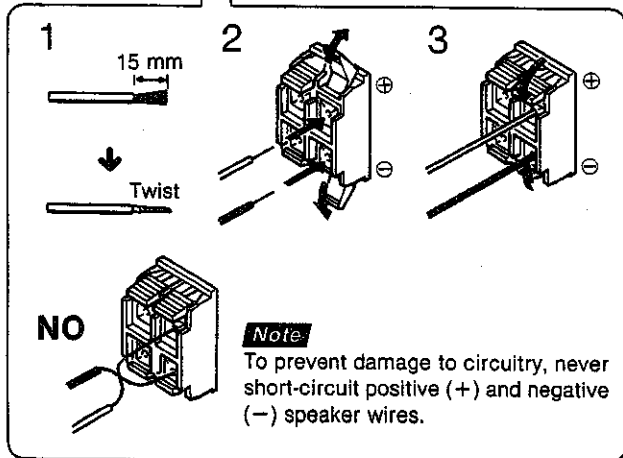
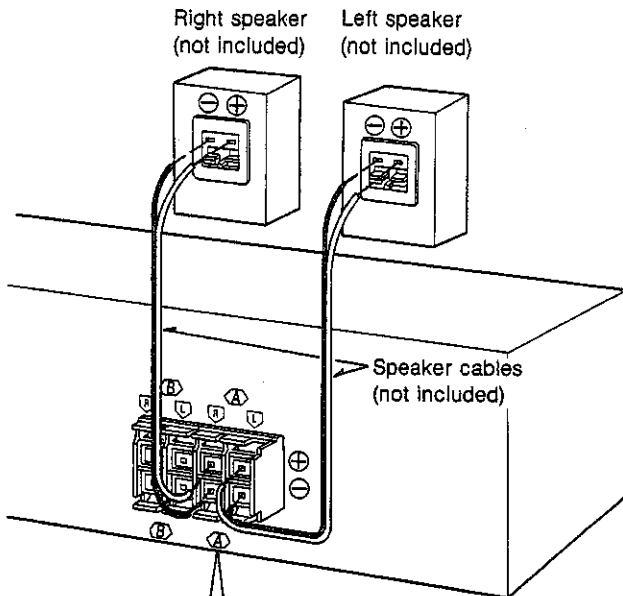

### ■ "B" terminals

For connection to a second pair of speakers.

### ■ Speaker impedance

- When only the "A" or only the "B" terminals are used: 4–16 ohms
- When both the "A" and the "B" terminals are used simultaneously: 8–16 ohms

## About the cooling fan

The cooling fan operates at high power output levels only. (There is no cooling fan for some countries.)

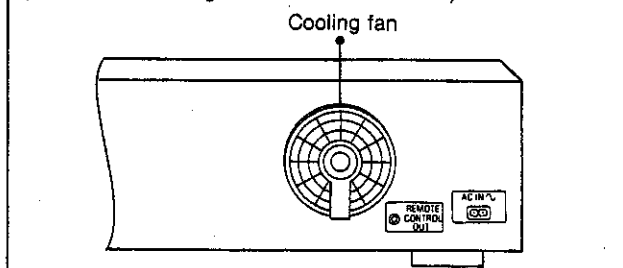

## To connect the AC power supply cord

**FOR UNITED KINGDOM ONLY**  
BE SURE TO READ THE CAUTION FOR THE AC POWER SUPPLY CORD ON PAGE 3 BEFORE CONNECTING THE AC POWER SUPPLY CORD.

**For areas except United Kingdom, Europe, Australia and N.Z. [SU-V500 only]**

Be sure to set the voltage selector to "110 V–127 V" or "220 V–240 V" according to the area in which the unit will be used.

[Use a minus (-) screwdriver]

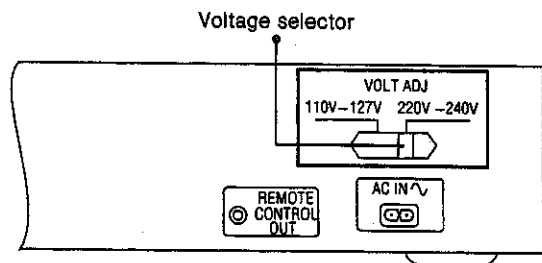

### **Note**

Note that this unit will be seriously damaged if this setting is not made correctly.

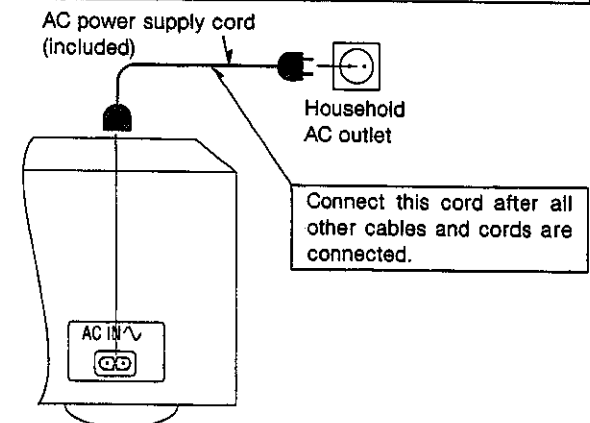

**(For areas except Australia and N.Z.)**

### Insertion of Connector

Even when the connector is perfectly inserted, depending on the type of inlet used, the front part of the connector may jut out as shown in the drawing. However there is no problem using the unit.

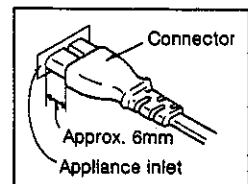

### **Note**

The configuration of the AC power supply cord differs according to area.

**Not supplied for United Kingdom, Europe, Australia and N.Z.**

If the power plug will not fit your socket, use the power plug adaptor (included).



# Listening to Sound

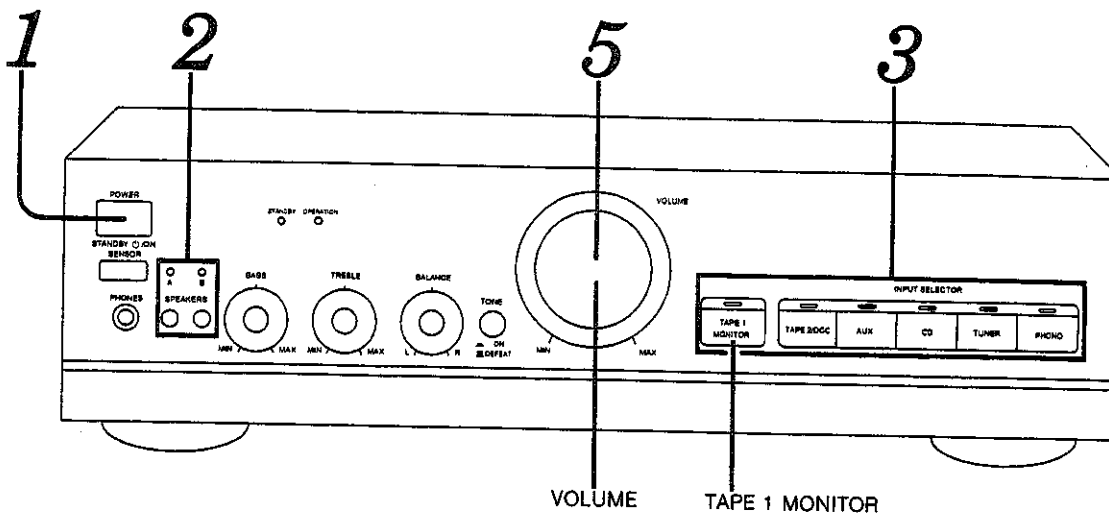

Before operation, set VOLUME to the "MIN" position.

**1** **POWER** Press **POWER** to switch on the power.

**3** Press to select the desired source.

**2** Press **A** and/or **B** to select the speaker system(s) to be used.

A and B refer to the speaker terminals at the rear of the unit.

The corresponding indicator above will illuminate to indicate which button is selected.

**TAPE 1 MONITOR:** To listen to tape (TAPE 1). The tape monitor indicator will illuminate. (See below.)

**TAPE 2/DCC:** To listen to tape (TAPE 2) or digital compact cassette (DCC).

**AUX:** To listen to equipment connected to the "AUX" terminals.

**CD:** To listen to compact discs.

**TUNER:** To listen to radio broadcasts.

**PHONO:** To listen to phono discs.

The corresponding indicator above will illuminate to indicate which speaker system is selected.

**A:** Sound can be heard from the speakers connected to the "A" terminals.

**B:** Sound can be heard from the speakers connected to the "B" terminals.

**A and B:** Sound can be heard simultaneously from the speakers connected to the "A" terminals and the "B" terminals.

**off:** No sound will be heard from the speakers. (Both indicators will turn off.)

**4** Start the desired source. (Refer to the appropriate operating instructions for details.)

**5** Turn **VOLUME** to adjust the volume level.

**After listening is finished**  
Be sure to reduce the volume level, and turn the unit off by pressing **POWER**.

## When tape 1 monitor indicator illuminates

Illuminates This indicates that the tape monitor function of this unit is ON.  
To listen to sources other than a tape (TAPE 1), be sure to turn off the indicator by pressing **TAPE 1 MONITOR**.





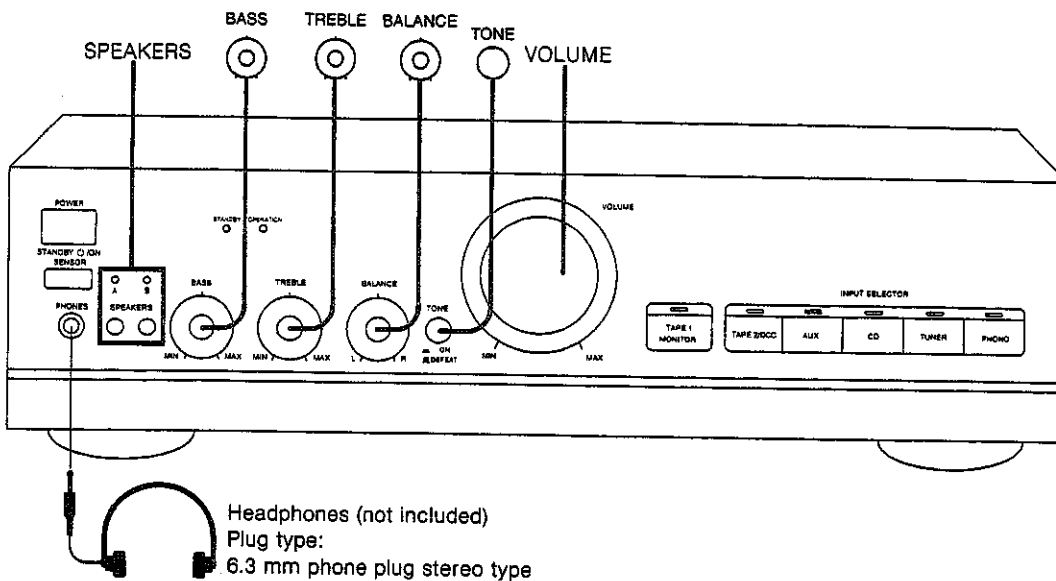

### To adjust the tone quality



**Set TONE to the "ON" position.**  
If set to the "DEFEAT" position, tone controls have no effect.

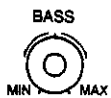
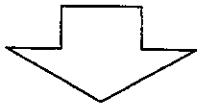

**Turn BASS to adjust the low-frequency sound.**

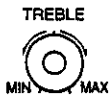

**Turn TREBLE to adjust the high-frequency sound.**

### To adjust the sound balance



**Turn BALANCE to adjust the left/right sound balance.**

### When listening through headphones

**Use VOLUME to reduce the volume level, and connect the headphones.**

If sound from speakers is not wanted, press SPEAKERS (A) and/or (B) to turn off the speaker select indicators.

**Note**

Avoid listening for prolonged periods of time to prevent hearing damage.

# Recording

## To record from compact discs, etc.

It is possible to record from units which are connected to the rear "AUX", "CD", "TUNER" or "PHONO" terminals to cassette tape decks or DCC decks which are connected to the "TAPE 1" or "TAPE 2/DCC" terminals.

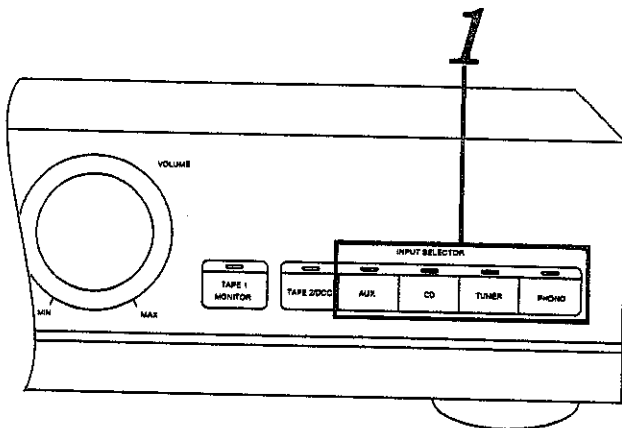

Before recording, prepare the tape deck or DCC for recording (recording level adjustment, etc.). See the tape deck's or DCC's operating instructions for details.

**1**

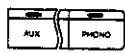

**Select the program source to be recorded.**

- AUX:** To record from equipment connected to the "AUX" terminals.  
**CD:** To record from compact discs.  
**TUNER:** To record from radio broadcasts.  
**PHONO:** To record from phono discs.

**2**

**Begin recording.**

Follow your tape deck's or DCC's operating instructions.

**3**

**Begin the source to be recorded.**

### Note

If recording to both decks simultaneously, do not press TAPE 1 MONITOR. (If this button is pressed, it will not be possible to record to the deck which is connected to the "TAPE 2/DCC" terminals.)

## To check the sound recorded while recording is being made

If a cassette tape deck with 3 heads is connected to the "TAPE 1" terminals, it is possible to check the sound being recorded on to the tape.

## Tape-to-tape recording

It is possible to record from tape deck 2 (the cassette tape deck or DCC deck which is connected to the "TAPE 2/DCC" terminals) to tape deck 1 (the cassette tape deck which is connected to the "TAPE 1" terminals).

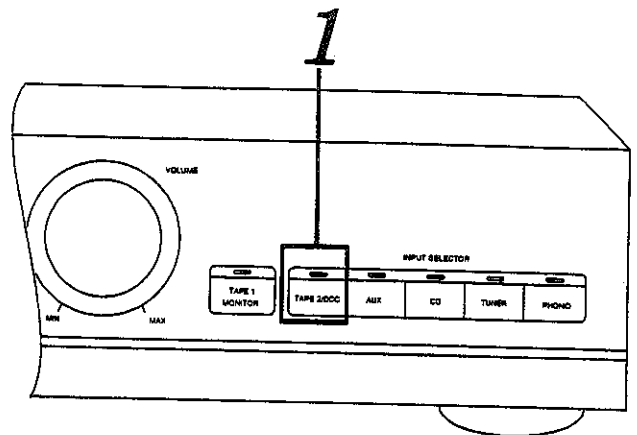

### Preparation

- Before recording, prepare the tape deck for recording (recording level adjustment, etc.). See the tape deck's operating instructions for details.
- Load tapes which have been advanced to the end of the leader tape into both decks.

**Tape deck 1:** For recording    **Tape deck 2:** For playback.

**1**



**Press TAPE 2/DCC.**

**2**

**Begin recording on tape deck 1.**

Follow your tape deck's operating instructions.

**3**

**Begin tape playback on tape deck 2.**

### For your reference

When recording from tape deck 1 to tape deck 2, press TAPE 1 MONITOR in step 1 above, and then start recording on tape 2 and begin playback on tape 1.

At this time, make sure that the input selector is set to a position other than "TAPE 2/DCC". (This is because monitoring of the unit connected to the "TAPE 2/DCC" terminals is not possible.)



Press TAPE 1 MONITOR (indicator will illuminate,) on this unit and set the monitor button on the tape deck to "TAPE".



Press TAPE 1 MONITOR once again to turn it off.

# Technical specifications (DIN 45 500)

<b>20 Hz–20 kHz continuous power output</b> both channels driven [SU-V500] (For United Kingdom, Europe, Australia and N.Z.)	2 × 30 W (8 Ω)
<b>40 Hz–20 kHz continuous power output</b> both channels driven [SU-V500] (For areas except United Kingdom, Europe, Australia and N.Z.)/[SU-V300]	2 × 27 W (8 Ω)
<b>1 kHz continuous power output</b> both channels driven (THD: 1%) [SU-V500] (For United Kingdom, Europe, Australia and N.Z.)	2 × 38 W (8 Ω) 2 × 50 W (4 Ω)
[SU-V500] (For areas except United Kingdom, Europe, Australia and N.Z.)/[SU-V300]	2 × 33 W (8 Ω) 2 × 40 W (4 Ω)
<b>63 Hz–12.5 kHz continuous power output</b> both channels driven (THD: 1%) [SU-V500] (For United Kingdom, Europe, Australia and N.Z.)	2 × 35 W (8 Ω) 2 × 45 W (4 Ω)
[SU-V500] (For areas except United Kingdom, Europe, Australia and N.Z.)/[SU-V300]	2 × 30 W (8 Ω) 2 × 35 W (4 Ω)
<b>Total harmonic distortion</b> rated power at 20 Hz–20 kHz	0.1% (8 Ω)
<b>Intermodulation distortion (50 Hz: 7 kHz = 4:1, SMPTE)</b> rated power	0.1% (8 Ω)
<b>Residual hum and noise</b>	1 mV
<b>Damping factor</b>	60 (8 Ω) 30 (4 Ω)
<b>Headphones output level/impedance</b>	340 mV/47 Ω
<b>Load impedance</b> A or B A and B	4–16 Ω 8–16 Ω
<b>Input sensitivity/impedance</b> PHONO MM TUNER, CD, AUX, TAPE 1, TAPE 2/DCC	2.5 mV/47 kΩ 150 mV/22 kΩ
<b>Phono maximum input voltage (1 kHz, RMS)</b> MM	150 mV (IHF '66)
<b>S/N (rated power, 4 Ω)</b> PHONO MM [SU-V500] (For United Kingdom, Europe, Australia and N.Z.) [SU-V500] (For areas except United Kingdom, Europe, Australia and N.Z.)/[SU-V300]	76 dB (77 dB, IHF '66) 76 dB (76 dB, IHF '66)
<b>TUNER, CD, AUX, TAPE 1, TAPE 2/DCC</b> [SU-V500] (For United Kingdom, Europe, Australia and N.Z.) [SU-V500] (For areas except United Kingdom, Europe, Australia and N.Z.)/[SU-V300]	90 dB (95 dB, IHF '66) 90 dB (94 dB, IHF '66)
<b>S/N at –26 dB power (4 Ω)</b> PHONO MM TUNER, CD, AUX, TAPE 1, TAPE 2/DCC	67 dB 70 dB
<b>S/N at 50 mW power (4 Ω)</b> PHONO MM TUNER, CD, AUX, TAPE 1, TAPE 2/DCC	63 dB 63 dB

## Frequency response

PHONO MM RIAA standard curve ±1 dB  
(30 Hz–15 kHz)

## TUNER, CD, AUX, TAPE 1, TAPE 2/DCC

3 Hz–80 kHz (+0, –3 dB)  
+0 dB, –0.3 dB (20 Hz–20 kHz)

## Tone controls

BASS 50 Hz, +10 to –10 dB  
TREBLE 20 kHz, +10 to –10 dB

## Output voltage

TAPE 1, TAPE 2/DCC REC OUT 150 mV  
Channel balance (AUX 250 Hz–6.3 kHz) ±1 dB  
Channel separation (AUX 1 kHz) 50 dB

## ■ GENERAL

**Power consumption** [SU-V500] 130 W  
[SU-V300] 110 W

## Power supply

For Europe 50 Hz/60 Hz AC, 230 V  
For United Kingdom, Australia and N.Z.

50 Hz/60 Hz AC, 230 V–240 V  
For others 50 Hz/60 Hz AC, 110 V–127 V/220 V–240 V

## Dimensions (W × H × D)

430 × 125 × 310 mm

## Weight

[SU-V500] (For United Kingdom, Europe, Australia and N.Z.) 6.0 kg

[SU-V500] (For areas except United Kingdom, Europe, Australia and N.Z.)/[SU-V300] 5.4 kg

## Notes:

- Specifications are subject to change without notice. Weight and dimensions are approximate.
- Total harmonic distortion is measured by the digital spectrum analyzer.
- For areas except Europe**  
The specification values given have been measured while using a 240 V power supply.

## For United Kingdom only

This apparatus was produced to BS 800.

# Troubleshooting Guide

Before requesting service for this unit, check the chart below for a possible cause of the problem you are experiencing. Some simple checks or a minor adjustment on your part may eliminate the problem and restore proper operation. If you are in doubt about some of the check points, or if the remedies indicated in the chart do not solve the problem, refer to the directory of Authorized Service Centers (enclosed with this unit) to locate a convenient service center, or consult your Technics dealer for instructions.

Problem	Probable cause(s)	Suggested remedy
<b>Problems noted at all times</b>		
<b>No sound is heard when the power is switched ON.</b>	The power cord plug is not completely inserted.	• Confirm that the power cord plug is connected completely.
	Connections to the speakers, etc. are incomplete or incorrect.	• Check to be sure that all connection wires are correctly connected.
	The input selector setting is incorrect.	• Check to be sure that the selection of the desired sound source is made correctly.
	The speaker selector is set incorrectly.	• Set it to the correct position.
<b>When listening to stereo sound, the sound lacks depth (i.e. thin bass, tinny sound).</b>	The tape monitor function is on. (TAPE 1 MONITOR indicator is illuminated)	• When listening to a source other than the tape deck (TAPE 1), press TAPE 1 MONITOR so that the indicator is switched off.
	One of the speakers is connected out of phase [(+)→(-), (-)→(+)].	• Reconnect the speakers maintaining proper polarity [i.e., (+)→(+), (-)→(-)].
<b>When listening to stereo sound, the left and right sounds are reversed.</b>	The left and right speaker connections, source connections, or graphic equalizer connections are reversed.	• Check all connections and correct them if necessary.
<b>A low-pitched noise ("hum" or "buzz") is heard.</b>	The power cord or a fluorescent light, etc., is near the connection wires.	• Try separating this unit as far as possible from the electric appliance.
<b>Sound is not heard from one of the speakers.</b>	The speaker wires are disconnected.	• Check and correct the connections of the speaker wires.
	The balance control is set too far to one side.	• Set so that sounds are heard at the center, between the speakers.
<b>Sound stops during a performance, or no sound is heard when the power is switched ON.</b>	The protection circuitry has functioned because the positive and negative speaker connection wires are "shorted", speakers with an impedance less than the indicated rated impedance of the amplifier are used.	• Switch OFF the power, and, after determining and correcting the cause, switch ON the power once again. • Use the speakers of the proper impedance rating.

**Matsushita Electric Industrial Co., Ltd.**  
Central P.O. Box 288, Osaka 530-91, Japan

# Technics

## How to use the remote control transmitter RAK-SU129WH



### Before use

#### Battery installation

Insert the batteries included with this unit as shown below.

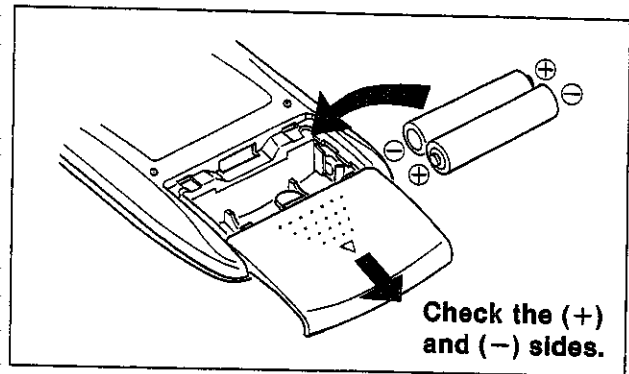

#### When you need to replace these batteries

Use two UM-4 "AAA", IEC R03 (1.5 V) or equivalent batteries.

#### Method for use

Use the remote control within 60 degrees and within 7 meters (23 ft.) facing directly toward the amplifier's remote control signal sensor.

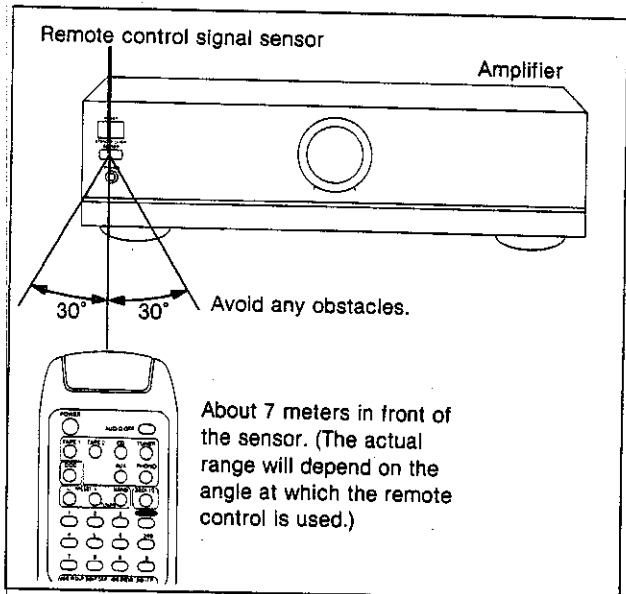

#### Note

Be sure the transmission window and the unit's sensor are free from dust. Excessive dust might affect performance.

The operation may not be correct if direct sunlight or another strong light source strikes the receiving sensor of this unit. If there is a problem, place the unit away from the light source.

When operating a Technics audio equipment with a remote control sensor, face this remote control toward the remote control sensor of the unit to be operated.

# Remote control operation

This remote control transmitter can be used to operate other units manufactured by Technics in addition to this amplifier, including CD players (or CD changers), cassette decks, DCC decks, or tuners.

- For detailed information concerning operation steps, etc., please refer to the appropriate page for each unit and the respective operating instructions.
- Make sure that the power of each unit is set to the "ON" position before beginning the operations.

## NOTE:

Face this remote control transmitter toward the main unit to operate the main unit or other units which are connected to the main unit by means of a remote control cable. To operate any other unit with a remote control sensor, face this remote control transmitter toward that unit.

## To operate the amplifier

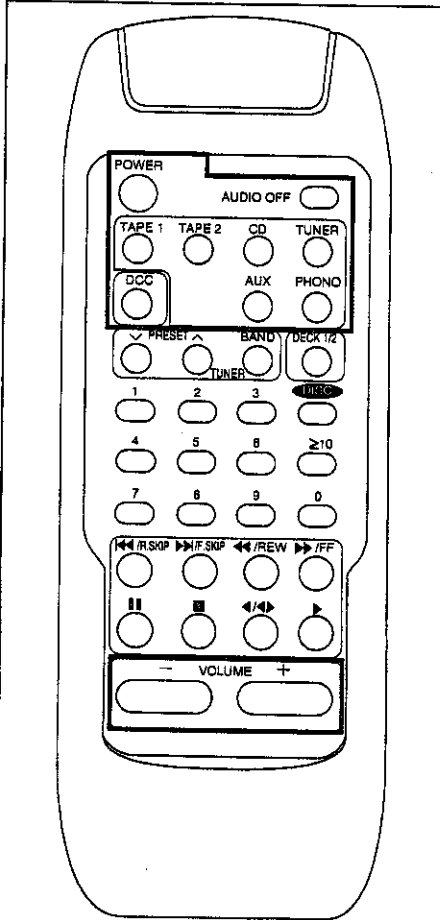
	<b>To turn the unit ON/OFF</b>	POWER <input type="radio"/>
	<b>To change the input source</b>	TAPE 1   TAPE 2   CD   TUNER <input type="radio"/> <input type="radio"/> <input type="radio"/> <input type="radio"/> DCC   AUX   PHONO <input type="radio"/> <input type="radio"/> <input type="radio"/> <p>The input source on the amplifier will change each time a button is pressed.                  Furthermore, if either TAPE 2 or DCC is pressed, only the "TAPE 2/DCC" input indicator will illuminate in both cases.  <b>Only for SU-V500</b>                  The tape monitoring function of the amplifier will switch on when TAPE 1 is pressed.                  The monitoring function will then be automatically canceled when a button other than TAPE 1 is pressed.</p>
	<b>To adjust the volume level</b>	-   VOLUME   + <input type="text"/> <input type="text"/>
	<b>If your unit is equipped with the New Technics Remote Control System (see below)</b>	
	<b>To turn the system OFF</b>	AUDIO OFF <input type="radio"/>

**New Technics Remote Control System Compatibility Table** (as of April, 1994)

<b>Amplifier</b>	SU-V500, SU-A700MK2, SU-A800MK2, SU-A900MK2
<b>CD player (or CD changer)</b>	SL-PG380A, SL-PG460A, SL-PG560A, SL-PD667, SL-PD867, SL-PD1000
<b>Cassette deck</b>	RS-BX501, RS-BX601, RS-BX701, RS-BX646, RS-BX747, RS-TR373, RS-TR474, RS-TR575
<b>Digital compact cassette deck (DCC)</b>	RS-DC8
<b>Tuner</b>	ST-GT350, ST-GT550, ST-GT650

## Remote control operation

### To operate a digital compact cassette deck (DCC)

The explanation below is an example of operation in the case where a DCC been connected to the "TAPE 2/DCC" terminals on the rear of this amplifier.

**Note:** The Technics RS-DC10 can not be operated by this remote control.

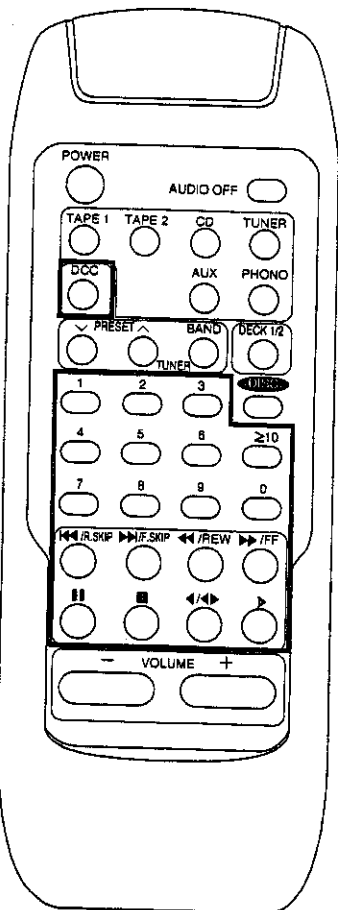

**To switch the remote control transmitter to DCC operation mode**



The input source for the amplifier will switch to the DCC deck which is connected to the "TAPE 2/DCC" terminals, and operation of the buttons listed below will be possible.

**If a DCC deck which is equipped with the New Technics Remote Control System is connected**

The power supply of the DCC deck can be turned on by pressing this button for approximately 2 seconds.

**To start play**



**To select by track number**

This is only effective for commercially-available DCC tapes and for other DCC tapes for recording purposes which have had track numbers recorded.

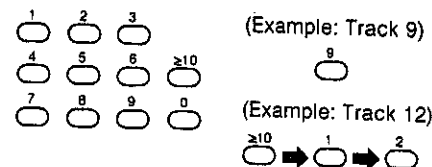

After the desired track has been searched for, the unit will return to the condition before the button was pressed (playing back, stopped or paused).

**To change the tape side**



**To fast-forward or rewind the tape**

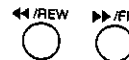

(Backward) (Forward)

**To skip a track**



(Backward) (Forward)

**To stop play temporarily**



Press  to resume play.

**To stop play**







## Free Manuals Download Website

<http://myh66.com>

<http://usermanuals.us>

<http://www.somanuals.com>

<http://www.4manuals.cc>

<http://www.manual-lib.com>

<http://www.404manual.com>

<http://www.luxmanual.com>

<http://aubethermostatmanual.com>

Golf course search by state

<http://golfingnear.com>

Email search by domain

<http://emailbydomain.com>

Auto manuals search

<http://auto.somanuals.com>

TV manuals search

<http://tv.somanuals.com>