

# Technics®

## AV Control Receiver

### Operating Instructions

Model No. **SA-DX750**



Before connecting, operating or adjusting this product, please read these instructions completely.  
Please keep this manual for future reference.

P PC

RQT5728-1P

## Dear customer

Thank you for purchasing this product.  
For optimum performance and safety, please read these instructions carefully.

### Supplied accessories

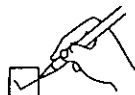

Please check and identify the supplied accessories.

AC power supply cord (RJA0065-A) .....1

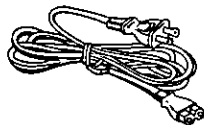

AM loop antenna set (RSA0012) .....1  
(AM loop antenna, antenna holder, screw)

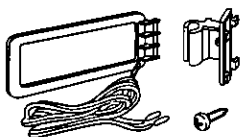

FM indoor antenna (RSA0006) .....1



Batteries .....2

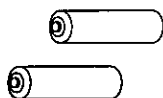

Remote control (EUR7702020) .....1



Refer to the separate booklet, "Remote Control", for remote control operation details.

Use the numbers indicated in parentheses when asking for replacement parts.

*(Only for U.S.A.)*

To order accessories contact 1-800-332-5368 or web site (<http://www.panasonic.com>).

User memo:

DATE OF PURCHASE \_\_\_\_\_

DEALER NAME \_\_\_\_\_

DEALER ADDRESS \_\_\_\_\_

TELEPHONE NUMBER \_\_\_\_\_

The model number and serial number of this product can be found on either the back or the bottom of the unit. Please note them in the space provided below and keep for future reference.

MODEL NUMBER \_\_\_\_\_ SA-DX750

SERIAL NUMBER \_\_\_\_\_

## Table of contents

### Before use

Listening caution.....	3
PRECAUTIONS.....	4
Control reference guide.....	5

### Connections

Connections.....	6
Connecting video equipment.....	6
Connecting audio equipment.....	7
Connecting digital equipment.....	7
Antenna connections.....	8
Connecting the AC power supply cord and other information.....	9
Speaker connections.....	10
Placement of speakers.....	10
Connecting speakers.....	10

### Preparations

Customizing your receiver.....	12
Basic steps.....	13
Adjusting speaker output level.....	14

### Operations

DSP sound modes.....	15
STEREO mode.....	15
SURROUND mode.....	15
SFC modes.....	16
Enjoying the sounds.....	17
Adjusting the tone and balance.....	18
Using headphones.....	18
Muting the volume.....	19
Adjusting the subwoofer level.....	19
Using the TAPE MONITOR.....	19

### Radio functions

The radio.....	20
Manual tuning.....	20
Preset tuning.....	21

### Reference

Making a recording.....	22
The HELP function.....	22
Specifications.....	23
Maintenance.....	23
Product Service.....	23
Troubleshooting guide.....	24
Servicenter List (U.S.A.).....	25
Warranty (U.S.A.).....	26

### CAUTION

Do not place anything on top of this unit or block the heat radiation vents in any way. In particular, do not place tape decks or CD/DVD players on this unit as heat radiated from it can damage your software.

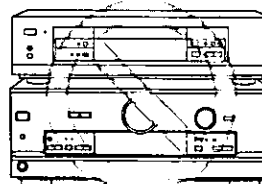

**NO**

## Enjoying surround sound

Pages

Connect your equipment

6-9

Position and connect the speakers

10-11

Change the settings

12-13

Adjust speaker output level

14

Sit back and enjoy the experience

17

## Listening caution



Selecting fine audio equipment such as the unit you've just purchased is only the start of your musical enjoyment. Now it's time to consider how you can maximize the fun and excitement your equipment offers. This manufacturer and the Electronic Industries Association's Consumer Electronics Group want you to get the most out of your equipment by playing it at a safe level. One that lets the sound come through loud and clear without annoying blaring or distortion—and, most importantly, without affecting your sensitive hearing.

We recommend you to avoid prolonged exposure to excessive noise.

Sound can be deceiving. Over time your hearing "comfort level" adapts to higher volumes of sound. So what sounds "normal" can actually be loud and harmful to your hearing.

Guard against this by setting your equipment at a safe level **BEFORE** your hearing adapts.

To establish a safe level:

- Start your volume control at a low setting.
- Slowly increase the sound until you can hear it comfortably and clearly, and without distortion.

Once you have established a comfortable sound level:

- Set the dial and leave it there.

Taking a minute to do this now will help to prevent hearing damage or loss in the future. After all, we want you listening for a lifetime.

THE FOLLOWING APPLIES ONLY IN THE U.S.A.

### CAUTION:

This equipment has been tested and found to comply with the limits for a Class B digital device, pursuant to Part 15 of the FCC Rules.

These limits are designed to provide reasonable protection against harmful interference in a residential installation. This equipment generates, uses and can radiate radio frequency energy and, if not installed and used in accordance with the instructions, may cause harmful interference to radio communications. However, there is no guarantee that interference will not occur in a particular installation. If this equipment does cause harmful interference to radio or television reception, which can be determined by turning the equipment off and on, the user is encouraged to try to correct the interference by one or more of the following measures:

- Reorient or relocate the receiving antenna.
- Increase the separation between the equipment and receiver.
- Connect the equipment into an outlet on a circuit different from that to which the receiver is connected.
- Consult the dealer or an experienced radio/TV technician for help.

Any unauthorized changes or modifications to this equipment would void the user's authority to operate this device.

This device complies with Part 15 of the FCC Rules. Operation is subject to the following two conditions: (1) This device may not cause harmful interference, and (2) this device must accept any interference received, including interference that may cause undesired operation.

### WARNING:

**TO REDUCE THE RISK OF FIRE, ELECTRIC SHOCK OR PRODUCT DAMAGE, DO NOT EXPOSE THIS APPLIANCE TO RAIN, SPLASHING, DRIPPING OR MOISTURE.**

### CAUTION:

**TO PREVENT ELECTRIC SHOCK MATCH WIDE BLADE OF PLUG TO WIDE SLOT, FULLY INSERT.**

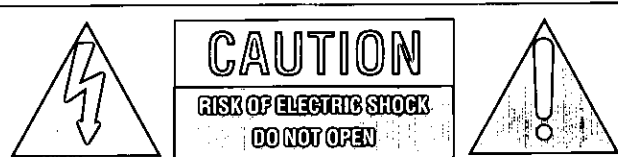

**CAUTION: TO REDUCE THE RISK OF ELECTRIC SHOCK, DO NOT REMOVE SCREWS. NO USER-SERVICEABLE PARTS INSIDE. REFER SERVICING TO QUALIFIED SERVICE PERSONNEL.**

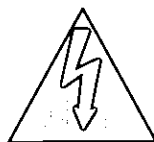

The lightning flash with arrowhead symbol, within an equilateral triangle, is intended to alert the user to the presence of uninsulated "dangerous voltage" within the product's enclosure that may be of sufficient magnitude to constitute a risk of electric shock to persons.



The exclamation point within an equilateral triangle is intended to alert the user to the presence of important operating and maintenance (servicing) instructions in the literature accompanying the appliance.

Before use

# PRECAUTIONS

Before using this unit please read these operating instructions carefully. Take special care to follow the warnings indicated on the unit itself as well as the safety suggestions listed below. Afterwards keep them handy for future reference.

## Safety

1. **Power Source** — The unit should be connected to power supply only of the type described in the operating instructions or as marked on the unit.
2. **Polarization** — If the unit is equipped with a polarized AC power plug (a plug having one blade wider than the other), that plug will fit into the AC outlet only one way. This is a safety feature. If you are unable to insert the plug fully into the outlet, try reversing the plug. If the plug should still fail to fit, contact your electrician to replace your obsolete outlet. Do not defeat the safety purpose of the polarized plug.
3. **Power Cord Protection** — AC power supply cords should be routed so that they are not likely to be walked on or pinched by items placed upon or against them. Never take hold of the plug or cord if your hand is wet, and always grasp the plug body when connecting or disconnecting it.
4. **Nonuse Periods** — When the unit is not used, turn the power off. When left unused for a long period of time, the unit should be unplugged from the household AC outlet.

## Installation

### Environment

1. **Outdoor Antenna Grounding** — If an outside antenna is connected to the receiver, be sure the antenna system is grounded so as to provide some protection against voltage surges and built-up static charges. Section 810 of the National Electrical Code, ANSI/NFPA No. 70-1990, provides information with respect to proper grounding of the mast and supporting structure, grounding of the lead-in wire to an antenna discharge unit, size of grounding conductors, location of antenna-discharge unit, connection to grounding electrodes, and requirements for the grounding electrode. See figure below.

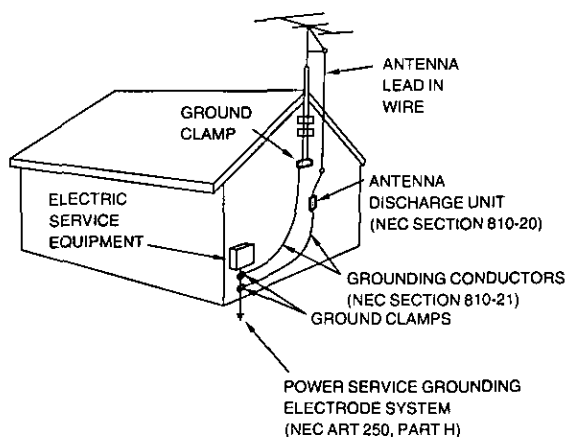

NEC—NATIONAL ELECTRICAL CODE

2. **Water and Moisture** — Do not use this unit near water—for example, near a bathtub, washbowl, swimming pool, or the like. Damp basements should also be avoided.
3. **Heat** — The unit should be situated away from heat sources such as radiators and the like. It also should not be placed in temperatures less than 5°C (41°F) or greater than 35°C (95°F).

## Placement

1. **Ventilation** — The unit should be situated so that its location or position does not interfere with its proper ventilation. Allow 10 cm (4") clearance from the rear of the unit.
2. **Foreign Material** — Care should be taken so that objects do not fall into and liquids are not spilled into the unit. Do not subject this unit to excessive smoke, dust, mechanical vibration, or shock.
3. **Magnetism** — The unit should be situated away from equipment or devices that generate strong magnetic fields.
4. **Stacking** — Do not place heavy objects, other than system components, on top of the unit.
5. **Surface** — Place the unit on a flat, level surface.
6. **Carts and Stands** — The unit should be used only with a cart or stand that is recommended by the manufacturer. The unit and cart combination should be moved with care. Quick stops, excessive force, and uneven surfaces may cause the unit and cart combination to overturn.
7. **Wall or Ceiling Mounting** — The unit should not be mounted to a wall or ceiling, unless specified in this operating instructions.



## Maintenance

Clean the cabinet, panel and controls with a soft cloth lightly moistened with mild detergent solution. Do not use any type of abrasive pad, scouring powder or solvent such as alcohol or benzene.

## Service

1. **Damage Requiring Service** — The unit should be serviced by qualified service personnel when:
  - (a) The AC power supply cord or the plug has been damaged; or
  - (b) Objects have fallen or liquid has been spilled into the unit; or
  - (c) The unit has been exposed to rain; or
  - (d) The unit does not appear to operate normally or exhibits a marked change in performance; or
  - (e) The unit has been dropped, or the enclosure damaged.
2. **Servicing** — The user should not attempt to service the unit beyond that described in the operating instructions. All other servicing should be referred to an authorized service personnel. **For the address of an authorized servicer:**  
**In the U.S.A., call 1-800-211-7262 or visit [www.panasonic.com](http://www.panasonic.com)**  
**In Canada, call 905-624-5505 or visit [www.panasonic.ca](http://www.panasonic.ca)**

# Control reference guide

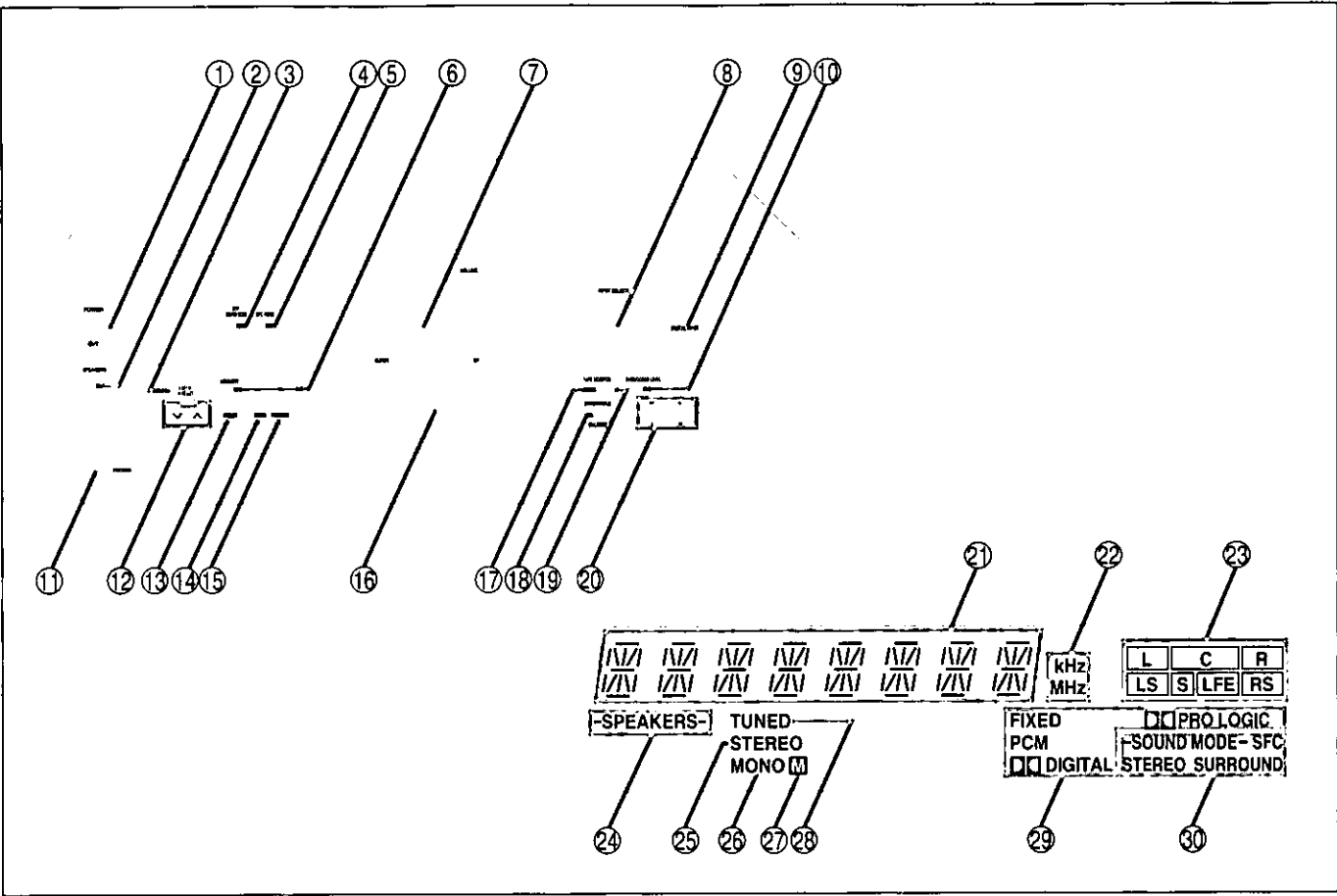

Before use

Reference pages are given in parentheses.

## Main unit

- ① Standby/on button [POWER,  $\odot/\updownarrow$ ] .....(13)  
Press to switch the unit from on to standby mode or vice versa.  
In standby mode, the unit is still consuming a small amount of power.
- ② Speaker on/off button [SPEAKERS] .....(14, 17)
- ③ Help/reset button [-HELP/-RESET] .....(22)
- ④ DSP sound mode select button  
[DSP SOUND MODE] .....(13, 17)
- ⑤ SFC mode select button [SFC MODE] .....(13, 17)
- ⑥ Memory button [MEMORY] .....(21)
- ⑦ Volume control [VOLUME] .....(17)
- ⑧ Input selector [INPUT SELECTOR] .....(13, 17)
- ⑨ Digital input select button/indicator [DIGITAL INPUT] .....(17)
- ⑩ Subwoofer level button [SUBWOOFER LEVEL] .....(19)
- ⑪ Headphone jack [PHONES] .....(18)
- ⑫ Tuning buttons [TUNING,  $\vee$ ,  $\wedge$ ] .....(20)
- ⑬ Preset channel button [PRESET] .....(21)
- ⑭ Band select button [BAND] .....(20)
- ⑮ FM mode select button [FM MODE] .....(20)
- ⑯ Display section
- ⑰ Tape monitor button [TAPE MONITOR] .....(19)
- ⑱ Tone and balance select button  
[BASS/TREBLE, BALANCE] .....(18)
- ⑲ Tape monitor indicator .....(19)
- ⑳ Tone and balance adjust buttons [-, +, L, R] .....(18)

## Display section

- ⑰ Display
- ⑱ Frequency unit indicators [kHz, MHz] .....(20)
- ⑲ Program format indicators [L, C, R, LS, S, LFE, RS] .....(17)
- ⑳ Front speaker indicator [-SPEAKERS-] .....(17)
- ㉑ Stereo indicator [STEREO] .....(20)
- ㉒ Monaural indicator [MONO] .....(20)
- ㉓ Memory indicator [M] .....(21)
- ㉔ Tuned indicator [TUNED] .....(20)
- ㉕ Signal format indicators  
[FIXED, PCM,  $\square\square$  DIGITAL,  $\square\square$  PRO LOGIC] .....(17)
- ㉖ DSP sound mode indicators  
[-SOUND MODE-, SFC, STEREO, SURROUND] .....(17)

Refer to the separate booklet, "Remote Control", for a guide to the remote control's buttons.

# Connections

## Stereo connection cable

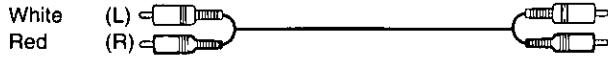

## Video connection cable



To connect equipment, refer to the appropriate operating instructions.

Peripheral equipment and cables sold separately unless otherwise indicated.

### Note

- Turn off all components before making any connections.
- Use digital connection to enjoy Dolby Digital (⇒ page 17).
- Use analog connection to enjoy sources that cannot be decoded on this unit and to record a source (⇒ pages 15 and 22).

## Connecting video equipment

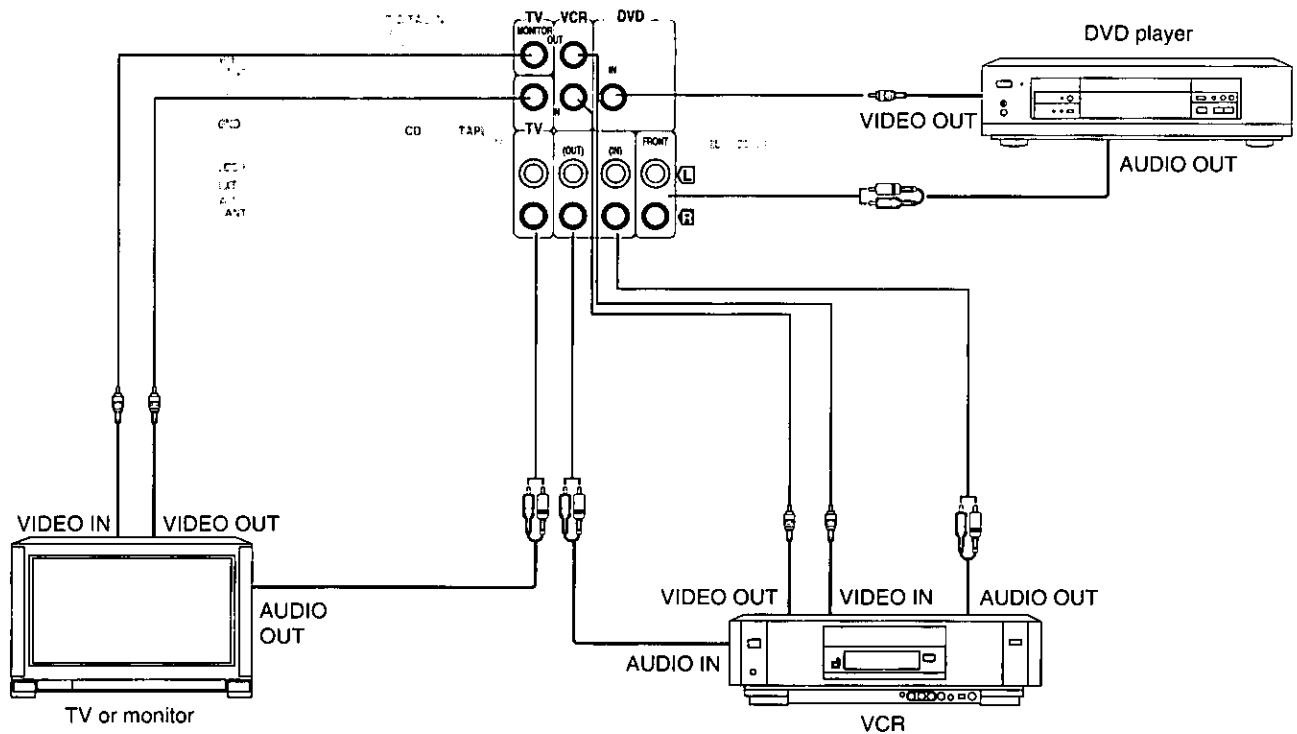

Optical fiber cable

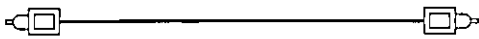

Coaxial cable



## Connecting audio equipment

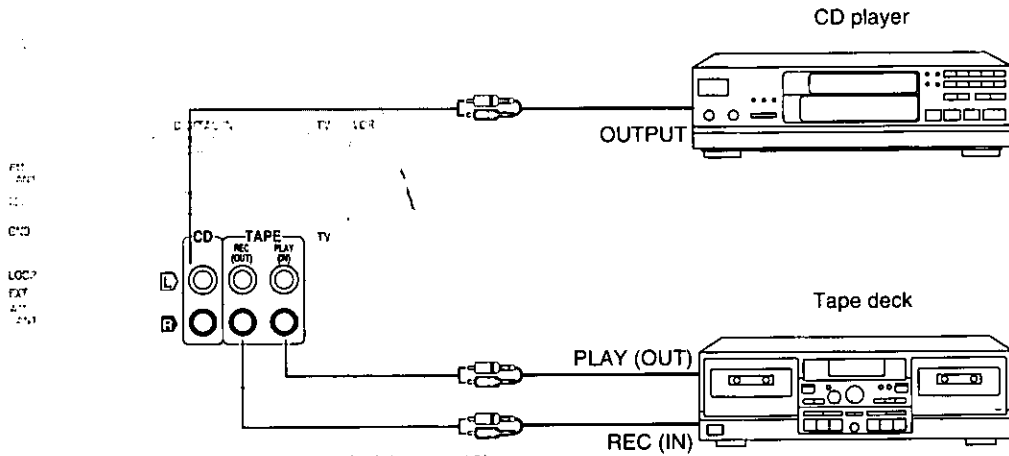

### Note

If you have a graphic equalizer, connect it to the TAPE terminals (⇒ page 19).

## Connecting digital equipment

Satellite receiver, etc.

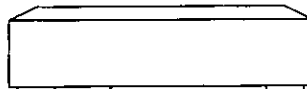

DIGITAL OUT

### Optical fiber cable connection

Dust cap

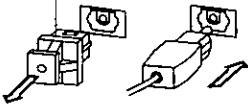

- Do not bend the optical fiber cable.
- If the digital optical connector is not going to be used, be sure to attach the dust cap to prevent exposure to dust.

### Note

This unit cannot decode Dolby Digital RF (radio frequency) signals from a laser disc player.

### Changing the digital input settings

You can change the input settings for the digital terminals if necessary (for example, if your CD player doesn't have a coaxial output terminal). Note the equipment you have connected to the terminals, then change the settings (⇒ pages 12–13).

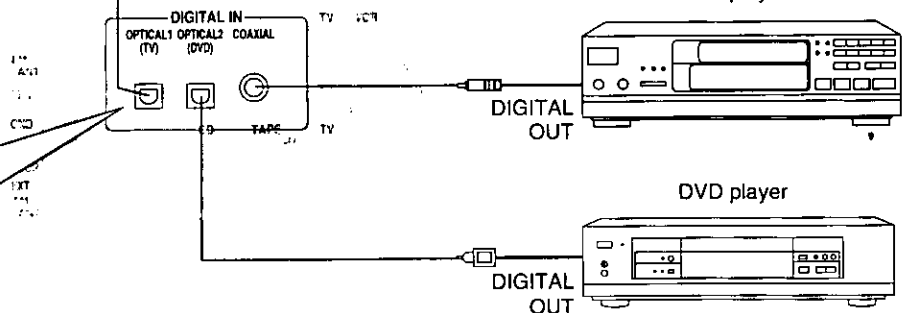

## Antenna connections

### FM antenna

Fix the other end of the antenna where reception is best.

FM indoor antenna (included)

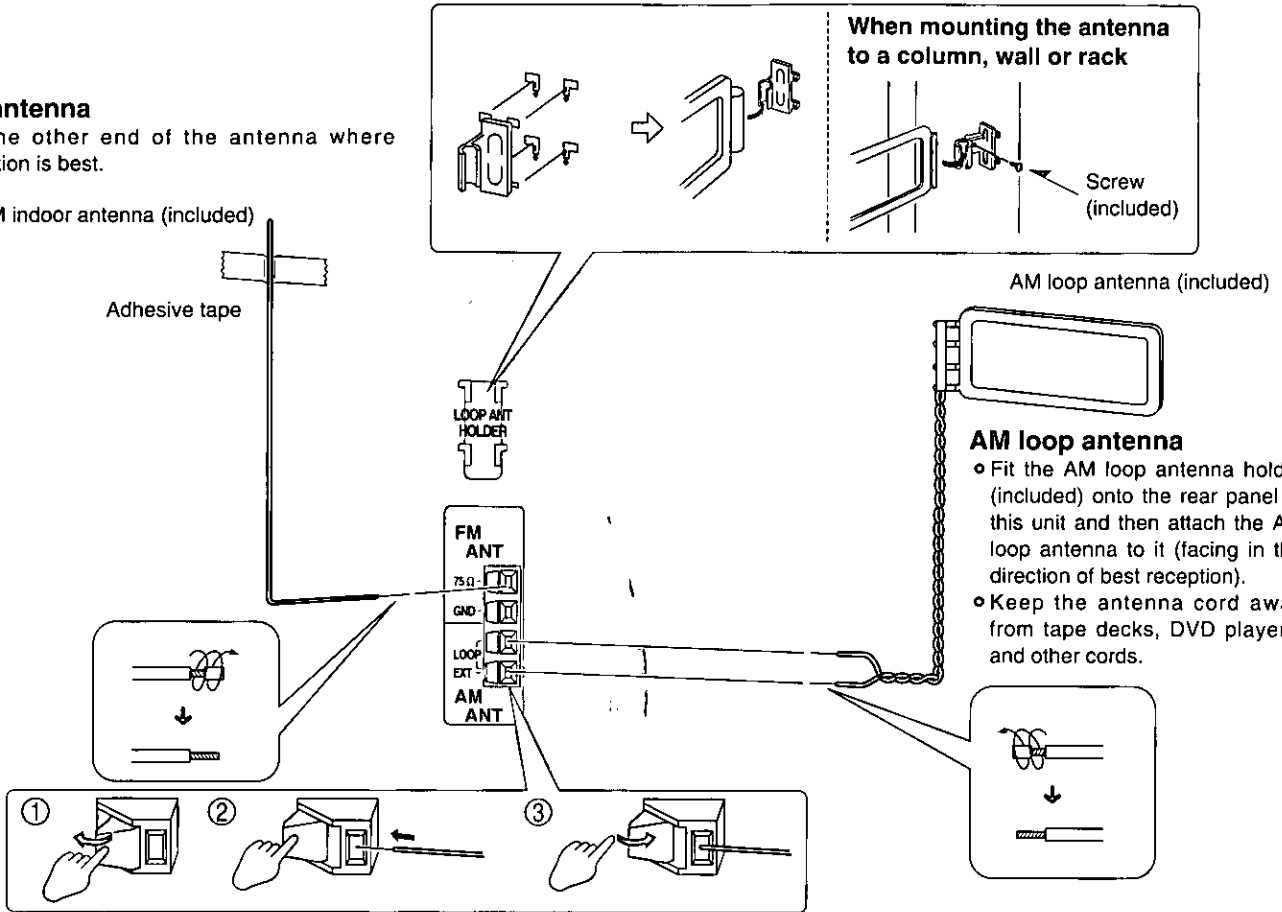

## To connect an outdoor antenna

### FM outdoor antenna

- Disconnect the FM indoor antenna.
- The antenna should be installed by a competent technician.
- Twist the coaxial cable's shield braid firmly and connect it to the GND terminal.

### AM outdoor antenna

- Run a piece of vinyl wire horizontally across a window or other convenient location.
- Leave the loop antenna connected.
- Disconnect the antenna when the unit is not in use. Do not use the antenna during an electrical storm.

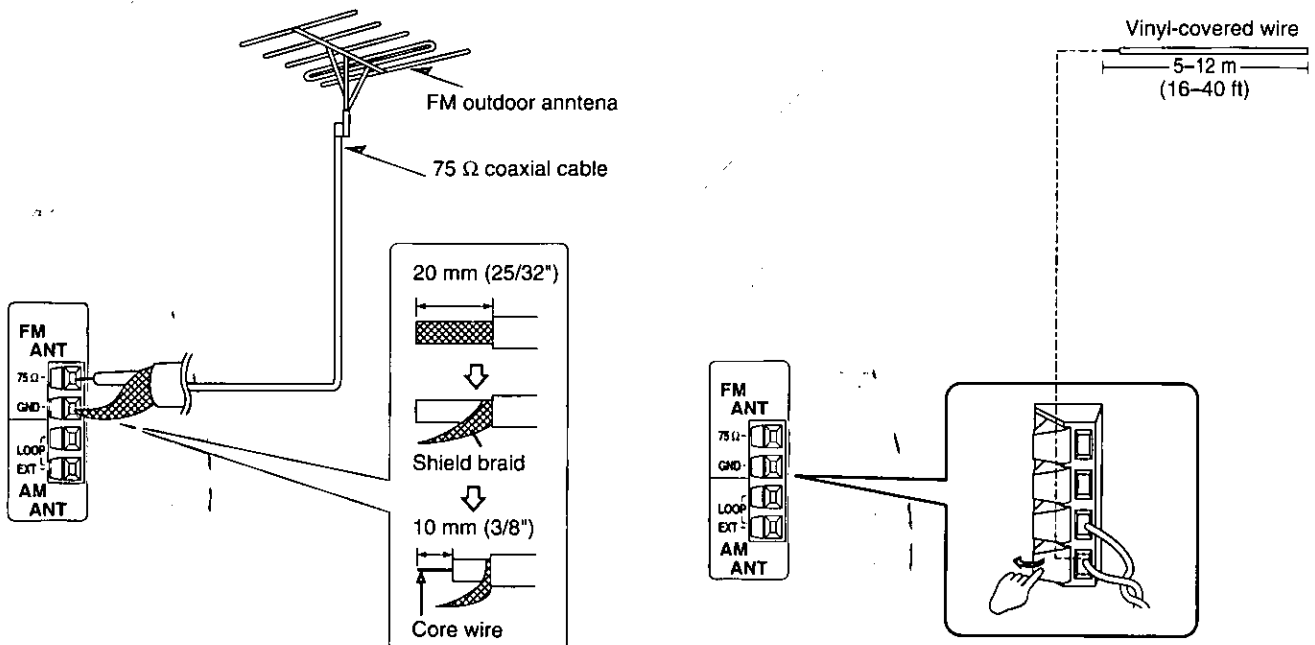



## Connecting the AC power supply cord and other information

### "SWITCHED" AC outlet

Power to the outlet is controlled by the power switch of this unit. Audio equipment rated up to a maximum of 80 W can be connected here. If equipment exceeding this rating is connected, the outlet may be rendered inoperable. Consult your dealer to replace the fuse.

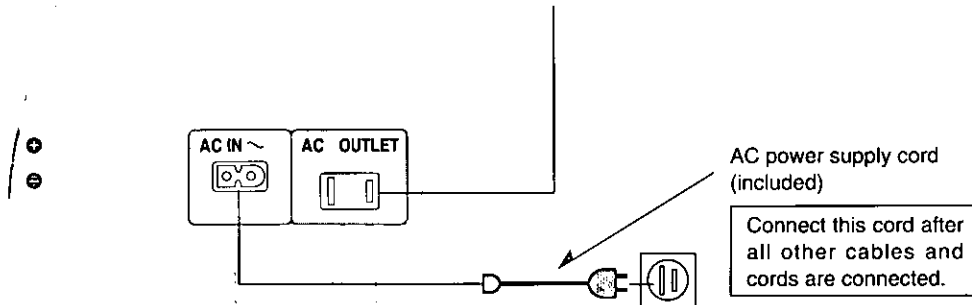

Household AC outlet  
(AC 120 V/60 Hz)

### Note:

The included AC power supply cord is for use with this unit only. Do not use it with other equipment.

### Conserving power

The unit consumes 1 W even when it is turned off with [POWER,  $\odot$ /I]. To save power when the unit is not to be used for a long time, unplug it from the household AC outlet.

If the unit is left unplugged for longer than a few weeks, all settings will revert to the factory settings. Do the settings again if this occurs.

# Speaker connections

## Placement of speakers

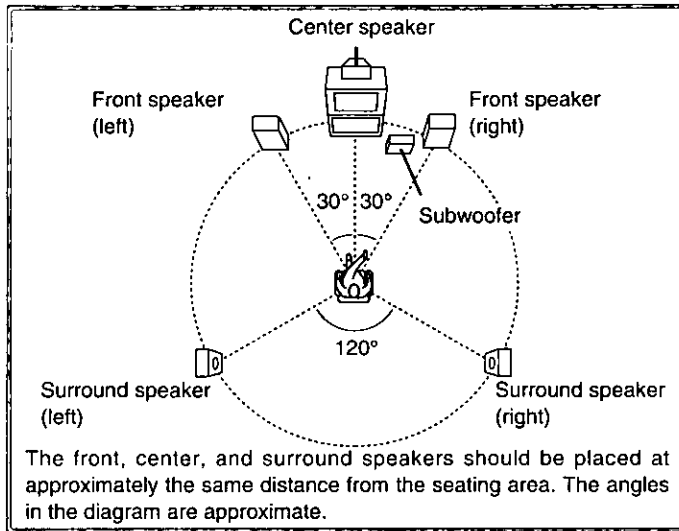

### Front speakers

Place on the left and right of the TV at seated ear height so that there is good coherency between the picture and sound.

### Center speaker

Place underneath or above the center of the TV. Aim the speaker at the seating area.

### Surround speakers

Place on the side of or slightly behind the seating area, about one meter higher than ear level.

### Subwoofer

The subwoofer can be placed in any position as long as it is at a reasonable distance from the TV.

Note that some experimentation can yield the smoothest low frequency performance. Placement near a corner can increase the apparent output level, but can result in unnatural bass.

## Connecting speakers

Other connections are possible depending on your speaker system. See your speaker system's operating instructions for details.

### Front speakers

**Speaker impedance:** 6-8  $\Omega$

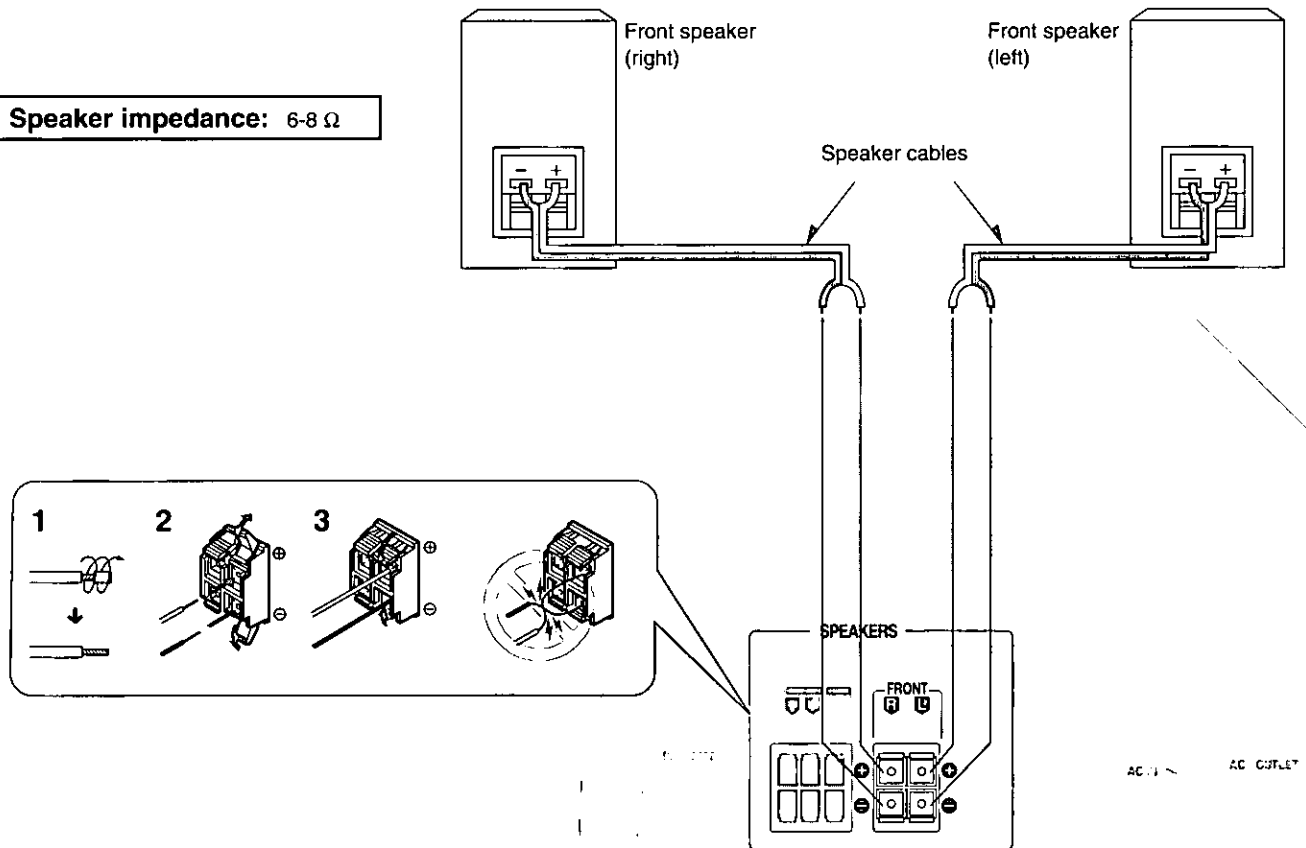

## Center speaker

Speaker impedance: 6-8 Ω

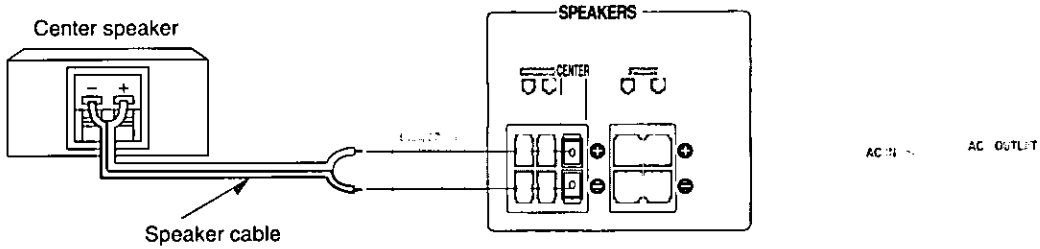

## Surround speakers

Speaker impedance: 6-8 Ω

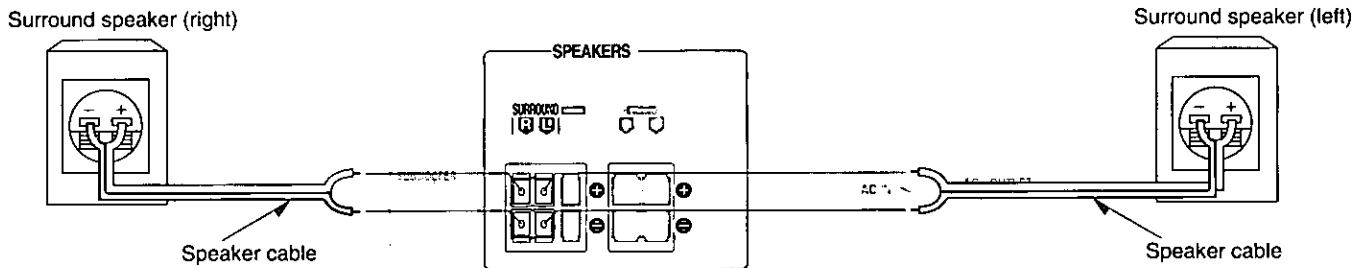

## Subwoofer

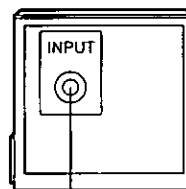

### Note

This receiver does not have an amplifier for the subwoofer.

#### To connect a passive subwoofer

- Connect another amplifier and connect the subwoofer to it.

Or

- Connect a passive subwoofer that has front speaker terminals

(See the operating instructions of the speaker system for details.)

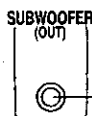

Monaural connection cable

# Customizing your receiver

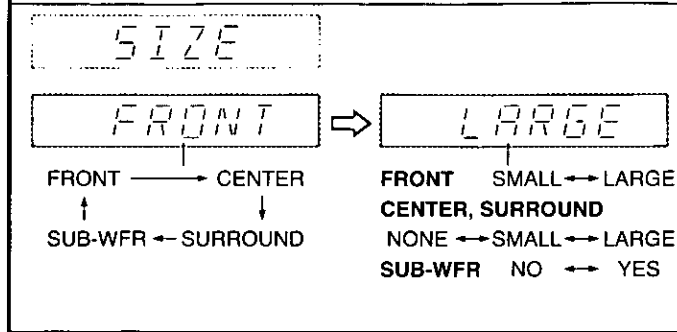

Change the settings to suit your speakers and equipment and to suit the environment in which the unit is to be used. Before making any changes, read the following descriptions, note the factory settings and ranges, and refer to the instructions for the speakers and equipment.

The settings remain intact until they are changed, even after the power is turned off.

## Setting descriptions

### SIZE

Change to suit the speakers you have connected.

**LARGE:** For speakers that can reproduce a full sound range, particularly the bass range below 100 Hz.

**SMALL:** For speakers that cannot adequately reproduce the bass range. This setting is sufficient for most speakers if you are using a subwoofer.

**NONE:** For speakers you haven't connected (center or surround).

The factory settings are: Front: LARGE  
Center and surround: SMALL

For the subwoofer, select YES if you have connected one (factory setting), or NO if you have not.

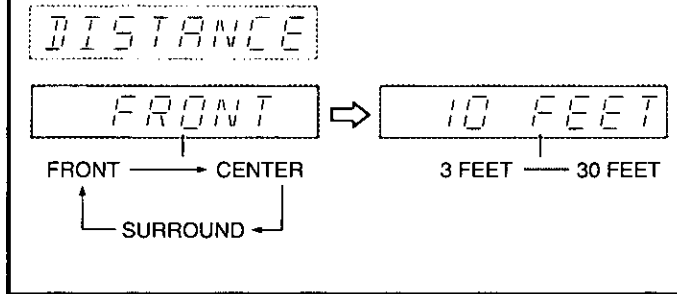

### DISTANCE

Enter the distance of the speakers from the seating position so that the sound from all the speakers (except for the subwoofer) reaches you at the same time.

You can select distances between 3 and 30 feet at one-foot intervals.

The factory settings are: Front and center: 10 FEET  
Surround: 5 FEET

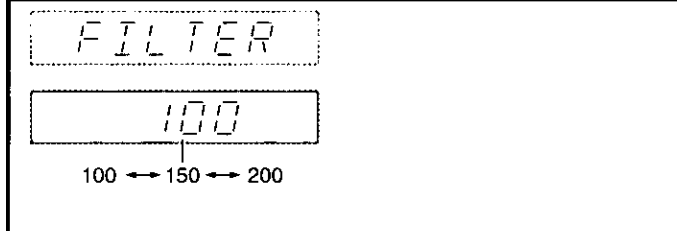

### FILTER

This setting allows you to change the cut-off for bass output from the front speakers. If you set the front speakers to "SMALL", the filter is set to 100 Hz. Raise the cut-off if the bass from the front speakers is unsatisfactory so that this bass is output through the subwoofer.

You can raise the cut-off from 100 Hz to either 150 Hz or 200 Hz.

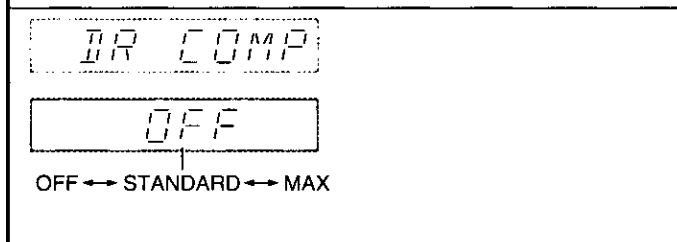

### DR COMP - Dynamic range compression

Change this setting to listen to software at low volume (such as late at night) and maintain audio clarity. This setting works with Dolby Digital software. It reduces the peak level in loud scenes without affecting the sound field.

**OFF:** The software is played with the original dynamic range (factory setting).

**STANDARD:** The level recommended by the producer of the software for household viewing.

**MAX:** The maximum allowable compression (recommended for night viewing).

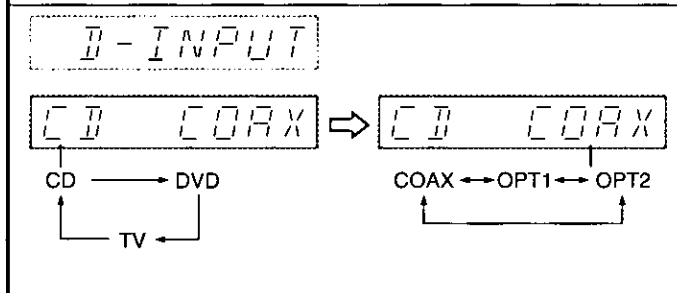

### D-INPUT - Digital input

Change these settings to suit the connections you have made to the three digital input terminals, COAX, OPT1, and OPT2 (⇒ page 7), so that the correct source is selected when you turn [INPUT SELECTOR] (⇒ page 17).

The factory settings are: CD: COAX  
DVD: OPT2  
TV: OPT1

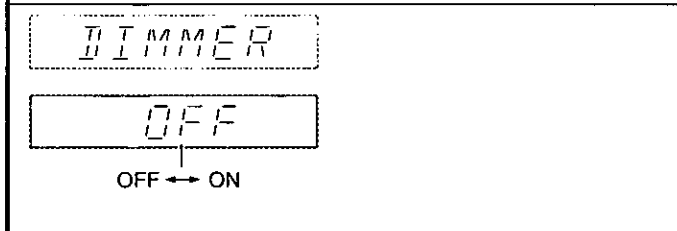

### DIMMER

This setting allows you to dim the unit's display for better viewing in a darkened room.

The factory setting is OFF (normal brightness).

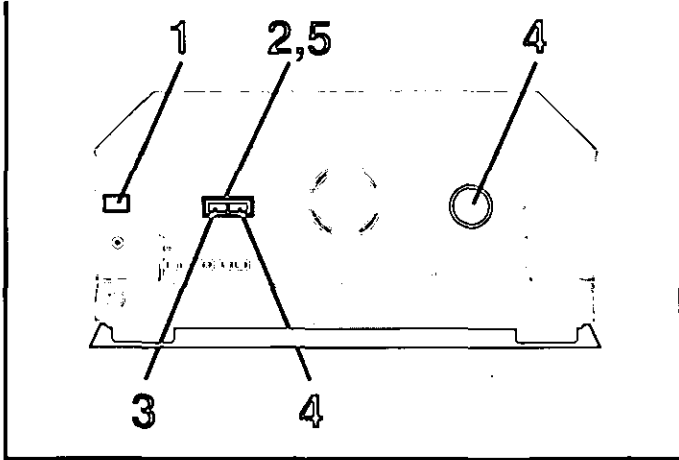

**Basic steps**

If you allow about 10 seconds to elapse between settings, the procedure is canceled, all settings are returned to how they were, and the previous display is restored. Begin again if this occurs.

- 1 Press [POWER,  $\phi$ /I].
- 2 Press [DSP SOUND MODE] and [SFC MODE] at the same time.
- 3 Press [DSP SOUND MODE] to select the item you want to change.  
Each time you press the button:  
SIZE → DISTANCE → FILTER → DR COMP → D-INPUT → DIMMER

- 4 Change the settings (⇌ below).

Repeat steps 3 and 4 to complete the necessary settings.

- 5 Press [DSP SOUND MODE] and [SFC MODE] at the same time.

**Changing the settings**

**SIZE**

- 1 Press [SFC MODE] to select the speaker you want to set.  
Each time you press the button:  
FRONT → CENTER → SURROUND → SUB-WFR (Subwoofer)
- 2 Turn [INPUT SELECTOR] to change the setting.  
When you turn the selector:  
FRONT: SMALL ↔ LARGE  
CENTER and SURROUND: NONE ↔ SMALL ↔ LARGE  
SUB-WFR: NO ↔ YES
- 3 Repeat 1 and 2 to change other SIZE settings.

**DISTANCE**

- 1 Press [SFC MODE] to select the speaker you want to set.  
Each time you press the button:  
FRONT → CENTER → SURROUND
- 2 Turn [INPUT SELECTOR] to set the distance.
- 3 Repeat 1 and 2 to change other DISTANCE settings.

**FILTER**

Turn [INPUT SELECTOR] to set the cut-off.  
When you turn the selector:  
100 ↔ 150 ↔ 200

**DR COMP**

Turn [INPUT SELECTOR] to change the setting.  
When you turn the selector:  
OFF ↔ STANDARD ↔ MAX

**D-INPUT**

- 1 Press [SFC MODE] to select the input position you want to set.  
Each time you press the button:  
CD COAX → DVD OPT2 → TV OPT1

These are the factory settings. Actual displays depend on the changes you make. If you change one setting, the other corresponding setting will also change.

- 2 Turn [INPUT SELECTOR] to change the setting.  
When you turn the selector:  
COAX ↔ OPT1 ↔ OPT2

- 3 Repeat 1 and 2 to change other D-INPUT settings.

**DIMMER**

Turn [INPUT SELECTOR] to change the setting.  
When you turn the selector:  
OFF ↔ ON

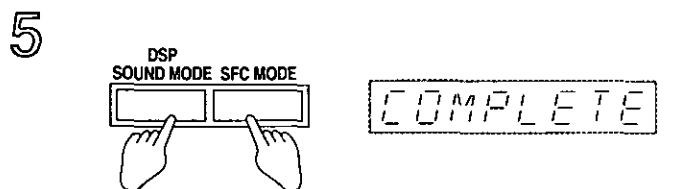
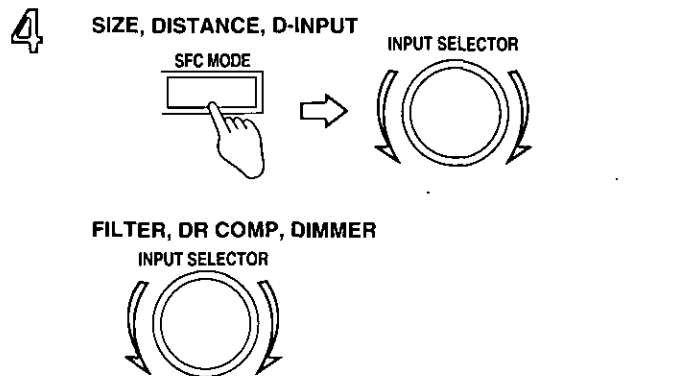
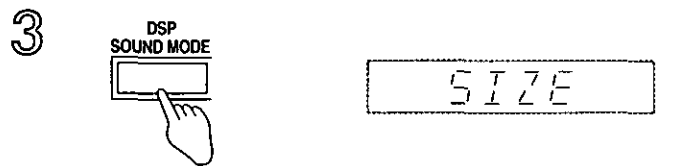
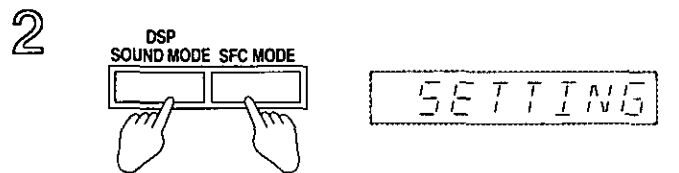

# Adjusting speaker output level

Adjust the level of the speakers so they are the same apparent level as the front speakers when you are sitting where you would normally enjoy a source.

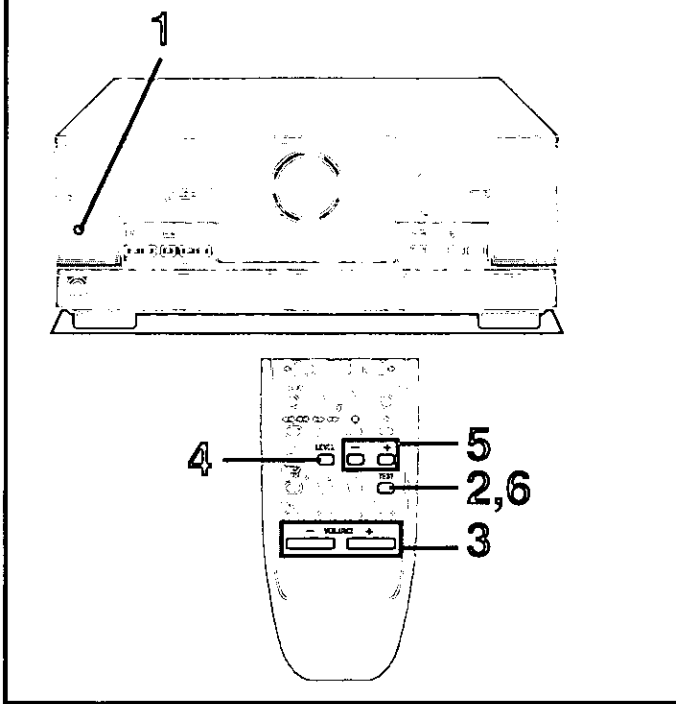

- 1 Press [SPEAKERS] to turn on SPEAKERS.**
- 2 Press [TEST] to output the test signal.**  
DSP sound mode switches to SURROUND mode.  
The signal is output from each speaker in order for about two seconds each:  
L: Front speaker (left)  
C: Center speaker  
R: Front speaker (right)  
RS: Surround speaker (right)  
LS: Surround speaker (left)  
SW: Subwoofer  
Speakers set as "NONE" or "NO" are skipped.

**Note**

The test signal will not be output if DSP is defeated (⇒ page 20).

- 3 Adjust the volume to the level normally used.**  
Adjust the balance of the front speakers if necessary (⇒ page 18).
- 4 Press [LEVEL] to select the speaker channel to adjust.**  
The current level appears on the display.  
Press again to change the speaker channel.  
  
Speakers set as "NONE" or "NO" are skipped.
- 5 Press [-] or [+] to adjust the level to the same apparent level as the front speakers.**  
C, RS, and LS can be adjusted between -10 dB and +10 dB, with zero being the current level of the front speakers.  
SW can be set to MIN, between 1 to 19, or MAX.

Repeat steps 4 and 5 for each speaker channel.

- 6 Press [TEST] to stop the test signal.**

**For your reference**

Subwoofer output is easily influenced by the source played. You can achieve better results by adjusting its output while listening to a source (⇒ page 19).

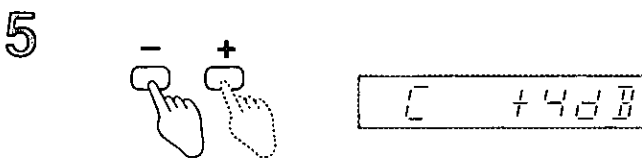
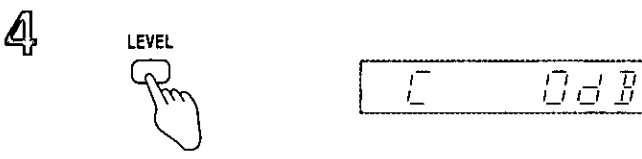
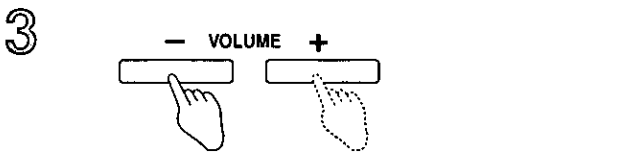
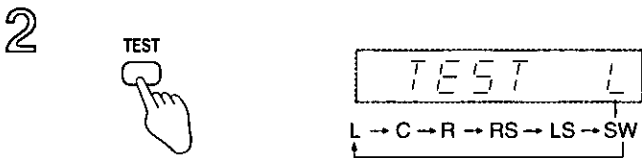
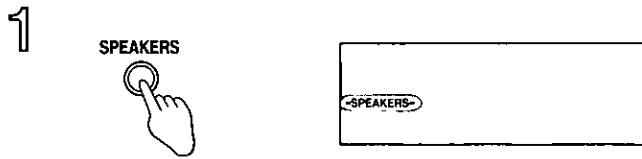

## DSP sound modes

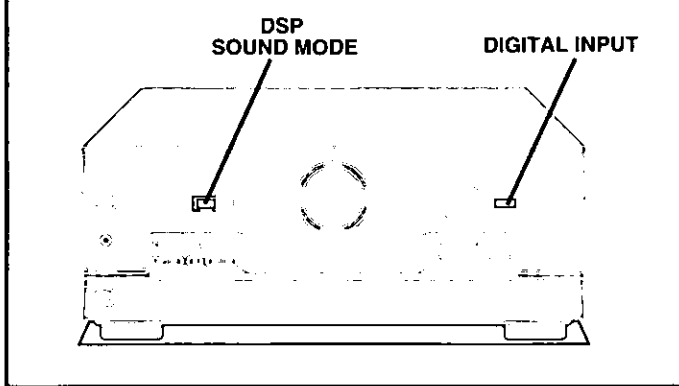

The digital sound processor (DSP) in this unit can decode Dolby Digital signals. It automatically determines the type of signal, PCM or Dolby Digital, and processes it accordingly.

The DSP can add surround-like effects to stereo sources (analog or PCM signals).

Choose from the STEREO, SURROUND, or SFC modes.

The DSP may interfere with radio reception. You can turn it off if this occurs (⇒ page 20).

Output is in stereo when you turn the DSP off so sound is only heard through the front speakers.

### Note

- PCM with a sampling frequency of 44.1 kHz is the digital signal format normally found on CDs. Some DVDs also use this format but often with a higher sampling rate.
- This unit cannot process other digital signal formats, such as DTS, PCM signals with sampling frequencies of 96 kHz and 192 kHz, and MPEG.



### A STEREO mode

Use this mode to play digital or analog stereo sources or to play surround sources through two speakers. When surround sources are played in this mode, the sounds intended for the other speaker channels are played through the front speakers.

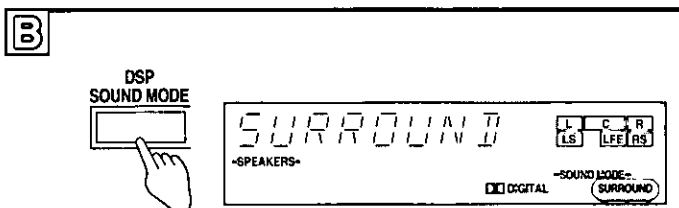

### B SURROUND mode

Select this mode when you are playing a Dolby Digital surround source or an analog source that is recorded with Dolby Surround (VCR, for example).

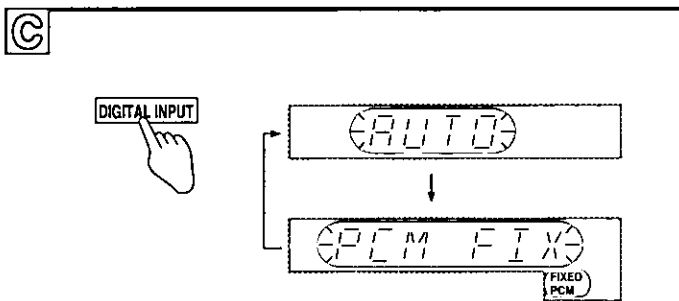

### C Changing the recognition mode

In rare cases, the unit may have trouble recognizing the digital signals on discs. With the PCM signals on CDs, this may cause the beginning of a track to be cut off. Engage the PCM FIX mode if this occurs.

This mode does not need to be changed under normal circumstances. Change it only if the unit appears to be having trouble recognizing the software you are playing.

While the input source is selected and digital input is engaged:

**Press and hold [DIGITAL INPUT].**

The current mode is displayed. Press again to change the mode.

Each time you press the button:

AUTO ↔ PCM FIX

When the PCM FIX mode is on, the unit cannot process other signals. This may cause noise to be output. Select "AUTO" if this occurs.

The selected mode is stored even if the unit is turned off.

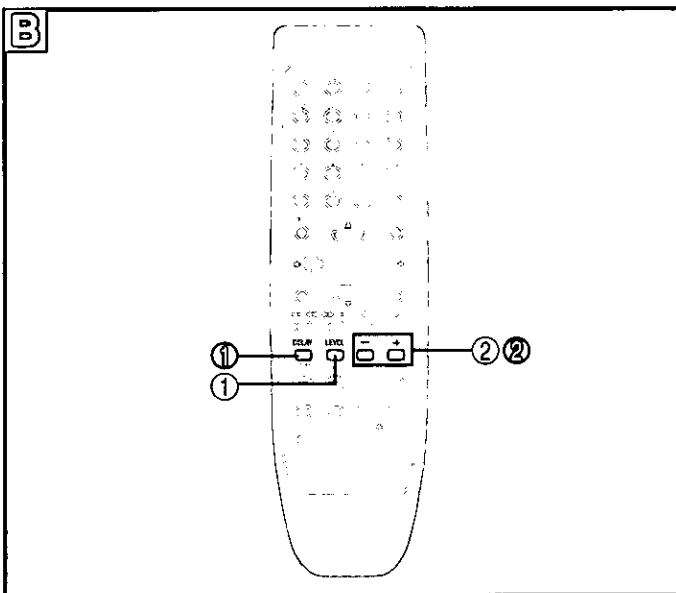
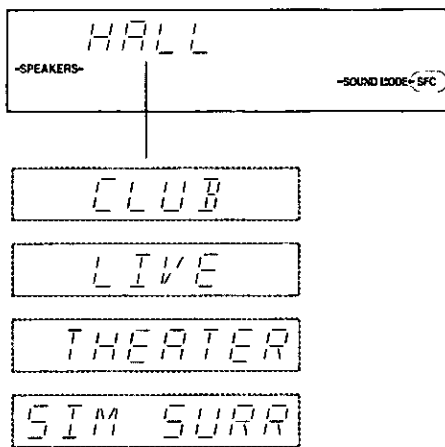
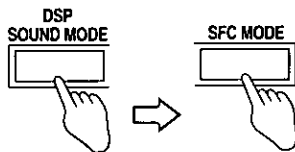
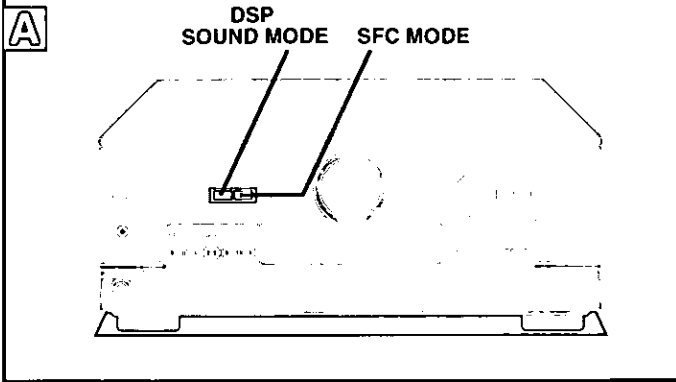

**A SFC modes**

Enjoy an enhanced sound experience with greater presence and spread by using these SFC (sound field control) modes with PCM or analog stereo sources. The SFC modes cannot be used if the input signal is Dolby Digital.

Choose from the following modes.

**HALL**

Imparts the reflection and spread of a large concert hall.

**CLUB**

Conveys the exciting and intimate atmosphere of a jazz club.

**LIVE**

Brings you up close for "live" stage performance and smoother vocals.

**THEATER**

Recreates natural sound ambience and direction.

**SIM SURR (Simulated Surround)**

Heightens the sensation of expanded space with stereo sources, and augments monaural sources.

**B Adjusting the sound field**

You can adjust the sound field by adjusting the level of the speakers and the delay time of the surround speakers. These adjustments can be made for each SFC mode.

**To adjust the speaker level**

① Press [LEVEL] to select the speaker channel.

Each time you press the button:

C → RS → LS → SW



Speakers set as "NONE" or "NO" are skipped.

② Press [-] or [+] to adjust the level.

C, RS, and LS:

-10 dB to +10 dB

SW:

-- (off) ↔ MIN ↔ 1-19 ↔ MAX

**To adjust the delay time**

① Press [DELAY].

② Press [-] or [+] to change the delay time.

Delay time can be set at 10-millisecond (ms) intervals between 10 and 100 ms.

The factory setting is 50 ms for each mode.



# Enjoying the sounds

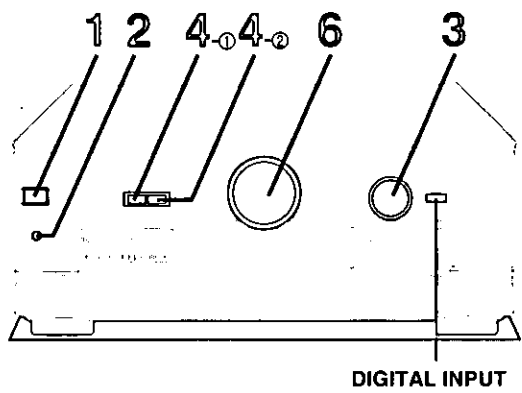

- 1 Press [POWER,  $\phi$ /I].
- 2 Press [SPEAKERS] to turn on SPEAKERS.
- 3 Turn [INPUT SELECTOR] to select the input source.

To switch between analog and digital input (CD, DVD, and TV)

Press [DIGITAL INPUT].

Each time you press the button:

ANALOG ↔ DIGITAL

The indicator lights when you select "DIGITAL".

Once you have set the mode for a source, that mode is engaged whenever you select that source.

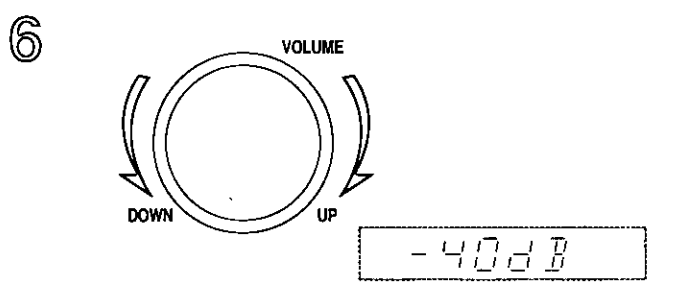
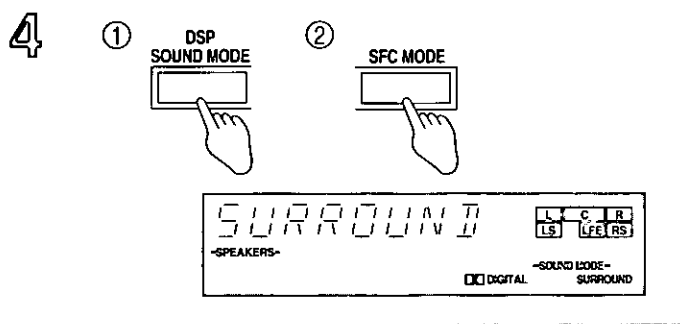
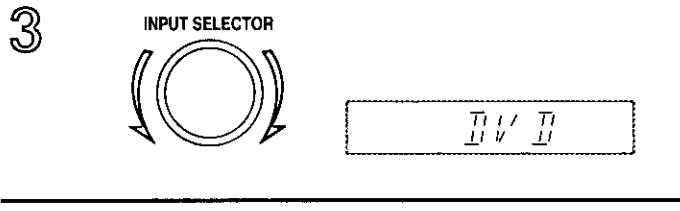
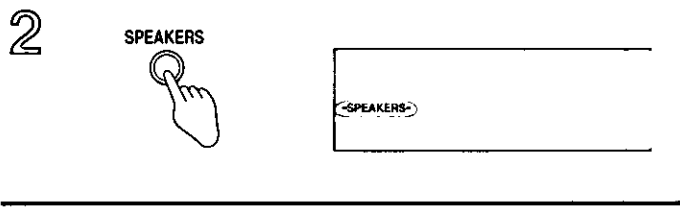

## 4 Select the DSP sound mode.

① Press [DSP SOUND MODE].

The indicator corresponding to the mode lights.

Select the mode appropriate to the source (↔ pages 15–16).

② When you select "SFC"

Press [SFC MODE].

Once you have set the mode for a source, that mode is engaged whenever you select that source.

## 5 Start playing the source.

Refer to the equipment's instructions for details.

## 6 Adjust the volume.

### When you finish listening

Be sure to reduce the volume and press [POWER,  $\phi$ /I] to switch the unit to standby.

### For your reference

- If you are using a VCR and you select TAPE, CD or TUNER  
The picture will remain on the screen.
- The signal format indicators  
The following indicators light depending on the source you are playing.
  - DIGITAL  
Dolby Digital Sources
  - PRO LOGIC  
Analog sources in SURROUND mode  
Digital sources with PCM signals in SURROUND mode  
Dolby Digital sources that contain Dolby Pro Logic in SURROUND mode
- The program format indicators (L, C, R, LS, S, LFE, RS)  
The program format indicators light up to indicate the channels contained in the digital input signal. They do not light when input is analog.
  - L: Front channel (left)
  - C: Center channel
  - R: Front channel (right)
  - LS: Surround channel (left)
  - RS: Surround channel (right)
  - S: If the surround channel is monaural.
  - LFE (Low Frequency Effect): Deep-bass effect.

Manufactured under license from Dolby Laboratories. "Dolby", "Pro Logic" and the double-D symbol are trademarks of Dolby Laboratories. Confidential unpublished works. © 1992-1997 Dolby Laboratories. All rights reserved.

## Enjoying the sounds

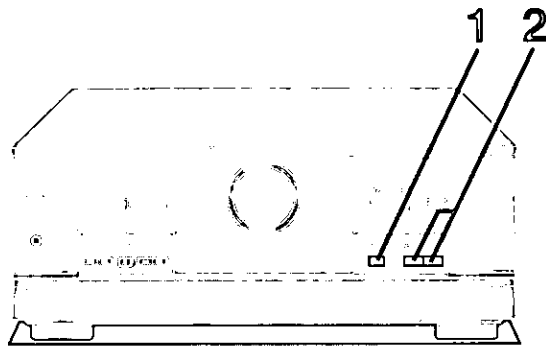
**A**

### A Adjusting the tone and balance

You can adjust the tone (BASS and TREBLE) only when the DSP sound mode is STEREO and input is either analog or PCM. You cannot adjust the tone while the DSP is defeated.

#### 1 Press [BASS/TREBLE, BALANCE].

Each time you press the button:  
BASS → TREBLE → BALANCE

BASS: To adjust the bass

TREBLE: To adjust the treble

BALANCE: To adjust the left/right sound balance

#### 2 Press [-, L] or [+ , R].

-, L: to lower the selected tone or shift the balance to the left speaker.

+, R: to raise the selected tone or shift the balance to the right speaker.

The previous display returns after a few seconds.

1

BASS/TREBLE

BALANCE



BASS

2

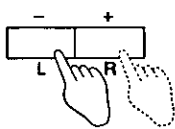

BASS, TREBLE

000

-10 dB — +10 dB

BALANCE

L 7 R

### B Using headphones

#### ① Press [SPEAKERS] to turn off the speakers.

Turning the speakers off automatically engages STEREO mode and ensures no sound is heard from the subwoofer.

(Sound will seem unusual if you use another DSP mode.)

#### ② Reduce the volume.

#### ③ Connect the headphones (not included).

Plug type: 6.3 mm (1/4") stereo

#### ④ Adjust the volume.

#### Note

Avoid listening for prolonged periods of time to prevent hearing damage.

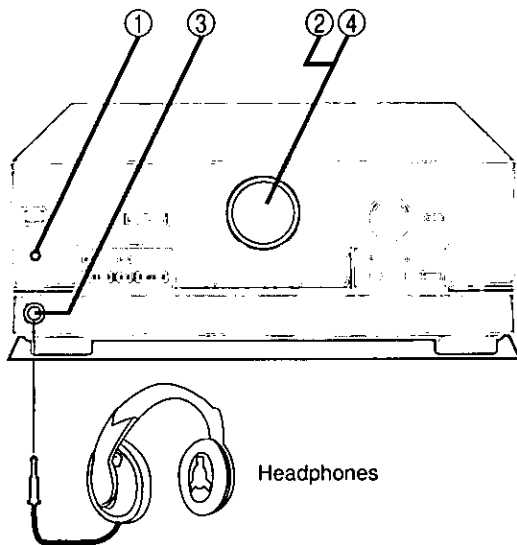
**B**

Headphones

## Enjoying the sounds

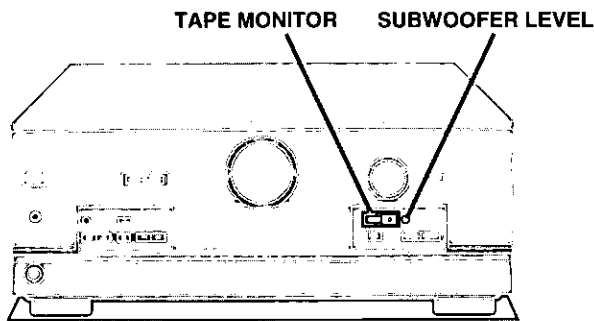

### A Muting the volume

#### Press [MUTING].

The message "MUTING ON NOW" runs repeatedly from right to left across the display as long as the muting function is on.

#### To cancel

Press [MUTING].

Muting is also canceled when the unit is turned off.

### B Adjusting the subwoofer level

You can adjust the volume of the subwoofer while listening to a source. No sound is heard from the subwoofer if "SW ---" is selected. This setting can be done for each DSP mode.

You cannot adjust the subwoofer level while the DSP is defeated.

The factory setting is "SW 10".

#### Press [SUBWOOFER LEVEL].

The current setting is shown.

Each time you press the button:

SW --- → SW MIN → SW 5 → SW 10 → SW 15 → SW MAX

#### To make finer adjustments

① Press [LEVEL] to select "SW".

② Press [-] or [+].

#### Note

Sound from the subwoofer can be distorted if you raise the unit's volume while subwoofer level is high. Reduce subwoofer level if this occurs.

### C Using the TAPE MONITOR

Use the tape monitor if you have connected a graphic equalizer to the TAPE terminals.

#### Press [TAPE MONITOR].

The "TAPE MONITOR" indicator lights and the tape monitor comes on.

Sources other than tape can still be selected with [INPUT SELECTOR] while the "TAPE MONITOR" indicator is on.

Press [TAPE MONITOR] again to turn the tape monitor off.

(⇒ See "Making a recording" on page 22 for details on how to use the tape monitor during recording.)

#### Note

- The tape monitor cannot be used when input is digital and turns off if you select digital input.
- Depending on the setting, the graphic equalizer can cause distortion.

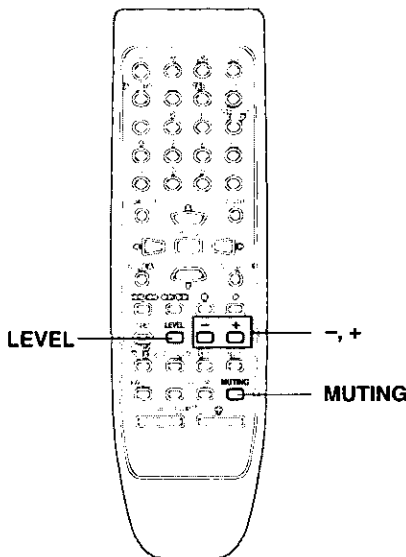

A

MUTING

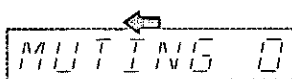

B

SUBWOOFER LEVEL

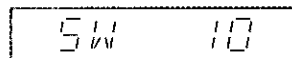

C

TAPE MONITOR



⊗

# The radio

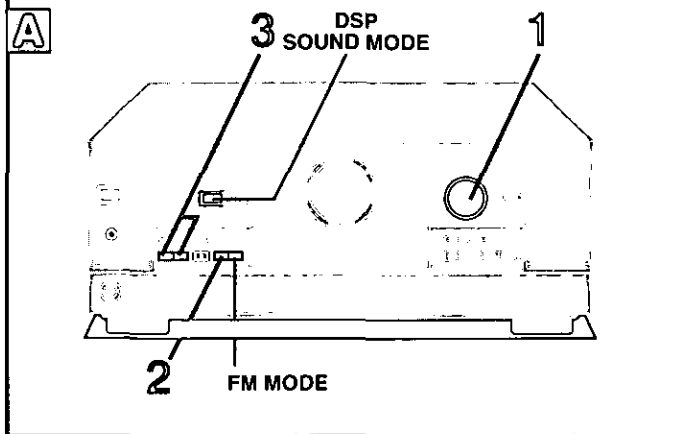

## A Manual tuning

You can tune radio stations manually by selecting the station's frequency, or you can preset up to 30 stations into channels to make tuning simpler (⇒ page 21).

- 1 Turn [INPUT SELECTOR] to select "TUNER".
- 2 Press [BAND] to select "FM" or "AM".
- 3 Press [TUNING ∨ or ∧] to select the frequency of the station.

Tuning intervals: FM – 0.2 MHz  
AM – 10 kHz

"TUNED" lights when tuned.

"STEREO" lights during FM stereo broadcasts.

### Automatic tuning

Hold down [TUNING ∨ or ∧] until the frequency begins to scroll. Tuning stops when a station is found. (Tuning may stop if there is interference.)

### Improving reception

#### FM mode

You can improve FM reception by switching reception to monaural. Press [FM MODE].

"MONO" lights.

Press [FM MODE] again to cancel.

#### DSP DEFEAT

You can improve reception by turning off the DSP (⇒ page 15).

Press and hold [DSP SOUND MODE] until "DEFEAT" appears.

Press and hold [DSP SOUND MODE] again to turn the DSP on.

#### For your reference

DVD players can interfere with radio reception. Turn the DVD player off or move it further away from the antennas if this occurs.

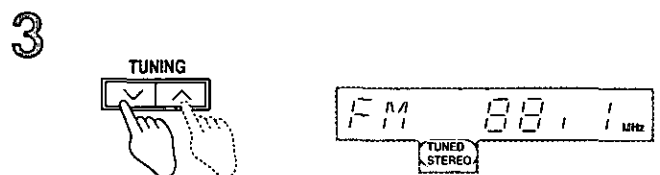
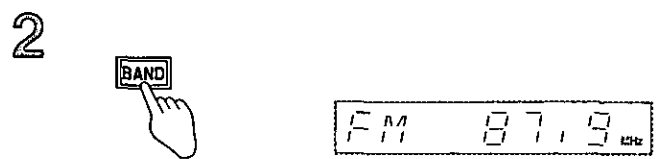
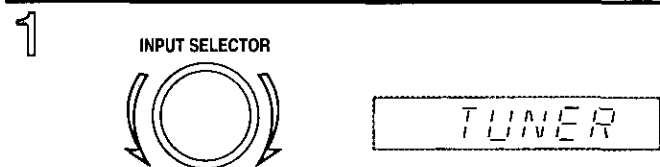

## B Direct tuning

- 1 Press [TUNER/BAND].  
The band changes each time you press the button.
- 2 Press [DIRECT TUNING/DISC ENTER].
- 3 Press the numbered buttons to enter the frequency.

e.g. To select 107.9 MHz, press [1] → [0] → [7] → [9]

Tuning intervals: FM – 0.1 MHz  
AM – 10 kHz

### Note

1. If you do not press a button while the cursor is flashing, the display returns to the frequency being received.
2. If the frequency has not been input correctly, "ERROR" will be displayed.

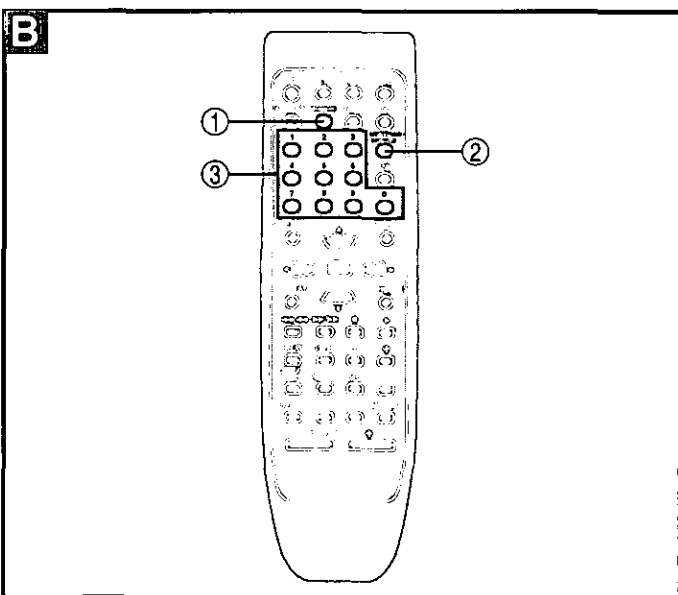

## The radio

### Preset tuning

Choose either automatic presetting, which presets the stations the tuner can receive, or manual presetting, which allows you to select the stations to preset and the order in which they are to be preset. There are 30 channels available for presetting.

#### Remember

If a new station is preset into a channel, the old station is erased.

#### A Automatic presetting

##### Presetting FM stations

Preparation: Tune to the FM frequency where you want to begin presetting (⇒ page 20).

##### Press and hold [MEMORY].

The FM stations the unit can receive are preset in channels 1 to 30.

##### Presetting AM stations

Preparation: Tune to the AM frequency where you want presetting to begin (⇒ page 20).

##### Press and hold [MEMORY].

The AM stations the unit can receive are preset in channels 21 to 30. (FM stations are replaced if any were preset in these channels.)

During automatic presetting, the memory indicator flashes and the frequency scrolls. The memory indicator and channel numbers are displayed for a second when a station is preset (E). The last station to be preset is displayed when presetting finishes.

#### For your reference

Even if the power supply cord is disconnected from the household AC outlet, the stations remain in memory for approximately one month.

#### C Manual presetting

Preset the stations one at a time.

- ① Tune to the station.
- ② Press [MEMORY].
- ③ Press [TUNING ∨ or ∧] to select a channel.
- ④ Press [MEMORY].

#### D Selecting channels

##### 1 Press [PRESET].

The channel number flashes for about 5 seconds.

##### 2 Press [TUNING ∨ or ∧].

Hold down the buttons to change channels faster.

#### On the remote control

Press [CH ∨ or ∧].

or

Press the numbered buttons.

For channels 1 to 9, press the corresponding number.

For channels 10 or over, press [≥10], then the two digits.

e.g. To select channel 21 [≥10] → [2] → [1]

MEMORY

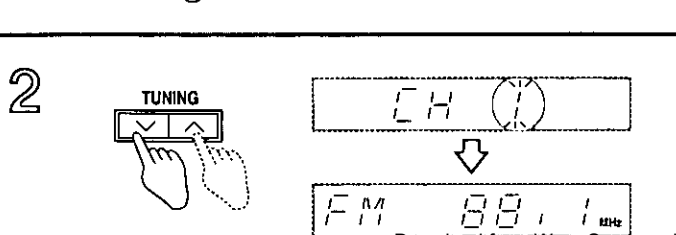
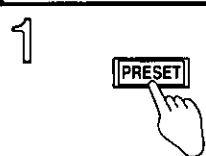
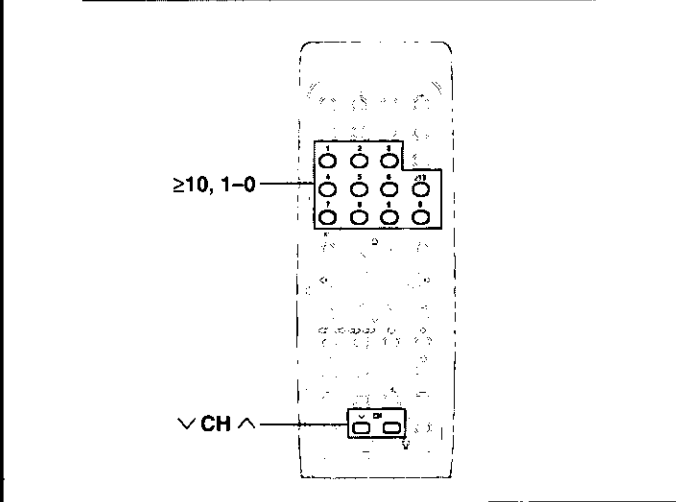
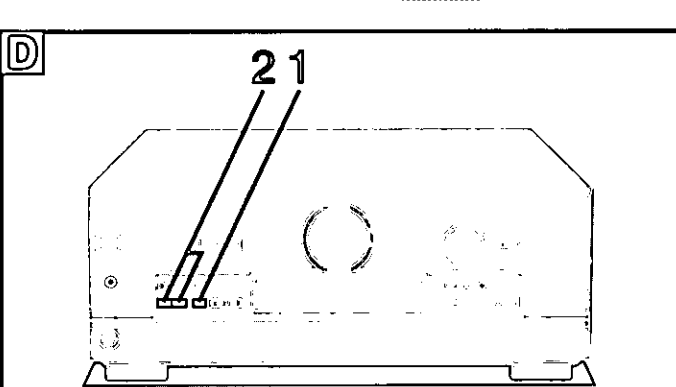
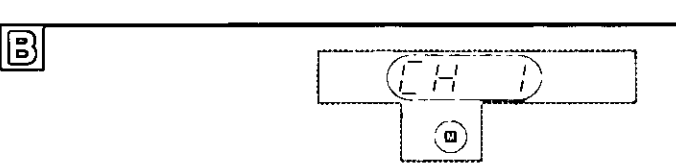
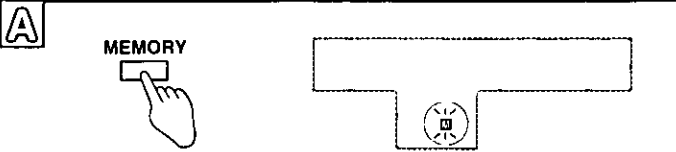
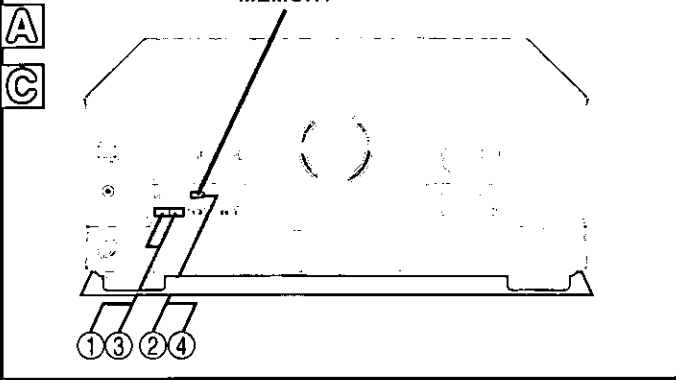

# Making a recording

## Note

You cannot record a source connected through a digital terminal. When recording CD, DVD, or TV, ensure the source is connected through the corresponding analog terminals (⇒ pages 6 and 7) and "ANALOG" input is selected (⇒ page 17).

## A Recording on a tape deck or VCR

You can record to a tape deck connected to TAPE REC (OUT) or to a VCR connected to VCR OUT.

See the recording unit's operating instructions for details on how to prepare it for recording.

When recording with a tape deck, you can record any source except TAPE.

When recording with a VCR, you can record any source except TAPE or VCR.

**1 Turn [INPUT SELECTOR] to select the source to be recorded.**

**2 Begin recording.**

Follow your recording unit's operating instructions.

**3 Begin the source to be recorded.**

Follow your equipment's operating instructions.

## B To monitor sound being recorded onto a tape deck

It is possible to check the sound being recorded if your tape deck is a 3 head system.

**Press [TAPE MONITOR] on this unit and set the monitor button on the tape deck to "TAPE".**

Press [TAPE MONITOR] once again to turn it off.

## C The HELP function

If you make a mistake in operation or if sound output stops, the HELP function displays information that indicates how you can remedy the situation.

If "ERROR" or scrolling characters ("SPEAKER OFF NOW", for example) appear on the display, do the following.

**Press [-HELP, -RESET].**

The remedy for the situation is displayed.

### For your reference

You can reset the unit's settings to the factory settings. If this is ever necessary, press and hold [-HELP, -RESET] for about 2 seconds until "RESET" is displayed.

This will not erase radio stations you have preset.

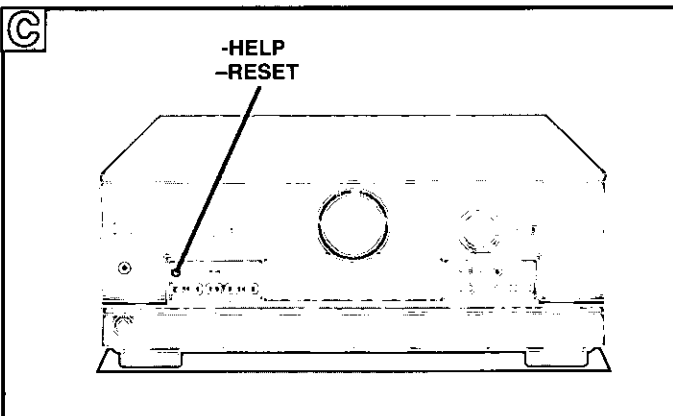
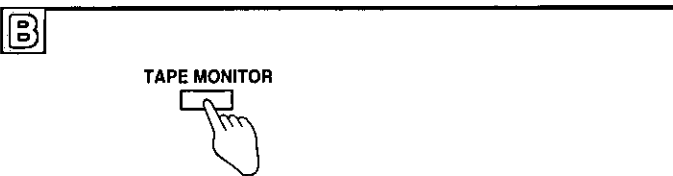
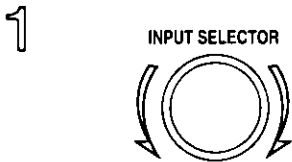
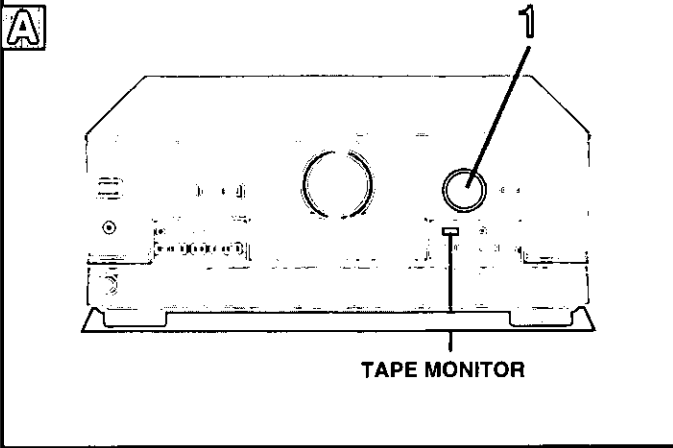

# Specifications (IHF'78)

## □ AMPLIFIER SECTION

<b>Rated minimum sine wave RMS power output</b>	
40 Hz–20 kHz both channels driven	
0.9 % total harmonic distortion	100 W per channel (6 Ω)
1 kHz continuous power output both channels driven	
0.05 % total harmonic distortion	105 W per channel (6 Ω)
<b>Total harmonic distortion</b>	
rated power at 40 Hz–20 kHz	0.9 % (6 Ω)
half power at 1 kHz	0.07 % (6 Ω)
<b>Power output at 1 kHz each channel driven</b>	
0.9 % total harmonic distortion	
Front	2 x 100 W (6 Ω)
Center	100 W (6 Ω)
Surround	2 x 100 W (6 Ω)
<b>Low frequency damping factor</b>	30 (6 Ω)
<b>Load impedance</b>	
Front	6–8 Ω
Center	6–8 Ω
Surround	6–8 Ω
<b>Dynamic headroom</b>	2 dB (6 Ω)
<b>Frequency response</b>	
CD, TAPE, DVD, TV, VCR	10 Hz–70 kHz, ±3 dB
<b>Input sensitivity</b>	
CD, TAPE, DVD, TV, VCR	27 mV (200 mV, IHF '66)
<b>S/N (IHF A)</b>	
CD, TAPE, DVD, TV, VCR	75 dB
<b>Input impedance</b>	
CD, TAPE, DVD, TV, VCR	22 kΩ
<b>Tone controls</b>	
BASS	50 Hz, +10 to –10 dB
TREBLE	20 kHz, +10 to –10 dB
<b>Subwoofer frequency response (–6 dB)</b>	7–200 Hz

Digital input	
Optical	2
Coaxial	1

## □ FM TUNER SECTION

<b>Frequency range</b>	87.9–107.9 MHz
<b>Sensitivity</b>	11.2 dBf (2 μV, IHF '58)
<b>50 dB quieting sensitivity</b>	
MONO	18.3 dBf (4.5 μV, IHF '58)
STEREO	38.3 dBf (45 μV, IHF '58)
<b>Total harmonic distortion</b>	
MONO	0.2 %
STEREO	0.3 %
<b>S/N</b>	
MONO	73 dB
STEREO	67 dB
<b>Frequency response</b>	20 Hz–15 kHz, +1 dB, –2 dB
<b>Alternate channel selectivity</b>	65 dB
<b>Capture ratio</b>	1.5 dB
<b>Image rejection at 98 MHz</b>	40 dB
<b>Spurious response rejection at 98 MHz</b>	75 dB
<b>AM suppression</b>	50 dB
<b>Stereo separation</b>	
1 kHz	40 dB
10 kHz	30 dB
<b>Antenna terminal</b>	75 Ω (unbalanced)

## □ AM TUNER SECTION

<b>Frequency range</b>	530–1710 kHz
<b>Sensitivity</b>	20 μV, 330 μV/m
<b>Selectivity</b>	55 dB
<b>IF rejection at 1000 kHz</b>	50 dB

## □ VIDEO SECTION

<b>Output voltage at 1 V input (unbalanced)</b>	1±0.1 Vp-p
<b>Maximum input voltage</b>	1.5 Vp-p
<b>Input/output impedance</b>	75 Ω

## □ GENERAL

<b>Power supply</b>	AC 120 V, 60 Hz
<b>Power consumption</b>	410 VA, 320 W
<b>Dimensions (W x H x D)</b>	430 x 158 x 367 mm (16-15/16" x 6-7/32" x 14-15/32")
<b>Mass</b>	9.1 kg (20.1 lb.)

<b>Power consumption in standby mode:</b>	1 W
---	-----

### Notes:

- Specifications are subject to change without notice. Mass and dimensions are approximate.
- Total harmonic distortion is measured by the digital spectrum analyzer.

## Maintenance

### If the surfaces are dirty

To clean this unit, wipe with a soft, dry cloth.  
If the surfaces are extremely dirty, use a soft cloth dipped in a soap-and-water solution or a weak detergent solution.

- Never use alcohol, paint thinner or benzine to clean this unit.
- Before using chemically treated cloth, read the instructions that came with the cloth carefully.

## Product Service

Do not attempt to remove the cover (s) or repair the unit yourself. Refer servicing to qualified personnel only.







### Product information



For product service, product information or assistance with product operation, refer to the servicenter directory.

# Troubleshooting guide

Before requesting service, make the checks below. If you can't fix the system as described below, or if something not listed here occurs, refer to the enclosed directory to locate an Authorized Service Center convenient to you or contact your dealer.

For detailed instructions, contact an authorized servicenter in the U.S.A. and Panasonic Canada Inc. Customer Care Centre in Canada. In the U.S.A., call 1-800-211-7262 or visit [www.panasonic.com](http://www.panasonic.com)  
In Canada, call 905-624-5505 or visit [www.panasonic.ca](http://www.panasonic.ca)

Common problems		Ref. Pages
No power.		• Ensure the power cord is connected. 9
		• Turn the volume up. 17
No sound.		• Turn muting off. 19
		• Check connections to speakers and other equipment. 6-11
		• Turn on the speakers. 17
		• Turn off the tape monitor. 19
		• Select the correct source. 17
		• Change the DIGITAL input setting to suit the type of connection you have made. 12-13
Cannot select "DIGITAL" input.		• Check that the digital signals can be decoded by this unit. 15
		• Turn PCM FIX off. 15
Sound stops. "OVERLOAD" appears on the display.		• Cancel "DSP DEFEAT". 20
		• Switch off the unit, determine and correct the cause, then switch the unit on. Causes include shorting of the positive and negative speaker wires, using speakers with an impedance lower than rated for this unit, straining of the speakers through excessive volume or power, and using the unit in a hot environment. -
"F 70" appears on the display.		• Use speakers with the right impedance rating. 10-11
		• Turn the unit off, disconnect the AC power supply cord, then reconnect and turn the unit on. Consult your dealer if "F 70" remains on the display. -
The picture doesn't appear on the television.		• Change the television's input mode to suit the connections between this unit and the television. -

DSP sound modes		Ref. Pages
Sound is not heard from the center, surround, or subwoofer speakers.		• Ensure the size settings for your speakers are correct. 12-13
		• Check the DSP sound mode. 15-16
		• Cancel "DSP DEFEAT". 20
DSP sound modes cannot be selected.		• Cancel "DSP DEFEAT". 20

Radio		Ref. Pages
The radio cannot be tuned in or there is a lot of noise and interference.		• Adjust the position of the FM or AM antenna. 8
		• Reduce the treble. 18
		• Select "DSP DEFEAT". 20
		• Turn off nearby televisions, video decks, DVD players, and satellite receivers. 20
		• You may need an outdoor antenna or an antenna with more elements. 8
		• Separate the antenna from other cables, leads, and appliances. -



# Servicenter List (U.S.A.)

**Panasonic**

**Technics**

**Quasar**

**For Product Information, Operating Assistance, Literature Request, Dealer Locations, and all Customer Service inquiries please contact:  
1-800-211-PANA (7262), Monday-Friday 9 am-9pm; Saturday-Sunday 9 am-7pm, EST.**

**Web Site: <http://www.panasonic.com>  
You can purchase parts, accessories or locate your nearest servicenter by visiting our Web Site.**

### Accessory Purchases:

1-800-332-5368 (Customer Orders Only)  
Panasonic Services Company 2042184th Avenue South, Kent, WA 98032  
(6 am to 5 pm Monday-Friday; 6 am to 10:30 am Saturday; PST)  
(Visa, MasterCard, Discover Card, American Express, Check)

### Factory Servicenters Locations

#### CALIFORNIA

6550 Katella Avenue  
Cypress, CA 90630

800 Dubuque Avenue  
S. San Francisco  
CA 94080

20201 Sherman Way  
Suite 102  
Canoga Park, CA 91306

3878 Ruffin Road  
Suite A  
San Diego, CA 92123

#### COLORADO

1640 South Abilene Street  
Suite D  
Aurora, CO 80012

#### FLORIDA

3700 North 29<sup>th</sup> Avenue  
Suite 102  
Hollywood, FL 33020

#### GEORGIA

8655 Roswell Road  
Suite 100  
Atlanta, GA 30350

#### ILLINOIS

9060 Golf Road  
Niles, IL 60714

1703 North Randall Road  
Elgin, IL 60123  
(Pick-up/Drop-off only)

#### MARYLAND

62 Mountain Road  
Glen Burnie, MD 21061

#### MASSACHUSETTS

60 Glacier Drive  
Suite G  
Westwood, MA 02090

#### MICHIGAN

37048 Van Dyke Avenue  
Sterling Heights, MI 48312

#### MINNESOTA

7850-12<sup>th</sup> Avenue South  
Airport Business Center  
Bloomington, MN 55425

#### OHIO

2236 Waycross Road  
Civic Center Plaza  
Forest Park, OH 45240

#### PENNSYLVANIA

2221 Cabot Blvd. West  
Suite B  
Langhorne, PA 19047

#### TEXAS

13615 Welch Road  
Suite 101  
Farmers Branch  
TX 75244

#### WASHINGTON

20425-84<sup>th</sup> Avenue South  
Kent, WA 98032

#### HAWAII

99-859 Iwaiwa Street  
Aiea, Hawaii 96701  
Phone (808) 488-1996  
Fax (808) 486-4369

### Service in Puerto Rico

**Matsushita Electric of Puerto Rico, Inc. Panasonic Sales Company/Factory Servicenter:  
Ave. 65 de Infantería, Km. 9.5, San Gabriel Industrial Park, Carolina, Puerto Rico 00985  
Phone (787) 750-4300 Fax (787) 768-2910**

F04030 As of APR '00

Reference

# Warranty (U.S.A.)

Panasonic Consumer Electronics Company,  
Division of Matsushita Electric Corporation  
of America  
One Panasonic Way,  
Secaucus, New Jersey 07094

Panasonic Sales Company, Division of Matsushita Electric  
Corporation of Puerto Rico, Inc.  
Ave. 65 de Infantería, Km. 9.5, San Gabriel Industrial  
Park, Carolina, Puerto Rico 00985

## Panasonic/Technics Audio Products Limited Warranty

Panasonic Consumer Electronics Company or Panasonic Sales Company (collectively referred to as "the warrantor") will repair this product with new or refurbished parts in the event of a defect in materials or workmanship, free of charge, in the U.S.A. or Puerto Rico as follows (all time periods start from the date of original purchase):

COMPACT DISC PLAYERS, DIGITAL VERSATILE DISC PLAYERS, RADIOS, RADIO CASSETTE PLAYERS/RECORDERS (with and without CD Players), CASSETTE RECORDERS, MICROCASSETTE RECORDERS/TRANSCRIBERS, IC RECORDERS, RECEIVERS, TUNERS, AMPLIFIERS, SUBWOOFER AMPLIFIERS, TURNTABLES, CASSETTE DECKS, AUDIO PROCESSORS, EQUALIZERS, AUDIO MIXERS, REMOTE CONTROLS, HOME THEATER SYSTEMS (receiver/amplifiers, speakers), RACK SYSTEMS (receivers, tuners, amplifiers, cassette decks, CD players, equalizers, rack system speakers, EXCLUDING: audio racks)—labor and parts for one (1) year.

ALL AUDIO RACKS (cabinets)—parts only 30 days.

TECHNICS STAND ALONE SPEAKERS, SUBWOOFER SPEAKERS—labor and parts for three (3) years.

ACCESSORIES—HEADPHONES, CARTRIDGES, MICROPHONES, ADAPTERS—labor and parts for ninety (90) days.

BATTERIES—(when applicable)—New rechargeable batteries in exchange for defective rechargeable batteries for ten (10) days. Non-rechargeable batteries are not warranted.

RECHARGEABLE BATTERY PACKS—(when applicable)—New rechargeable battery packs in exchange for defective rechargeable battery packs for ninety (90) days. Non-rechargeable battery packs are not warranted.

Carry-in or mail-in service in the U.S.A. can be obtained during the warranty period by contacting a Panasonic Services Company (PASC) Factory Servicenter listed in the Servicenter Directory. Or call toll free, 1-800-211-7262 to locate a PASC authorized Servicenter. Carry-in or mail-in service in Puerto Rico can be obtained during the warranty period by calling the Panasonic Sales Company telephone number listed in the Servicenter Directory.

This warranty is extended only to the original purchaser. A purchase receipt or other proof of date of original purchase will be required before warranty service is rendered.

This warranty only covers failures due to defects in materials and workmanship which occur during normal use and does not cover normal wear to the stylus (when applicable) or a dealer installed cartridge or stylus. The warranty does not cover damages which occur in shipment or failures which are caused by products not supplied by the warrantor, or failures which result from accident, misuse, abuse, neglect, mishandling, faulty installation, misapplication, set-up adjustments, maladjustment of consumer controls, improper operation or maintenance, improper antenna, inadequate signal reception or pick-up, alteration, modification, power line surge, improper voltage supply, lightning damage, commercial use, such as; hotel, office, restaurant, or other business or rental use of the product, or service by anyone other than a PASC Factory Servicenter or a PASC authorized Servicenter, or damage that is attributable to acts of God.

### LIMITS AND EXCLUSIONS

There are no express warranties except as listed above.

THE WARRANTOR SHALL NOT BE LIABLE FOR INCIDENTAL OR CONSEQUENTIAL DAMAGES RESULTING FROM THE USE OF THIS PRODUCT, OR ARISING OUT OF ANY BREACH OF THIS WARRANTY, INCLUDING WITHOUT LIMITATION, DAMAGE TO TAPES, RECORDS OR DISCS. ALL EXPRESS AND IMPLIED WARRANTIES, INCLUDING THE WARRANTIES OF MERCHANTABILITY, AND FITNESS FOR A PARTICULAR PURPOSE, ARE LIMITED TO THE APPLICABLE WARRANTY PERIOD SET FORTH ABOVE. Some states do not allow the exclusion or limitation of incidental or consequential damages, or limitations on how long an implied warranty lasts, so the above exclusions or limitations may not apply to you.

This warranty gives you specific legal rights and you may also have other rights which vary from state to state.

If a problem with this product develops during or after the warranty period, you may contact your dealer or Servicenter. If the problem is not handled to your satisfaction, then write to the Consumer Affairs Department at the company address indicated above.

### If you ship the product

Carefully pack and send it prepaid, adequately insured and preferably in the original carton. Attach a postage-affixed letter, detailing the complaint, to the outside of the carton.

*Do NOT send the product to the Executive or Regional Sales offices. They are NOT equipped to make repairs.*

### Customer's Record

Model No. _____	Dealer's Name _____
Serial No. _____ or _____	_____
Code No. _____	Dealer's Address _____
Date of Purchase _____	_____

MEMO

Reference



---

**Panasonic Consumer Electronics  
Company, Division of Matsushita  
Electric Corporation of America**  
One Panasonic Way Secaucus,  
New Jersey 07094  
<http://www.panasonic.com>

**Panasonic Sales Company,  
Division of Matsushita Electric of  
Puerto Rico, Inc. ("PSC")**  
Ave. 65 de Infantería, Km. 9.5  
San Gabriel Industrial Park, Carolina,  
Puerto Rico 00985

**Panasonic Canada Inc.**  
5770 Ambler Drive  
Mississauga, Ontario  
L4W 2T3  
[www.panasonic.ca](http://www.panasonic.ca)



## Free Manuals Download Website

<http://myh66.com>

<http://usermanuals.us>

<http://www.somanuals.com>

<http://www.4manuals.cc>

<http://www.manual-lib.com>

<http://www.404manual.com>

<http://www.luxmanual.com>

<http://aubethermostatmanual.com>

Golf course search by state

<http://golfingnear.com>

Email search by domain

<http://emailbydomain.com>

Auto manuals search

<http://auto.somanuals.com>

TV manuals search

<http://tv.somanuals.com>