

# Technics®

AV Control Stereo Receiver

SA-EX700

SA-EX500

Operating Instructions

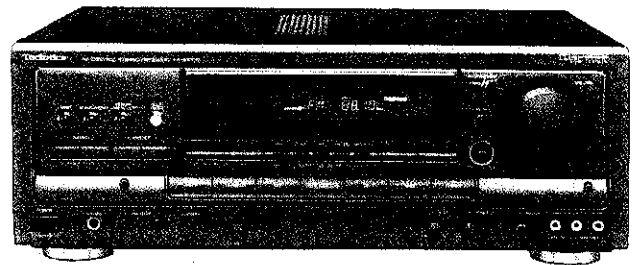

The photographs show SA-EX700.

Before connecting, operating or adjusting this product, please read these instructions completely.

GN

RQT3616-L

# Dear Customer

Thank you for purchasing this Technics product.  
For optimum performance and safety, please read these instructions carefully.

These operating instructions are applicable to models SA-EX700 and SA-EX500.

These operating instructions, however, are intended primarily for model SA-EX700.

THIS TUNER/RECEIVER IS CAPABLE OF RECEIVING THE NEW AM STEREO BROADCASTS FROM THE AM BAND RADIO STATIONS. HOWEVER LIKE MANY TUNERS AND RECEIVERS CURRENTLY AVAILABLE ON THE MARKET IT WILL REPRODUCE THIS AM STEREO SIGNAL ONLY IN AM MONO, WHICH, IN EFFECT, IS OF NO LESSER QUALITY THAN YOUR EXISTING AM MONO TUNER/RECEIVER.



## Table of contents

<b>Accessories</b> .....	<b>2</b>
<b>Suggestions for safety</b> .....	<b>3</b>
<b>Front panel controls</b> .....	<b>4</b>
<b>Equipment connections</b> .....	<b>5</b>
<b>Antenna connections</b> .....	<b>8</b>
<b>Speaker connections</b> .....	<b>10</b>
<hr/>	
<b>Basic operations</b> .....	<b>12</b>
To adjust the tone quality .....	13
To adjust the sound balance .....	13
To mute the sound level .....	13
To emphasize low frequency sound	
<b>SA-EX700 only</b> .....	13
Switching between the "TV" terminals (rear side)	
and "VCR 2" terminals (front side) <b>SA-EX700 only</b> .....	13
To listen through headphones .....	13
<b>Listening to radio broadcasts</b> .....	<b>14</b>
Sequential tuning .....	14
Preset tuning .....	14
Direct access tuning .....	16
<b>Enjoying sound with DOLBY PRO LOGIC</b> .....	<b>17</b>
SURROUND .....	17
3 STEREO .....	17
Setting the center mode .....	17
Adjusting speaker output level .....	18
Adjusting the delay time <b>SA-EX700 only</b> .....	19
Enjoying with SURROUND or 3 STEREO .....	20
<b>Enjoying sound with SFC</b> .....	<b>20</b>
Adjusting field of sound .....	21
<b>Making a recording</b> .....	<b>22</b>
Recording on the tape deck .....	22
Recording on the VCR (VCR 1) .....	22
<b>Sleep timer function</b> .....	<b>24</b>
<b>About the HELP function</b> .....	<b>24</b>
<hr/>	
<b>Troubleshooting guide</b> .....	<b>25</b>
<b>Technical specifications</b> .....	<b>26</b>

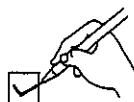
## Accessories

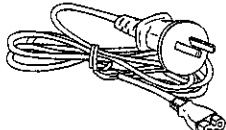
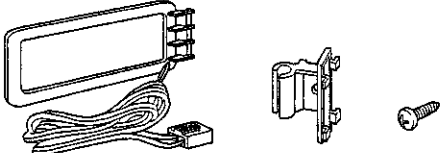
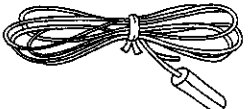
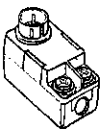

Please check and identify the supplied accessories

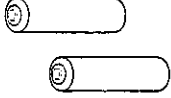
<input type="checkbox"/>	AC power supply cord.....	1 pc.
		
<input type="checkbox"/>	AM loop antenna set (RSA0010)	
	• AM loop antenna .....	1 pc.
	• AM loop antenna holder .....	1 pc.
	• Screw .....	1 pc.
		
<input type="checkbox"/>	FM indoor antenna.....	1 pc.
		
<input type="checkbox"/>	Antenna plug.....	1 pc.
		
<input type="checkbox"/>	Remote control transmitter (RAK-SA612WH).....	1 pc.
		
For details on remote control transmitter operation, refer to "How to use the remote control transmitter" in the separate booklet.		
<input type="checkbox"/>	Batteries.....	2 pcs.
		

# Suggestions for safety

## Placement

Avoid placing the unit in areas of:

- direct sunlight
  - high temperature
  - high humidity
  - excessive vibration
  - uneven surfaces (Place the unit on a flat level surface.)
- Such conditions might damage the cabinet and/or other component parts and thereby shorten the unit's service life.

## Ventilation

- Place the unit in a well ventilated position at least 10 cms away from wall surfaces etc.
- Ensure that curtains and similar materials do not obstruct the ventilation holes.

## Stacking

Never place heavy items on top of the unit or the power cord.

## Voltage

- It is very dangerous to use an AC power source of high voltage such as for an air conditioner.  
A fire might be caused by such a connection.
- A DC power source can not be used.  
Be sure to check the power source carefully, especially on a ship or other place where DC is used.

## Power cord protection

- Avoid cuts, scratches or poor connection of the AC mains cord, as this may result in fire or electric shock hazard.  
Excessive bending, pulling or slicing of the cord should also be avoided.
- Do not pull on the cord when you are disconnecting the power, as this could cause an electric shock. Grasp the plug firmly when you disconnect the power supply.
- Never touch the plug with wet hands or a serious electric shock could result.

## Foreign materials

- Ensure that no foreign objects, such as needles, coins, screw-drivers etc., accidentally fall into the unit or through the ventilation holes.  
Otherwise, a serious electric shock or malfunction could occur.
- Be extremely careful about spilling water or liquid on/into the unit, as a fire or electric shock could occur.  
(Disconnect the power plug and contact your dealer immediately if this occurs.)
- Avoid spraying insecticides onto the unit as they contain flammable gases which can be ignited.
- Insecticides, alcohol, paint thinner and similar chemicals should never be used to clean the unit as they can cause flaking or cloudiness to the cabinet finish.

## Maintenance

Clean the cabinet, panel and controls with a soft cloth lightly moistened with mild detergent solution.

Do not use any type of abrasive pad, scouring powder or solvent such as alcohol or benzene.

## Service

- Never attempt to repair, disassemble or reconstruct the unit if there seems to be a problem.  
A serious electric shock could result if you ignore this precautionary measure.
- If a problem occurs during operation (the sound is interrupted, indicators fail to illuminate, smoke is detected, etc) contact your dealer or Authorized Service Center immediately.
- Disconnect the power supply if the unit will not be used for a long time. Otherwise the operation life could be shortened.

### CAUTION

Do not place a tape deck or CD player on top of this unit. Heat radiated from the top of this unit may cause damage to the tape or CD software.

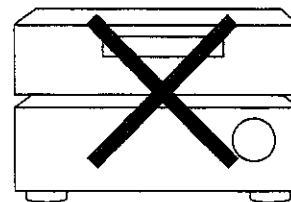

**NO**

### CAUTION!

**DO NOT INSTALL OR PLACE THIS UNIT IN A BOOKCASE, BUILT IN CABINET OR IN ANOTHER CONFINED SPACE IN ORDER TO KEEP WELL VENTILATED CONDITION. ENSURE THAT CURTAINS AND ANY OTHER MATERIALS DO NOT OBSTRUCT THE VENTILATION CONDITION TO PREVENT RISK OF ELECTRIC SHOCK OR FIRE HAZARD DUE TO OVERHEATING.**

# Front panel controls

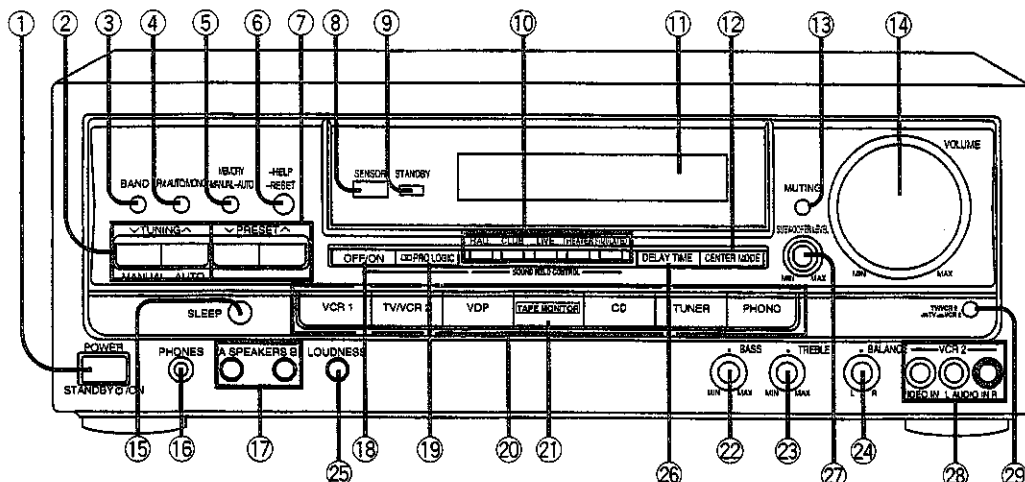

No.	Name	Ref. page
①	Power "STANDBY  /ON" switch (POWER, STANDBY  /ON) Press to switch the unit from on to standby mode or vice versa. In standby mode, the unit is still consuming a small amount of power.	12
②	Tuning buttons (TUNING)	14
③	Band select button (BAND)	14
④	FM mode select button (FM AUTO/MONO)	14
⑤	Memory button (MEMORY)	15
⑥	Help/reset button (-HELP -RESET)	24
⑦	Preset channel buttons (PRESET)	15,16
⑧	Remote control signal sensor (SENSOR)	-
⑨	"STANDBY" indicator (STANDBY) When the unit is connected to the AC mains supply, this indicator lights up in standby mode and goes out when the unit is turned on.	-
⑩	Sound field control select buttons	21
⑪	Display	-
⑫	Center mode select button (CENTER MODE)	17
⑬	Muting button (MUTING)	13
⑭	Volume control (VOLUME)	12

No.	Name	Ref. page
⑮	Sleep timer button (SLEEP)	24
⑯	Headphones jack (PHONES)	13
⑰	<b>For SA-EX700</b> Speaker buttons (SPEAKERS A, B) <b>For SA-EX500</b> Speaker button (SPEAKERS)	12
⑱	DOLBY PRO LOGIC/SFC ON button (OFF/ON)	17,20
⑲	DOLBY PRO LOGIC mode select button ( PRO LOGIC)	17,20
⑳	Input select buttons <b>For SA-EX700</b> VCR 1, TV/VCR 2, VDP, TAPE MONITOR, CD, TUNER, PHONO <b>For SA-EX500</b> VCR, TV/VCR 2, TAPE MONITOR, CD, TUNER, PHONO	12
㉑	Tape monitor button (TAPE MONITOR)	12,22
㉒	Bass control (BASS)	13
㉓	Treble control (TREBLE)	13
㉔	Balance control (BALANCE)	13
<b>SA-EX700 only</b>		
㉕	Loudness button (LOUDNESS)	13
㉖	Delay time adjust button (DELAY TIME)	19,21
㉗	Subwoofer level control (SUBWOOFER LEVEL)	12
㉘	VCR 2 front input terminals (VCR 2)	13,23
㉙	TV/VCR 2 select button (TV/VCR 2)	13,23

# Equipment connections

## For SA-EX700

Make sure that the power supply for all components has been turned off before making any connections.

**Note:**

Do not place books, etc., on top of this unit or block the heat radiation vents in any way

**Stereo connection cable**  
(not included)



(L) White  
(R) Red

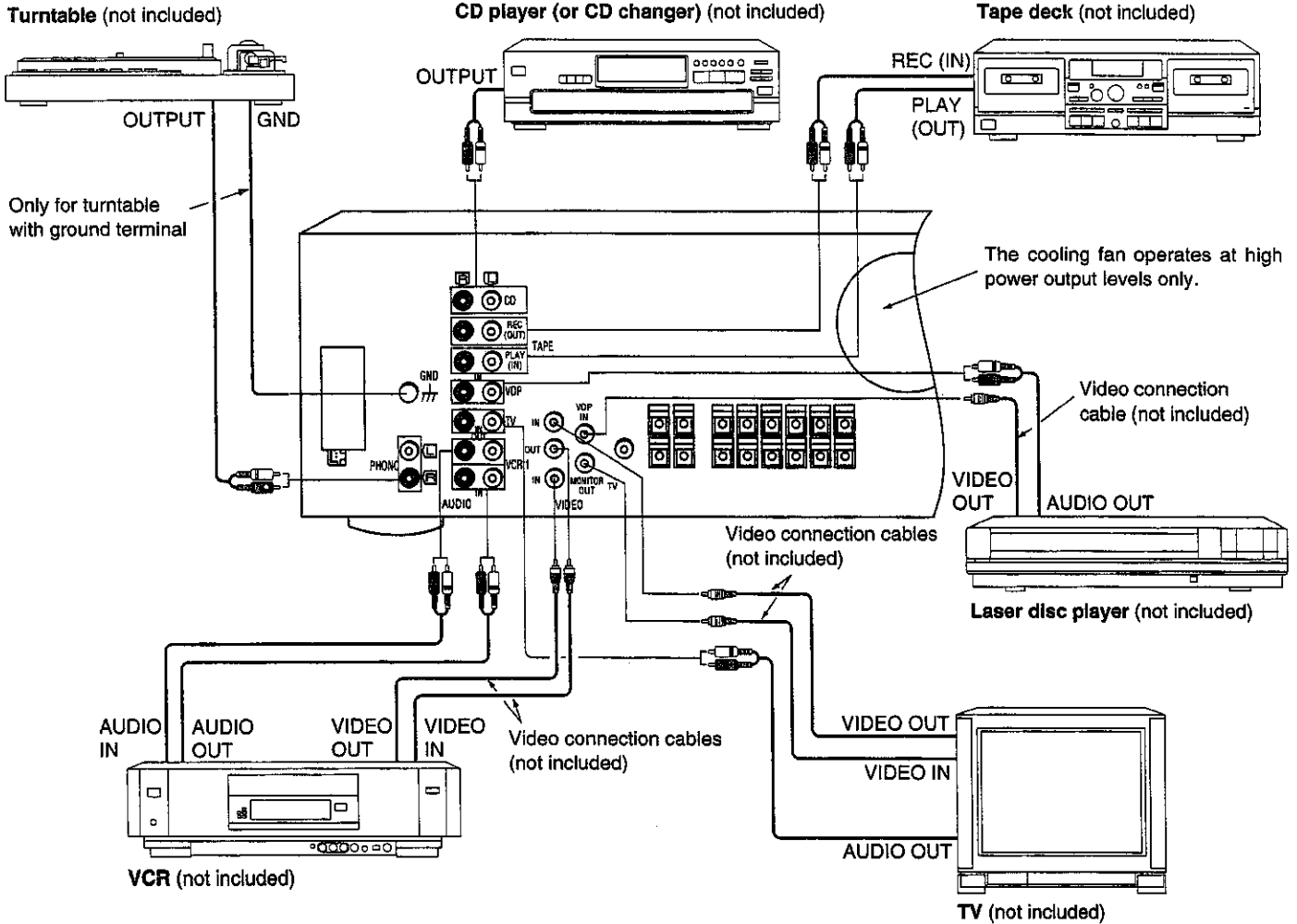

## To connect a video equipment with 21 pin terminal

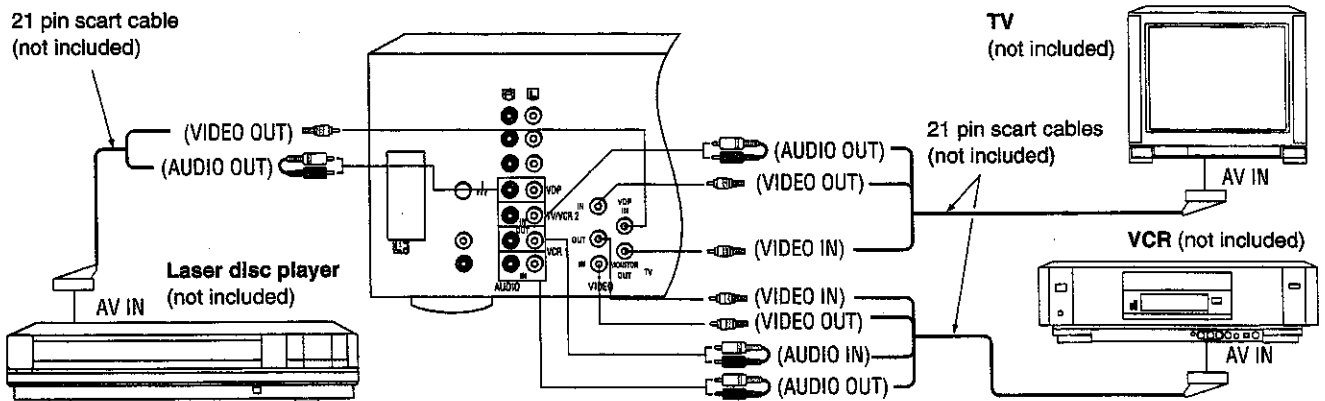

# Equipment connections

## For SA-EX500

Make sure that the power supply for all components has been turned off before making any connections.

**Note:**

Do not place books, etc., on top of this unit or block the heat radiation vents in any way

**Stereo connection cable** (not included)  
 (L) White  
 (R) Red

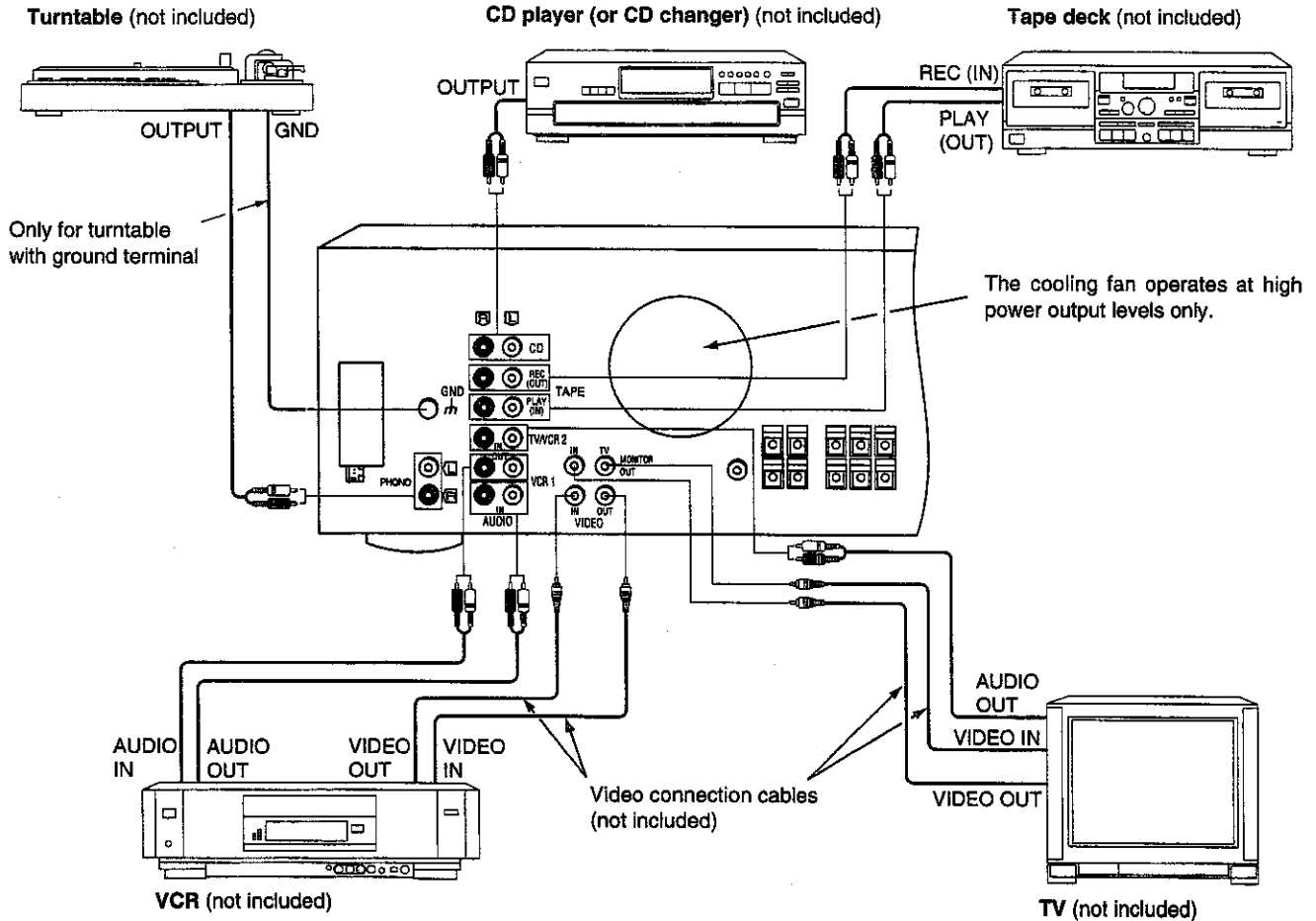

## To connect a video equipment with 21 pin terminal

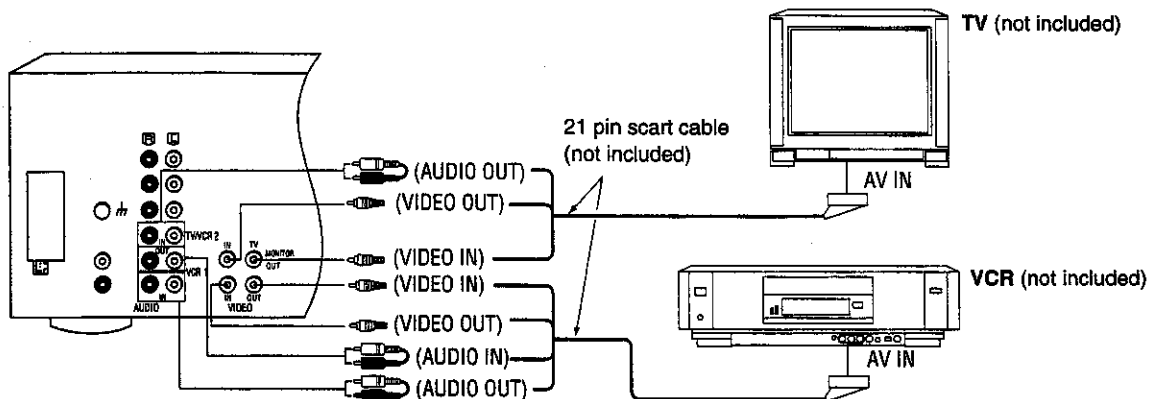

## To connect a second VCR

SA-EX500 only

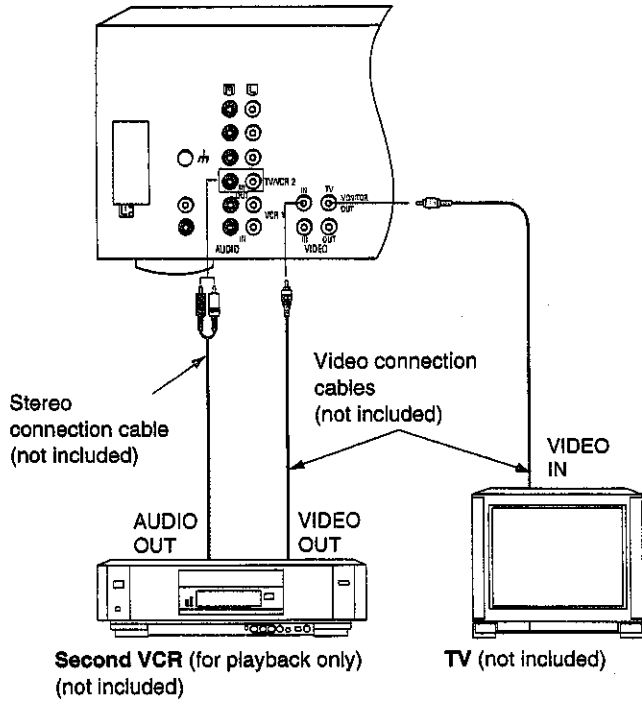

## AC power supply cord

Connect this cord after all other cables and cords are connected.

SA-EX700

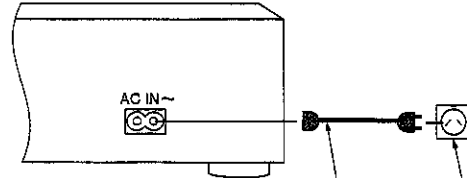

SA-EX500

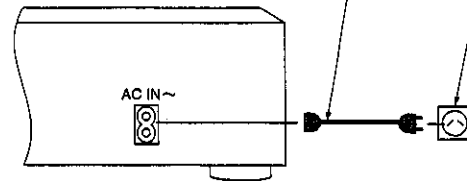

AC power supply cord (included)

Household AC outlet

# Antenna connections

## FM indoor antenna (included)

This antenna is normally sufficient for reception of FM broadcasts.

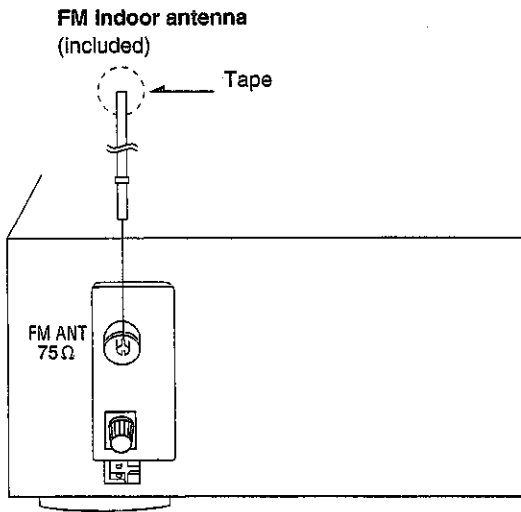

Attach to a wall (using a tack or tape) facing in the direction of best reception.

### For best reception sound quality

An FM outdoor antenna is recommended.

Disconnect the antenna if an FM outdoor antenna is installed.

## FM outdoor antenna (not included)

The outdoor antenna should be used when using the main unit in mountainous areas or in spaces enclosed by reinforced concrete where the FM indoor antenna (included) does not provide satisfactory reception.

### Note

An outdoor antenna should be installed by a qualified technician only.

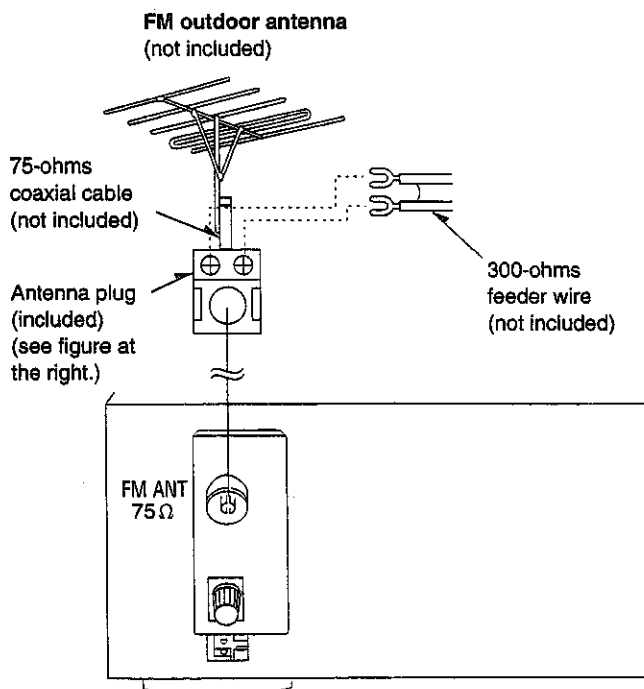

## How to use the antenna plug (included)

Two types of wire are most commonly used for connection from the antenna: 300-ohms parallel feeder wire or 75-ohms coaxial cable. For best resistance to outside interference, the use of 75-ohms coaxial cable is suggested.

### To connect a 75-ohms coaxial cable

- 1 Remove a piece of the outer vinyl insulator.



- 2 Remove the cover while pulling the tabs.

### Note

If the tabs are pulled too hard, the casing may be damaged.

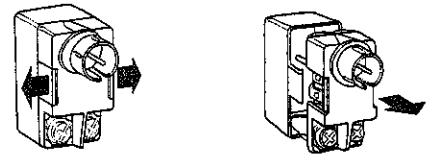

- 3 Remove the lead wire and clamp it with the plastic bar.

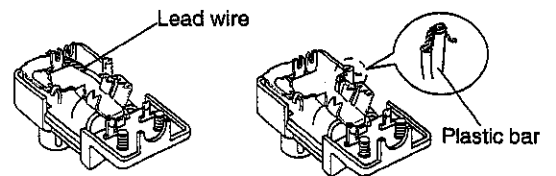

- 4 Install the coaxial cable.

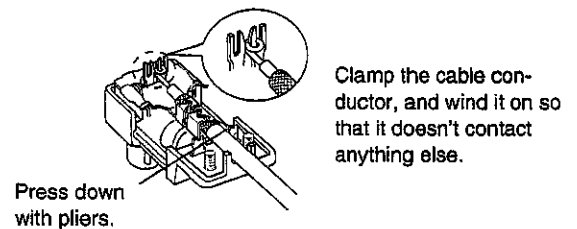

- 5 Attach the cover.

### To connect a 300-ohms feeder wire

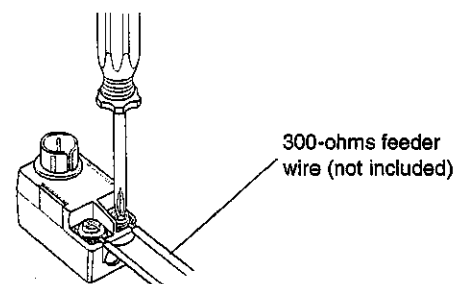

Loosen the screw to connect the feeder wire and tighten it to secure the connection.



## AM loop antenna (included)

This antenna is normally sufficient for reception of AM broadcasts.

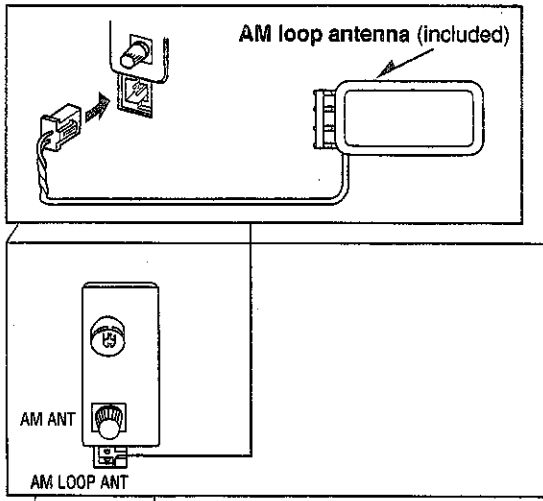

Install the AM loop antenna holder (included) at the rear panel of this unit and then attach the AM loop antenna to the AM loop antenna holder (facing in the direction of best reception).

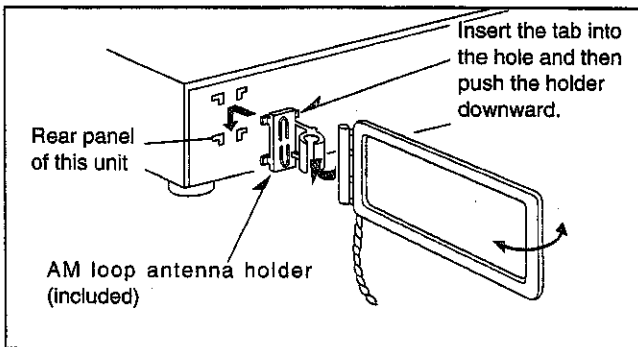

## When mounting the antenna to a column, a wall or rack

Mount it vertically.

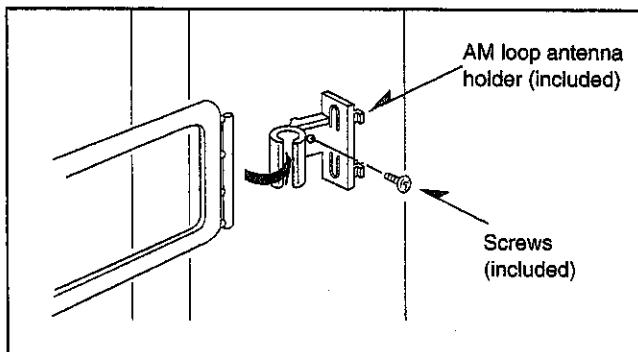

Pay attention to the following points when mounting the antenna.

- Do not mount it horizontally (doing so will impair reception).
- Do not mount it close to power supply cords, speaker wires or metal surfaces (doing so will result in noise).
- Do not mount it close to a tape deck. When the tape deck is being used, chirping or beeping sounds may result.

## AM outdoor antenna (not included)

The outdoor antenna should be used when using the main unit in mountainous areas or in spaces enclosed by reinforced concrete where the AM loop antenna (included) does not provide satisfactory reception.

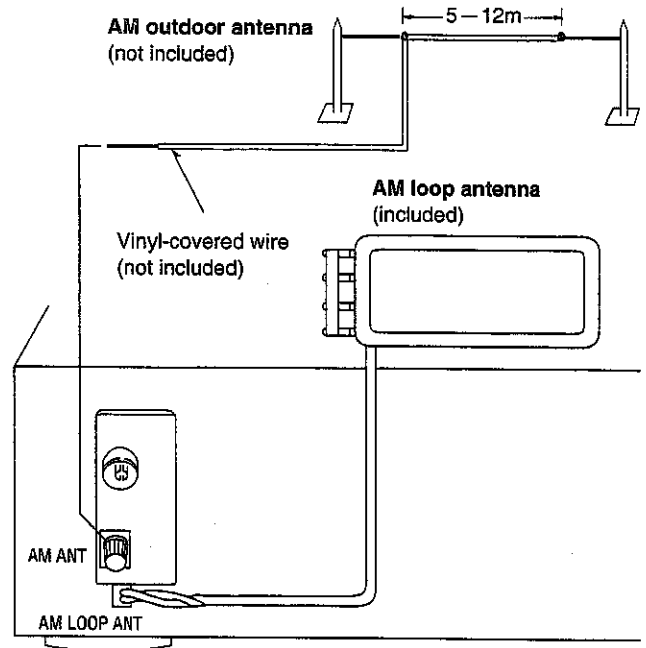

Stretch 5-12 m of vinyl-covered wire horizontally across a window frame or other convenient location, keeping it as high as possible from the ground.

When the unit is not in use, disconnect the outdoor antenna to prevent possible damage that may be caused by lightning. Never use an outdoor antenna during an electrical storm.

### Note

Be sure to connect the AM loop antenna even when an AM outdoor antenna is used.

# Speaker connections

## Placement of speakers

As well as enjoying normal stereo reproduction with the left and right front speakers, a center speaker and surround speakers can also be connected to this unit in order to enjoy the sound performance of Dolby Pro Logic Systems.

The illustration below shows where to place the speakers so as to best enjoy sound with Dolby Pro Logic systems.

We recommend that surround speakers be placed on the side of or slightly behind the listener, and about one meter higher than ear level.

However the position should be adjusted to your personal preference, because the effect varies to some degree depending upon the sources.

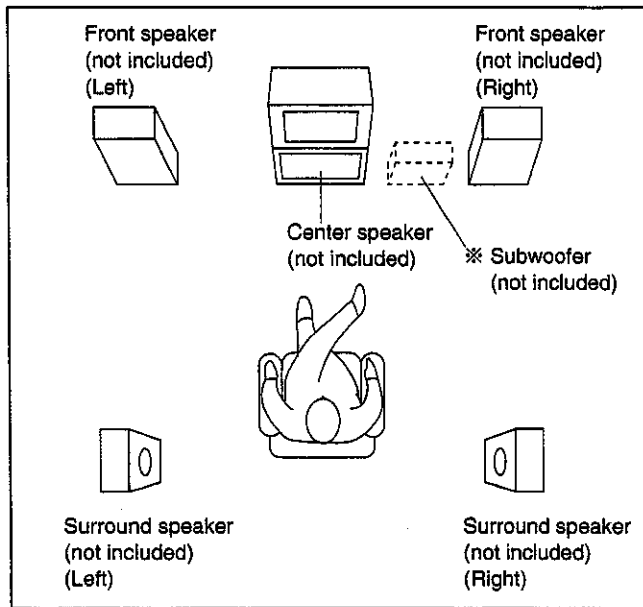

※ The subwoofer can be placed in any position.

### Connecting the speaker cords

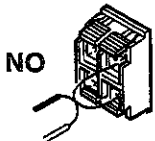
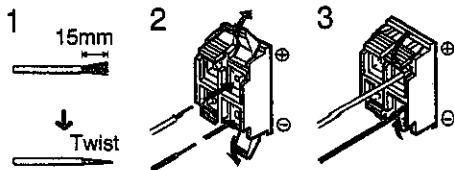

**Note**  
To prevent damage to circuitry, never short-circuit positive (+) and negative (-) speaker wires.

### Speaker impedance

Front speaker SA-EX700 A or B: 8-16 Ω  
A and B: 8-16 Ω

SA-EX500 : 8-16 Ω

Center speaker: 8-16 Ω  
Surround speaker: 4-16 Ω

## Connection of front speakers

SA-EX700

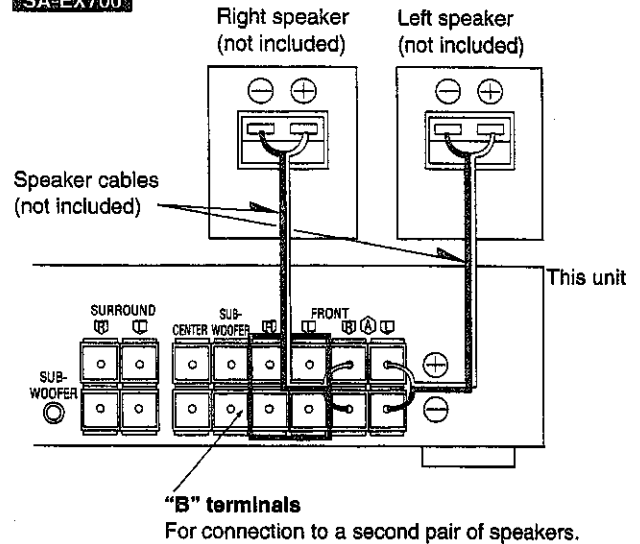

SA-EX500

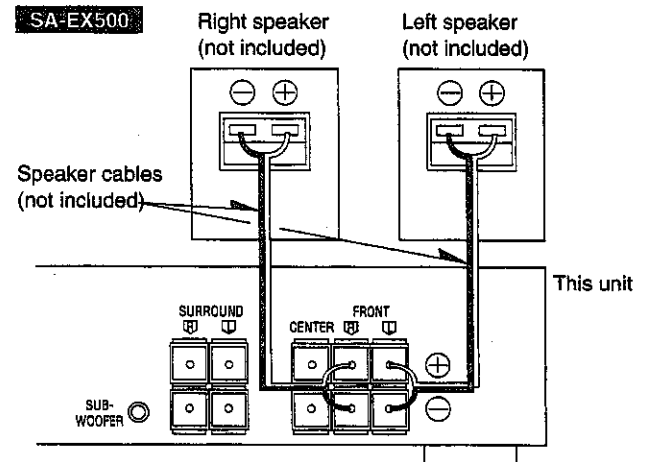

## Connection of center speaker

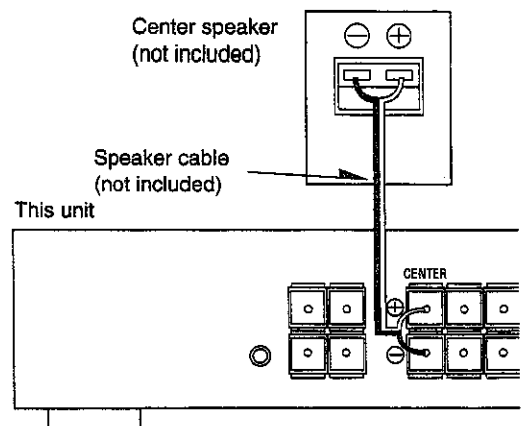

**Note**

Before sound can be heard, the SURROUND mode or 3 STEREO mode (of the Dolby Pro Logic system) must be on.

## Connection of surround speakers

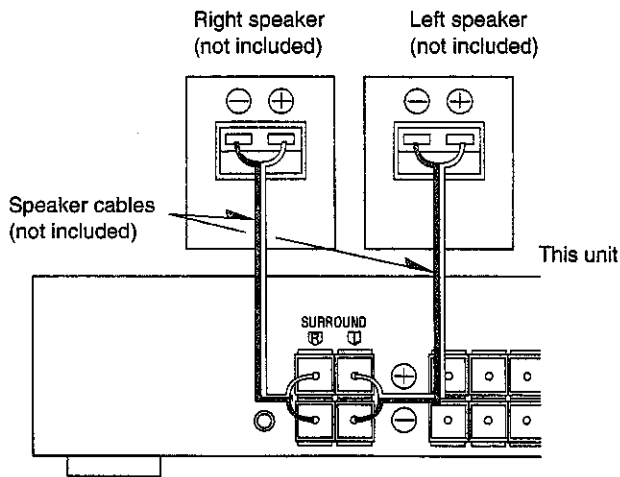

### Note:

1. Before sound can be heard, both surround speakers must be connected.
2. Do not connect the surround speakers to the front speaker terminals. The surround speakers may be damaged if connected to the front terminals due to the output power difference between the front and surround terminals.

## Connection of subwoofer

You can amplify bass sounds by connecting a subwoofer to your receiver.

When connected, the subwoofer can be placed in any position.

### For SA-EX500

This receiver has no amplifier section designed especially for the subwoofer, so you cannot adjust the subwoofer volume level by the receiver.

## To connect a subwoofer which have a built-in amplifier

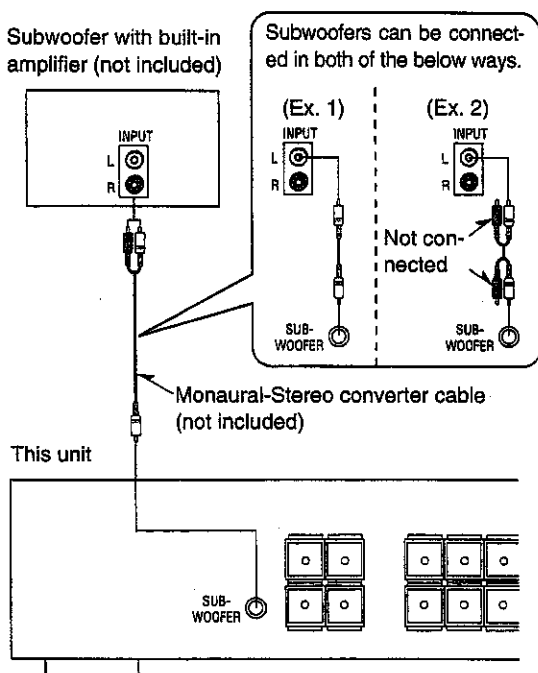

## To connect a subwoofer which does not have a built-in amplifier

Connect an optional amplifier to the "SUBWOOFER" terminals of this unit and then connect a subwoofer to the speaker terminals of the amplifier.

### When adjusting the volume of the subwoofer

After setting the volume control on the subwoofer or on the amplifier which is connected to the subwoofer, make any further adjustments with the volume control on this unit.

## To connect a subwoofer with the speaker cable SA-EX700 only

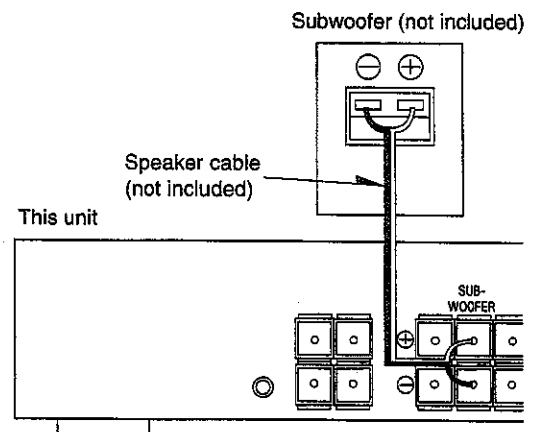

Speaker impedance : 8-16 Ω

# Basic operations

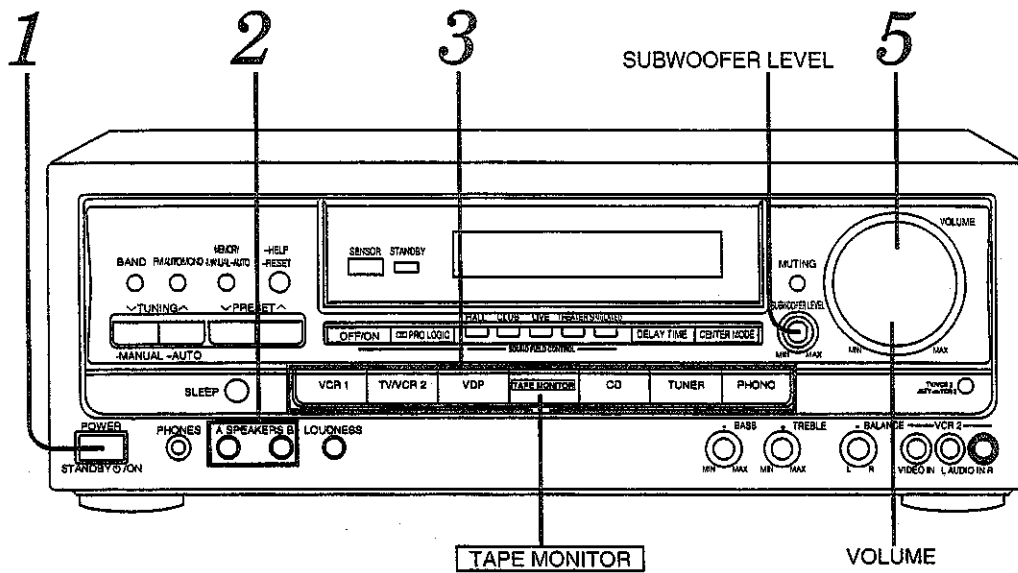



Before operation, set VOLUME to the "MIN" position.

**1**  **Press POWER.**

**3**  **Press to select the desired source.**

**2** **For SA-EX700**

**A SPEAKERS B**  **Press A and/or B to select the speaker system(s) to be used.**  
A and B refer to the speaker terminals at the rear of the unit.



Lights up

- VCR 1:** To watch video tapes (VCR 1)
- TV/VCR 2:** To watch TV or video tapes (VCR 2)
- VDP:** **SA-EX700 only**: To watch laser discs
- TAPE MONITOR:** To listen to cassette tapes (The tape monitor indicator will light up.) (See below.)
- CD:** To listen to compact discs
- TUNER:** To listen to radio broadcasts
- PHONO:** To listen to phono discs

**Note:**  
To watch a video (or laser disc) or the TV, set the TV to either the TV mode or VIDEO mode as indicated below.

- To enjoy videos (or laser disc)  
Set it to VIDEO mode.
- To watch TV  
Set it to TV mode.

**For SA-EX500**

**SPEAKERS**  **Press SPEAKERS and check the "SPEAKERS" indication lights up.**



Lights up

**4** **Start the desired source.**  
(Refer to the appropriate operating instructions for details.)

**5** **Turn VOLUME to adjust the volume level.**  
**For SA-EX700**  
If using a subwoofer, adjust volume with SUBWOOFER LEVEL.

If the button is pressed once more, the indicator will switch off and no sound will be heard from the speakers.

If the button is pressed once more, the indicator will switch off and no sound will be heard from the speakers.

**After listening is finished**  
Be sure to reduce the volume level, and switch the power to the standby condition by pressing POWER.

**When the tape monitor indicator is lit or flashing**  
This indicates that the tape monitor function of this unit is ON.  
To listen to sources other than a tape, be sure to press **TAPE MONITOR** and check the indicator goes out.



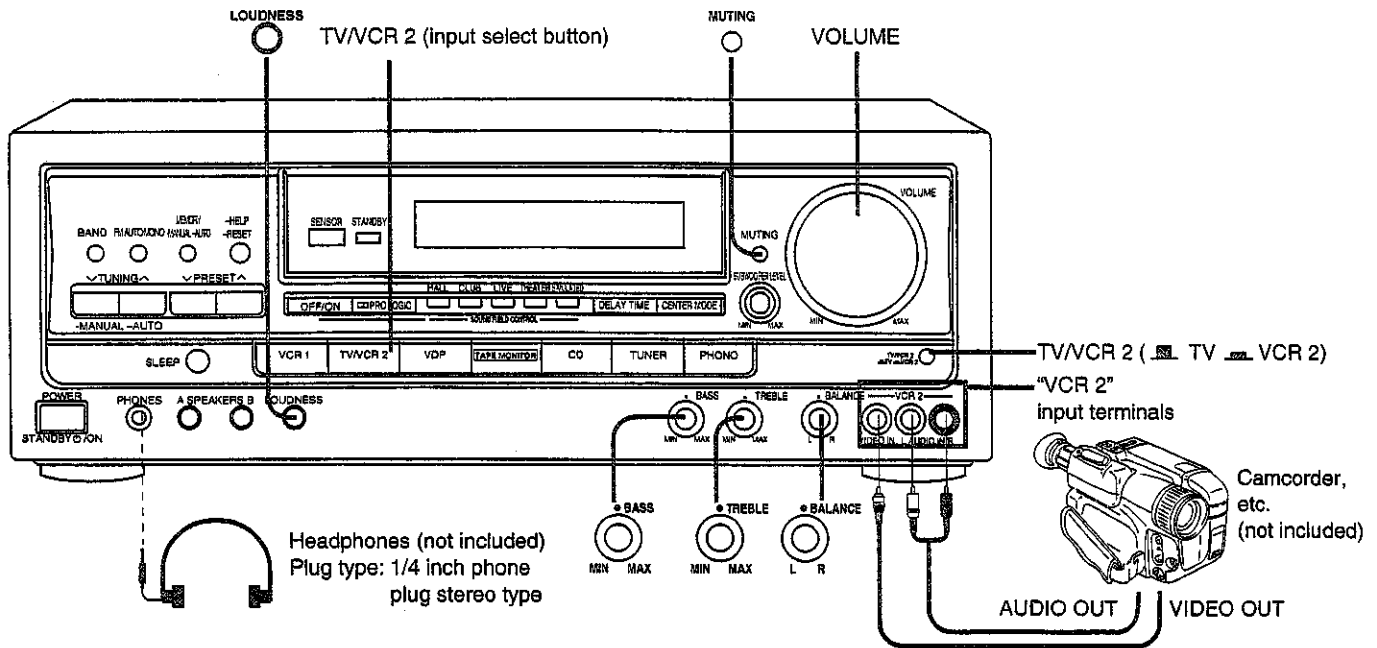

### To adjust the tone quality



Turn **BASS** to adjust the low frequency sound.

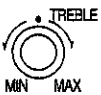

Turn **TREBLE** to adjust the high frequency sound.

### To adjust the sound balance



Turn **BALANCE** to adjust the left/right sound balance.

### To mute the sound level

MUTING



Press **MUTING**.



The message "MUTING ON NOW" runs repeatedly from right to left across the display as long as the muting function is on.

Press once again to return to the previous volume level.

### To emphasize low frequency sound **SA-EX700 only**

LOUDNESS



Press **LOUDNESS**.



Lights up

To return to the previous condition, press once again, then "LOUDNESS" indication turns off.

### Switching between the "TV" terminals (rear side) and "VCR2" terminals (front side) **SA-EX700 only**

The TV/VCR 2 input select button works for both TV input and input from the source connected to the front side "VCR2" terminals (see above illustration).

Select the source as described here below.

1. Press **TV/VCR2 (input select button)**.
2. Press **TV/VCR2 (TV VCR2)** to set to the desired position.

Either "TV" or "FRT-VCR2" will appear on the display.

### To listen through headphones

Use **VOLUME** to reduce the volume level, and connect the headphones.

If you do not want sound from the speakers, press **SPEAKERS** button(s) and check the speaker indicator(s) goes out.

**For SA-EX700**

With these receiver models, you can silence sound from the subwoofer by turning the **SUBWOOFER LEVEL** knob on the receiver to "MIN".

**For SA-EX500**

If a subwoofer is connected to your system, turn off power to it (or the subwoofer amp you are using) or lower the volume to the minimum level.

**Note:** Avoid listening for prolonged periods of time to prevent hearing damage.

# Listening to radio broadcasts

## Sequential tuning

You can use the tuning buttons to tune-in radio broadcasts.

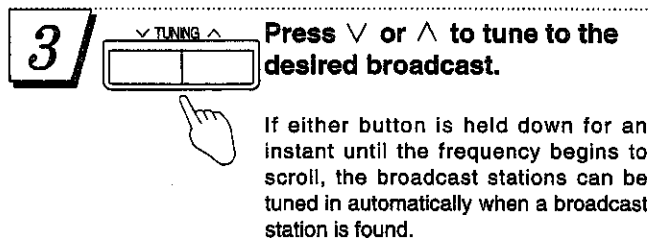
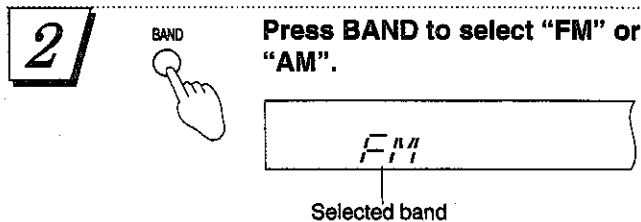
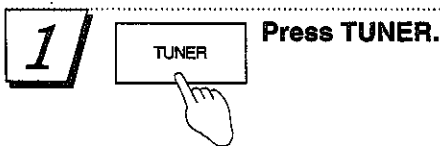
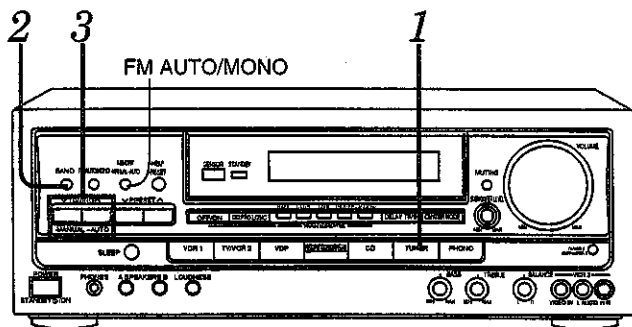

**Note:**

Tuning may stop automatically if any jamming is encountered.

Lights up when tuned

Lights up when an FM stereo broadcast is received

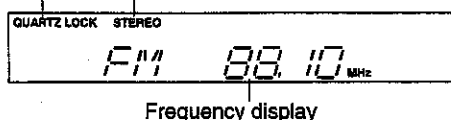

Frequency display

### If noise is excessive in the FM stereo mode

Press FM AUTO/MONO. (The "STEREO" indication will switch off.)

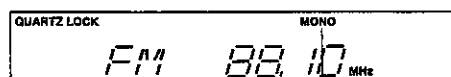

Lights up

The broadcast will be monaural, but noise will be reduced. If the button is pressed once more, the stereo mode will be resumed.

## Preset tuning

Presetting radio stations into the memory channels of this unit makes selecting stations easy and simple.

### Before presetting

#### How many broadcast stations can be preset?

A total of 30 FM and AM stations can be preset.

#### How is presetting done?

The two following methods are available.

##### • Automatic memory presetting

Automatic memory presetting allows this unit to automatically search for broadcast stations and then preset them into memory. With this function, searching proceeds from the frequency currently being displayed and continues to highest frequency, and broadcast stations are preset in the order in which they are located.

With this method, the channels that can be preset into the memory are set as follows for different bands.

Channel

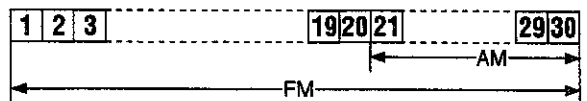

For example, after presetting the FM band, if the AM band is preset, the previous presettings in the sections in the above illustration which overlap will be erased and the subsequent settings will be preset. Therefore, the FM band stations will be kept for channels 1-20 and the AM band stations will be preset to channels 21-30.

##### • Manual memory presetting

The desired broadcast stations can be preset into the desired channels by the user.

This can also be used as a method for changing selected broadcast stations that were preset in "Automatic memory presetting".

**Note:**

If a new broadcast station is preset into a channel, the setting for the broadcast station which was previously entered in that channel will be automatically erased.

## Automatic memory presetting

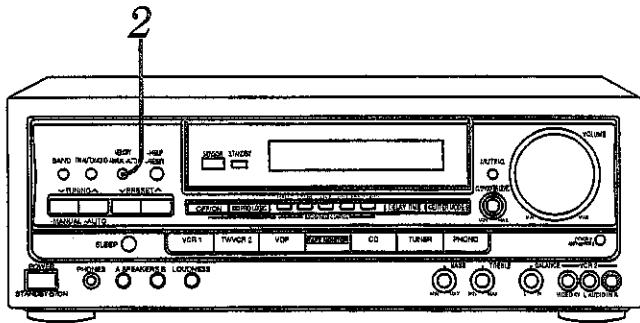

**1** Set to the frequency from which you want to start automatic memory presetting. (See page 14.)

**2** Press **MEMORY** until the frequency begins to change. (Automatic memory presetting will start.)

During automatic memory presetting, the memory indicator will flash while the frequency scrolls.

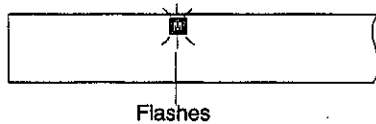

To stop, press **MEMORY** once again.

### When a broadcast station is preset

The memory indicator and the preset channel number will be displayed for approximately 1 second.

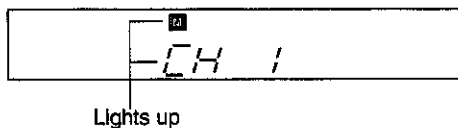

### When presetting is completed

The last broadcast station to be preset will be displayed.

#### Note

Frequencies may not be preset correctly in cases where the broadcast waves are too strong or too weak. In such cases, carry out presetting manually.

## Manual memory presetting

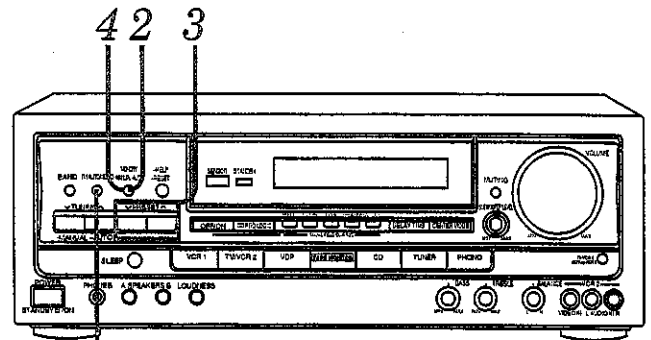

FM AUTOMONO

**1** Set to the desired broadcast. (See page 14.)  
If interference or static is keeping you from enjoying an FM broadcast, press **FM AUTOMONO** and change to monaural. You can preset the memory in monaural just as in stereo.

**2** Press **MEMORY**. (Touch only.)

Lights up

To cancel the memory function, press **MEMORY** again.

**3** Press **∇** or **∧** to select the desired channel.

∇ PRESET ∧

Flashes

Holding the buttons down lets you scroll through channels faster.

**4** Press **MEMORY**.

The channel will blink on the display.

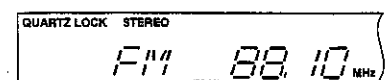

### To continue presetting

Repeat steps 1 through 4.

# Listening to radio broadcasts

## Preset tuning (continued)

### To listen to preset broadcast stations

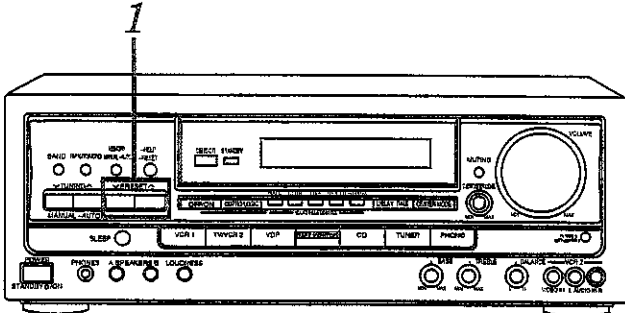

**1** Press  $\nabla$  or  $\wedge$  to select the desired channel.

Preset channel

Holding the buttons down lets you scroll through channels faster.

After the preset channel is displayed, the frequency of the selected channel is displayed.

You can select channels from the remote control with the numeric buttons. See the instruction manual on "How to use the remote control transmitter".

### To confirm the channel number of the broadcast station being received

Press TUNER.  
(The channel number will be displayed for approximately 1 second.)

**Note:**

The channel number is not displayed if you change the reception frequency or FM mode setting.

### For your reference

Even if the power is switched to standby or the power cord is disconnected from the household AC outlet, the memory will retain its contents for approximately one month.

### If frequency presettings are accidentally erased

Make the presettings once again.  
The power cord should remain connected for one hour or more for the memory back-up to be effective.

## Direct access tuning

(Only available from the remote control.)

Specify the frequency using the numeric buttons on the remote control transmitter to directly tune to the desired broadcast station.

**Note:**

First select the band with the BAND button on the receiver.

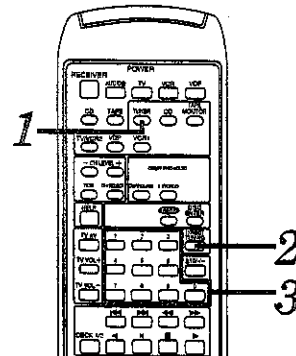

**1** **TUNER** Press TUNER.

This will set the remote control to operate the tuner.

**2** **DIRECT TUNING** Press DIRECT TUNING.

Flashes

While cursor display is flashing (approx. 10 seconds)

**3** Press the appropriate numeric buttons to enter the frequency.

If the desired FM frequency is 107.90 MHz

1 → 0 → 7 → 9 → 0

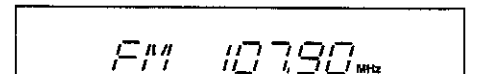

If the frequency has been input correctly, the displayed frequency will blink once.

**Notes**

1. If no button is pressed while the cursor display is flashing, the display will return to the frequency which is currently being received. To re-specify the frequency, repeat the procedure from step 2.
2. If the frequency has not been input correctly, "ERROR" indication will be displayed. In this case, re-enter the frequency.



# Enjoying sound with DOLBY PRO LOGIC

By combining front, center and surround speakers, you can enjoy the SURROUND mode which conveys a feeling of presence or the 3 STEREO mode which conveys a feeling of orientation.

## SURROUND

By reproducing the feeling of depth and movement of sound, video software or compact discs recorded with Dolby Surround provide the listener with a feeling of presence like that of a movie theater.

To enjoy SURROUND, be sure to connect the surround speakers.

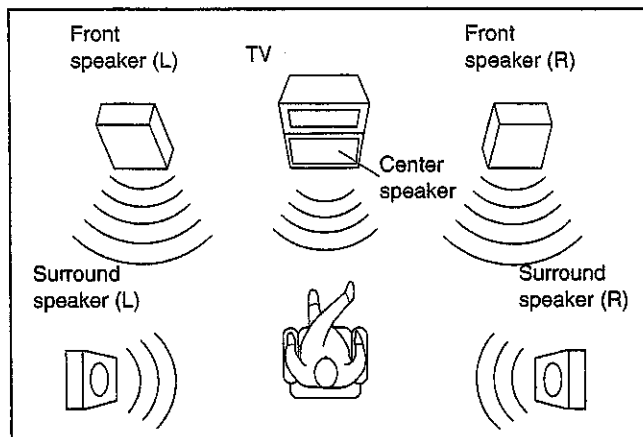

## 3 STEREO

You can enjoy audio/video sources with clear sound, more presence and a good feeling of orientation. 3 STEREO can be used with non DOLBY SURROUND recordings.

To enjoy 3 STEREO, be sure to connect the center speaker.

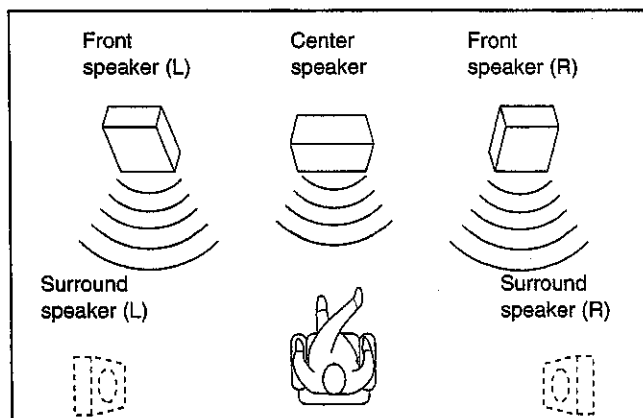

Manufactured under license from Dolby Laboratories Licensing Corporation.

DOLBY, the double-D symbol and "PRO LOGIC" are trademarks of Dolby Laboratories Licensing Corporation.

## Setting the center mode

For Dolby Pro Logic systems, center mode setting is necessary to play back bass sounds effectively. Set the center mode in accordance with the size of your center speaker.

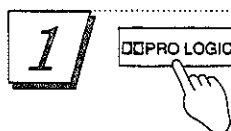
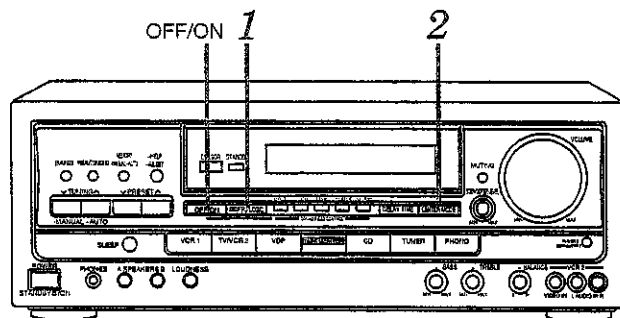

Press PRO LOGIC to turn on the Dolby Pro Logic systems and select the desired mode.

When the button is pressed, the current mode is displayed. Pressing it again changes the Dolby Pro Logic mode.

For SURROUND mode

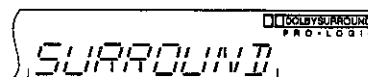

Displayed for approximately 1 second only.

For 3 STEREO mode



Displayed for approximately 1 second only.



Press CENTER MODE to select the correct center mode.

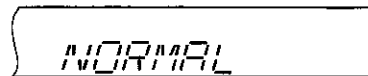

When the button is pressed, the current center mode is displayed. Pressing it again changes the center mode.

### NORMAL

When the center speaker is smaller than the front speakers

### WIDEBAND

When the center speaker is the same or larger size as the front speakers

### PHANTOM

When no center speaker is connected.

**Note:** In the PHANTOM mode, the sound which would have been sent to the center speaker will be divided equally between both the left and right front speakers.

## To turn off the Dolby Pro Logic systems

Press OFF/ON.

Press once again to turn it on.

## Adjusting speaker output level

(Only available from the remote control.)

In order to reproduce the movement of the sound and its clear orientation, it is important to adjust the output level of each speaker. Adjust output to the correct levels while listening to the test signal.

### Note:

- When ready to adjust speaker output level, situate yourself away from the speakers as you normally do when listening.
- First turn ON the speakers with the SPEAKERS button on the receiver.
- If front speakers volume is unbalanced, adjust the balance with the BALANCE knob.

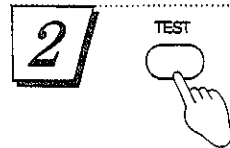
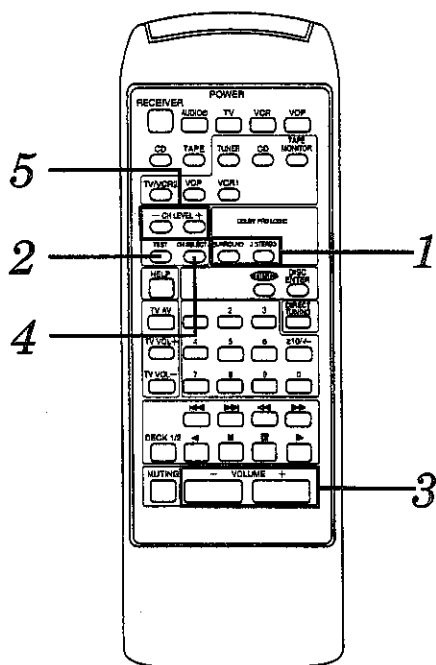

**2** Press TEST to output a test signal.



The speaker outputting the test signal is displayed while the test is running.

L : Front speaker (left)  
C : Center speaker  
R : Front speaker (right)  
S : Surround speakers

**For surround mode**

L → C → R → S

In the PHANTOM mode, the center speaker is OFF, so the test signal is not output and "C" is not displayed.

**For 3 STEREO mode**

L → C → R

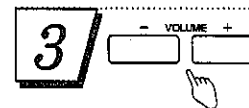

**3** Press VOLUME (-) or (+) to set the volume level normally used for enjoying the source.

The following steps are for setting the output level of the front speakers and the center/surround speakers to the same listening level.

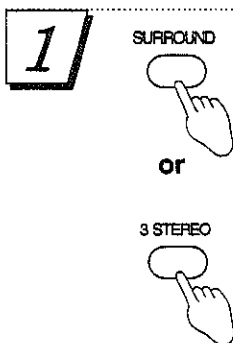

**1** Press SURROUND or 3 STEREO to turn on the desired mode.

For SURROUND mode

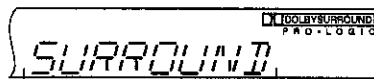

Displayed for approximately 1 second only.

For 3 STEREO mode

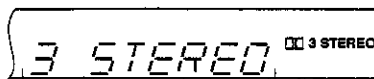

Displayed for approximately 1 second only.

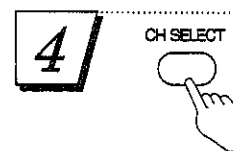

**4** Press CH SELECT to select the speaker you want to adjust.

For the center speaker

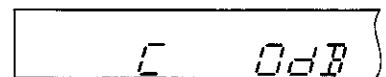

For the surround speakers

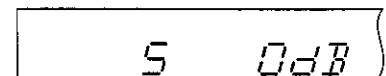

5

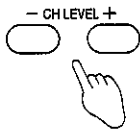

Press CH LEVEL (-) or (+) to adjust the output level.

- : Decrease the output level.
- + : Increase the output level.

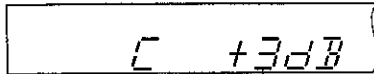

Output level can be varied within a range of -12 dB to +12 dB with front speaker output level serving as the zero point.

6

Repeat steps 4 and 5 until the output level of all speakers is the same.

**Note:**

1. The test signal is output only by the speaker you are now adjusting and does not repeat the sequence until adjustments are complete.
2. Remember you cannot adjust output level of the surround speakers if you selected the 3 STEREO mode in step 1.

**To stop the test signal**



Press TEST.

**To turn off the Dolby Pro Logic systems**



Press the button of the currently selected mode (SURROUND or 3 STEREO).

or



**Adjusting the delay time**

SA-EX700 only

**When enjoying with SURROUND only**

Adjust the sound from the surround speakers until the proper effect is produced.

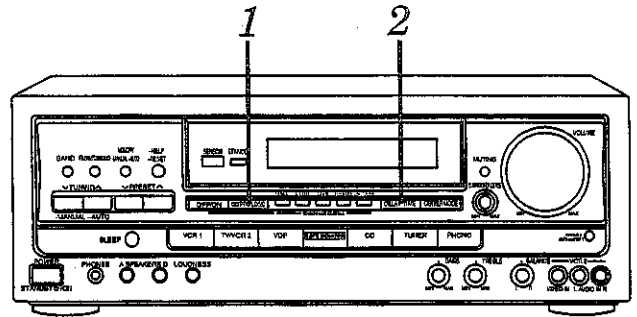

1

PRO LOGIC



Press  PRO LOGIC to turn on the Dolby Pro Logic systems and select the SURROUND mode.

2

DELAY TIME



Press DELAY TIME to set to the suitable time.

When the button is pressed, the current delay time is displayed, pressing it again changes the delay time.

Each time the button is pressed, the delay time will increase by 5 ms.

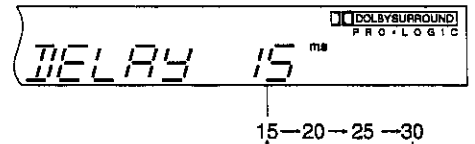

To calculate the delay time, refer to the calculation methods below. The standard setting is 20 ms.

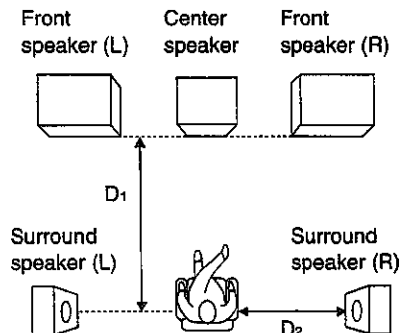

$D_1$ : Distance from front speakers  
 $D_2$ : Distance from surround speakers

- If  $D_1$  is equal to or less than  $D_2$   
Set to 15 ms.
- If  $D_2$  is less than  $D_1$   
Start at 15 ms and increase by 5 ms for every 5 feet of difference between  $D_1$  and  $D_2$ .

## Enjoying sound with DOLBY PRO LOGIC

### Enjoying with SURROUND or 3 STEREO

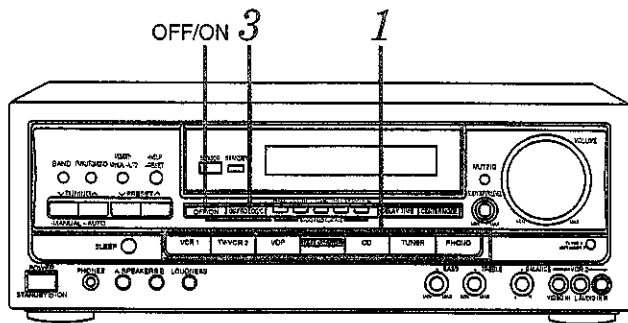

**1** Select the desired source.

A close-up of the source selector buttons: VCR, TV, and PHONO. A hand is shown pointing to the PHONO button.

**2** Start the desired source.

**Note:**  
When employing SURROUND, use software recorded in Dolby Surround.

**3** Press  PRO LOGIC to turn on the Dolby Pro Logic systems and select the desired mode.

A close-up of the PRO LOGIC button. A hand is shown pressing the button.

#### To turn off the Dolby Pro Logic systems

Press OFF/ON.

Press once again to turn it on.

## Enjoying sound with SFC

The SFC function gives presence and spread thereby enhancing and enriching the music or movie.

Read the below explanations in order to better understand how to make your selection.

### HALL

This mode imparts a reflection and spread which will make you feel as if you are in a large concert hall.

### CLUB

Like a jazz club, this mode provides an exciting and intimate atmosphere. It simulates the soundfield of a relatively small room having a low ceiling and hard reflective surfaces, for a "live" sound with enhanced presence to bring the performers up close.

### LIVE

Primarily for vocal pieces, this mode adds gloss to the vocals and you'll feel as though you were hearing a live stage performance.

### THEATER

You can clearly perceive the directions and source of the movie. Real ambience of sound can also be recreated naturally using this mode.

THEATER mode can be used with stereo sources not encoded with DOLBY SURROUND.

**Note:**

When using Dolby surround encoded source materials, select the DOLBY PRO LOGIC SURROUND.

### SIMULATED

Choose this mode if little or no sound will be heard from the surround speakers.

You can feel as if you were in a more expanded space adding to the actual sound from the source.

This mode also adds effect to monaural sources by outputting the sound from surround speakers.

**Note:**

You can adjust center speaker volume only in the THEATER mode. The center speaker is not used in the HALL, and SIMULATED modes.

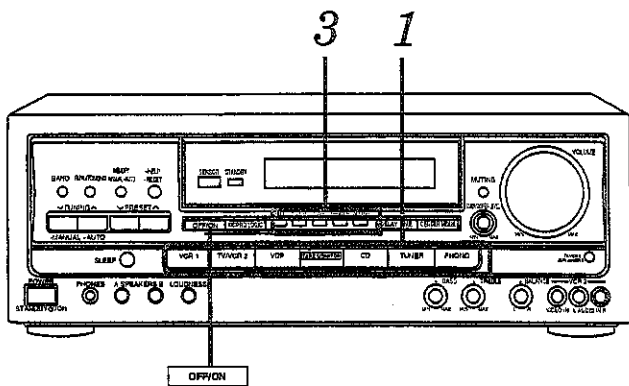

**1** Select the desired source.

**2** Start the desired source.

**3** Select the desired SFC mode.

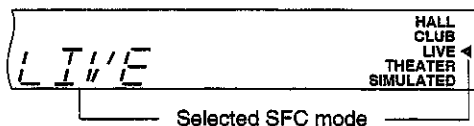

**OFF/ON**  
To turn off the SFC function  
Press OFF/ON.  
Press once again to turn it on.

## Adjusting field of sound

With this unit, you can adjust center and surround speakers volume while listening to a source.

**For SA-EX700**

You can also adjust delay time.

## To adjust center and surround speakers volume

(Only available from the remote control.)

**Note**

Center speaker volume can be adjusted only in the THEATER mode.

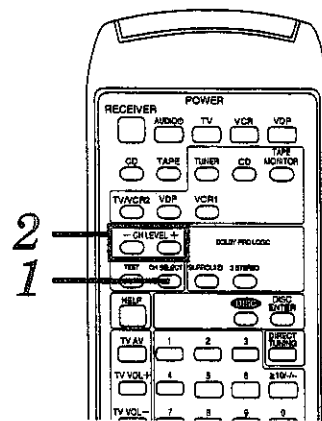

**1** CH SELECT Press CH SELECT to select the center or surround speakers.

**2** -CH LEVEL+ Press CH LEVEL (-) or (+) to adjust the output level.

## To adjust the delay time

**SA-EX700 only**

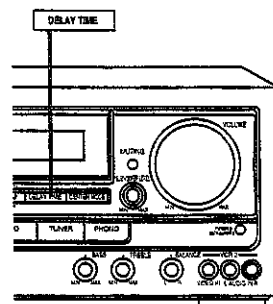

Press DELAY TIME to set the suitable time.

When the button is pressed, the current delay time is displayed, pressing it again changes the delay time.

The delay time increments are different depending on the SFC mode.

# Making a recording

## Recording on the tape deck

Before recording, prepare the tape deck for recording (recording level adjustment, etc.).

See the tape deck's operating instructions for details.

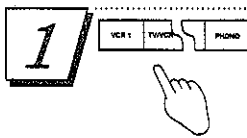
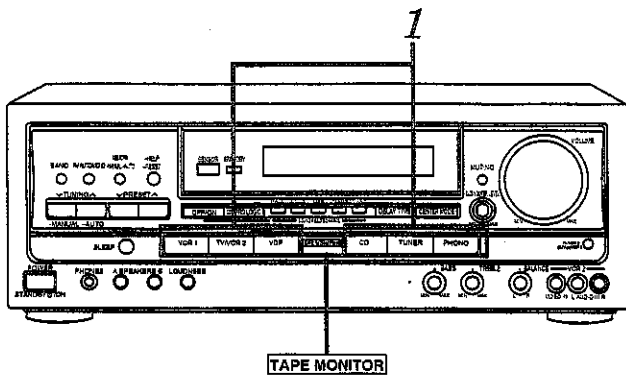

**1** Select the desired source to be recorded.

Press any button except TAPE MONITOR to select the source you want to record from.

**2**

**Begin recording.**  
Follow your tape deck's operating instructions.

**3**

**Begin the desired source to be recorded.**

## Recording on the VCR (VCR 1)

Before recording, prepare the VCR (VCR1) for recording (recording level adjustment, input selector setting, etc.).

See the VCR's operating instructions for details.

## Recording from an audio source

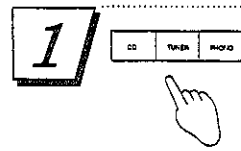
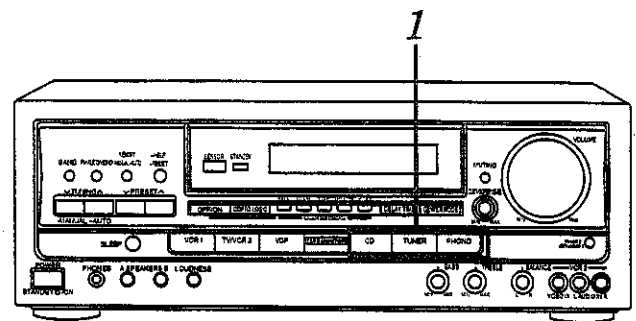

**1** Select the audio source to be recorded.

Press either CD, TUNER or PHONO to select the source you want to record from.

**Note**

Recording from the tape deck is not possible.

**2**

**Begin recording on the VCR 1.**  
Follow your VCR's operating instructions.

**3**

**Begin the audio source to be recorded.**

## To check the sound recorded while a recording is being made

With a tape deck with 3 head system, it is possible to check the sound recorded on the tape.

Press **TAPE MONITOR** on this unit and set the monitor button on the tape deck to "TAPE".



Press **TAPE MONITOR** once again to turn it off.

## Recording on the VCR (VCR 1) (continued)

### Recording from the TV

**For SA-EX500**

If a TV is connected to the "TV/VCR 2" terminals, you can record off it.

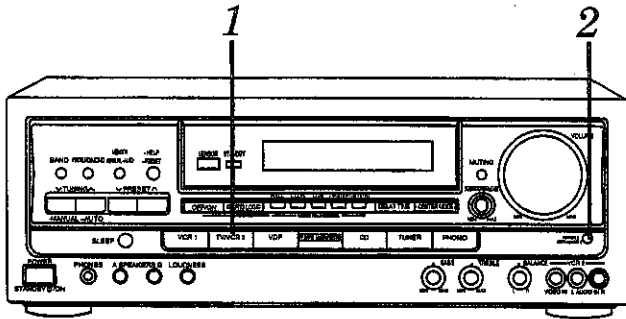

**Note:**

Be sure to set the TV/VIDEO mode on the TV to "TV".

**1** Press TV/VCR 2 (input select button).

**2** SA-EX700 only  
Set TV/VCR 2 (TV - VCR 2) to "TV" position.

**3** Select the TV channel.

**4** Begin recording on the VCR 1. Follow your VCR's operating instructions.

### Recording from a second VCR (VCR 2) or laser disc player (VDP)

**For SA-EX700**

You can record from a camcorder or other video sources by connecting the source to the "VCR2" terminals on the front and "VDP" terminals on the rear of the receiver.

**For SA-EX500**

If a second VCR or laser disc player is connected to the "TV/VCR 2" terminals, you can record off it.

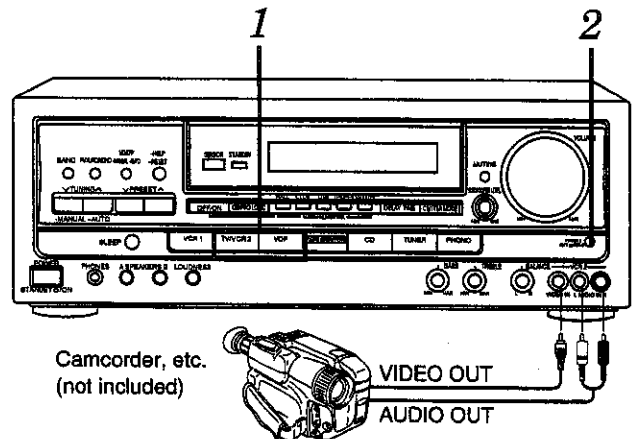

To watch the picture you are recording into VCR 1, set the TV to the VIDEO mode.

**1** For SA-EX700  
Press TV/VCR 2 (input select button) or VDP.

**For SA-EX500**  
Press TV/VCR 2 (input select button).

**2** SA-EX700 only  
(Only if you pressed TV/VCR2 in the above step)  
Set TV/VCR 2 (TV - VCR 2) to "VCR 2" position.

**3** Begin recording on the VCR 1. Follow your VCR's operating instructions.

**4** Begin playback the tape on the second VCR or laser disc player.

## Sleep timer function

The sleep timer is an excellent little feature that lets you fall asleep with the radio. You can set the timer to turn off after 30, 60 or 90 minutes.

### Note

The sleep timer turns off the receiver, but it does not turn off any externally connected components.

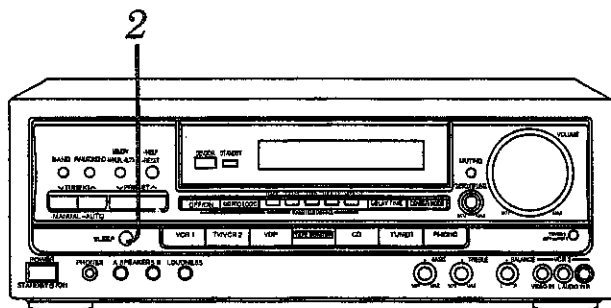

1

**Set to the desired broadcast.**  
(See pages 14-16.)

2

SLEEP



(While listening a source)  
**Press SLEEP and set how long (minutes) you want the source to continue playing.**

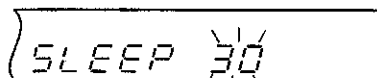

30 → 60 → 90 → OFF

The display returns to the way it was before in about 5 seconds, and the "SLEEP" indicator will appear on the display.

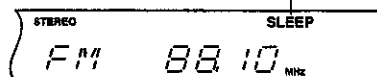

### To cancel the sleep timer

Press SLEEP until "OFF" is displayed. The "SLEEP" indicator will go out.

### To check how much time is left (while the timer is running)

Press SLEEP once.

### Note

Do not press SLEEP again before the remaining time indication goes out. If you do so, the timer will return to the setting mode.

### To change the setting time (while the timer is running)

1. Press SLEEP.
2. Press SLEEP again while the remaining time is displayed and then reset the timer (30, 60 or 90 minutes).

## About the HELP function

If you make a mistake in operation or if sound output stops due to some operation which was performed, the HELP function displays information which can be useful for indicating the method by which this condition can be remedied.

If "ERROR" or scrolling characters (for instance, "TAPE MONITOR ON NOW") appears on the display during operation, carry out the following operation.

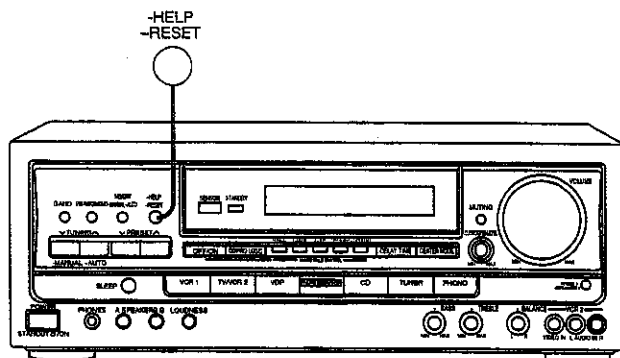

-HELP  
-RESET



### Press -HELP.

(Touch only.)

The method for remedying this situation will be displayed.

### For your reference

If the above button is pressed for 2 second or more until "RESET" appears on the display, the operation settings for the unit will be initialized to the settings made at the time of shipment. However, any broadcasting stations which have been preset into memory will not be erased at this time.

### When the -HELP button is flashing

When you press the -HELP button, it will stop flashing and the message "HIGH TEMP-REDUCE VOLUME" will scroll across the display. This is to notify you that the receiver is hot for some reason, perhaps because volume is too high or the ambient you're using the receiver in is too hot. In this situation, you have to cool down the receiver so try turning down the volume or turning the unit OFF. If that doesn't work, try cooling down the ambient.

The message will reappear every time you press the -HELP button until receiver temperature is sufficiently lowered.



# Troubleshooting guide

Before requesting service for this unit, check the chart below for a possible cause of the problem you are experiencing. Some simple checks or a minor adjustment on your part may eliminate the problem and restore proper operation.

If you are in doubt about some of the check points, or if the remedies indicated in the chart do not solve the problem, refer to

the directory of Authorized Service Centers (enclosed with this unit) to locate a convenient service center, or consult your Technics dealer for instructions.

Problem	Probable cause(s)	Suggested remedy
<b>While listening to FM broadcasts</b>		
An unusual hissing noise is heard when listening to the broadcast in stereo, but not heard when listening monaurally.	A slight noise may be heard because the method used for modulation of FM stereo broadcasts is different than that used for monaural broadcasts.	<ul style="list-style-type: none"> <li>• Try reducing the treble sound by using the treble control.</li> <li>• Try changing the location, height and/or direction of the antenna.</li> <li>• If an indoor antenna is being used, change to an outdoor antenna.</li> <li>• Try using an antenna with more elements.</li> </ul>
Noise is excessive in both stereo and monaural broadcasts.	Poor location and/or direction of the antenna. Transmitting station is too far away.	<ul style="list-style-type: none"> <li>• Try using an antenna with more elements.</li> </ul>
The FM stereo indicator or the quartz lock indicator flickers, without completely illuminating.	Poor location and/or direction of the antenna. Transmitting station is too far away.	<ul style="list-style-type: none"> <li>• Try changing the location, height and/or direction of the antenna.</li> <li>• If an indoor antenna is being used, change to an outdoor antenna.</li> <li>• Try using an antenna with more elements.</li> </ul>
Excessive distortion in the sound of stereo broadcasts.	Nearby building or mountain.	<ul style="list-style-type: none"> <li>• Try using an antenna with more elements.</li> </ul>

<b>While listening to AM broadcasts</b>		
An unusual "beat" sound is heard.	Unit is being used at the same time as the television set. Interference from adjacent broadcast signal.	<ul style="list-style-type: none"> <li>• Turn off the television set, or use this unit farther away from it.</li> <li>• Try reducing the treble sound by using the treble control.</li> </ul>
A low-pitched "hum" sound is heard when the broadcast is tuned.	The AM loop antenna connection wires are too close to the power cord. The power supply frequency from the power cord is modulated and heard from the speakers.	<ul style="list-style-type: none"> <li>• Place the antenna connection wires and the power cord farther apart.</li> <li>• Install a special outdoor antenna.</li> </ul>
A strange hissing noise is produced continuously or intermittently.	Caused by the "discharge phenomenon" and the "oscillation phenomenon" of electric appliances (such as fluorescent lights, TV, small series-type motors, rectification equipment, etc.).	<ul style="list-style-type: none"> <li>• Try placing this unit farther away from such equipment.</li> </ul>

<b>Problems noted at all times</b>		
Power will not switch ON.	The power cord plug is not completely inserted.	<ul style="list-style-type: none"> <li>• Confirm that the power cord plug is connected completely.</li> </ul>
No sound is heard.	The speaker button(s) is(are) turned off.	<ul style="list-style-type: none"> <li>• Press the HELP button. (The display will scroll through the guide to remedy the problem.)</li> </ul>
	The tape monitor function is ON.	
	The muting function is ON.	
	Connections are incomplete or incorrect to the speaker systems, etc.	<ul style="list-style-type: none"> <li>• Check to be sure that all connection wires are correctly connected.</li> </ul>
	The incorrect input selector has been pressed.	<ul style="list-style-type: none"> <li>• Check to be sure that the correct selector is pressed.</li> </ul>
Sound stops during a performance, or no sound is heard when the power is switched ON. (The word "OVERLOAD" appears on the display.)	The protection circuitry has functioned because the positive and negative speaker connection wires are "shorted", speaker systems with an impedance less than the indicated rated impedance of this unit are used or under severe use, such as loud volume, excessive power and in an excessively hot environment.	<ul style="list-style-type: none"> <li>• Switch off the power, and after determining and correcting the cause, switch on the power once again.</li> <li>• Use a speaker system of the proper impedance rating.</li> </ul>
The word "ERROR" appears on the display. <small>SA-EX700 only</small>	When the Dolby Pro Logic system is ON, both A and B speakers are turned ON.	<ul style="list-style-type: none"> <li>• Press the HELP button. (The display will scroll through the guide to remedy the problem.)</li> </ul>
	When both A and B speakers are being used simultaneously, the Dolby Pro Logic system is turned ON.	

# Technical specifications (DIN 45 500)

## ■ AMPLIFIER SECTION

Power output (at 240 V)  
 DIN 1 kHz (T.H.D. 1%) 2X100 W (8 Ω)  
 20 Hz–20 kHz continuous power output both channels driven  
 2X90 W (8 Ω)

Total harmonic distortion  
 rated power at 20 Hz–20 kHz 0.05% (8 Ω)  
 half power at 1 kHz 0.03% (8 Ω)

Power output at the Dolby Pro Logic operation  
 DIN 1 kHz (T.H.D. 1%)  
 Front 2X60 W (8 Ω)  
 Center 60 W (8 Ω)  
 Surround 60 W (8 Ω)  
 Subwoofer [SA-EX700 only] 60 W (8 Ω)

Load impedance  
 Front  
 [SA-EX700]  
 A or B 8–16 Ω  
 A and B 8–16 Ω  
 [SA-EX500]  
 Center 8–16 Ω  
 Surround 4–16 Ω  
 Subwoofer [SA-EX700 only] 8–16 Ω

Intermodulation distortion  
 rated power at 60 Hz: 7 kHz=4:1, SMPTE 0.5% (8 Ω)

Power bandwidth  
 both channels driven, –3 dB 10 Hz–40 kHz (8 Ω)  
 Damping factor 30 (8 Ω)

Frequency response  
 PHONO RIAA standard curve  
 (30 Hz–15 kHz) ±0.8 dB

[SA-EX700] CD, TAPE, VDP, TV, VCR 1, VCR 2  
 10 Hz–40 kHz, ±3 dB  
 [SA-EX500] CD, TAPE, VCR 1, TV/VCR 2  
 10 Hz–40 kHz, ±3 dB

Input sensitivity and impedance  
 PHONO 3 mV/47 kΩ  
 [SA-EX700] CD, TAPE, VDP, TV, VCR 1, VCR 2 200 mV/22 kΩ  
 [SA-EX500] CD, TAPE, VCR 1, TV/VCR 2 200 mV/22 kΩ

S/N at rated power (8 Ω)  
 PHONO 70 dB (IHF, A: 80 dB)  
 [SA-EX700] CD, TAPE, VDP, TV, VCR 1, VCR 2  
 75 dB (IHF, A: 85 dB)  
 [SA-EX500] CD, TAPE, VCR 1, TV/VCR 2 75 dB (IHF, A: 85 dB)

Tone controls  
 BASS 50 Hz, +10 to –10 dB  
 TREBLE 20 kHz, +10 to –10 dB  
 Loudness control (volume at –30 dB) [SA-EX700 only]  
 50 Hz, +9 dB

Output voltage  
 VCR 1 OUT, TAPE REC (OUT) 200 mV  
 Channel balance (250 Hz–6.3 kHz) ±1 dB  
 Channel separation 55 dB  
 Headphones output level and impedance 430 mV/330 Ω  
 Subwoofer frequency response [SA-EX700 only] 7–100 Hz

## ■ FM TUNER SECTION

Frequency range 87.50–108.00 MHz  
 Sensitivity  
 S/N 30 dB 1.5 μV/75 Ω  
 S/N 26 dB 1.3 μV/75 Ω  
 S/N 20 dB 1.2 μV/75 Ω  
 IHF usable sensitivity 1.5 μV/75 Ω (IHF '58)  
 IHF 46 dB stereo quieting sensitivity 22 μV/75 Ω

Total harmonic distortion  
 MONO 0.2%  
 STEREO 0.3%

S/N  
 MONO 60 dB (75 dB, IHF)  
 STEREO 58 dB (71 dB, IHF)

Frequency response 20 Hz–15 kHz, +1 dB, –2 dB

Alternate channel selectivity  
 ±400 kHz 65 dB

Capture ratio 1 dB

Image rejection at 98 MHz 40 dB

IF rejection at 98 MHz 70 dB

Spurious response rejection at 98 MHz 70 dB

AM suppression 50 dB

Stereo separation  
 1 kHz 40 dB

Carrier leak  
 19 kHz –30 dB (–35 dB, IHF)

38 kHz –50 dB (–55 dB, IHF)

Channel balance (250 Hz–6.3 kHz) ±1.5 dB

Limiting point 1.2 μV

Bandwidth  
 IF amplifier 180 kHz

FM demodulator 1000 kHz

Antenna terminal(s) 75 Ω (unbalanced)

## ■ AM TUNER SECTION

Frequency range  
 AM 522–1611 kHz (9 kHz steps)  
 530–1620 kHz (10 kHz steps)

Sensitivity  
 AM 20 μV, 330 μV/m

Selectivity  
 AM (at 999 kHz) 55 dB

Image rejection  
 AM (at 999 kHz) 40 dB

IF rejection  
 AM (at 999 kHz) 55 dB

## ■ VIDEO SECTION

Output voltage at 1 V input (unbalanced) 1 ±0.1 Vp-p  
 Maximum input voltage 1.5 Vp-p  
 Input/output impedance 75 Ω (unbalanced)

## ■ GENERAL

Power supply AC 50 Hz, 230–240 V  
 Power consumption [SA-EX700] 220 W  
 [SA-EX500] 205 W

Dimensions (W×H×D) [SA-EX700] 430×158×358 mm  
 [SA-EX500] 430×136×358 mm

Weight [SA-EX700] 10.3 kg  
 [SA-EX500] 9.3 kg

### Notes:

- Specifications are subject to change without notice. Weight and dimensions are approximate.
- Total harmonic distortion is measured by the digital spectrum analyzer.

# Memo

---

**Matsushita Electric Industrial Co., Ltd.**  
Central P.O. Box 288, Osaka 530-91, Japan

**To turn the receiver ON/OFF**

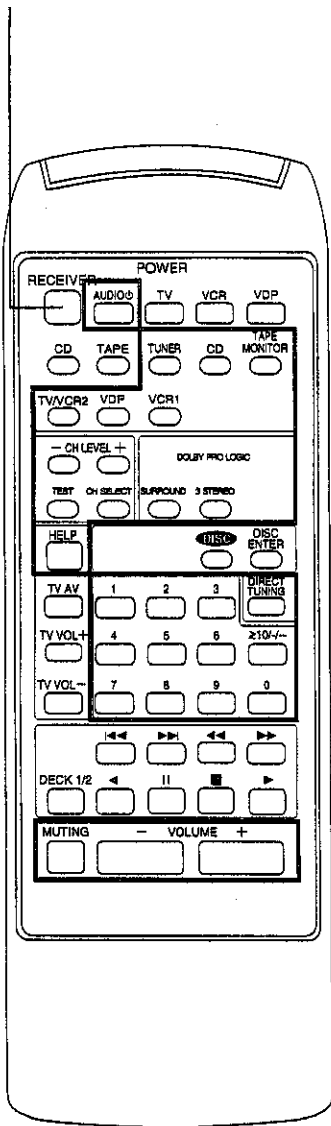

**To operate the receiver**

**To select an input source**

**SA-EX700**



**SA-EX500/EX300**

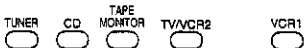

**To mute the sound level**

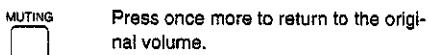

**To adjust the volume level**

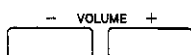

**To display simple receiver information and procedures for remedying trouble**



**To turn the audio system OFF**

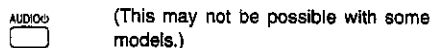

**To listen to radio broadcasts**

**To switch the remote control transmitter to tuner operation mode**



Be sure to press this button before operating the receiver.

**To select the desired channel (Preset tuning)**

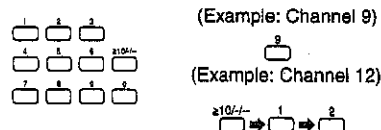

**To select radio stations by frequency (Direct tuning)**

First select the band with the BAND button on the receiver.

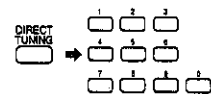

(Example: 107.90 MHz)

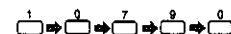

**To use Dolby Pro Logic**

**To turn the SURROUND mode ON/OFF**



**To turn the 3 STEREO mode ON/OFF**



**To output a test signal**

When the 3 STEREO or SURROUND mode is ON

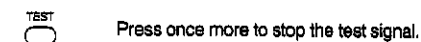

**To adjust the output level of center speaker and/or surround speakers**

When the 3 STEREO or SURROUND mode is ON

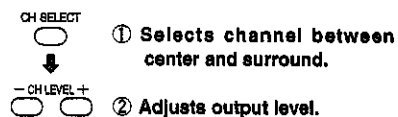

# Technics®

## How to use the remote control transmitter RAK-SA612WH

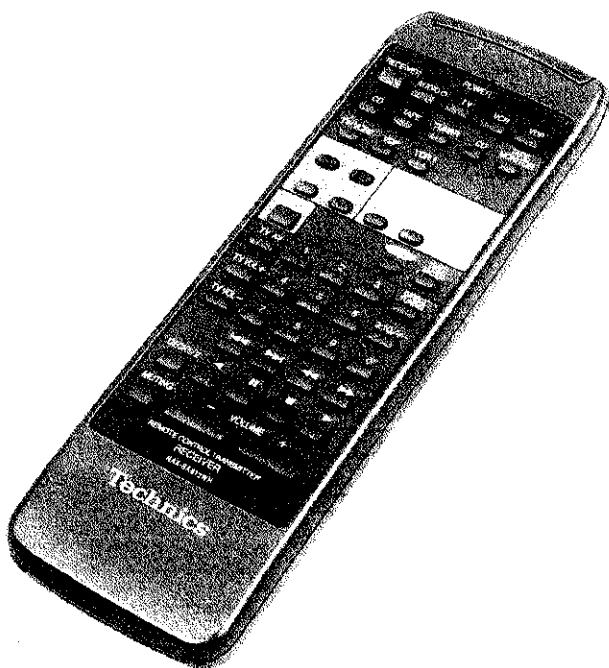

This remote control transmitter can be used to operate other units manufactured by this company in addition to this receiver, including TVs and VCRs manufactured since 1985, laser disc players, CD players (or CD changers) and cassette decks which are equipped with a remote control sensor.

For detailed information concerning operation steps, etc., please refer to the appropriate page for each unit and the respective operating instructions.

## Before use

### Battery installation

Insert the batteries included with this unit as shown below.

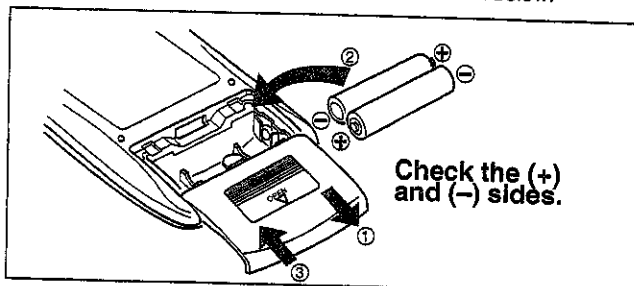

### Use of batteries

- Do not mix old and new batteries, or batteries of different types (carbon, alkaline, etc.).
- Never subject batteries to excessive heat or flame; do not attempt to disassemble them; and be sure they are not short-circuited.
- If the remote control is not to be used for a long period of time, remove the batteries and store them in a cool, dark place.
- Do not attempt to recharge alkaline or carbon batteries.
- Do not use rechargeable type batteries.

### Battery life

Battery life is about one year.

The batteries should be replaced if the receiver fails to respond to commands from the remote control transmitter even when held close to the remote control signal sensor.

### When you need to replace these batteries

Use two UM-4, "AAA", IEC R03 (1.5 V) or equivalent batteries.

### Correct method of use

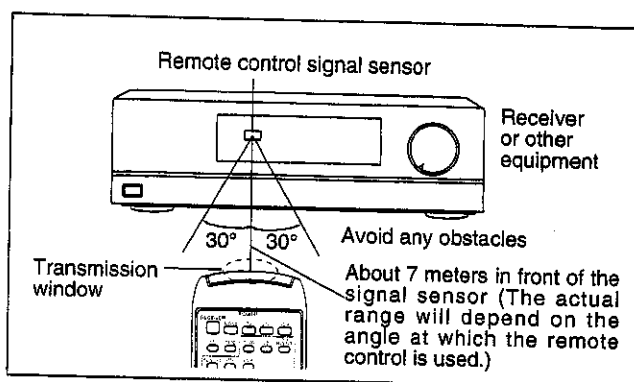

### Operation notes

- Aim the remote control's transmission window toward the unit's sensor. Avoid any obstacles.
- Be sure the transmission window and the unit's sensor are free from dust. Excessive dust might affect performance.
- Do not expose the remote control signal sensor to direct sunlight or to the bright light of an inverter fluorescent light.

To turn the laser disc player ON/OFF

(E)

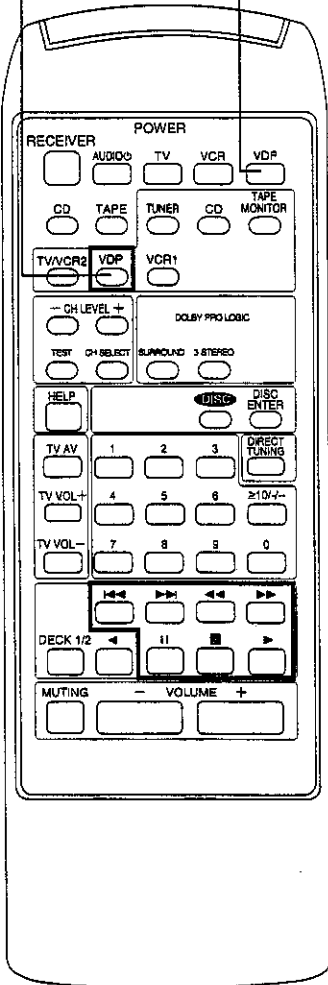

## To operate laser disc players

To switch the remote control to laser disc player operation mode

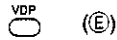

Be sure to press this button before operating the laser disc player.

To start play



To search for the desired position

In the play mode

(Backward) (Forward)

To skip a chapter

In the play or pause mode

(Backward) (Forward)

To stop play temporarily



Press to resume play.

To stop play



To turn the CD player (or CD changer) ON/OFF

(A)

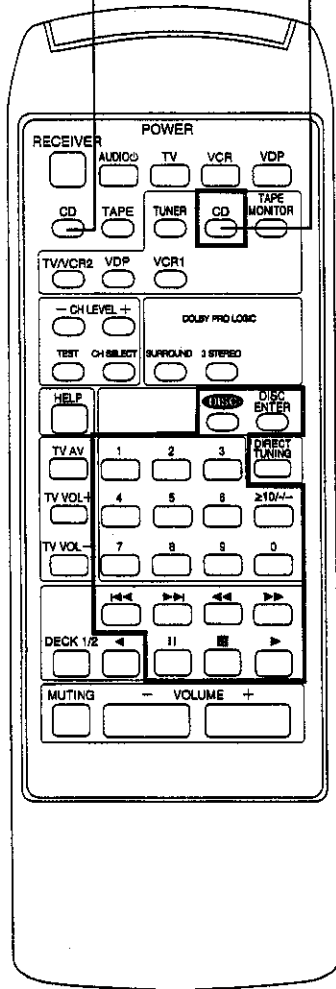

## To operate a CD player (or CD changer)

To switch the remote control to CD player (or CD changer) operation mode



Be sure to press this button before operating the CD player (or CD changer).

To start play



[CD changer only]

To start play from the desired disc  
(For 5 CD changer)

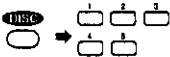

(For MEGA CD changer ※)

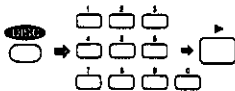

If you select "0", the changer will switch to the single disc play mode.  
(When selecting discs, the ≥10/-- button does not respond to touch.)



For your reference

If you press this button instead of the ► button shown in the above procedure, the CD changer will stop and display the disc number.  
To start the disc, press ►.

To start play from the desired track

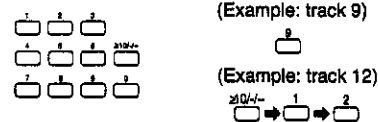

To search for the desired position

In the play or pause mode

(Backward) ◀▶ (Forward)

To skip a track

(Backward) ◀▶ (Forward)

To stop play temporarily



To stop play



To turn the cassette deck ON/OFF

(B)

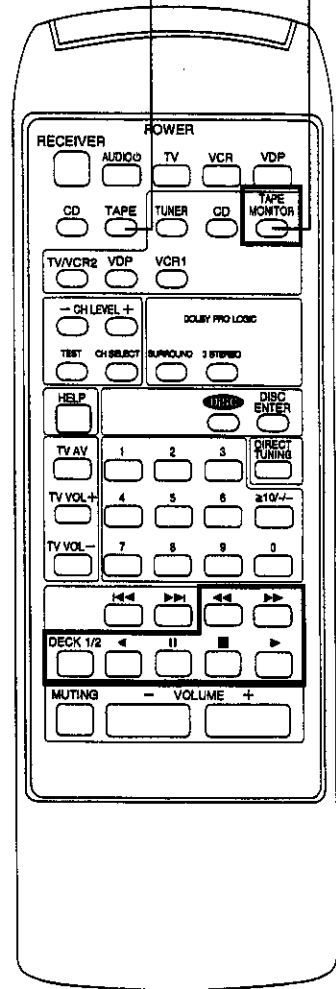

※ By "MEGA CD changer", it is meant any Technics CD changer that takes more than 50 discs.





## Free Manuals Download Website

<http://myh66.com>

<http://usermanuals.us>

<http://www.somanuals.com>

<http://www.4manuals.cc>

<http://www.manual-lib.com>

<http://www.404manual.com>

<http://www.luxmanual.com>

<http://aubethermostatmanual.com>

Golf course search by state

<http://golfingnear.com>

Email search by domain

<http://emailbydomain.com>

Auto manuals search

<http://auto.somanuals.com>

TV manuals search

<http://tv.somanuals.com>