

Digital Surround Processor
SH-AC500D

Technics®

Operating Instructions



Before operating this unit, please read these instructions completely.
Please save this manual.

RQT4536-P

Dear Customer

Thank you for purchasing this product.
For optimum performance and safety, please read these operating instructions carefully.

Table of contents

Before use	
Precautions	3
Accessories	4
Concerning the remote control	4
Front panel controls	5
Connections	6
Speaker installation	9
Using this unit	9
Operation	
Speaker setting	10
Speaker output adjustments	11
Delay time adjustments	13
Reproduction modes	14
Enjoying sound in a variety of reproduction modes	15
Other functions	17
Setting the midnight mode (dynamic range compression)	17
Muting the sound temporarily	17
Selecting the display panel brightness	17
Reference	
Remote control quick reference	18
Troubleshooting guide	19
Product service	Back cover
Technical specifications	Back cover

User memo:

DATE OF PURCHASE
DEALER NAME
DEALER ADDRESS
TELEPHONE NUMBER

The model number and serial number of this product can be found on either the back or the bottom of the unit. Please note them in the space provided below and keep for future reference.

MODEL NUMBER	SH-AC500D
SERIAL NUMBER	

WARNING:
TO REDUCE THE RISK OF FIRE, ELECTRIC SHOCK OR PRODUCT DAMAGE, DO NOT EXPOSE THIS APPLIANCE TO RAIN, SPLASHING, DRIPPING OR MOISTURE.

CAUTION:
TO PREVENT ELECTRIC SHOCK MATCH WIDE BLADE OF PLUG TO WIDE SLOT, FULLY INSERT.

	<p>CAUTION RISK OF ELECTRIC SHOCK DO NOT OPEN</p>	
<p>CAUTION: TO REDUCE THE RISK OF ELECTRIC SHOCK, DO NOT REMOVE SCREWS. NO USER-SERVICEABLE PARTS INSIDE. REFER SERVICING TO QUALIFIED SERVICE PERSONNEL.</p>		

 The lightning flash with arrowhead symbol, within an equilateral triangle, is intended to alert the user to the presence of uninsulated "dangerous voltage" within the product's enclosure that may be of sufficient magnitude to constitute a risk of electric shock to persons.

 The exclamation point within an equilateral triangle is intended to alert the user to the presence of important operating and maintenance (servicing) instructions in the literature accompanying the appliance.

Precautions

Before using this unit please read these operating instructions carefully. Take special care to follow the warnings indicated on the unit itself as well as the safety suggestions listed below.

Afterwards keep them handy for future reference.

Safety

1. **Power Source** -- The unit should be connected to power supply only of the type described in the operating instructions or as marked on the unit.
2. **Polarization** -- If the unit is equipped with a polarized AC power plug (a plug having one blade wider than the other), that plug will fit into the AC outlet only one way. This is a safety feature. If you are unable to insert the plug fully into the outlet, try reversing the plug. If the plug should still fail to fit, contact your electrician to replace your obsolete outlet. Do not defeat the safety purpose of the polarized plug.
3. **Power Cord Protection** -- AC power supply cords should be routed so that they are not likely to be walked on or pinched by items placed upon or against them. Never take hold of the plug or cord if your hand is wet, and always grasp the plug body when connecting or disconnecting it.
4. **Nonuse Periods** -- When the unit is not used, turn the power off. When left unused for a long period of time, the unit should be unplugged from the household AC outlet.

Installation

Environment

1. **Water and Moisture** -- Do not use this unit near water-for example, near a bathtub, washbowl, swimming pool, or the like. Damp basements should also be avoided.
2. **Heat** -- The unit should be situated away from heat sources such as radiators and the like. It also should not be placed in temperatures less than 5°C (41°F) or greater than 35°C (95°F).

Placement

1. **Ventilation** -- The unit should be situated so that its location or position does not interfere with its proper ventilation. Allow 10 cm (4") clearance from the rear of the unit.
2. **Foreign Material** -- Care should be taken so that objects do not fall into and liquids are not spilled into the unit. Do not subject this unit to excessive smoke, dust, mechanical vibration, or shock.
3. **Magnetism** -- The unit should be situated away from equipment or devices that generate strong magnetic fields.
4. **Stacking** -- Do not place heavy objects, other than system components, on top of the unit.
5. **Surface** -- Place the unit on a flat, level surface.
6. **Carts and Stands** -- The unit should be used only with a cart or stand that is recommended by the manufacturer. The unit and cart combination should be moved with care. Quick stops, excessive force, and uneven surfaces may cause the unit and cart combination to overturn.

7. **Wall or Ceiling Mounting** -- The unit should not be mounted to a wall or ceiling, unless specified in this operating instructions.

Maintenance

Clean the cabinet, panel and controls with a soft cloth lightly moistened with mild detergent solution.

Do not use any type of abrasive pad, scouring powder or solvent such as alcohol or benzene.

Service

1. **Damage Requiring Service** -- The unit should be serviced by qualified service personnel when:
 - (a) The AC power supply cord or the plug has been damaged; or
 - (b) Objects have fallen or liquid has been spilled into the unit; or
 - (c) The unit has been exposed to rain; or
 - (d) The unit does not appear to operate normally or exhibits a marked change in performance; or
 - (e) The unit has been dropped, or the enclosure damaged.
2. **Servicing** -- The user should not attempt to service the unit beyond that described in the operating instructions. All other servicing should be referred to an authorized service personnel. For the address of an authorized servicenter:
In the U.S.A. 1-800-211-7262
or web site (<http://www.panasonic.com>)
In Canada 905-624-5505
or web site (www.panasonic.ca/fdbckca.htm)

THE FOLLOWING APPLIES ONLY IN THE U.S.A.

CAUTION:

This equipment has been tested and found to comply with the limits for a Class B digital device, pursuant to Part 15 of the FCC Rules. These limits are designed to provide reasonable protection against harmful interference in a residential installation. This equipment generates, uses and can radiate radio frequency energy and, if not installed and used in accordance with the instructions, may cause harmful interference to radio communications. However, there is no guarantee that interference will not occur in a particular installation. If this equipment does cause harmful interference to radio or television reception, which can be determined by turning the equipment off and on, the user is encouraged to try to correct the interference by one of the following measures:

- Reorient or relocate the receiving antenna.
- Increase the separation between the equipment and receiver.
- Connect the equipment into an outlet on a circuit different from that to which the receiver is connected.
- Consult the dealer or an experienced radio/TV technician for help.

Any unauthorized changes or modifications to this equipment would void the user's authority to operate this device.

This device complies with Part 15 of the FCC Rules. Operation is subject to the following two conditions: (1) This device may not cause harmful interference, and (2) this device must accept any interference received, including interference that may cause undesired operation.

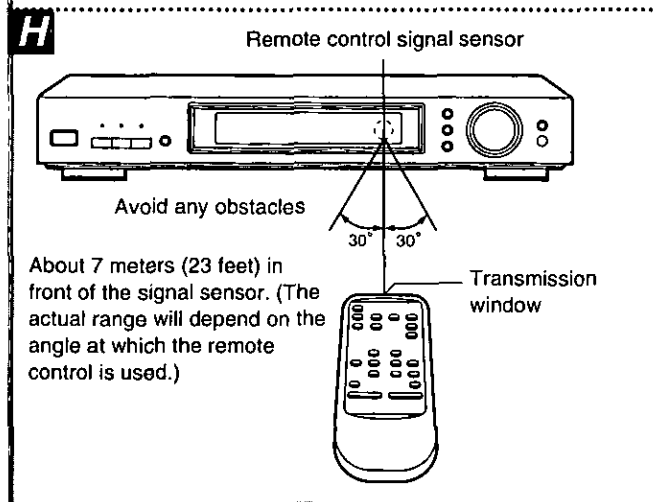
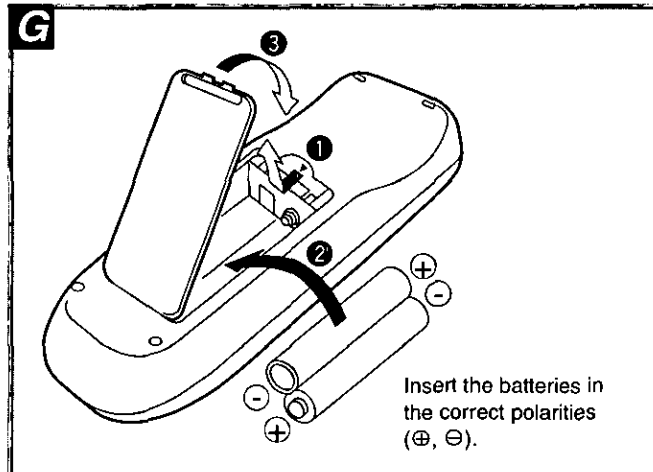
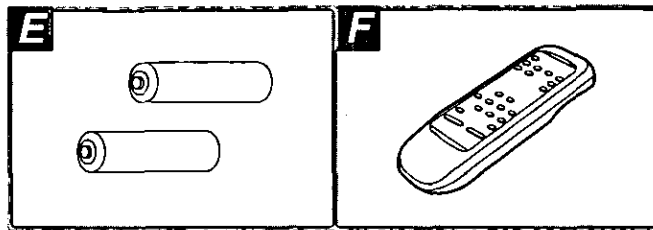
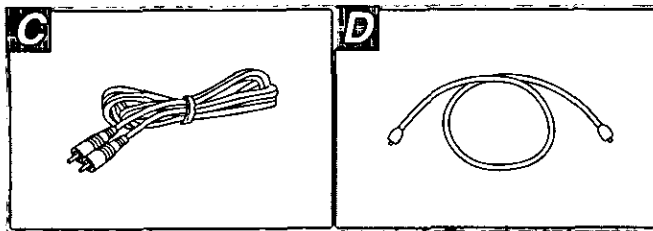
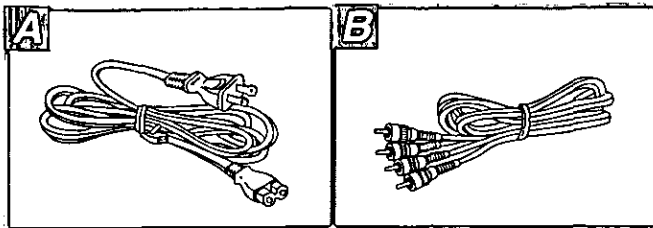

Accessories

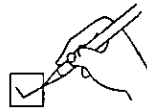

Please check and identify the supplied accessories.

- A** AC power supply cord (SJA175-A)1 pc.
- B** Stereo connection cables (RJL2P004B08)2 pcs.
- C** Monaural connection cables (RJL1P021B08)2 pcs.
- D** Optical-fiber cable (SJP2281)1 pc.
- E** Batteries2 pcs.
- F** Remote control transmitter (EUR645403)1 pc.

Use numbers indicated in parentheses when asking for replacement parts.

(Only for U.S.A.)

To order accessories contact 1-800-332-5368 or web site (<http://www.panasonic.com>).

Concerning the remote control

Battery installation

- Thoroughly clean the battery compartment before inserting new batteries.
- Do not mix old and new batteries, or batteries of different types (carbon and alkaline, etc.).
- If you will not use the remote control for a long period of time, remove the batteries and store them in a cool, dark place.
- Do not use rechargeable type batteries.
- Do not attempt to recharge alkaline or carbon batteries.
- Always remove old, weak or worn-out batteries promptly and dispose of them properly.
- Never subject batteries to excessive heat or flame; do not attempt to disassemble them; and be sure they are not short-circuited.
- If leaking electrolyte comes into contact with skin or clothes, flush with water immediately.

When you need to replace these batteries

Use two R6/LR6, AA, UM-3 batteries.

Method for use

Note

Be sure the transmission window and the signal sensor are free from dust. Excessive dust might effect performance.

Operation may not be correct if direct sunlight or other strong light source strikes the signal sensor of this unit. If there is a problem, place the unit away from the light source.

Front panel controls

Control section **A**

Ref. page(s)

- ① Power button (POWER) 10
- ② Input select buttons/indicators
(DIGITAL 1, DIGITAL 2, DIGITAL 3, LINE)..... 15
- ③ Surround mode button (SURROUND) ..11, 13, 15
- ④ Digital Theater Systems mode button (DTS) ...15
- ⑤ Stereo mode button (STEREO) 15
- ⑥ Volume control (VOLUME)11, 16

Main unit only

- ⑦ Speaker setting buttons
(CHANNEL/SET, SELECTOR)..... 10

Remote control only

- ⑧ Dynamic range compression button
(DR COMP) 17
- ⑨ Balance control (L, R)..... 12
- ⑩ Output level setting buttons
(TEST, LEVEL, -, +) 12
- ⑪ Delay time setting buttons (DELAY, -, +)..... 13
- ⑫ Dimmer button (DIMMER)..... 17
- ⑬ Muting button (MUTING)..... 17

Display section **B**

Ref. page(s)

- ⑭ Standby indicator (STANDBY, ■)

With the POWER button in the ON position (), the unit can be switched between the STANDBY and ON condition using the remote control and in this STANDBY condition the indicator will light.

- ⑮ Surround format indicators
( DIGITAL,  DTS,  PRO LOGIC) 16

- ⑯ Display

- ⑰ Dynamic range compression indicator
(DR COMP)..... 17

- ⑱ Speaker indicators 9, 10, 12, 13

Light in accordance with the speaker setting, and each of the indicators corresponding with the speaker concerned flashes when;

- the type or presence of that speaker is set,
- the test signal is output from that speaker,
- the output level or delay time of that speaker is adjusted.

- ⑲ Signal format indicators (LS, C, RS, L, R, S, LFE)

These indicators light up to indicate the Dolby Digital or DTS input signal format.

LS: Surround speaker (left)

C: Center speaker

RS: Surround speaker (right)

L: Front speaker (left)

R: Front speaker (right)

"S" represents the mono surround and "LFE" (Low Frequency Effect) is a channel for the deep-bass effect in the low frequency range.

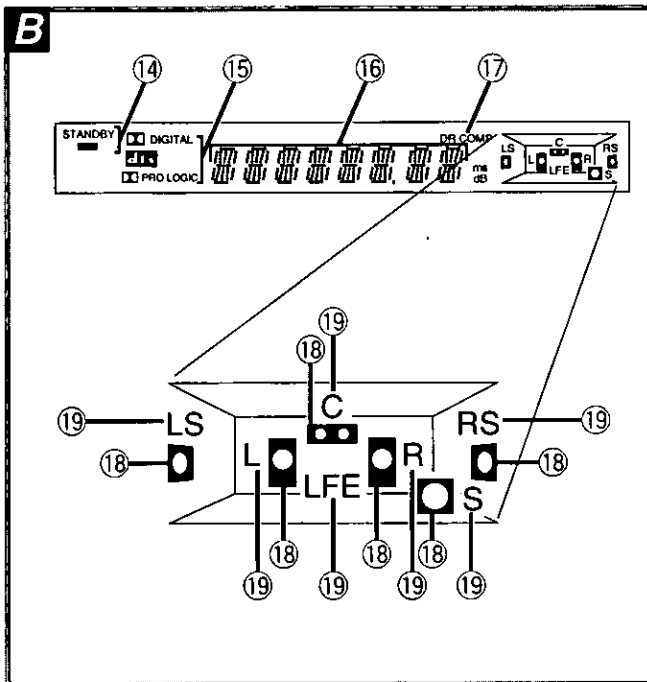
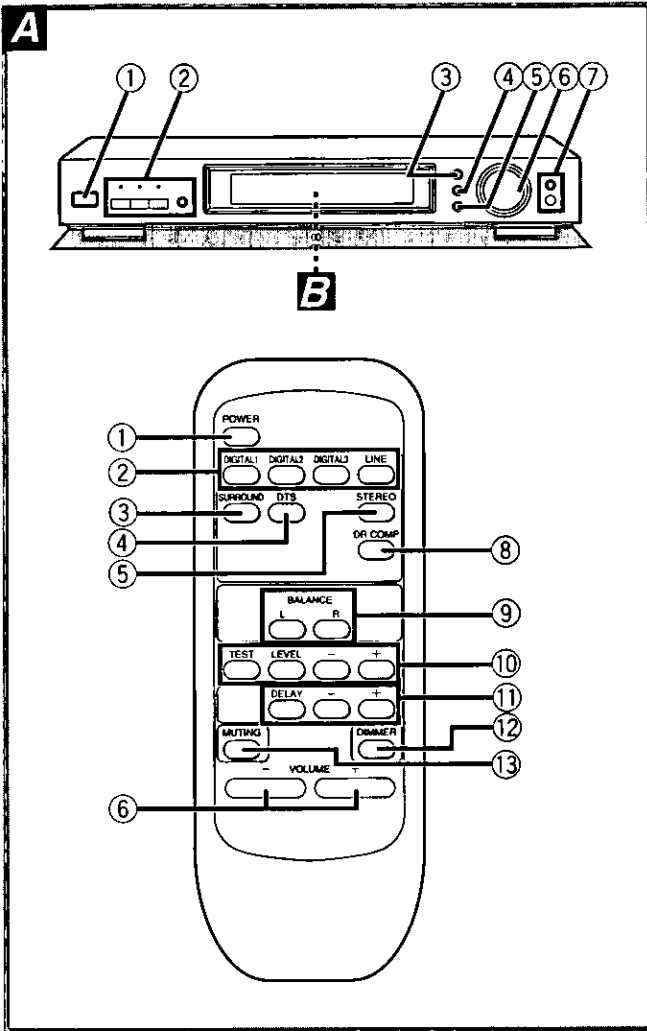

Connections

Before proceeding with the connections, ensure that the power to all the units has been turned off.

Connect the AC power supply cord only after all other cables and cords are connected.

Stereo connection cable

White (L)
Red (R)

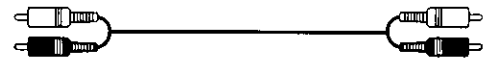

Connection to a receiver or amplifier

Connection to a receiver (or amplifier) with 6 channel discrete input terminals

SH-AC500D

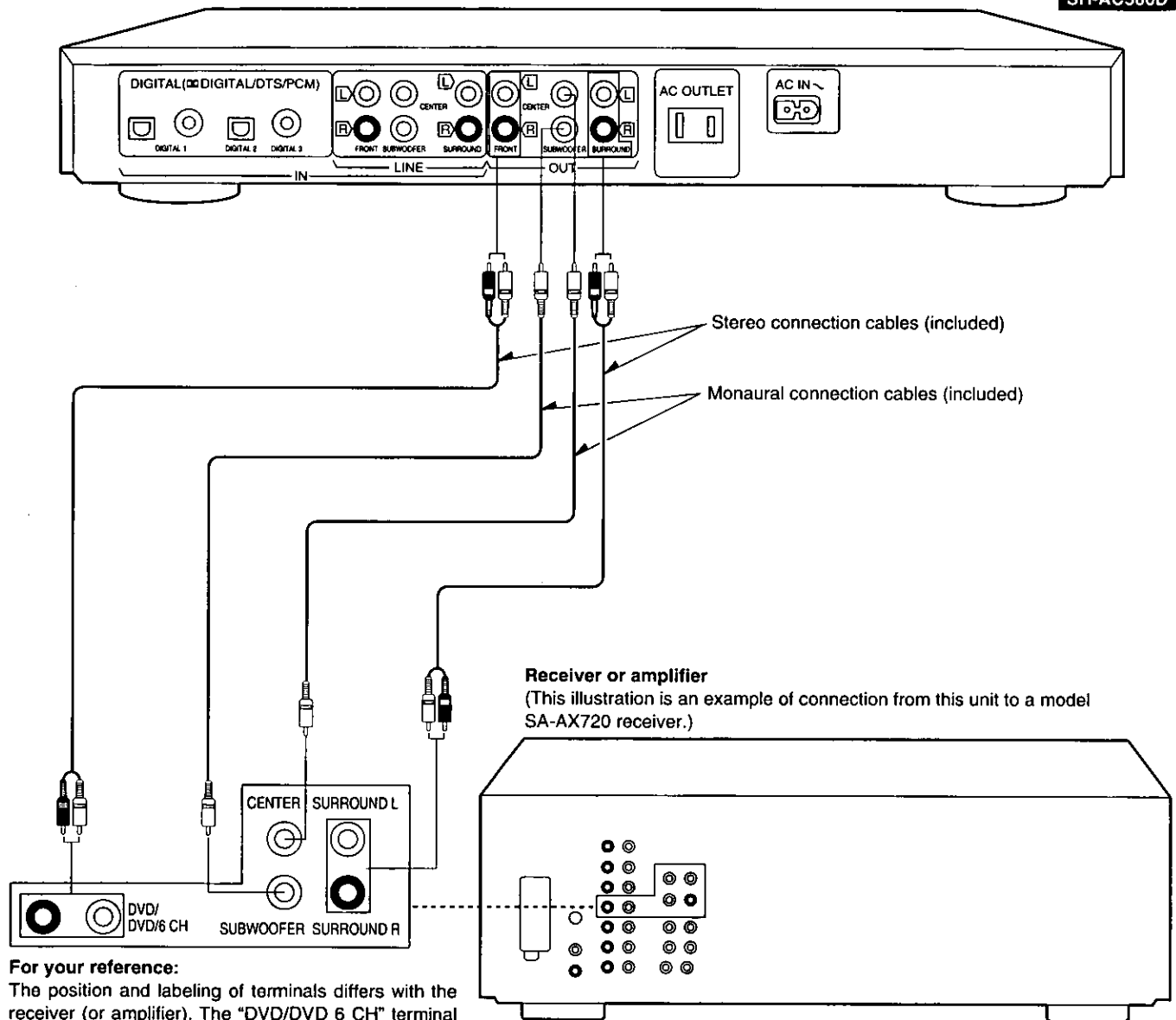

Receiver or amplifier

(This illustration is an example of connection from this unit to a model SA-AX720 receiver.)

For your reference:

The position and labeling of terminals differs with the receiver (or amplifier). The "DVD/DVD 6 CH" terminal in the above illustration, for example, is often labeled as "FRONT (L, R)."

Connections for outputting the 6 channel signals through 3 power amplifiers

This illustration is an example of connection from this unit to a stereo control amplifier of model SU-C1000 and three stereo power amplifiers of model SE-A1000.

SH-AC500D

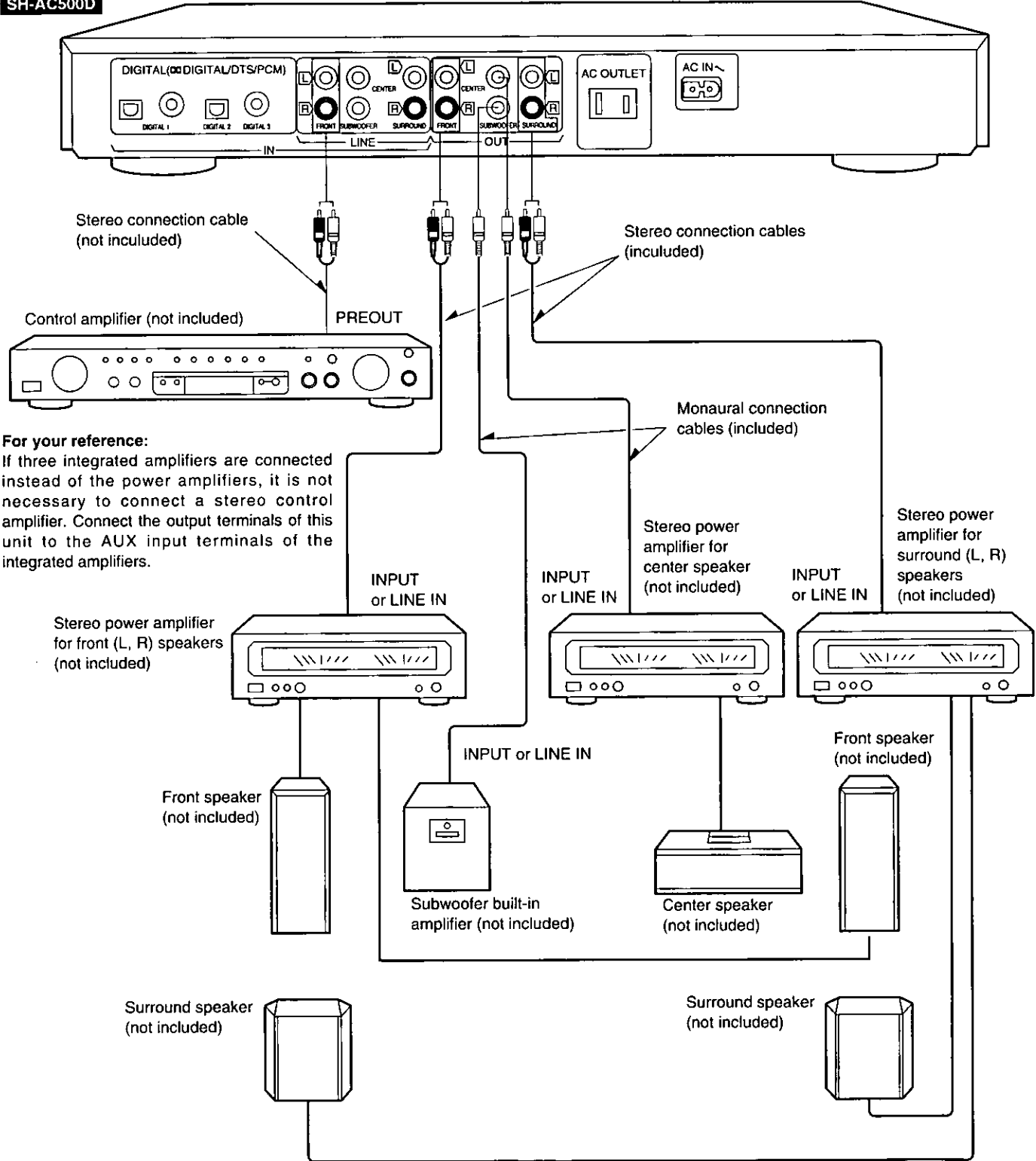

For your reference:
 If three integrated amplifiers are connected instead of the power amplifiers, it is not necessary to connect a stereo control amplifier. Connect the output terminals of this unit to the AUX input terminals of the integrated amplifiers.

Connections to audio-visual equipment and the AC power cord

Before use

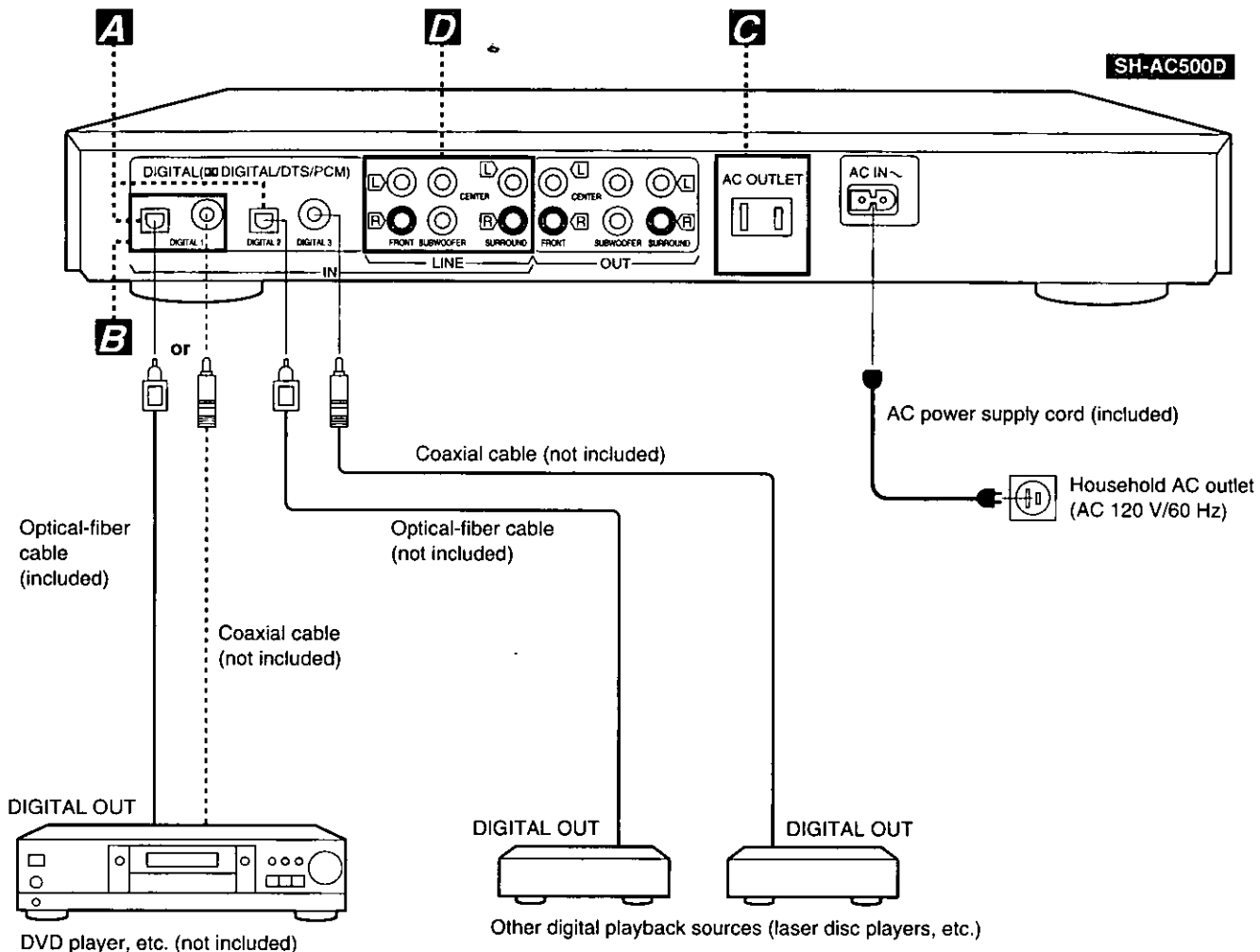

Connection for optical-fiber cable A

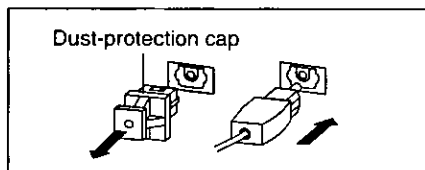

Note

- Do not bend the optical-fiber cable at a sharp angle.
- If the digital optical connector is not going to be used, be sure to attach the dust-protection cap to prevent exposure to dust.

“DIGITAL 1” terminals B

Disconnect the coaxial cable from the DIGITAL 1 terminal when using an optical fiber cable. Only the coaxial cable is recognized if both types are connected.

“UNSWITCHED” AC outlet C

This is for the exclusive use of an audio component. It can be used to supply power to a component regardless of whether the unit's POWER button is at the ON or OFF position. Use it for any unit having a rating of 50 W or less.

“LINE IN” terminals D

(Only if a control amplifier has not been connected.)

You can connect a set-top box tuner for digital television or similar decoder.

If “LINE” is selected with the input selector on this unit, the signals received through these terminals are output as they are without passing through any sound control circuits (i.e. no volume or other sound adjustments can be made with this unit.)

Note

- Dolby Digital RF (radio frequency) signals cannot be decoded with this unit even if a unit that has Dolby Digital RF output terminals is connected to this unit.
- Turn off the power to this unit if unusual hissing or beat sounds are heard while listening to FM, AM, or television broadcasts.

Speaker installation

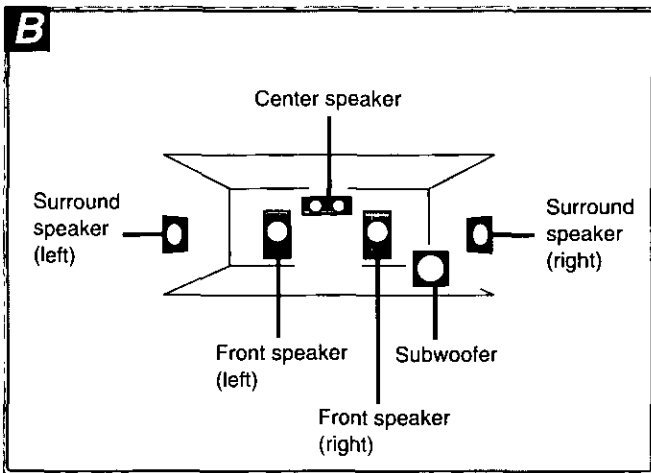
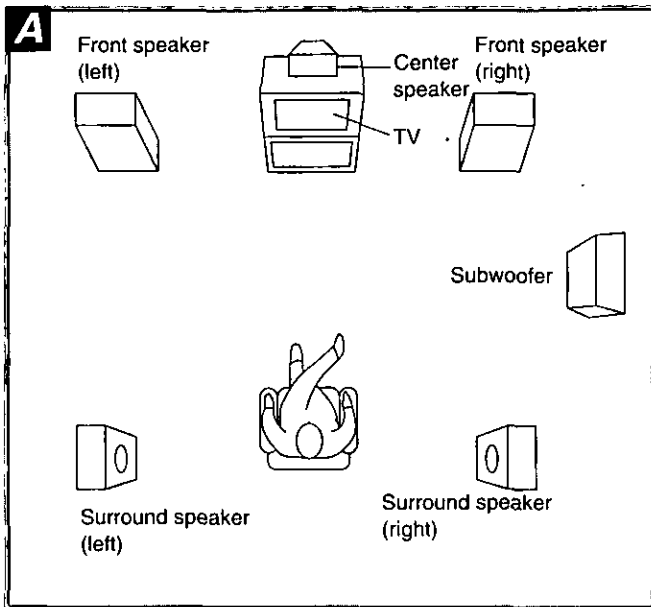

To enjoy discrete multi-channel sound reproduction using this unit, read through the instructions given below before installing the speakers. **A**

Front speakers

Place these speakers on the left and right of the TV (or screen), and adjust their positions and angles so that the movement of the images perfectly matches the movement of the sound at the viewing and listening position.

Center speaker

Install this speaker above or below the center of the TV (or screen) and point it directly at the viewing or listening position.

Surround speakers

Place these speakers at the side and slightly behind you at a height of about one meter above the level of your ears.

Subwoofer

Place this speaker in a suitable position, not too far away from the TV (or screen).

When it comes to the localization of the subwoofer's sound images, there is no significant difference in terms of the effect obtained by the positioning of the speaker. However, with a little effort and plenty of trial positioning, it is possible to achieve a smoother frequency response in the low frequency range. For instance, the bass volume will be boosted (although it may sound somewhat unnatural) by placing the speaker in the corner of the room.

Speaker indicators light in accordance with the speaker setting. **B**

Note

Do not run speaker cords near the power cords since this may generate noise.

For your reference:

When the center or surround speakers are not used, the corresponding signals are assigned through the available channels, customizing the sound to suit your speaker setup. This is not done, however, if the source is DTS format. (⇒ Refer to page 10.)

Using this unit

It is necessary to make various settings before enjoying audio/video sources. Carry out the settings in the following order.

Speaker settings (⇒ page 10)

Enter the types of speakers being used.



Speaker output adjustments (⇒ page 11)

Set the level of output to be sent to the receiver (or amplifier) for each speaker channel.



Delay time adjustments (⇒ page 13)

Set the delay time for each speaker channel.



Start playback of the source. (⇒ pages 14–17)

Speaker setting

Set the types and presence of the speakers before enjoying the sound by reproducing the input source.

Before proceeding:

Check the frequency range of each speaker to be used. Consider speakers capable of playing back low frequency sounds (below around 100 Hz) as **LARGE**. Consider speakers not capable of playing back low frequency sounds as **SMALL**.

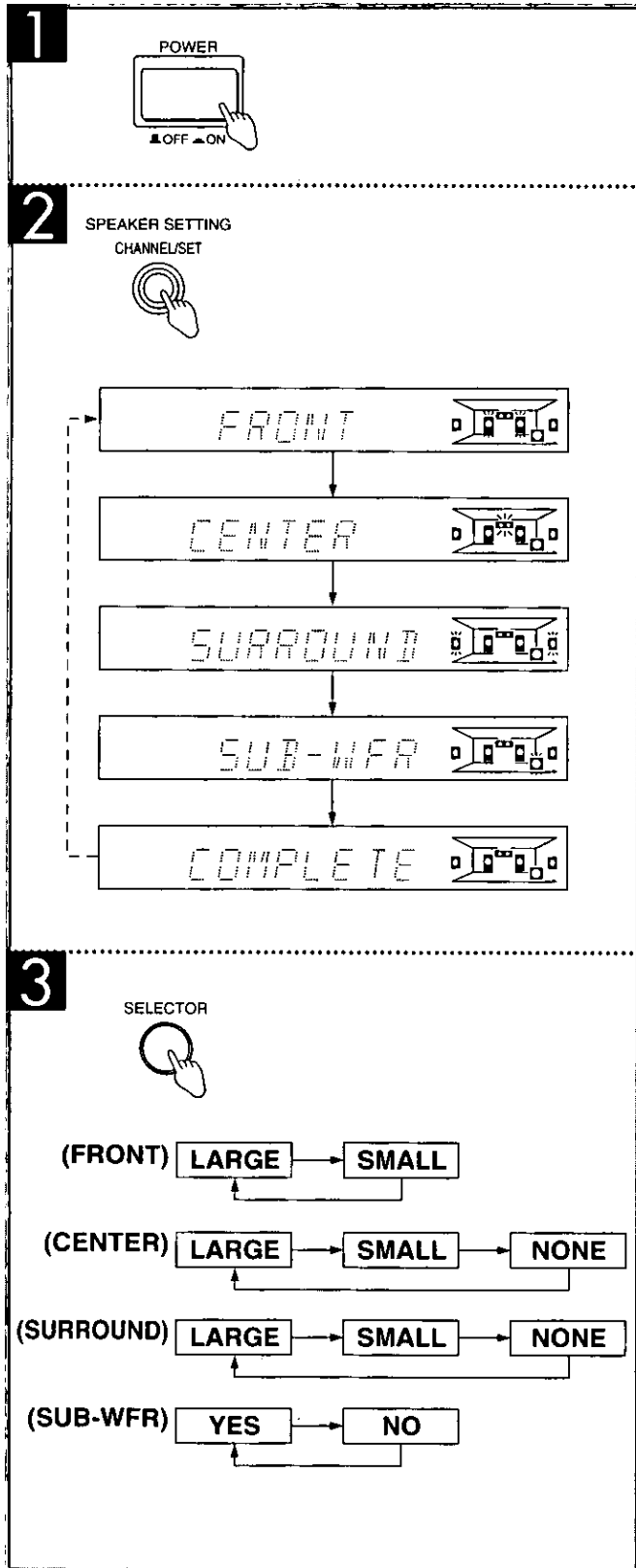
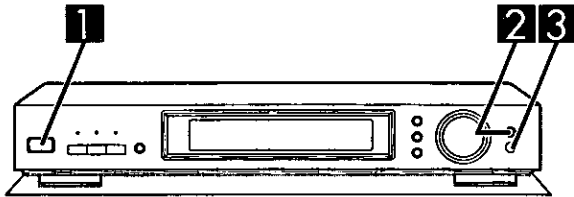

1 Press **POWER**.

2 Press **CHANNEL/SET**, and select the channel for which the speaker is to be set.

Each time the button is pressed, the channel display is switched in the listed order.

FRONT: Front speakers **CENTER:** Center speaker

SURROUND: Surround speaker **SUB-WFR:** Subwoofer

COMPLETE: Select this when you have completed the settings.

The selected channel is shown on the display for approx. 2 seconds. The current setting for that channel is then shown as a flashing display. The indicator corresponding to the selected speaker also continues to flash.

3 Press **SELECTOR**, and set the type (**LARGE**, **SMALL**) and presence (**YES**, **NO** or **NONE**) of the speaker.

Each time the button is pressed, the display is switched in the listed order.

LARGE: select if the speaker can produce low frequency sounds,

SMALL: select if the speaker cannot produce low frequency sounds,

NONE: select if you are not using a center speaker or surround speakers,

YES: select if you are using a subwoofer,

NO: select if you are not using a subwoofer.

The sound for speaker channels that are set to "NONE" or "NO" are output from the front speakers. DTS format software, however, depends upon all channels being operable, and so the sound for speakers not connected is not heard at all, no matter what settings are made.

4 Repeat steps 2 and 3 to complete the settings for all the channels.

5 Press **CHANNEL/SET** to select "**COMPLETE**".

The settings are now entered into the unit's memory. The display goes out after about 2 seconds and the previous display reappears.

The speaker indicators light up unless "NONE" or "NO" has been selected for the corresponding channel.

Note

If no buttons are pressed for approx. 10 seconds during the setting process, all previous settings are canceled, the setting mode is released, and the original display is restored. Begin the setting process again if this occurs.

For your reference:

The setting remains as it is until changed by the above procedure, even after the power has been turned off.

Speaker output adjustments

Set the initial output level first, then proceed to adjust the output level for each speaker channel.

Setting the initial volume level

When this unit is connected to a receiver (or amplifier) that has 6 channel discrete input terminals:

- 1** Set the volume level to 0 dB using this unit's VOLUME control. **A**
- 2** Set the volume control of the receiver (or amplifier) to the position normally used for enjoying the source.

If the test signal, described below in "Speaker output adjustment", is too soft, adjust the volume on the receiver (or amplifier).

Note

If the input level to the receiver (or amplifier) is too loud, lower the volume level using this unit's VOLUME control.

When this unit is connected to three standard stereo amplifiers:

- 1** Set the volume level to around -48 dB using this unit's VOLUME control. **B**

(If this unit is connected to three integrated amplifiers:)

- 2** Set the volume control of the integrated amplifiers to the position normally used for enjoying the source.

If the test signal, described below in "Speaker output adjustment", is too soft or too loud, adjust the volume on this unit.

Adjust the output level of each speaker **Remote control only**

Use the test signal to adjust the output level of the center speaker, surround speakers and subwoofer.

Note

If the output from the front speakers is unbalanced, make balance adjustments on the receiver or amplifier before continuing with the following. (Refer to the instruction manual of the component.)

If the receiver or amplifier cannot be used to make balance adjustments, they can be made on this unit (➔ see page 12).

- 3** Press SURROUND to select the surround mode.
"SURROUND" appears on the display.

(Continued on next page)

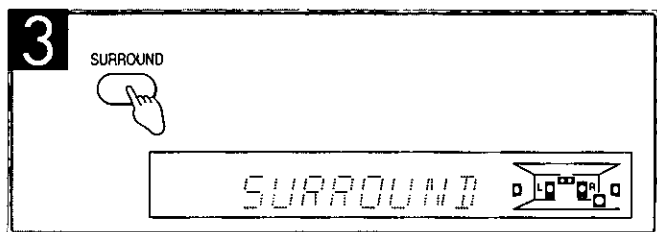
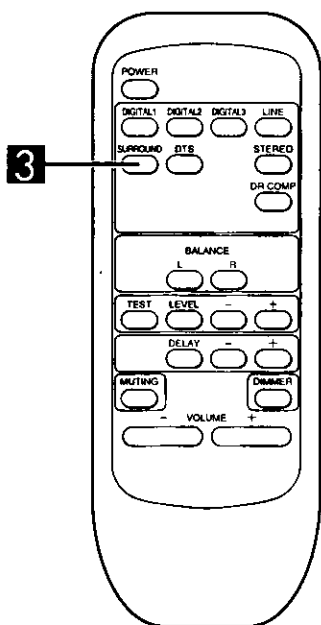
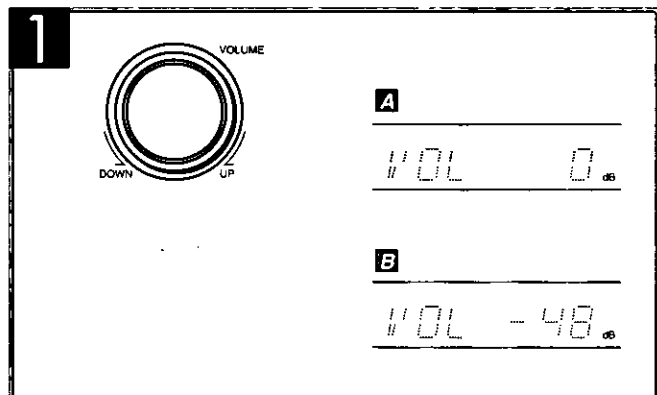

Speaker output adjustments

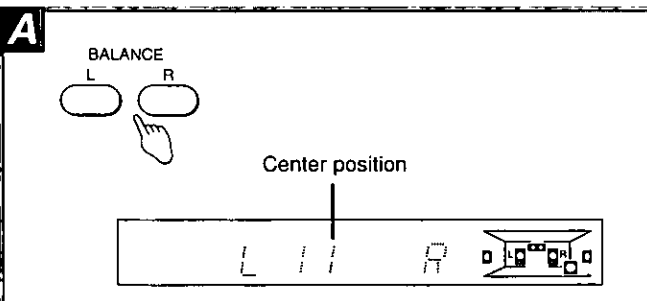
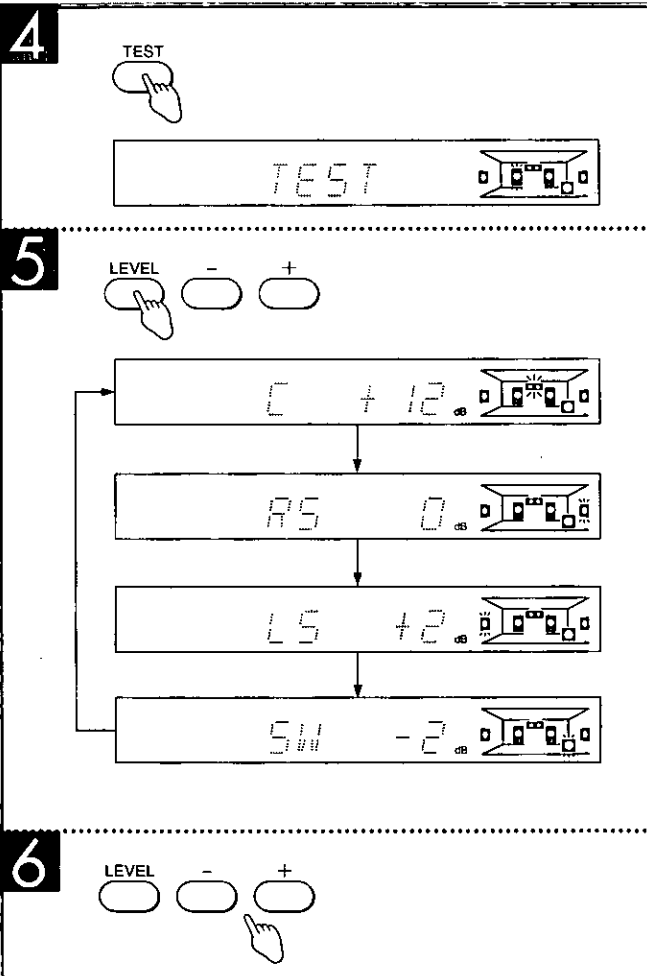
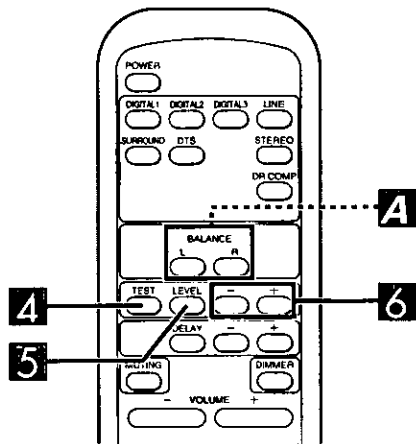

4 Press TEST to output the test signal.

"TEST" appears on the display, and the speaker indicator corresponding to the speaker whose outputting sound flashes.

The test signal is automatically output from each speaker for 2 seconds in the following sequence:

L → C → R → RS → LS → SW

L: Front speaker (left)
 C: Center speaker
 R: Front speaker (right)
 RS: Surround speaker (right)
 LS: Surround speaker (left)
 SW: Subwoofer
 (Speakers for which NONE or NO has been set are skipped.)

Note

If the left and right front speaker balance is poor, do not proceed with the next step until balance has been improved with the procedure described below (A).

5 Press LEVEL to select the speaker channel to adjust.

The output level appears on the display, and the speaker indicator for the selected speaker flashes.

Each time the button is subsequently pressed, the speaker whose level is to be set is selected in the listed sequence.
 (Speakers for which NONE or NO has been set are skipped.)

6 Press LEVEL [-] or [+] to adjust the output level.

Channels C, RS, LS, and SW can be adjusted between -12 dB and +12 dB. Set them so that the output from each channel appears to be the same as that from the front speakers.

7 Repeat steps 5 and 6 to adjust the output of each channel to approximately the same apparent level.

To stop the test signal

Press TEST.

Using this unit to adjust the balance of the left and right front speakers A

Make the adjustments while listening to the test signal put out in step 4 above.

Press BALANCE [L] or [R] on the remote control to adjust the level balance.

The left/right balance appears on the display.

Each time the button is subsequently pressed, the output level of the front speaker opposite to the button pressed is decreased. (i.e. when the L button is pressed, the output level of the R speaker is decreased.)

The original display is restored if a button isn't pressed for 4 or more seconds.

Note

The balance of the surround speakers cannot be adjusted using the BALANCE buttons.

Delay time adjustments

By adjusting the delay time, the difference in the distance from the viewing and listening position to the front speakers and the distance to the center speaker and surround speakers can be offset and made equal. This achieves better sound localization and makes a more life-like reproduction of the sound field possible.

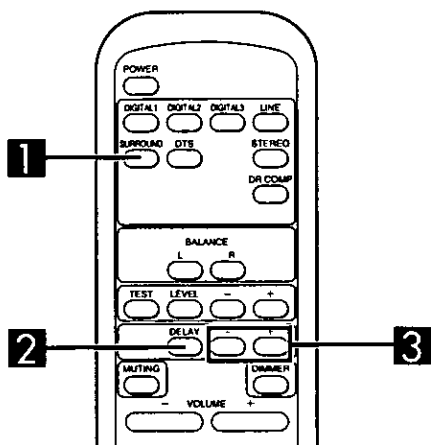

Remote control only

- 1 Press **SURROUND** to select the surround mode.

"SURROUND" appears on the display.

- 2 Press **DELAY** to select the channel to be adjusted.

Each time the button is subsequently pressed, the channel whose delay time is to be set is selected alternately: C (Center speaker) ↔ S (Surround speakers)

For each channel, the delay time is displayed, and the speaker indicator for the corresponding speaker flashes. The display is restored if a button isn't pressed for 4 or more seconds.

Note

Speakers for which NONE has been set are skipped.

- 3 Press **[-]** or **[+]** to set the delay time.

When the button is pressed, the current delay time is displayed. Each time the button is pressed, the delay time will change. The delay time increments are different depending on the speaker as follows.

Speaker	Available delay time setting (ms)
Center	0, 1, 2, 3, 4, 5
Surround	0, 5, 10, 15

Note

Please note the following if delay time is adjusted while playing back a source:

Adjustment is not possible if the source is DTS format.

While the **PRO LOGIC** indicator is alight, the center channel cannot be adjusted and 15 ms are added to the delay times listed for the surround channel when displayed.

To calculate the delay time **A**

- D₁: Distance from front speaker
- D₂: Distance from surround speaker
- D₃: Distance from center speaker

Setting the center channel delay time:

If D ₁ is equal to or less than D ₃	Set to 0 ms
If D ₃ less than D ₁	Increase 1 ms for every 30 cm (1 feet) of difference between D ₁ and D ₃

Setting the surround channel delay time:

If D ₁ is equal to or less than D ₂	Set to 0 ms
If D ₂ is less than D ₁	Start at 0 ms and increase by 5 ms for every 1.5 m (5 feet) of difference between D ₁ and D ₂

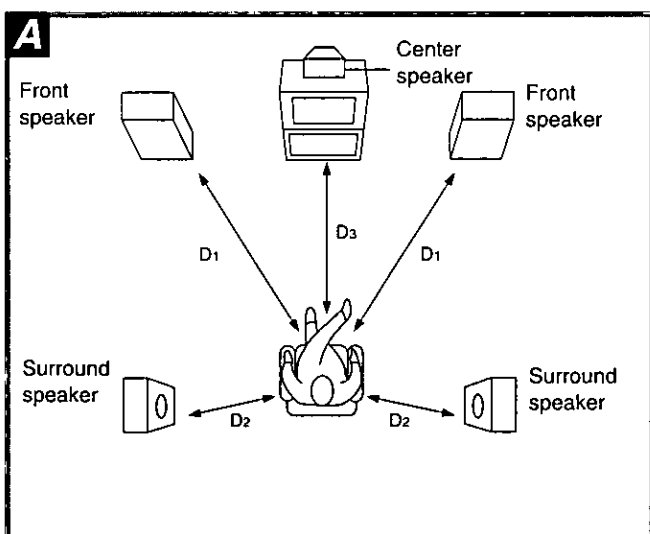
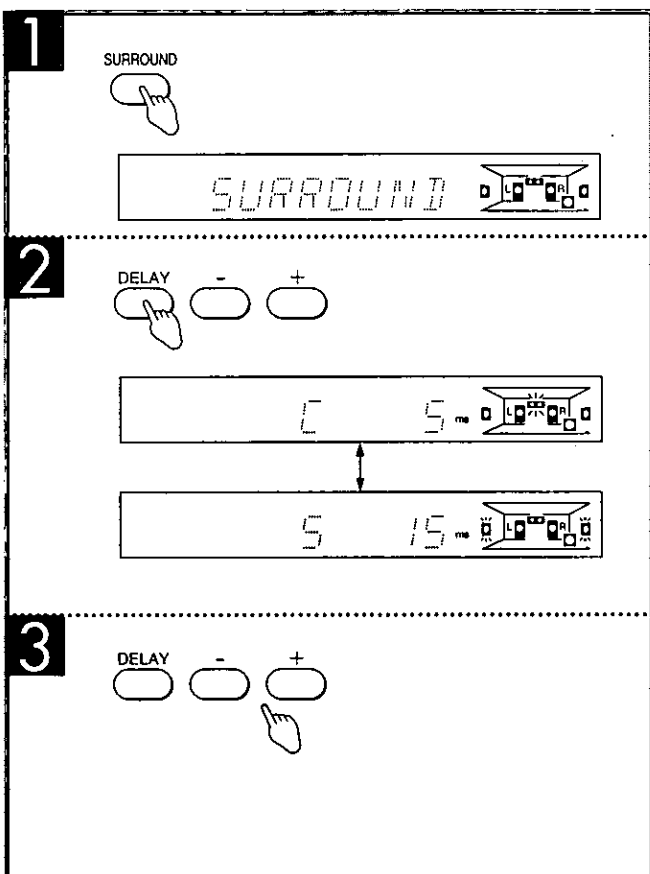

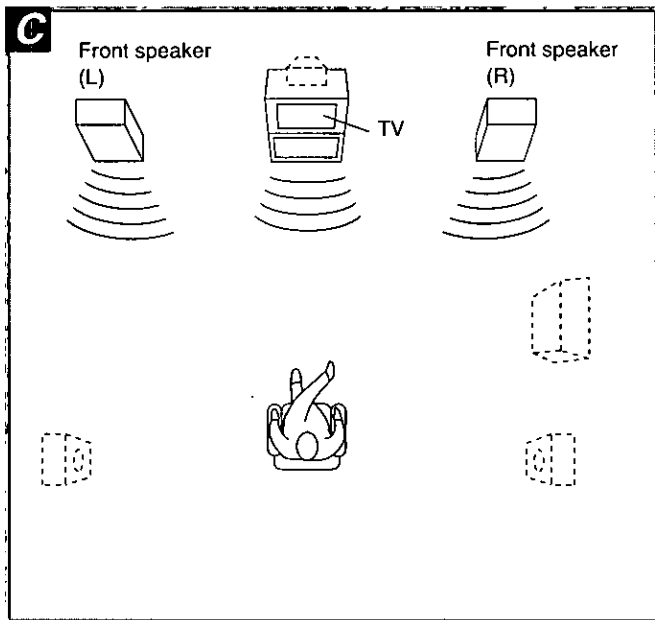
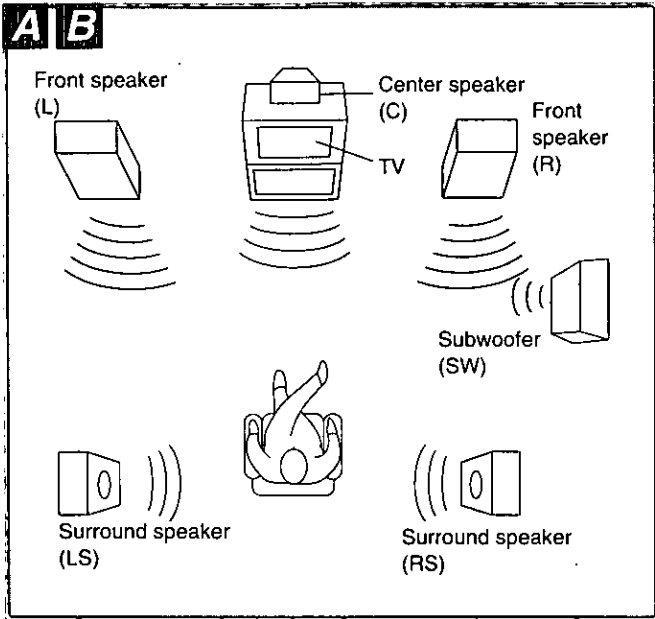

Reproduction modes

All the reproduction modes mentioned below can be effective only when digital signals are input as a sound source.

SURROUND mode **A**

Select this mode when playing back sources (DVD, CD, laser disc, etc.) recorded in either Dolby Digital or Dolby Surround Format. The unit processes most types automatically.

Normal audio CDs can also be played back. The unit processes the 2 channel signal into surround signals and sound is heard from all the speakers.

As well as normal audio CDs, software with any of the following marks can be played back in this mode.



DTS mode **B**

Select this mode when playing back sources (DVD, CD, laser disc, etc.) recorded in DTS format.

Software with the following mark can be played back in this mode.



STEREO mode **C**

Select this mode to listen to surround sources, other than DTS, in stereo. The down-mix function of this unit concentrates the discrete signals into the front L/R channels. Use this mode when using headphones or recording onto a video cassette recorder.

Select this mode to listen to normal stereo software.

Note

DTS cannot be down-mixed.

Manufactured under license from Dolby Laboratories. "Dolby", "Pro Logic" and the double-D symbol are trademarks of Dolby Laboratories. Confidential Unpublished Works. © 1992-1997 Dolby Laboratories, Inc. All rights reserved.

DTS Inc. USP No. 5, 451, 942.

Enjoying sound in a variety of reproduction modes

This unit enables sound to be enjoyed in three reproduction modes – SURROUND, DTS and STEREO.

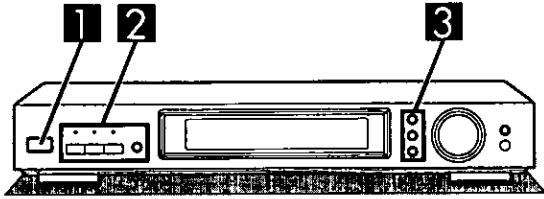

1 Press POWER.
Turn on the power to the other AV components as well.

2 Press one of the input select buttons to select the input source.
The indicator above the pressed button now lights.

DIGITAL 1: Selects the source connected to the DIGITAL 1 terminal. The unit automatically recognizes whether the source is connected through the optical fiber cable or the coaxial cable.

Note

If both types are connected at the same time, only the coaxial cable is recognized. Disconnect the coaxial cable if the external unit is connected with the optical fiber cable.

DIGITAL 2: Selects the source connected to this terminal.

DIGITAL 3: Selects the source connected to this terminal.

LINE: Selects the source connected to the LINE terminal. If a control amp has been connected to the LINE terminal, select the input source on it as well.

When DIGITAL 1, 2 or 3 has been selected:

The reproduction modes in step 3 can be selected.

When LINE has been selected:

The analog sound signals input through LINE IN terminals are directly output to the left and right front speakers via the connected component. "THROUGH" appears on the display.

Note

Only the POWER button and select buttons function when LINE has been selected.

3 Press SURROUND, DTS or STEREO to select the reproduction mode.

The selected reproduction mode appears on the display (→ see the previous page for descriptions of the modes.)

4 (When this unit is connected to a receiver (or amplifier) that 6 channel discrete input terminals:)

Set the receiver (or amplifier) to the 6 channel discrete input mode.

Note

If this unit is connected to three integrated amplifiers, set the input selector on the amplifiers to the connected input terminal such as the "AUX" terminals.

(Refer to the instruction manuals of the components.)

(Continued on next page)

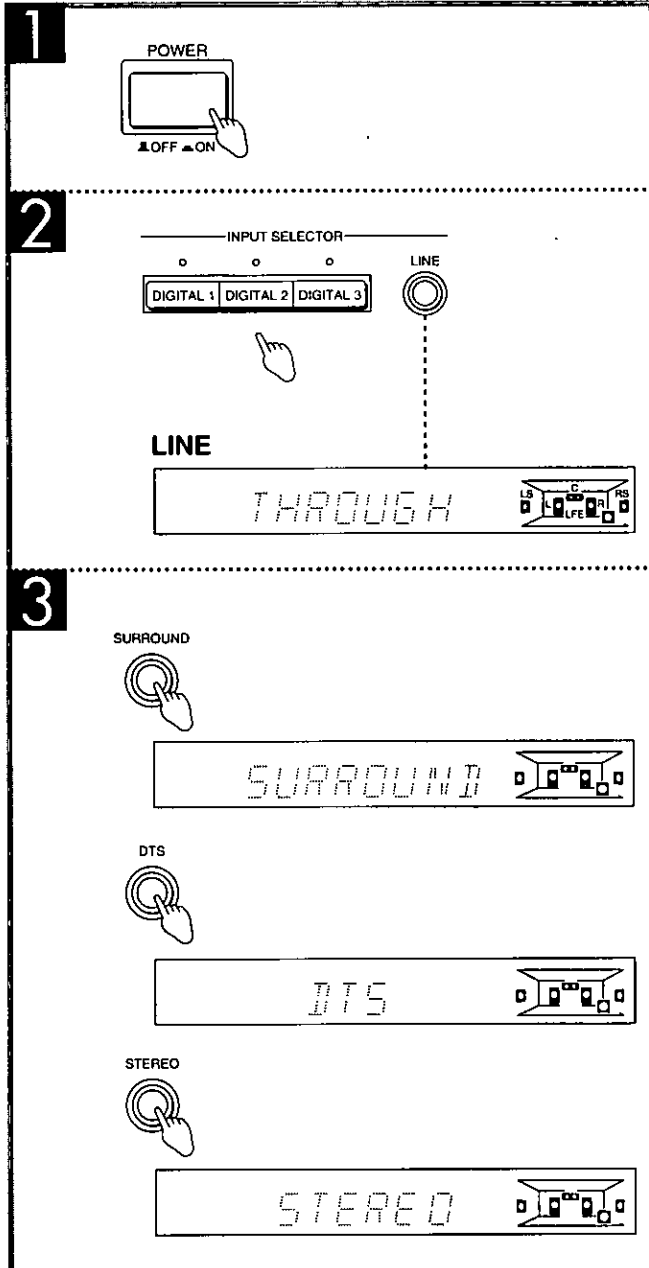

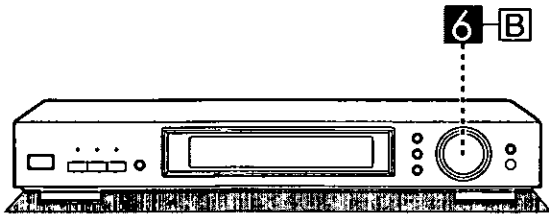

5

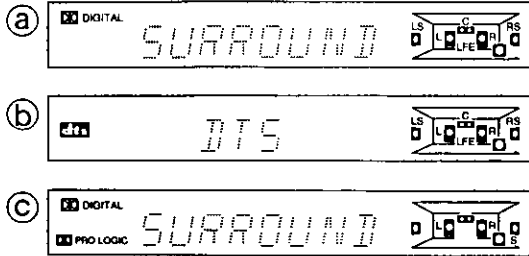

6-B

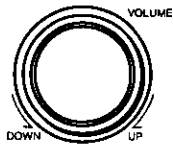

5 Start playing the sound source.

The surround indicators

- Ⓐ DIGITAL: Lights if the source is Dolby Digital Format.
- Ⓑ DTS: Lights if the source is DTS format.
- Ⓒ PRO LOGIC: Lights when Dolby Surround parts of Dolby Digital format software are played back, or when playing audio CDs in the SURROUND mode.

Note

- Only Dolby Digital, DTS or PCM signals ※ can be reproduced.
The digital input signal of sampling frequencies 96 kHz and other signal formats such as MPEG cannot be reproduced on this unit.
- When playback is started, the sound may be cut or interrupted before the input source is confirmed as Dolby Digital or DTS.

※ **PCM signal:** This refers to the recording format of signals (44.1 kHz, linear 16 bits) used for audio CDs

6 Adjust the volume.

Set the volume on the receiver (or amplifier) and this unit to the initial level (➡ see page 11). Any subsequent volume adjustments should be done as follows.

Ⓐ (When this unit is connected to a receiver (or amplifier) that has 6 channel discrete input terminals:)

Adjust the volume using the volume control on the receiver (or amplifier).

If input to the receiver (or amplifier) is excessive, reduce the volume on this unit slightly.

Ⓑ (When this unit is connected to three standard stereo amplifiers or three integrated amplifiers:)

Adjust the volume using this unit's VOLUME control.

To adjust the volume of the components connected to the stereo control amplifier, use the volume control on the stereo control amplifier.

After use

Reduce the volume on the component you are using to control the volume (the receiver, amplifier or this unit) to the minimum level, then turn off the power to this unit and the other components.

Other functions

Setting the midnight mode (dynamic range compression)

"Dynamic range compression" (DR COMP) is a function for compressing the dynamic range (reproduction level range) of audio signals. It is used for viewing movie software late at night or at other times when high volume levels are not desirable.

This function only works with DR COMP compatible Dolby Digital format software.

Remote control only

Press DR COMP. **A**

The "DR COMP" indicator lights.

When the button is pressed again, the function is released, and the indicator goes off.

For your reference:

When DR COMP is on, scenes that already have a low sound level will be heard as they are. When scenes that are loud occur, the function acts to reduce the peak level.

The sound field will remain intact even if DR COMP is functioning.

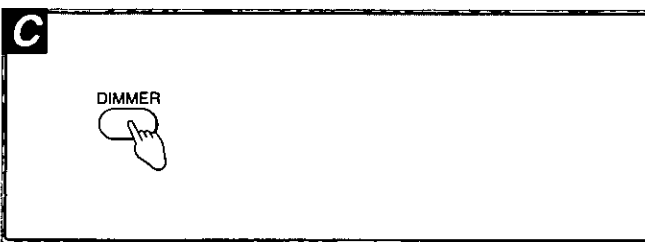
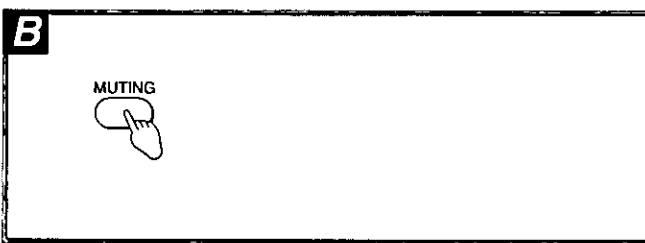
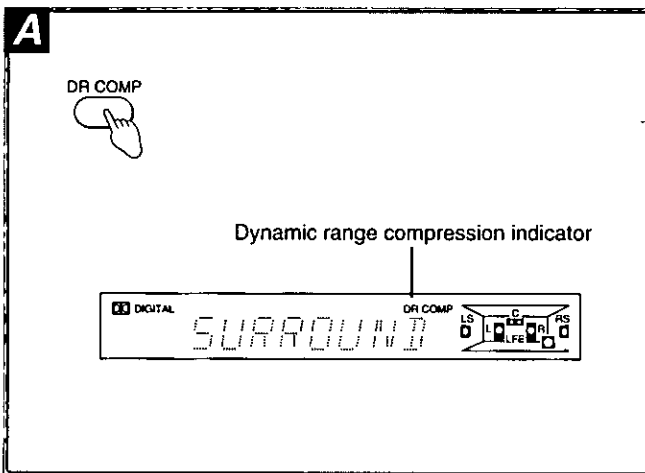
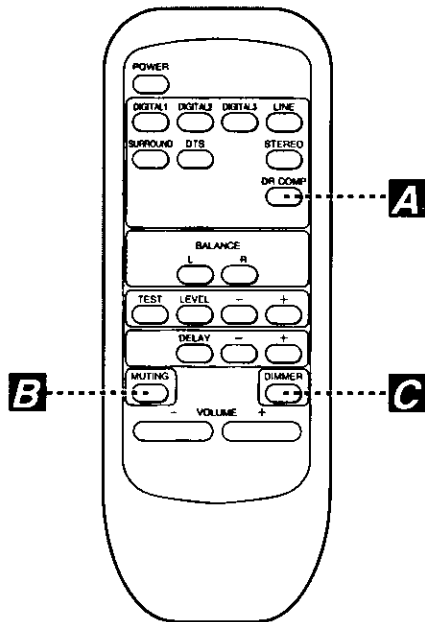

Muting the sound temporarily

Remote control only

Press MUTING. **B**

During muting, the message "MUTING ON NOW" scrolls across the display.

When the button is pressed again, the original volume level is restored. When the unit's power is switched off, muting is canceled.

Selecting the display panel brightness

Remote control only

Press DIMMER. **C**

The display panel is dimmed.

When the button is pressed again, or when the unit's power is switched off, the original brightness is restored.

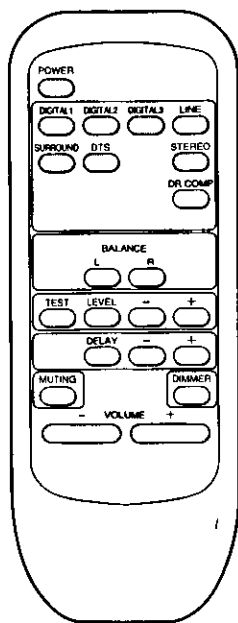

Functions which are also available from the main unit

To turn the unit ON/OFF	POWER
Selecting the input source	DIGITAL 1 DIGITAL 2 DIGITAL 3 LINE
Selecting the SURROUND reproduction mode	SURROUND
Selecting the DTS reproduction mode	DTS
Selecting the STEREO reproduction mode	STEREO
Adjusting the volume	- VOLUME +

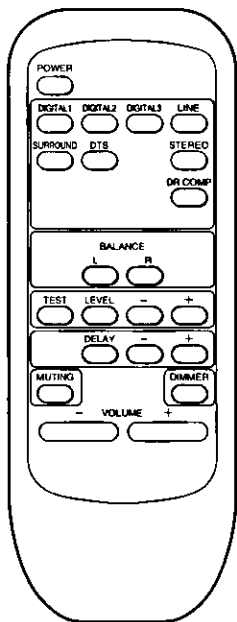

Functions which are only available from the remote control

To turn on the midnight mode	DR COMP
Adjusting the volume balance between the left and right front speakers	BALANCE L R
Outputting the test signal to adjust the output level of each speaker	TEST
Selecting the speaker channel and adjusting its output level	LEVEL →
Selecting the speaker channel and adjusting its delay time	DELAY →
Muting the sound temporarily	MUTING
Selecting the display panel brightness	DIMMER

Troubleshooting guide

Before requesting service for this unit, check the chart below for a possible cause of the problem you are experiencing. Some simple checks or a minor adjustment on your part may eliminate the problem and restore proper operation.

If you are in doubt about some of the check points, or if the remedies indicated in the chart do not solve the problem, refer to the directory of Authorized Service Centers (enclosed with this unit) to locate a convenient service center, or consult your Technics dealer for instructions.

For detailed instructions, contact an authorized servicenter in the U.S.A. and Panasonic Canada Inc. Customer Care Center in Canada.

In the U.S.A. 1-800-211-7262 or web site

(<http://www.panasonic.com>)

In Canada 905-624-5505 or web site

(www.panasonic.ca/faq.html)

Problem	Probable cause(s)	Suggested remedy	Page
Power will not switch ON.	The power cord plug is not completely inserted.	<ul style="list-style-type: none"> Confirm that the power cord plug is connected completely. 	8
When listening to stereo sound, the left and right sounds are reversed.	The left and right stereo connection cables are reversed.	<ul style="list-style-type: none"> Check the connection cables are correctly connected. 	6, 7
Poor sound localization.	An error has been made with the connections to the 6 channel discrete input or output terminals.		
There is no sound when a source is being played.	The input selector setting is incorrect.	<ul style="list-style-type: none"> Check that the selection of the desired sound source is made correctly. 	15
	The muting function is set to ON.	<ul style="list-style-type: none"> Press the muting button on the remote control. 	17
Sound is not heard from one of the front speakers.	The volume balance of front speaker is set too far to one side, either left or right.	<ul style="list-style-type: none"> Adjust the volume balance between the left and right front speakers correctly. 	12
Sound is not heard from the center, surround or subwoofer speakers.	The receiver or amplifier is set to 2 channel (L, R) input.	<ul style="list-style-type: none"> Set the receiver or amplifier to the 6 channel discrete input mode. 	—
	The presence setting of the speaker has been incorrectly set to "NONE" or "NO".	<ul style="list-style-type: none"> Set the type and presence setting of each speaker correctly. 	10
The volume cannot be controlled.	The input selector is set to LINE.	<ul style="list-style-type: none"> Adjust the volume control on the external unit. 	—
There is noise when playing back a DTS source.	Play back a DTS formatted source in the SURROUND mode.	<ul style="list-style-type: none"> Select the DTS reproduction mode. 	15
The midnight mode does not function. (When the DR COMP button on the remote control is pressed, the DR COMP indicator does not light.)	The SURROUND mode has not selected.	<ul style="list-style-type: none"> Select the SURROUND mode. 	15
	The source being played has not been recorded in the Dolby Digital format.	<ul style="list-style-type: none"> Check if the <input type="checkbox"/> DIGITAL indicator is illuminated. 	16
"F70" appears on the display.		<ul style="list-style-type: none"> Turn off the power and then turn it on again, or disconnect the AC power supply cord and then connect it to your household AC outlet again. (If "F70" still remains on the display, consult an authorized service center or your dealer.) 	—
Remote control does not operate correctly.	The batteries have run out.	<ul style="list-style-type: none"> Replace batteries with new ones. 	4
	There is an obstruction between the remote control and this unit.	<ul style="list-style-type: none"> Remove the obstruction. 	
	The batteries are inserted incorrectly. [The (–) and (+) polarities are reversed.]	<ul style="list-style-type: none"> Reinsert batteries so that polarities are correct. 	

Product service

Do not attempt to remove the cover(s) or repair the unit yourself.
Refer servicing to qualified personnel only.

Product information

For product service, product information or assistance in product operation, refer to the servicenter directory.

Technical specifications

AUDIO

Outlet voltage/Impedance	2 V (at 0 dB)/1 k Ω
Input impedance	
LINE	22 k Ω
COAXIAL	75 Ω
Frequency response	
FRONT L/R, CENTER, SURROUND L/R (LARGE)	20 Hz–20 kHz, \pm 1 dB
Delay time	
DOLBY DIGITAL	
CENTER	0–5 ms
SURROUND L/R	0–15 ms
DOLBY PRO LOGIC	
SURROUND L/R	15–30 ms
Total harmonic distortion	
FRONT L/R (1 kHz, 0 dB, PCM)	0.007 %
Dynamic range	96 dB
S/N (IHF A)	100 dB
Load impedance	More than 10 k Ω

GENERAL

Power supply	AC 120 V, 60 Hz
Power consumption	15 W
Dimensions (W×H×D)	430×69.4×301.4 mm (16-15/16"×2-47/64"×11-55/64")
Weight	2.6 kg (5.7 lb.)

Note:

Specifications are subject to change without notice.
Weight and dimensions are approximate.

Panasonic Consumer Electronics
Company, Division of Matsushita
Electric Corporation of America
One Panasonic Way Secaucus,
New Jersey 07094
<http://www.panasonic.com>

Panasonic Sales Company,
Division of Matsushita Electric of
Puerto Rico, Inc. ("PSC")
Ave. 65 de Infantería. Km. 9.5
San Gabriel Industrial Park, Carolina,
Puerto Rico 00985

Panasonic Canada Inc.
5770 Ambler Drive,
Mississauga, Ontario
L4W 2T3
www.panasonic.ca

En

RQT4536-P

Free Manuals Download Website

<http://myh66.com>

<http://usermanuals.us>

<http://www.somanuals.com>

<http://www.4manuals.cc>

<http://www.manual-lib.com>

<http://www.404manual.com>

<http://www.luxmanual.com>

<http://aubethermostatmanual.com>

Golf course search by state

<http://golfingnear.com>

Email search by domain

<http://emailbydomain.com>

Auto manuals search

<http://auto.somanuals.com>

TV manuals search

<http://tv.somanuals.com>