

DVD Stereo System

Operating Instructions

Model No. **SC-DV290**

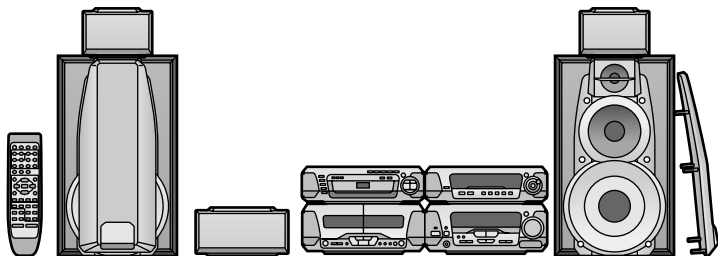

The illustration shows the model for the United Kingdom, Continental Europe and Russia.



Technics®

Region number supported by this player

Region numbers are allocated to DVD players and software according to where they are sold.

For the United Kingdom and Continental Europe

- The region number of this player is "2".
- The player will play DVD-Video marked with labels containing "2" or "ALL".

Example:



For Australia and N.Z.

- The region number of this player is "4".
- The player will play DVD-Video marked with labels containing "4" or "ALL".

Example:



For Russia

- The region number of this player is "5".
- The player will play DVD-Video marked with labels containing "5" or "ALL".

Example:



Note

"EB" on the outer packaging indicates the United Kingdom.

Before connecting, operating or adjusting this product, please read these instructions completely. Please keep this manual for future reference.

EB E EE GN

RQT6894-B

Dear customer

Thank you for purchasing this product.
For optimum performance and safety, please read these instructions carefully.

Unless otherwise indicated, illustrations in these operating instructions are of the system for the United Kingdom, Continental Europe and Russia.

System		SC-DV290
Sound processor		SH-DV290
Stereo tuner/amplifier		SA-DV290
DVD/Video CD/CD changer		SL-DV290
Stereo cassette deck		RS-DV290
Speakers	Front	SB-DV290
	Center	SB-PC95
	Surround	SB-PS95

For United Kingdom and Republic of Ireland

shop@ **Panasonic**

www.panasonic.co.uk (for UK customers only)

- Order accessory and consumable items for your product with ease and confidence by telephoning our Customer Care Centre Mon-Friday 9:00am-5:30pm. (Excluding public holidays.)
- Or go on line through our Internet Accessory ordering application.
- Most major credit and debit cards accepted.
- All enquiries transactions and distribution facilities are provided directly by Panasonic UK Ltd.
- It couldn't be simpler!

Customer Care Centre
For UK customers: 08705 357357
For Republic of Ireland customers: 01 289 8333

Technical Support
For UK customers: 0870 1 505610

This Technical Support Hot Line number is for Panasonic PC software related products only.

For Republic of Ireland, please use the Customer Care Centre number listed above for all enquiries.

For all other product related enquiries, please use the Customer Care Centre numbers listed above.

Before use

Supplied accessories



Please check and identify the supplied accessories. Use numbers indicated in parentheses when asking for replacement parts.

- AC mains lead** 1
For the United Kingdom (RJA0053-3X) For Australia and N.Z. (RJA0035-2X)

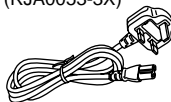

For Continental Europe and Russia (RJA0019-2X)



Note

The included AC mains lead is for use with this unit only. Do not use it with other equipment.

- Remote control** 1
For the United Kingdom, Continental Europe and Russia (EUR7702290) For Australia and N.Z. (EUR7702300)

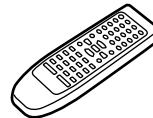
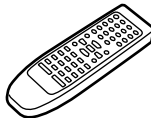

- Remote control batteries** 2



- FM indoor antenna** 1
For the United Kingdom, Continental Europe and Russia (RSA0007) For Australia and N.Z. (RSA0006-J)

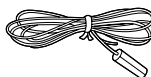

- AM loop antenna set: (RSA0022-L)** 1



- Speaker leads**
(REE1234-1) 2 (Red/Black) (REE1233-1) 2 (Gray/Blue)



- Antenna plug adaptor: (SJP9009)** 1
(Only for the United Kingdom)



- Video cord**
For the United Kingdom and Continental Europe (VJA0815-A) 1
For Russia (RJL1P019B15) 1
For Australia and N.Z. (RJL1P019B15) 2



- RCAJ adaptor: (VFA0151-2)** 1
(Only for the United Kingdom, Continental Europe and Russia)



Before use	
Safety precautions	3
Maintenance	3
Cassette tape selection and care	3
Caution for AC Mains Lead	4
Disc information	5
Simple setup	6
Control guide and preparatory steps	
Front panel controls	10
Turning DEMO off	11
The remote control	12
Setting the time	12
QUICK SETUP	13
Basic operations	
Discs	14
Skip function/Search function/Slow-motion play	15
Frame-by-frame viewing	15
Position Memory function/Selecting groups to play	16
Soundtracks/Subtitles/Cinema	17
Marking places to play again/Variable Zoom function	18
Repeat play/A-B repeat play/All group play	19
Program play	20
Random play/ALL DISC play	21
Starting play from a selected item	21
Playing the programs or play lists on DVD-RAM	22
Navigation menus	22
Using GUI screens	24
The radio: manual tuning	27
The radio: preset tuning	28
Cassette tapes	29
Changing sound field and quality	
Boosting the super woofer	30
Using the super sound equalizer	30
Double re-master—Enjoying more natural sound	30
Changing sound field and quality	30
Using the acoustic image equalizer (AI EQ)	31
Using the manual equalizer (M.EQ)	31
Enjoying surround sound	32
Surround effects	34
Recording operations	
Before recording (Deck 2 only)	35
Recording discs	36
Recording the radio	37
Tape-to-tape recording	37
Timer operations and convenient functions	
Using the timers	38
Changing the sound range display	41
Muting the volume	41
Using headphones (not included)	41
Enjoying karaoke (For Australia and N.Z.)	42
External unit connections	44
Optional antenna connections	45
Using other equipment	45
Changing settings	46
Reference	
Glossary	48
Technical specifications	49
Troubleshooting guide	50

Placement

Set the unit up on an even surface away from direct sunlight, high temperatures, high humidity, and excessive vibration. These conditions can damage the cabinet and other components, thereby shortening the unit's service life.

Do not place heavy items on the unit.

Voltage

Do not use high voltage power sources. This can overload the unit and cause a fire.

Do not use a DC power source. Check the source carefully when setting the unit up on a ship or other place where DC is used.

AC mains lead protection

Ensure the AC mains lead is connected correctly and not damaged. Poor connection and lead damage can cause fire or electric shock. Do not pull, bend, or place heavy items on the lead.

Grasp the plug firmly when unplugging the lead. Pulling the AC mains lead can cause electric shock.

Do not handle the plug with wet hands. This can cause electric shock.

Foreign matter

Do not let metal objects fall inside the unit. This can cause electric shock or malfunction.

Do not let liquids get into the unit. This can cause electric shock or malfunction. If this occurs, immediately disconnect the unit from the power supply and contact your dealer.

Do not spray insecticides onto or into the unit. They contain flammable gases which can ignite if sprayed into the unit.

Service

Do not attempt to repair this unit by yourself. If sound is interrupted, indicators fail to light, smoke appears, or any other problem that is not covered in these instructions occurs, disconnect the AC mains lead and contact your dealer or an authorized service center. Electric shock or damage to the unit can occur if the unit is repaired, disassembled or reconstructed by unqualified persons.

Extend operating life by disconnecting the unit from the power source if it is not to be used for a long time.

Maintenance

If the surfaces are dirty

To clean this unit, wipe with a soft, dry cloth.

- Never use alcohol, paint thinner or benzene to clean this unit.
- Before using chemically treated cloth, read the instructions that came with the cloth carefully.

For a cleaner crisper sound

Clean the heads regularly to assure good quality playback and recording. Use a cleaning tape (not included).

Cassette tape selection and care

The unit can correctly play or record on the following types. It identifies the type automatically.

Normal position/TYPE I	✓
High position/TYPE II	✓
Metal position/TYPE IV	✓

- Tapes exceeding 100 minutes are thin and can break or get caught in the mechanism.
- Tape slack can get caught up in the mechanism and should be taken up before the tape is played.
- Endless tapes can get caught up in the deck's moving parts if used incorrectly. Use tapes appropriate to this unit's auto-reverse mechanism.

(For United Kingdom)

("EB" area code model only)



For your safety, please read the following text carefully.

Before use

This appliance is supplied with a moulded three pin mains plug for your safety and convenience.

A 5-ampere fuse is fitted in this plug.

Should the fuse need to be replaced please ensure that the replacement fuse has a rating of 5-ampere and that it is approved by ASTA or BSI to BS1362.

Check for the ASTA mark  or the BSI mark  on the body of the fuse.

If the plug contains a removable fuse cover you must ensure that it is refitted when the fuse is replaced.

If you lose the fuse cover the plug must not be used until a replacement cover is obtained.

A replacement fuse cover can be purchased from your local dealer.

CAUTION!

IF THE FITTED MOULDED PLUG IS UNSUITABLE FOR THE SOCKET OUTLET IN YOUR HOME THEN THE FUSE SHOULD BE REMOVED AND THE PLUG CUT OFF AND DISPOSED OF SAFELY.

THERE IS A DANGER OF SEVERE ELECTRICAL SHOCK IF THE CUT OFF PLUG IS INSERTED INTO ANY 13-AMPERE SOCKET.

If a new plug is to be fitted please observe the wiring code as stated below.

If in any doubt please consult a qualified electrician.

IMPORTANT

The wires in this mains lead are coloured in accordance with the following code:

Blue: Neutral, Brown: Live.

As these colours may not correspond with the coloured markings identifying the terminals in your plug, proceed as follows:

The wire which is coloured Blue must be connected to the terminal which is marked with the letter N or coloured Black or Blue.

The wire which is coloured Brown must be connected to the terminal which is marked with the letter L or coloured Brown or Red.

WARNING: DO NOT CONNECT EITHER WIRE TO THE EARTH TERMINAL WHICH IS MARKED WITH THE LETTER E, BY THE EARTH SYMBOL \perp OR COLOURED GREEN OR GREEN/YELLOW.

THIS PLUG IS NOT WATERPROOF—KEEP DRY.

Before use

Remove the connector cover.

How to replace the fuse

The location of the fuse differ according to the type of AC mains plug (figures A and B). Confirm the AC mains plug fitted and follow the instructions below.

Illustrations may differ from actual AC mains plug.

1. Open the fuse cover with a screwdriver.

Figure A

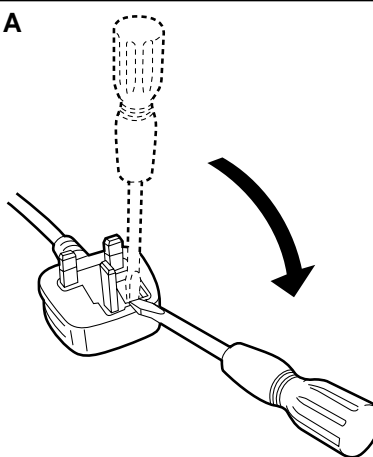
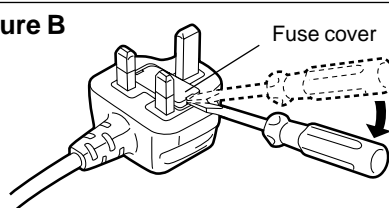

Figure B



2. Replace the fuse and close or attach the fuse cover.

Figure A

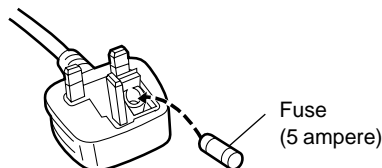
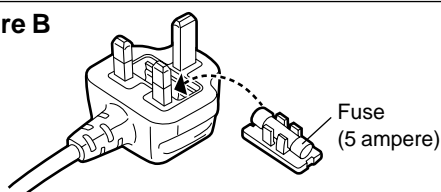









Figure B



DVD-RAM		RAM
DVD-Audio		DVD-A
DVD-Video	 	DVD-V
DVD-R		
Video CD		VCD
CD	 	CD Including CD text
CD-R/RW		WMA MP3 JPEG



Disc information

[A] Discs that can be played

- Use discs with the logos at left and that conform to specifications. The unit cannot play other discs correctly.
- Do not use irregularly shaped discs (e.g. heart-shaped), as these can damage the unit.

■ Discs that cannot be played

DVD-RAM (2.6 GB, TYPE 1), DVD-ROM, CD-ROM, CDV, CD-G, +RW, DVD-RW, CVD, SVCD, SACD, Divx Video Discs and Photo CD.

■ Disc structure

Disc structure and the labels given to the items on discs depend on the disc type.

Track: the smallest division on DVD-Audio, CDs and Video CDs, or a single WMA/MP3 file.

Chapter: the smallest division on DVD-Video.

Group: collections of tracks on DVD-Audio and equivalent to folders or albums on data discs.

Title: the largest division on DVD-Video, usually an entire movie.

Program: the division on DVD-RAM equivalent to a single recording. a single JPEG file.

Play list: a group of scenes on DVD-RAM.

Scene: DVD-RAM program sections specified and grouped into play lists on a DVD video recorder.

Playing DVDs and Video CDs

The producer of these discs can control how they are played so you may not always be able to control play as described in these operating instructions (for example if the play time is not displayed or if a Video CD has menus). Read the disc's instructions carefully.

■ CD-R and CD-RW discs

This unit can play CD-R/RW (audio recording disc) recorded with CD-DA, video CD, WMA, MP3, or JPEG. Finalize the disc after recording.

■ DVD-R discs

Panasonic DVD-R recorded and finalized on a Panasonic DVD video recorder are played as DVD-Video on this unit.

■ DVD-RAM discs

DVD-RAM discs must meet the following conditions for this unit to be able to play them.

Type	<ul style="list-style-type: none"> • Non-cartridge discs • Discs that can be removed from their cartridges (TYPE 2 and 4)
Capacity	<ul style="list-style-type: none"> • 12 cm 9.4 GB (double-sided) and 4.7 GB (single-sided) • 8 cm 2.8 GB (double-sided)
Recording format	Discs recorded with DVD video recorders, DVD video cameras, personal computers, etc., using Version 1.1 of the Video Recording Format (a unified video recording standard).

- Remove TYPE 2 and 4 discs from their cartridges before use, then return them when you are finished. Read the instructions for the disc carefully.
- Do not allow the disc to become dirty or scratched. Store discs in their cartridges and ensure the disc label and cartridge label face the same way.
- Some parts of the disc, for example where one program ends and another begins, may not play smoothly.

Note

It may not be possible to play CD-R, CD-RW, DVD-R and DVD-RAM in all cases due to the type of disc or condition of the recording.

■ Video systems

This unit can play both the PAL and NTSC video systems. To view PAL or NTSC, however, your television must match the system used on the disc. PAL discs cannot be correctly viewed on an NTSC television. NTSC can be correctly viewed on a PAL television by converting the video signal to PAL 60 (→ page 46, Video—NTSC Disc Output).

■ To clean discs

DVD-Audio, DVD-Video, Video CD, CD

Wipe with a damp cloth and then wipe dry. [B]

DVD-RAM, DVD-R

- Clean with an optional DVD-RAM/PD disc cleaner (LF-K200DCA1, where available).

• Never use cloths or cleaners for CDs etc.

■ Handling precautions

- Do not write on the label side with a ball-point pen or other writing instrument.
- Do not use record cleaning sprays, benzine, thinner, static electricity prevention liquids or any other solvent.
- Do not attach labels or stickers to discs. (Do not use discs with exposed adhesive from tape or left over peeled-off stickers.)
- Do not use scratch-proof protectors or covers.
- Do not use discs printed with label printers available on the market.

Simple setup

STEP 1 Locating

Components

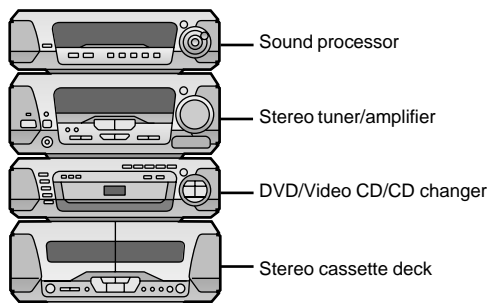
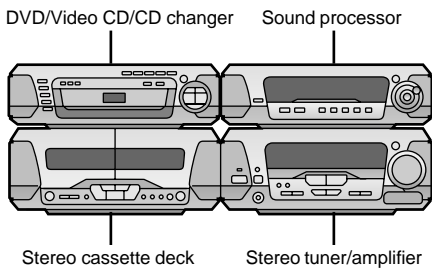

Speakers

Optimum location

Distance: A=B=C=D=E

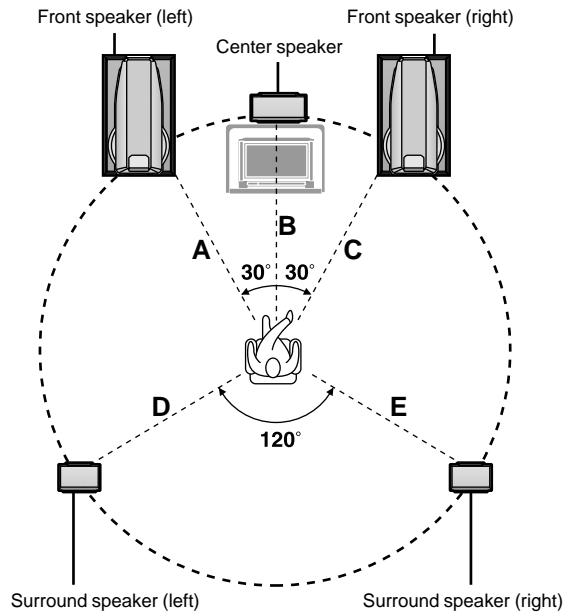

Note

Do not put the DVD/Video CD/CD changer on the top of the tuner/amplifier. Heat can damage your discs.

Use only the supplied speakers.

Using other speakers can damage the unit and sound quality will be negatively affected.

Caution

- Use the speakers only with the recommended system. Failure to do so may lead to damage to the amplifier and/or the speakers, and may result in the risk of fire. Consult a qualified service person if damage has occurred or if you experience a sudden change in performance.
- Do not attempt to attach these speakers to walls using methods other than those described in this manual.

Notes on speaker use

- You can damage your speakers and shorten their useful life if you play sound at high levels over extended periods.
- Reduce the volume in the following cases to avoid damage.
 - When playing distorted sound.
 - When the speakers are receiving howling from a microphone (for Australia and N.Z.) or record player, noise from FM broadcasts, or continuous signals from an oscillator, test disc, or electronic instrument.
 - When adjusting the sound quality.
 - When turning the unit on or off.

If irregular colouring occurs on your television

These speakers are designed to be used close to a television, but the picture may be affected with some televisions and set-up combinations. If this occurs, turn the television off for about 30 minutes. The television's demagnetizing function should correct the problem. If it persists, move the speakers further away from the television.

Front speakers

Left and right front speakers are exactly same.

Surround speakers

Place either side of the listening position, or slightly to the rear, about 1 meter higher than ear level with the Technics logo facing toward the listening position.

The effect varies with the type of music and the music source.

If you are unable to position the surround speakers as recommended, you can put them near the front speakers and still achieve a surround-like effect (➔ page 34, VIRTUAL REAR SURROUND).

Attaching to a wall

Set the speaker onto screws and slide through bracket to lock into position.

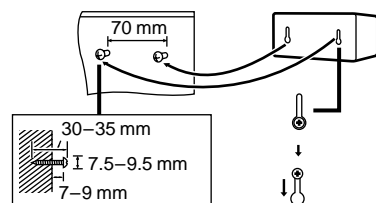

Note

The wall or pillar on which the speakers are to be attached should be capable of supporting 5 kg per screw.

STEP 2 Speaker leads

Do not connect the AC mains lead until all other connections are complete.

Surround and center speakers

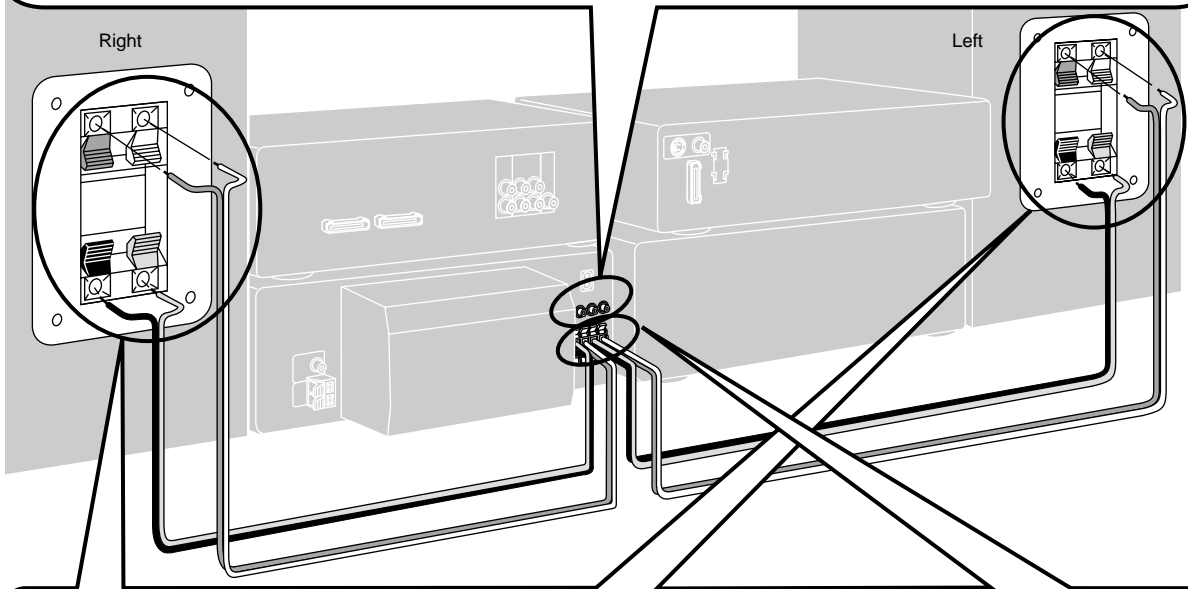
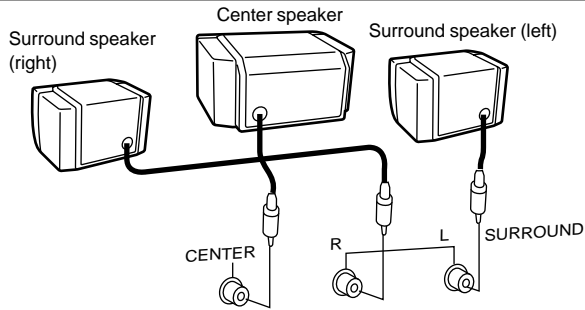

Front speaker

Connect the leads to the terminals of the same colour.

LF and HF stand for low frequency and high frequency.

Connect the left (L) side in the same way.

Note

- Never short-circuit positive (+) and negative (-) speaker wires.
- Be sure to connect only positive (red or grey) wires to positive (+) terminals and negative (black or blue) wires to negative (-) terminals.

Incorrect connection can damage the speakers.

Twist the vinyl tip and pull off.

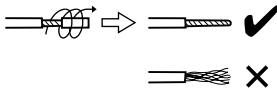

Speaker side

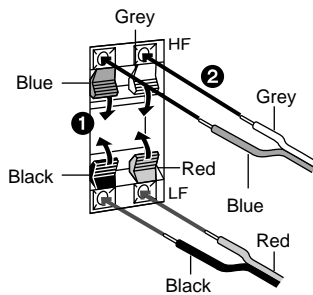

Tuner/amplifier side

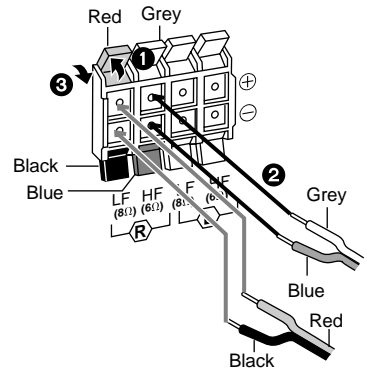

STEP 3 Antennas

FM indoor antenna

Fix the other end of the antenna where reception is best.

Adhesive tape

For Australia and N.Z.

Twist the vinyl tip and pull off.

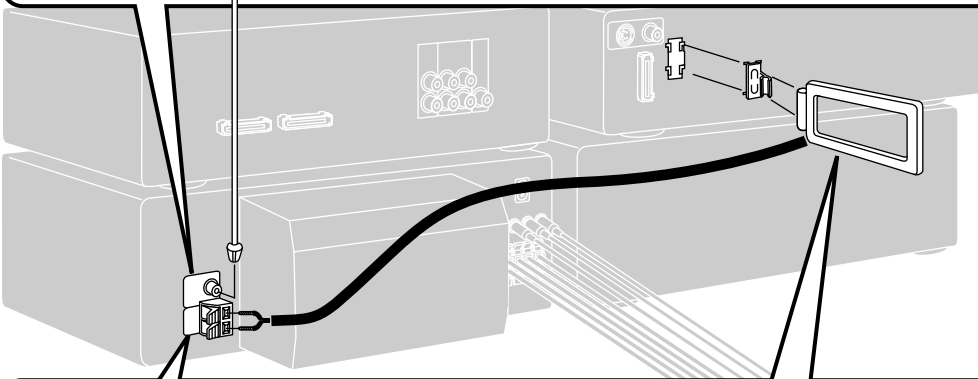

AM indoor antenna

Twist the vinyl tip and pull off.

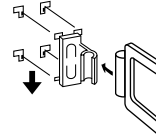
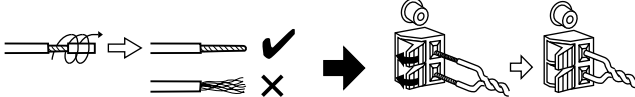

Keep loose antenna cord away from other wires and cords.

STEP 4 Flat cables

Keep the cables as flat as possible against the back of the unit.
Connect the connectors to the terminals of the same colour.
Incorrect connection can damage the unit.

Connecting

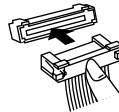

Disconnecting

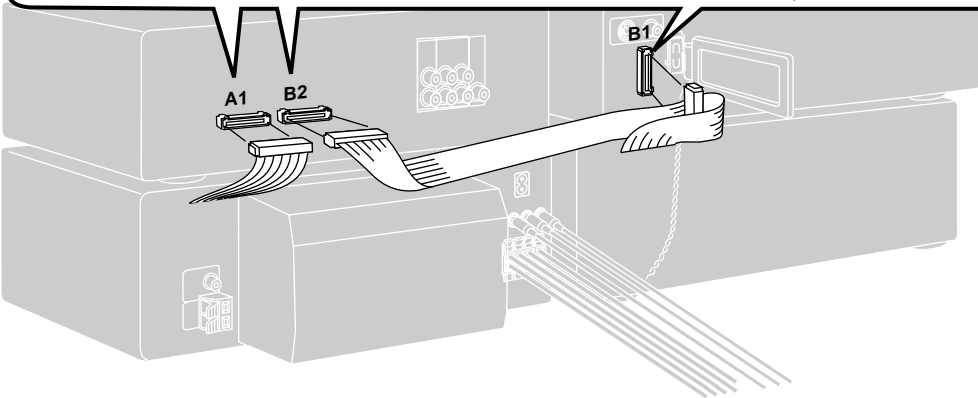
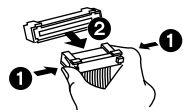

STEP 5 Video cords

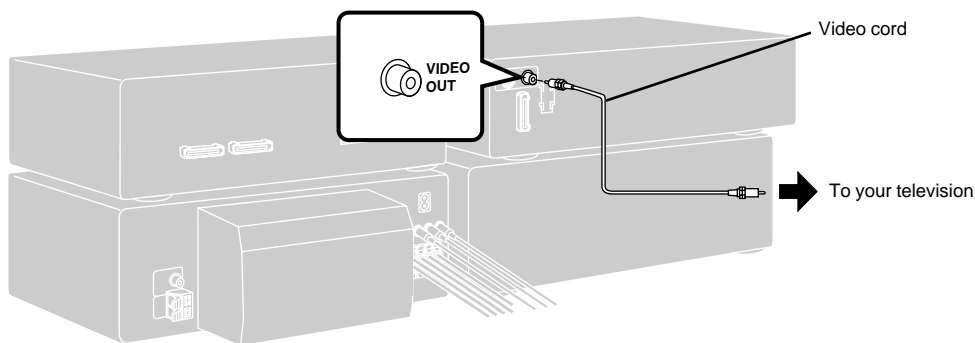

For the United Kingdom, Continental Europe and Russia

Use the RCAJ adaptor (included) if your television has a 21-pin SCART terminal. You do not have to connect anything to the AUDIO terminals.

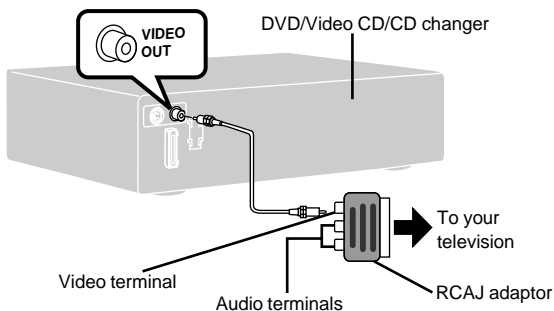

For Australia and N.Z.

Use this connection if you have connected a VCR or Laser Disc player (→ page 44 [B]–[D]). This enables you to control the video and audio from this equipment with [INPUT SELECTOR].

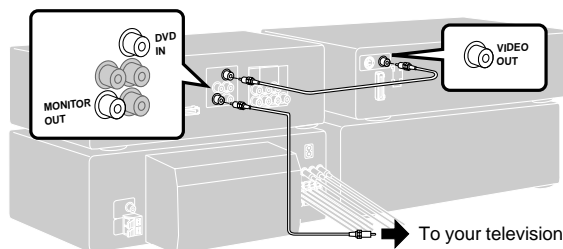

STEP 6 AC mains lead

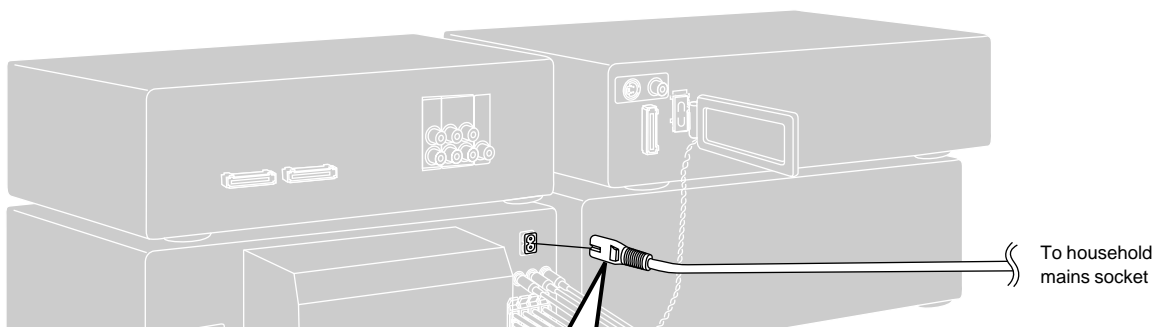

(For the United Kingdom only)
BE SURE TO READ THE CAUTION FOR THE AC MAINS LEAD ON PAGE 4 BEFORE CONNECTION.

Insertion of connector

Even when the connector is perfectly inserted, depending on the type of inlet used, the front part of the connector may jut out as shown in the drawing. However there is no problem using the unit.

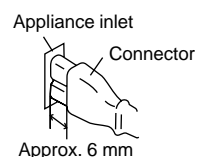

For your reference:

Information you enter into the unit's memory, except for time, remains intact for up to two weeks after the mains lead is disconnected.

Front panel controls

A

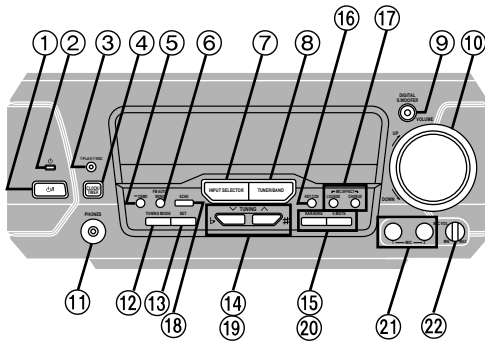

B

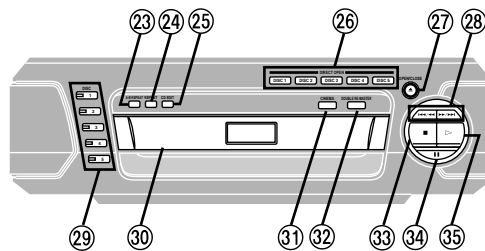

C

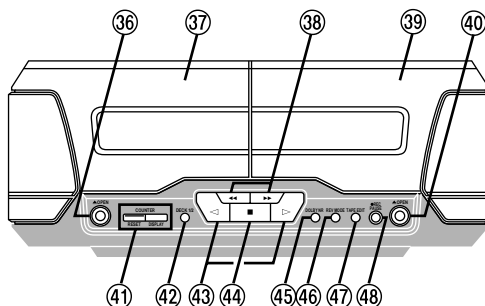

A Stereo tuner/amplifier

- ① **Standby/on switch (⏻/⏻)** 12
Press to switch the unit from on to standby mode or vice versa. In standby mode, the unit is still consuming a small amount of power.
- ② **Standby indicator (⏻)**
When the unit is connected to the AC mains supply, this indicator lights up in standby mode and goes out when the unit is turned on.
- ③ **Play timer/record timer button and indicator (⏻/⏻)** 38, 39
- ④ **Clock/timer button (CLOCK/TIMER)** 12, 38, 39
- ⑤ **Demo button (–DEMO)** 11
- ⑥ **FM mode button (FM AUTO/MONO)** 27
- ⑦ **Source input button (INPUT SELECTOR)** 45
- ⑧ **Tuner/band button (TUNER/BAND)** 27
- ⑨ **Digital super woofer button and indicator (DIGITAL S.WOOFER)** 30
- ⑩ **Volume control (VOLUME)** 14
- ⑪ **Headphone jack (PHONES)** 41
- ⑫ **Tuning mode button (TUNING MODE)** 27
- ⑬ **Set button (SET)** 12, 28
[For the United Kingdom, Continental Europe and Russia]
- ⑭ **Tuning buttons (v, ^ TUNING)** 12, 27
- ⑮ **RDS display mode button (RDS, PS–DISP MODE–PTY)** 27
[For Australia and N.Z.]
- ⑯ **Key control button (KEY CON)** 43
- ⑰ **MIC effect buttons (MIC EFFECT, LOUNGE, CHORUS)** 43
- ⑱ **Echo button (ECHO)** 43
- ⑲ **Tuning, Key up/down buttons (v, ^ TUNING, b, #)** 12, 27, 43
- ⑳ **KARAOKE, Voice mute buttons (KARAOKE, V.MUTE)** 42
- ㉑ **Microphone jacks (1–MIC–2)** 42
- ㉒ **Microphone volume control (MIC VOL)** 42

B DVD/Video CD/CD changer

- ㉓ **A-B repeat button (A-B REPEAT)** 19
- ㉔ **Repeat play button (REPEAT)** 19
- ㉕ **CD edit button (CD EDIT)** 36
- ㉖ **Disc direct open buttons (DIRECT OPEN, DISC 1–DISC 5)** 14
- ㉗ **Disc tray open/close button (▲, OPEN/CLOSE)** 14
- ㉘ **Skip/search buttons (◀◀/◀, ▶/▶▶)** 15
- ㉙ **Disc select buttons and indicators (DISC, 1–5)** 14
Green: Indicates that the tray is ready to play its disc or to be opened.
- ㉚ **Disc tray**
- ㉛ **Cinema mode button and indicator (CINEMA)** 17
- ㉜ **Double re-master button and indicator (DOUBLE RE-MASTER)** 30
- ㉝ **Stop button (■)** 14
- ㉞ **Pause button (||)** 14
- ㉟ **Play button and indicator (▶)** 14
The colour of the indicator depends on the operation taking place.
If stopped: orange
If playing: green
If paused: flashes green
When the resume function is on: flashes orange

C Stereo cassette deck

- ㊱ **Deck 1 cassette holder open button (▲ OPEN)** 29
- ㊲ **Deck 1**
- ㊳ **Fast forward/rewind, TPS buttons (◀◀, ▶▶)** 29
- ㊴ **Deck 2**
- ㊵ **Deck 2 cassette holder open button (▲ OPEN)** 29
- ㊶ **Counter reset, display buttons (COUNTER, RESET, DISPLAY)** 35
- ㊷ **Deck 1/deck 2 selector button (DECK 1/2)** 29
- ㊸ **Playback buttons and indicators (◀, ▶)** 29
The colour of the indicators depends on the operation taking place.
If stopped, fast forwarding or rewinding: orange
If playing or recording: green
While carrying out TPS or recording is on standby: flashes
- ㊹ **Stop button (■)** 29
- ㊺ **Dolby noise reduction button (DOLBY NR)** 29
- ㊻ **Reverse mode button (REV MODE)** 29
- ㊼ **Tape edit button (TAPE EDIT)** 37
- ㊽ **Record pause button (● REC PAUSE)** 36

Front panel controls

A

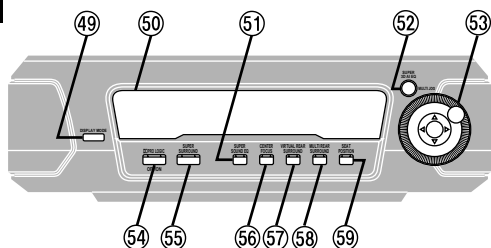

B

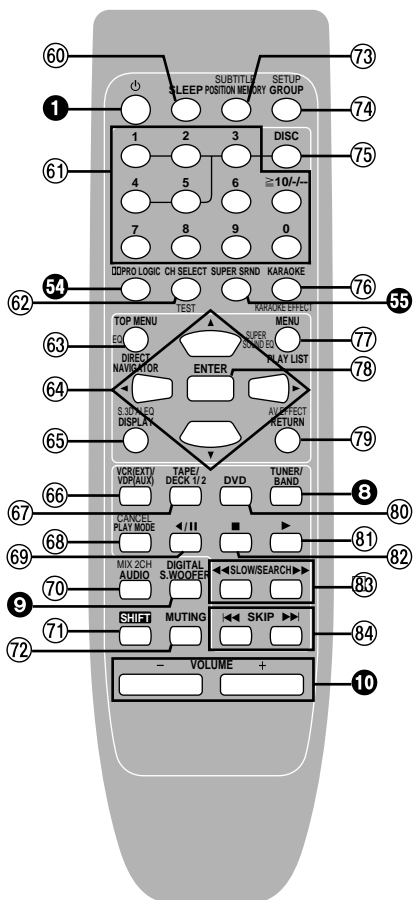

C

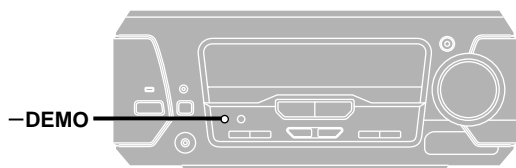
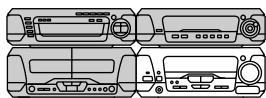

A Sound processor

- 49 Display mode button (DISPLAY MODE) 41
- 50 Display
- 51 Super sound EQ button (SUPER SOUND EQ) 30
- 52 Super 3D AI EQ button (SUPER 3D AI EQ) 31
- 53 Jog control and joystick (◀, ▶, ▲, ▼, MULTI JOG) 30
- 54 DOLBY PRO LOGIC button and indicator (DOLBY PRO LOGIC, OFF/ON) 33
- 55 Super surround button and indicator (SUPER SURROUND) 33
- 56 Center focus button and indicator (CENTER FOCUS) 34
- 57 Virtual rear surround button and indicator (VIRTUAL REAR SURROUND) 34
- 58 Multi rear surround button and indicator (MULTI REAR SURROUND) 34
- 59 Seat position button and indicator (SEAT POSITION) 34

B Remote control

Buttons 1, 3, 9, 10, 53 and 55 function in the same way as the controls on the main unit.

- 60 Sleep timer button (SLEEP) 40
 - 61 Numbered buttons (1-9, 0, ≥ 10 /-/-) 14
 - 62 Channel select, Test signal button (CH SELECT, TEST) 33
 - 63 Top menu, Direct navigator, EQ button (TOP MENU, DIRECT NAVIGATOR, EQ) 14, 22, 30
 - 64 Cursor buttons (◀, ▶, ▲, ▼) 13, 47
 - 65 Display, Super 3D AI EQ button (DISPLAY, S.3D AI EQ) ... 18, 31
 - 66 Input select button [VCR (EXT)/VDP (AUX)] 45
 - 67 Tape select, deck 1/deck 2 select button (TAPE/DECK 1/2) 29
 - 68 Play mode, Cancel button (PLAY MODE, CANCEL) 18, 19
 - 69 Disc pause, Tape reverse play button (◀/II) 14, 29
 - 70 Audio select, 2 channel down mixing button (AUDIO, MIX 2CH) 17, 33
 - 71 Shift button (SHIFT) 13
- To operate functions labeled in orange, press [SHIFT] and then the corresponding button at the same time.
- 72 Muting button (MUTING) 41
 - 73 Position memory, Subtitle select button (POSITION MEMORY, SUBTITLE) 16, 17
 - 74 Group, Initial setting button (GROUP, SETUP) 13, 16, 47
 - 75 Disc button (DISC) 20
 - 76 [For Australia and N.Z.] Karaoke, Karaoke effect button (KARAOKE, KARAOKE EFFECT) 42, 43
 - 77 Menu, Play list, Super sound EQ button (MENU, PLAY LIST, SUPER SOUND EQ) 14, 22, 30
 - 78 Enter button (ENTER) 13, 47
 - 79 Return, AV effect button (RETURN, AV EFFECT) 13, 34
 - 80 DVD button (DVD) 13
 - 81 Disc play, Tape forward play button (▶) 14, 29
 - 82 Disc stop, Tape stop button (■) 14, 29
 - 83 Disc slow/search buttons (◀◀, ▶▶ SLOW/SEARCH) 15
 - 84 Disc skip buttons (◀◀◀, ▶▶▶ SKIP) 15

[C] Turning DEMO off

A demonstration of the display is shown if you have not set the clock.

You can reduce the power consumed in standby mode by turning the demonstration off.

While the unit is on:

Press and hold [-DEMO] until "NO DEMO" is displayed.

Each time you press and hold the button:
NO DEMO (off) ⇄ DEMO (on)

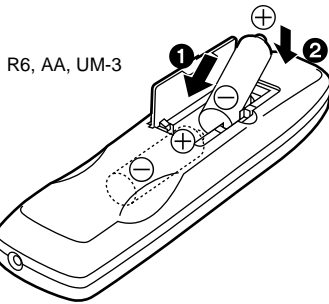
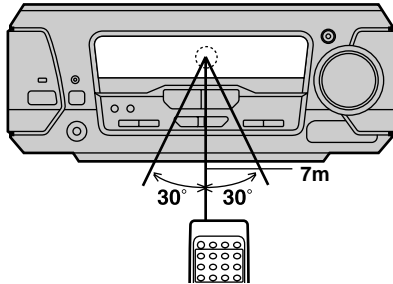
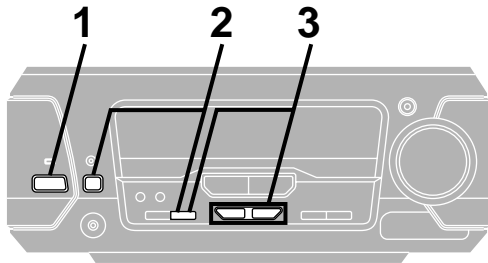
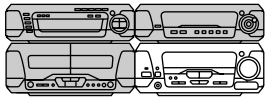
A**B****C****1****2****3**

The remote control

A Batteries

- Insert so the poles (+ and -) match those in the remote control.
- Do not use rechargeable type batteries.

Do not;

- mix old and new batteries.
- use different types at the same time.
- heat or expose to flame.
- take apart or short circuit.
- attempt to recharge alkaline or manganese batteries.
- use batteries if the covering has been peeled off.
- keep together with metallic objects such as necklaces.

Mishandling of batteries can cause electrolyte leakage which can damage items the fluid contacts and may cause a fire.

If electrolyte leaks from the batteries, consult your dealer.

Wash thoroughly with water if electrolyte comes in contact with any part of your body.

Remove if the remote control is not going to be used for a long period of time. Store in a cool, dark place.

Replace if the unit does not respond to the remote control even when held close to the front panel.

B Use

Aim at the sensor, avoiding obstacles, at a maximum range of about 7 meters directly in front of the unit.

- Keep the transmission window and the unit's sensor free from dust.
- Operation can be affected by strong light sources, such as direct sunlight, and the glass doors on cabinets.

Do not;

- put heavy objects on the remote control.
- take the remote control apart.
- spill liquids onto the remote control.

C Setting the time

This is a 24-hour clock.

The example shows how to set the clock for 16:25 (4:25 p.m.).

1 Press **[P/|]** to turn the unit on.

2 **①** Press **[CLOCK/TIMER]** to display "CLOCK".

Each time you press the button:
CLOCK → **[PLAY]** → **[REC]** → Original display

② Within 5 seconds
Press **[SET]**.

3 **①** Press **[TUNING (∨ or ^)]** to set the time.

The time display can be changed in one minute units by tapping the buttons, and quickly by holding down the buttons.

② Press **[SET]**.

The time is set and the original display is restored.

Displaying the clock

Press **[CLOCK/TIMER]**.

The clock is shown for about 5 seconds.

Reset the clock regularly to maintain accuracy.

QUICK SETUP

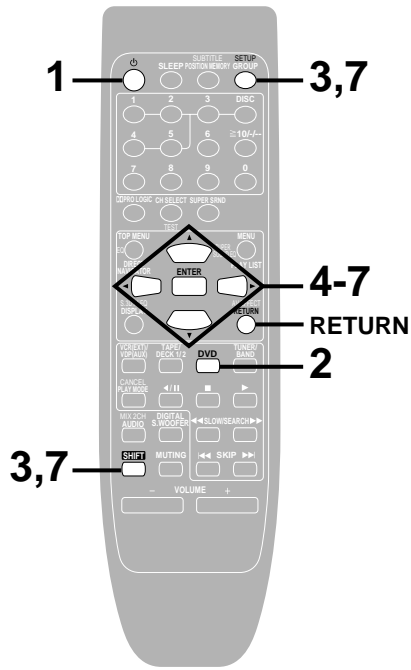

The QUICK SETUP screen appears when you press [SHIFT]+[SETUP] the first time after purchase and assists you to make necessary settings. You can access this screen again later if you need to (⇒ page 46, Others—QUICK SETUP)

Remote control only

Preparation

Turn on the television and select the appropriate video input on the television to suit the connections for the unit.

- 1** Press [POWER] to turn on the unit.
- 2** Press [DVD] to select “DVD”.
- 3** Press [SHIFT]+[SETUP] to show the QUICK SETUP screen. [A]
- 4** Press [▲, ▼, ◀, ▶] to select the menu language and press [ENTER].
- 5** Press [▲, ▼] to select “Yes” to continue and press [ENTER].
- 6** Press [▲, ▼, ◀, ▶] to select the item and press [ENTER].
 - Audio Language (⇒ page 46)
 - Subtitle Language (⇒ page 46)
 - TV Type (⇒ below)
 - TV Aspect (⇒ below)
- 7** Press [ENTER] and then [SHIFT]+[SETUP] to end the settings.

A

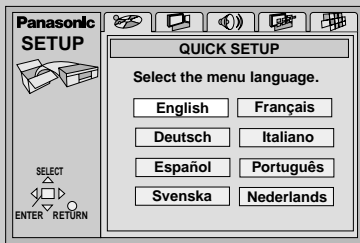

B



C



To return to the previous screen

Press [RETURN].

■ TV Type

Select to suit the type of television.

- Standard (Direct View TV) (factory preset)
- CRT Projector
- LCD TV/Projector
- Projection TV
- Plasma TV

■ TV Aspect

Select “4:3” (regular) or “16:9” (widescreen) to suit your television.

If you have a regular 4:3 television, you can also select how video on some discs is shown (⇒ page 46, Video—TV Aspect).

[B] 4:3 Pan&Scan (factory preset)

Widescreen software is expanded to fill the screen of a 4:3 aspect television (unless prohibited by the producer of the disc).

[C] 4:3 Letterbox

Widescreen software is shown in the letterbox style on a 4:3 aspect television.

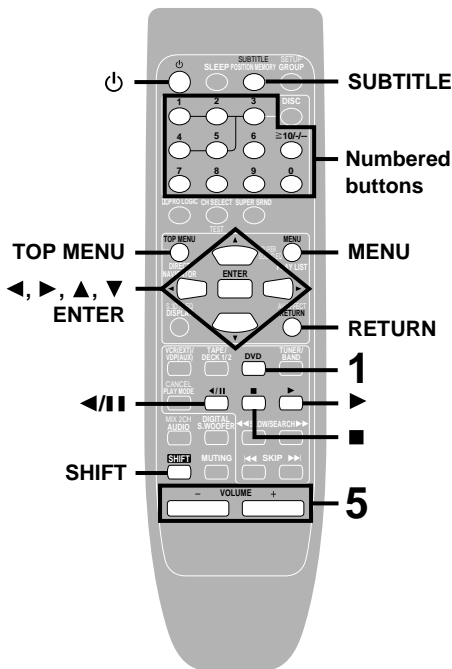
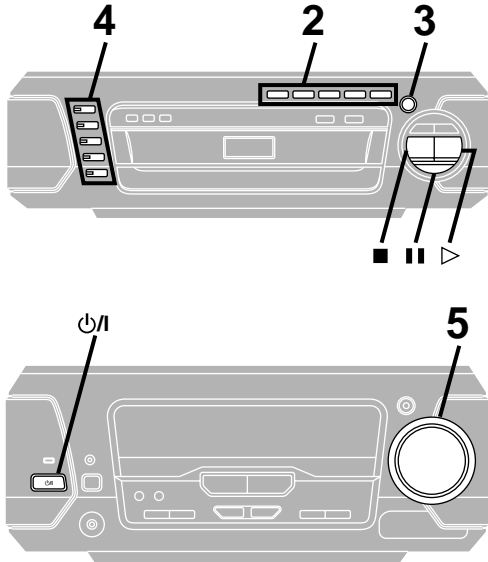
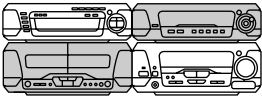

A



B



Discs

[RAM] [DVD-A] [DVD-V] [VCD] [CD] [WMA] [MP3] [JPEG]

Preparation

- Press [⏻/I] to turn on the unit.
- Turn on the television and select the appropriate video input on the television to suit the connections for the unit.

- 1 Press [DVD] to select “DVD” as the source.**
 If the disc contains both audio data (WMA and MP3) and JPEG, check “Mixed Disc—Audio & Stills” setting in the SETUP menu (→ page 46). Select “Audio (MP3/WMA)” or “Stills (JPEG)”.
- 2 Press DIRECT OPEN [DISC 1]–[DISC 5] to open a tray and set a disc.**
 - [RAM] Remove TYPE 2 and 4 discs from their cartridges before use. [A]
 - Label-up (With double-sided discs, load so the label for the side you want to play is facing up.) [B]
- 3 Press [▲, OPEN/CLOSE] to close the tray.**
 The tray closed is in the play position (its disc indicator turns green). Some discs start playing automatically. Repeat steps 2 and 3 to load the other trays.
- 4 Press [DISC, 1–5] to change the play position tray and start play.**
 [CD] (CD text only) [WMA] [MP3]
 Track information appears on the television. Press [SHIFT]+[SUBTITLE] to turn the display on or off.
- 5 Adjust the volume.**

Play position

The disc in the play position is ready to play immediately when you press [▶].

To pause play

Press [⏸] during play.
 Press [▶] to restart play.

To stop play

Press [■].
 “RESUME” lights on the display when the unit has recorded the position at which you stopped play.
 Press [▶] to start play from that position.
 [DVD-V]: Press [▶] again to review chapters (→ page 16).
 • Press [■] to clear the position.
 • The position is cleared when you turn the unit off, change the source, open the disc tray or change the disc.

Note

- If “⊙” appears on the television
 The operation is prohibited by the unit or disc.
- It may take some time for play to start but this is normal.

When a menu appears on the television

[DVD-A] [DVD-V] [VCD]

Remote control only

Press the numbered buttons to select an item.

To select a 2-digit number

Example: To select item 23, press [≥10/--] → [2] → [3].
 • When playing DVDs, you can also use [▲, ▼, ◀, ▶] to select items.
 Press [ENTER] to confirm your selection.

To return to the menu screen

[DVD-A] [DVD-V] [TOP MENU]: Shows the first menu screen.
 [DVD-V] [MENU]: Shows the menu screen.
 [VCD] [RETURN]: Shows the menu screen.

Note

The disc continues to rotate while the menu is displayed even after you finish playing an item. Press [■] when you finish to preserve the unit's motor and your television screen.

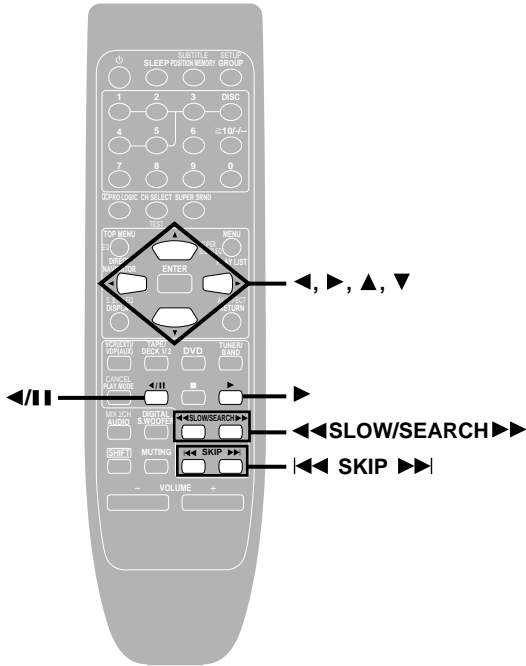
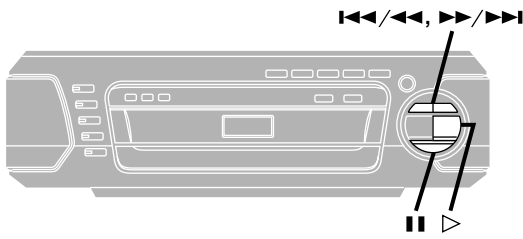
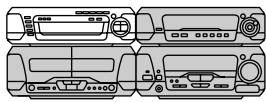

Discs

Skip function

[RAM] [DVD-A] [DVD-V] [VCD] [CD] [WMA] [MP3] [JPEG]

While playing or paused

On the remote control

Press [SKIP (|◀◀ or ▶▶)].

On the changer

Press [◀◀/◀◀] or [▶▶/▶▶].

[JPEG]

Remote control only

Press [▲] or [▼] for group skip.

Each press increases the number of skips.

Search function

[RAM] [DVD-A] [DVD-V] [VCD] [CD] [WMA] [MP3]

During play

On the remote control

Press [SLOW/SEARCH (◀◀ or ▶▶)].

On the changer

Press and hold [◀◀/◀◀] or [▶▶/▶▶].

- Audio will be heard during search for most discs. You can turn this audio off if you want to (→ page 46, Audio—Audio during Search).
- [DVD-V] You can slow down or speed up play (→ page 24).

Slow-motion play

[RAM] [DVD-V] [VCD]

[DVD-A] (Motion picture parts only)

While play is paused

On the remote control

Press [SLOW/SEARCH (◀◀ or ▶▶)].

On the changer

Press and hold [◀◀/◀◀] or [▶▶/▶▶].

Frame-by-frame viewing

[RAM] [DVD-V] [VCD]

[DVD-A] (Motion picture parts only)

Remote control only

While play is paused

Press [◀] or [▶].

- Each press changes the frame.
- The frames change in succession if you press and hold a cursor button.
- The frame also advances each time you press [◀/▶] on the remote control or [||] on the changer.

Notes

- The speed of search and slow-motion increases up to 5 steps.
- Press [▶] (play) to restart play.
- You cannot move backwards with Video CD during frame-by-frame and slow-motion.

When playing Video CDs with playback control

Pressing buttons to perform skip, search or slow-motion may take you to a menu screen.

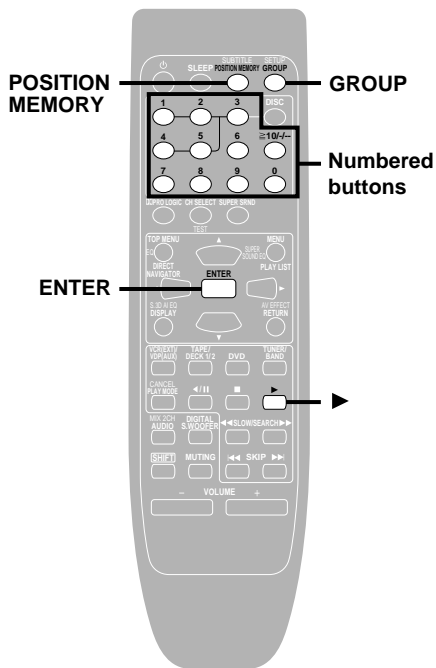

Remote control only

A Position Memory function

[RAM] [DVD-A] [DVD-V] [VCD] [CD] [WMA] [MP3] [JPEG]

During play

Press [POSITION MEMORY] to memorize a position.

Press again to replace the position.

This position is saved even if you turn the unit off, change the source, open the disc tray or change the disc. When you turn the unit on, reselect "DVD" or reinsert the disc whose position you memorized, "RESUME" lights on the display. Press [▶] (play) to start play from the memorized position. The position is cleared.

- You can memorize positions on up to five different discs at a time. When you memorize another position, the earliest position is replaced.
- This function does not work while playing some DVDs or play lists on DVD-RAM.

Chapter Review

[DVD-V]

This message appears. [B]

Press [▶] (play) again to review the first few seconds of the chapters up to the one where you memorized the position. Play then resumes from the memorized position.

Do not press [▶] (play) if you do not want to review chapters.

Selecting groups to play

[DVD-A] [WMA] [MP3] [JPEG]

- 1 Press [GROUP]. [C]
- 2 Press the numbered buttons to select the group number and press [ENTER].
- 3 Press the numbered buttons to select the track/picture number and press [ENTER].

[DVD-A]

Playing all the groups in succession (→ page 19, All group play)

Playing bonus groups

Some discs contain bonus groups. If a password screen appears after selecting a group, enter the password with the numbered buttons. Refer to the disc's jacket.

A



B

Press PLAY to Chapter Review

C

Example [MP3]



Track number in group
Group number

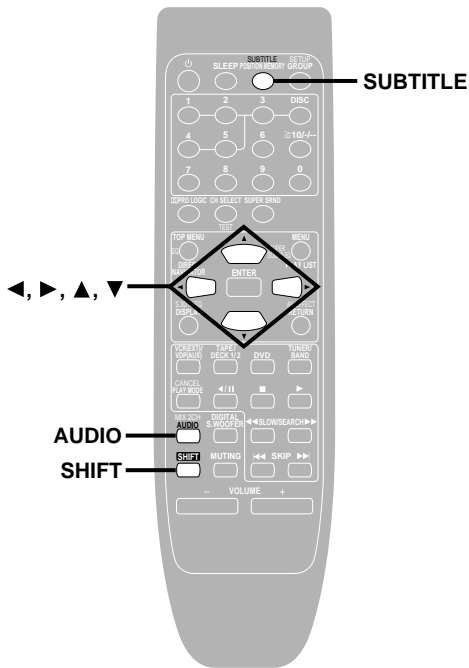

A

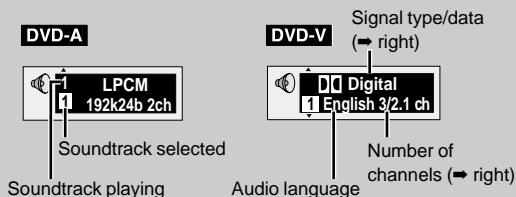

RAM

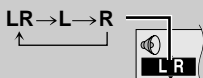

B

Example [DVD-V]

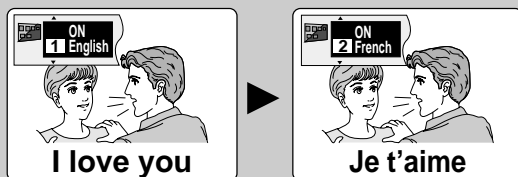

C

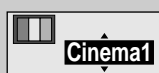
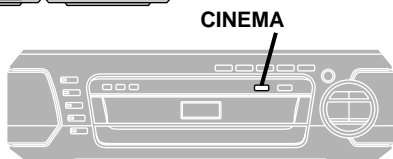
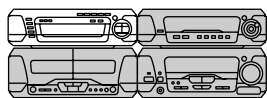

A Soundtracks

[RAM] [DVD-A] [DVD-V]

(Discs with multiple soundtracks)

Remote control only

During play

Press [AUDIO].

The number on the television changes each time you press the button.

- "—" or "—" is displayed instead of the language number in circumstances such as when no language is recorded on the disc.

- You can also use this button to turn the vocals on and off on karaoke discs. Read the disc's instructions for details.

[DVD-A]

- Play restarts from the beginning of the soundtrack when changing soundtracks that are accompanied by still pictures.

- Even if a second soundtrack isn't recorded, two soundtrack numbers will normally appear in the soundtrack display. The soundtrack currently playing is number 1.

Signal type/data

LPCM/PPCM/Digital/DTS/MPEG: Signal type

k (kHz): Sampling frequency

b (bit): Number of bits ch (channel): Number of channels

Example:

3/2 .1ch

1: Low frequency effect (not displayed if there is no signal)
--

0: No surround

1: Mono surround

2: Stereo surround (left/right)

1: Center

2: Front left + Front right

3: Front left + Front right + Center

B Subtitles

[DVD-A] (Motion picture parts only) [DVD-V]

(Discs with multiple subtitle languages)

You can change the subtitle language and turn the subtitles on and off.

[RAM]

You can turn the subtitles on and off.

Remote control only

During play

Press [SHIFT]+[SUBTITLE].

The number on the television changes each time you press the button.

- "—" or "—" is displayed instead of the language number in circumstances such as when no language is recorded on the disc.

- In some cases, the subtitle language is not changed to the selected one immediately.

To clear/display the subtitles

1. Press [SHIFT]+[SUBTITLE].
2. Press [▶]. ([DVD-A] [DVD-V])
3. Press [▲, ▼] to display "OFF" or "ON" on the television.

Changing the position and brightness of the subtitles (→ page 26)

C Cinema

[RAM] [DVD-A] [DVD-V] [VCD] [JPEG]

Change the picture quality for movie viewing.

Press [CINEMA].

CINEMA indicator lights up.

Each time you press the buttons:

- **Cinema1:** Mellows images and enhances detail in dark scenes.

- **Cinema2:** Sharpens images and enhances detail in dark scenes.

- **Normal:** Normal mode (factory preset)

- Use the Picture menu (→ page 26) to make finer adjustments.

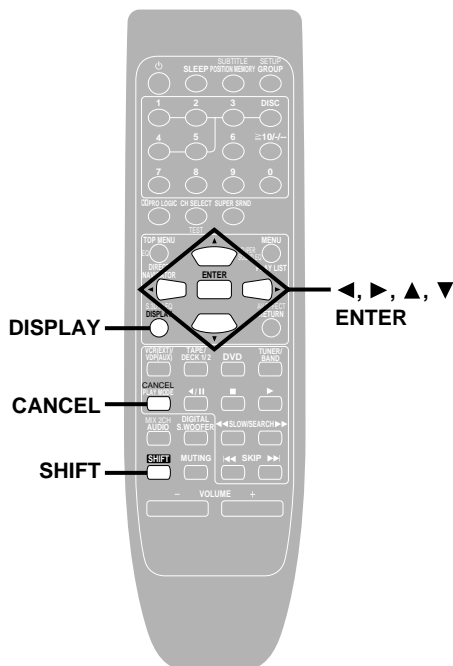

Remote control only

Marking places to play again

[RAM] [DVD-A] [DVD-V] [VCD] [CD] [WMA] [MP3] [JPEG]

You can mark a position so you can return to it easily at a later time.

- 1 During play
Press [DISPLAY] until the unit information screen is displayed (⇒ page 26).
- 2 Press [▲, ▼] to select the play menu. [A]
- 3 Press [◀, ▶] to select “Marker” and press [ENTER].
[RAM]
- 4 Press [▶] to select an asterisk (*).
Press [ENTER] at the point you want to mark.

To mark another position

Up to 5 points ([RAM] only: up to 999 points)

- 1 Press [▶] to select “*”.
- 2 Press [ENTER] at the point.

To recall or erase a marker

- 1 Press [◀, ▶] to select a marker.
- 2 Press [ENTER] to recall or press [SHIFT]+[CANCEL] to erase.

[RAM]

To mark the eleventh point and beyond

- 1 Press [◀, ▶] to select the marker pin icon. [B]
- 2 Press [▲, ▼] to select “11-20”.

You can select the next group when the current group is full.

Note

Markers added with this unit clear when you turn the unit off, change the source, open the disc tray or change the disc.

Variable Zoom funcion

[RAM] [DVD-V] [VCD]

[DVD-A] (Motion picture parts only)

Change the zoom ratio so the picture expands to the optimum size to fill the screen.

Preparation

Change the setting “TV Aspect” to suit your television (⇒ page 46).

- 1 During play
Press [DISPLAY] until the unit information screen is displayed (⇒ page 26).
- 2 Press [▲, ▼] to select the display menu. [C]
- 3 Press [◀, ▶] to select “Zoom” and press [ENTER].
- 4 Press [◀, ▶] to select the aspect ratio.
4:3 Standard ↔ European Vista ↔ 16:9 Standard
↕
Cinemascope2 ↔ Cinemascope1 ↔ American Vista
•Refer to the disc’s instructions and “Screen size” below for the aspect ratio of the picture.
- 5 Press [▲, ▼] to make fine adjustment and press [ENTER].
The ratio changes in 0.01 units between 1.00 and 1.60 and in 0.02 units between 1.60 and 2.00.

To restore the original ratio

Press [◀, ▶] until the ratio returns to 1.00.

- The ratio also returns to 1.00 when you turn the unit off, change the source, open the disc tray or change the disc.
- The ratio may return to 1.00 when a menu is displayed.

[D] Screen size

Movies are made using a variety of screen sizes.

A Example [DVD-V]



Marker

B

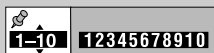

C Example [DVD-V]



Zoom

D

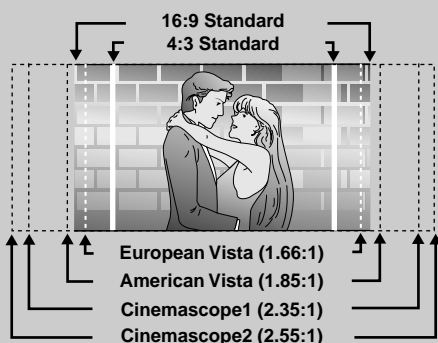

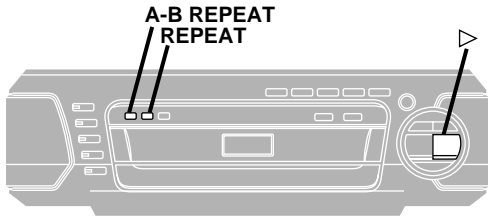
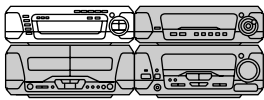

A



B

1



2



C

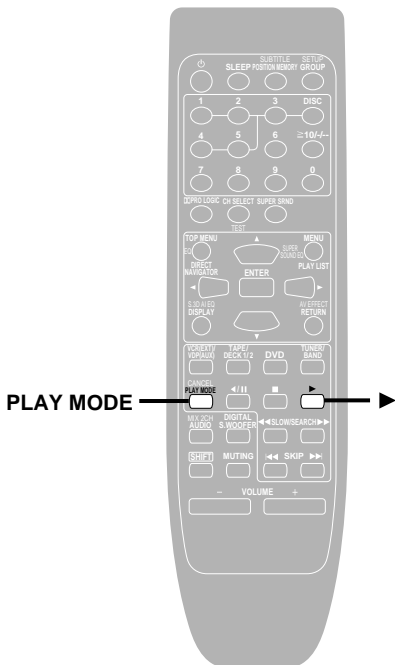

1



Discs

A Repeat play

[RAM] [DVD-A] [DVD-V] [VCD] [CD] [WMA] [MP3] [JPEG]

During play

Press [REPEAT].

Each time you press the button:

[RAM]

Program → All (Entire disc) → Off

• During play list play

Scene → Playlist → Off

[DVD-V]

Chapter → Title → Off

[DVD-A]

[WMA] [MP3] (There is no on-screen display.)

Track → Group* → Off

*During all group play, "All" is displayed. [DVD-A]

[JPEG]

Group → Off

[VCD] [CD] (There is no on-screen display.)

Entire disc → Off

Use the PLAY MODE function if you want to listen to all discs repeatedly (→ page 21, ALL DISC play). [VCD] [CD]

To repeat only your favorite tracks [VCD] [CD]

① Program the tracks you want (→ page 20).

② Press [▷]. Play will start.

③ Press [REPEAT] to display "↻".

B A-B repeat play

[RAM] [DVD-A] [DVD-V] [VCD] [CD] [WMA] [MP3]

1 During play

Press [A-B REPEAT] at the starting point (A).

2 Press [A-B REPEAT] at the finishing point (B).

To cancel A-B repeat play

Press [A-B REPEAT] to clear "↻" on the tuner/amplifier.

C All group play

[DVD-A]

Remote control only

Preparation:

Ensure a DVD-Audio is in the play position tray.

1 While stopped

Press [PLAY MODE] to display "ALL GROUP" on the tuner/amplifier.

Each time you press the button:

ALL GROUP ↔ (off)

2 Press [▶] (play).

Note

If you select bonus groups, you will have to enter a password (→ page 16).

Program play

[VCD] [CD]

Remote control only

You can select up to 24 tracks on any of the loaded Video CDs or CDs to play in the order you choose.

Preparation:

Ensure a Video CD or CD is in the play position tray. (Program play is not possible if the play position tray is empty or contains a disc other than a Video CD or CD.)

- 1 While stopped
Press [PLAY MODE] to display "PRGM" on the tuner/amplifier.

Each time you press the button:

ALL DISC → PRGM → RANDOM → (off)

- 2 Press [DISC] and (within 10 seconds) [1]–[5] to select the disc.

- 3 Select the track with the numbered buttons.

For tracks numbered 10 and over, press [≥10/--] then the two digits. The tuner/amplifier shows the disc number, track number and programmed order.

Repeat steps 2 and 3 to program the tracks in the required order.

- 4 Press [▶] (play).

To exit program mode

Press [PLAY MODE] while in the stop mode to clear "PRGM" on the tuner/amplifier.

Program contents will be saved in the memory.

You can do the following while the disc is stopped in program mode

Press [■] to cancel the resume function (⇒ page 14) if it is on.

•Checking program contents

Each time you press [SKIP] ([◀◀] or [▶▶]), the disc number, track number and program order are displayed.

•Adding to the program

Repeat steps 2 and 3.

•Canceling a particular track

Select the track with [SKIP] ([◀◀] or [▶▶]) then press [SHIFT]+[CANCEL].

•Canceling all tracks

Hold [■] for 3 seconds.

If "FULL" is displayed

24 tracks have been programmed. No further tracks can be programmed.

Note

•Discs and tracks the unit cannot find can be programmed but are skipped during play. This is also the case if you program a disc other than a Video CD or CD.

•Skipping is done in the programmed order.

•You can search only within a track being played.

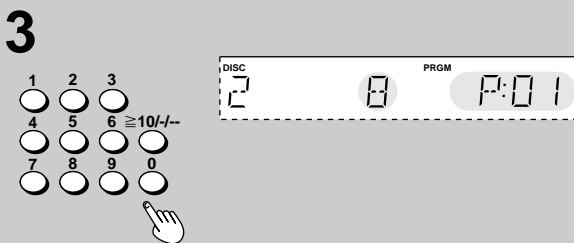
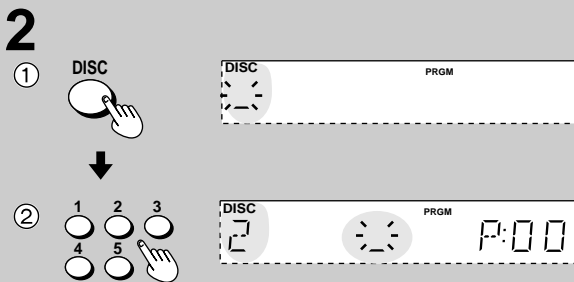
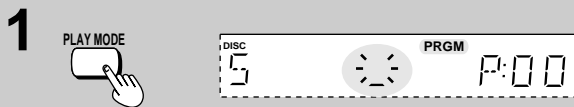
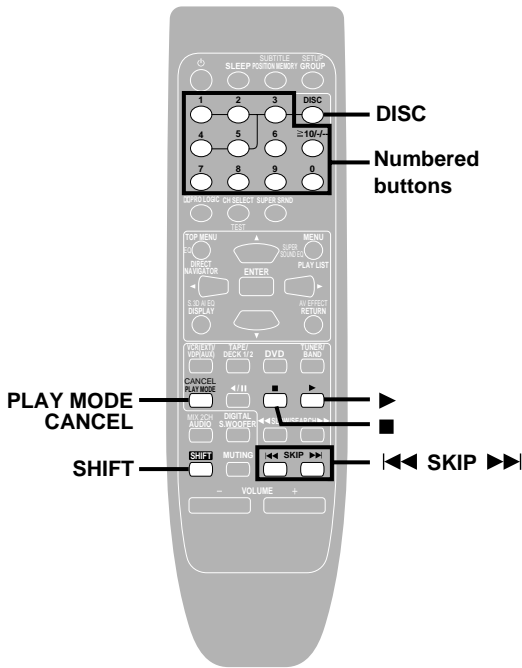

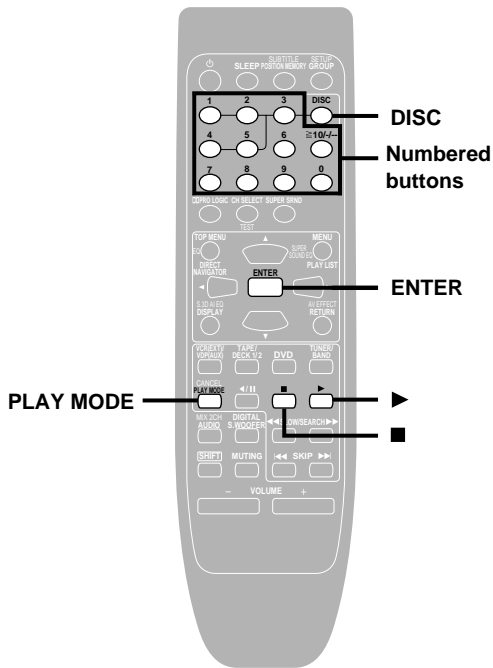

A

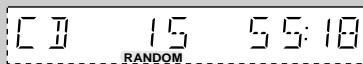

B

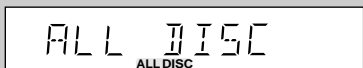

Discs

Remote control only

Random play

[VCD] [CD]

Plays all discs once each in random order.

Ensure a Video CD or CD is in the play position tray. (Random play is not possible if the play position tray is empty or contains a disc other than a Video CD or CD.)

1

While stopped

Press [PLAY MODE] to display "RANDOM" on the tuner/amplifier. [A]

Each time you press the button:

ALL DISC → PRGM → RANDOM → (off)

2

Press [▶] (play) .

To exit random mode

Press [PLAY MODE] while in the stop mode to clear "RANDOM" on the tuner/amplifier.

Note

- If the disc is a Video CD with PBC, menu play is automatically canceled during random play.
- This function skips discs other than a Video CD or CD.
- You cannot skip to tracks already played.
- You can search only within a track being played in random play.

ALL DISC play

[VCD] [CD]

You can play up to 5 discs in succession to the final disc.

Ensure a Video CD or CD is in the play position tray. (ALL DISC play is not possible if the play position tray is empty or contains a disc other than a Video CD or CD.)

1

While stopped

Press [PLAY MODE] to display "ALL DISC" on the tuner/amplifier. [B]

Each time you press the button:

ALL DISC → PRGM → RANDOM → (off)

2

Press [▶] (play) .

To cancel

Press [PLAY MODE] while in the stop mode to clear "ALL DISC" on the tuner/amplifier.

Final disc

For example, if play starts from disc 4, disc 3 will be the final disc.

Order of progression: Disc 4 → 5 → 1 → 2 → 3

Starting play from a selected item

[RAM] [DVD-A] [DVD-V] [VCD] [CD] [WMA] [MP3] [JPEG]

1 Press [DISC] and (within 10 seconds) [1]–[5] to select the disc.

Play starts from the first item.

- If a menu appears (Video CD with PBC), press [■] to cancel menu play.

2

Press the numbered buttons to select the item.

Play starts from the selected item.

To select a 2-digit number

Example: To select track 23, press [≧10/-/-] → [2] → [3].

[WMA] [MP3] [JPEG]: [2] → [3] → [ENTER]

Note

This works only when stopped with some discs.

Playing the programs or play lists on DVD-RAM

[RAM]

Remote control only

Selecting a program to play—DIRECT NAVIGATOR

Use the program list to find programs to play.

- 1 Press [DIRECT NAVIGATOR]. [A]
- 2 Press [▲, ▼] to select the program.
The selected program plays in the background.
 - You can select programs with the numbered buttons.
 - To select a 2-digit number
Example 23: [≧10/-/-] → [2] → [3].
- 3 Press [ENTER].
The program being played in the background continues.

To clear the program list

Press [DIRECT NAVIGATOR].

Note

- Titles appear only if you have entered them.
- You cannot change program and disc titles.

Using the play list menu

You can play a group of scenes, a play list, created on other equipment such as a DVD video recorder.

- 1 Press [PLAY LIST]. [B]
- 2 Press [▲, ▼] to select the play list.
 - You can select play lists with the numbered buttons.
 - To select a 2-digit number
Example 23: [≧10/-/-] → [2] → [3]
- 3 Press [ENTER] to start play.

To clear the play list screen

Press [PLAY LIST].

Navigation menus

If the disc contains both audio data (WMA and MP3) and JPEG, check "Mixed Disc—Audio & Stills" setting in the SETUP menu (→ page 46). Select "Audio (MP3/WMA)" or "Stills (JPEG)".

[WMA] [MP3] [CD] (CD text only) [JPEG]

Remote control only

These menus help you find items to play.

- 1 Press [TOP MENU].
[C] [WMA] [MP3] Audio navigation menu
"☞" indicates the track currently playing.
[D] [JPEG] Album display
- 2 Press [▲, ▼] to select a track or [▲, ▼, ◀, ▶] to select the picture, and press [ENTER].
To show other pages, press [▲, ▼, ◀, ▶] to select "Prev" or "Next" and press [ENTER].
 - After listing all the tracks or pictures in one group, the list for the next group appears.

To exit the menu

Press [TOP MENU].

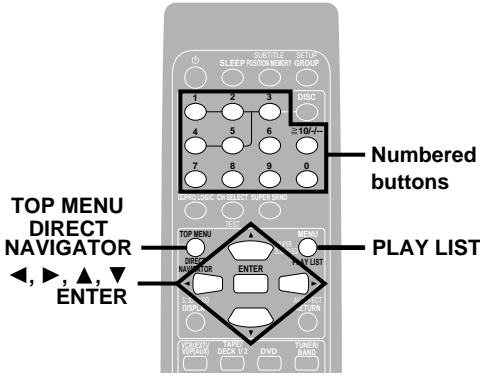

A

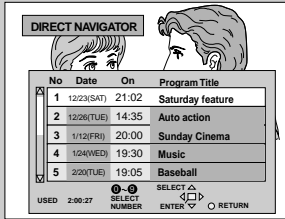

B

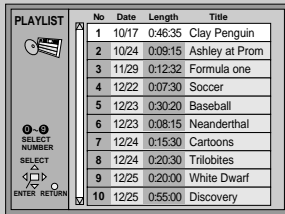

C

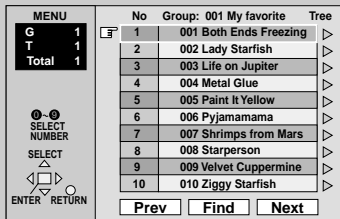

D

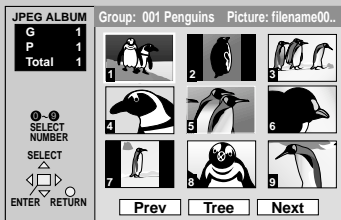

Navigation menus

Remote control only

Track title search

[WMA] [MP3] [CD] (CD text only)

Example: finding a track including the word "LOVE"

- 1 While the menu is displayed (⇒ page 22)
Press [**▲**, **▼**] to select "Find" and press [ENTER].
[A]
- 2 Press [**▲**, **▼**] to select "L" and press [ENTER].
Characters change in alphanumeric order each time you press [**▲**].
Repeat this step to enter "O", "V", and "E".
 - Press [SKIP] (◀◀ or ▶▶) to skip between A, E, I, O, and U.
 - Only uppercase appear but the search also includes lower case.
 - Press [◀] to erase a character.
 - You can erase the asterisk (*) to search for the first word in a title.
 - You can enter numbers with the numbered buttons.
- 3 Press [**▶**] to select "Find" and press [ENTER].
The search results screen appears.
- 4 Press [**▲**, **▼**] to select the track and press [ENTER].

To return to the menu

Press [RETURN].

To use the tree screen to find a group

[WMA] [MP3] [JPEG]

- 1 While the menu is displayed (⇒ page 22)
[WMA] [MP3]
Press [**▶**] while a track is highlighted to display a tree screen. [B]
[JPEG]
Press [**▲**, **▼**, **◀**, **▶**] to select "Tree" and press [ENTER].
- 2 Press [**▲**, **▼**, **◀**, **▶**] to select a group and press [ENTER].
The audio navigation menu/album display for the group appears.

To return to the menu

Press [RETURN].

To use the contents screen to find a track

[CD] (CD text only)

You can use the text information recorded on these discs to find a track to play.

- 1 While the menu is displayed (⇒ page 22)
Press [**▶**] while a track is highlighted to display the contents screen. [C]
- 2 Press [**◀**, **▶**] to move through the tracks and press [ENTER].

To return to the menu

Press [RETURN].

See page 48 for more information about WMA, MP3, and JPEG.

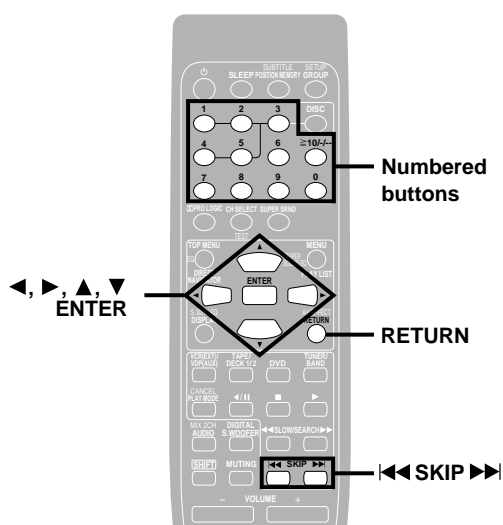

A

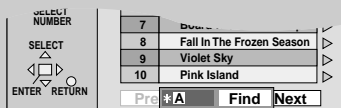

B

Example **MP3**

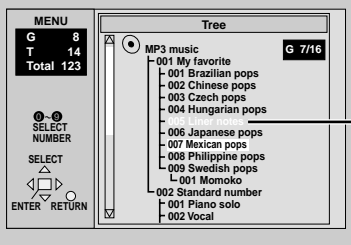

You cannot select groups that contain no compatible files.

C

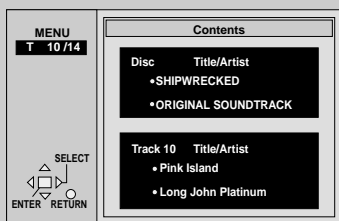

Using GUI screens

[RAM] [DVD-A] [DVD-V] [VCD] [CD] [WMA] [MP3] [JPEG]

Remote control only

GUI screens are menus that contain information about the disc or unit. These menus allow you to perform operations by changing this information.

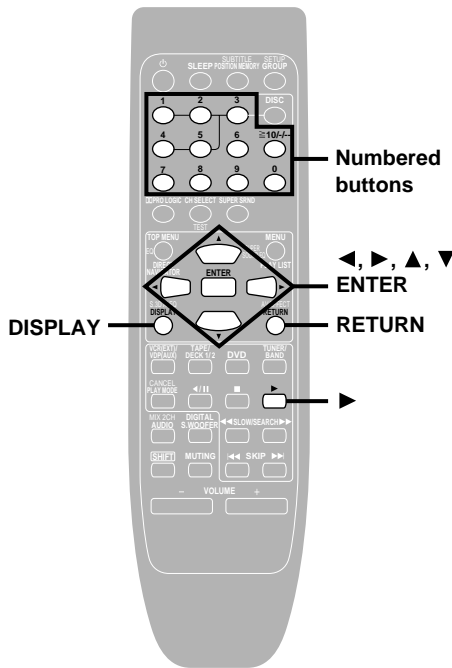

Common procedures

- 1 Press [DISPLAY].**
Each time you press the button:
Disc information (→ page 25) → Progress indicator (→ below)
Original display ← Unit information (→ page 26)
- 2 [Unit information only]**
While the leftmost icon is highlighted
Press [▲, ▼] to select the menu.
Each time you press the button:
Play menu ↔ Display menu
Picture menu ↔ Audio menu
- 3 Press [◀, ▶] to select the item.**
- 4 Press [▲, ▼] to select the setting.**
 - Items with "▲" or "▼" above and below can be changed by [▲, ▼].
 - Press [ENTER] if the setting does not change after pressing [▲, ▼].
 - Some items require different operations. Read the explanations on the following pages.

A Example [DVD-V]

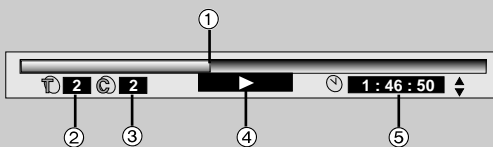

For your reference

- Depending on the condition of the unit (playing, stopped, etc.) and the type of software you are playing, there are some items that you cannot select or change.
- When numbers are displayed (e.g. title No.), the numbered buttons are also effective for setting. After entering the numbers, press [ENTER] to register the setting.

To clear the menus

Press [RETURN] until the menus disappear.

■ To change the position of the icons

- 1 Press [◀, ▶] to select the rightmost icon.
- 2 Press [▲, ▼] to move the icons.
(There are 5 positions.)



A Progress indicator

Indicates how far you have played through an item.

① **Current position** [RAM] [DVD-A] [DVD-V] [VCD] [CD] [WMA] [MP3]

② **PG: Program number** [RAM]

PL: Play list number [RAM]

T: Title number [DVD-V]

Track number [VCD] [CD]

G: Group number [DVD-A] [WMA] [MP3] [JPEG]

③ **T: Track number in group** [DVD-A] [WMA] [MP3]

C: Chapter number [DVD-V]

P: Picture number [JPEG]

④ **Condition - play, pause, or slow/search**

[RAM] [DVD-A] [DVD-V] [VCD] [CD] [WMA] [MP3]

Play speed (→ below)

⑤ **Changing the time display** [RAM] [DVD-A] [DVD-V] [VCD] [CD]

Press [▲, ▼] to show the elapsed play time or remaining time for the program, play list, track or title.

Elapsed play time [WMA] [MP3]

(display only, cannot be changed)

Changing play speed

[DVD-A] (Motion picture parts only) [DVD-V] (Dolby Digital only)

You can slow down or speed up play.

During play

Press [◀] (slower) or [▶] (faster).

There are five speeds:

×0.8 ↔ ×0.9 ↔ ×1.0 (normal speed) ↔ ×1.2 ↔ ×1.4

After you change the speed, output is in stereo.

Sound is stereo as long as "×1.0" is orange.

To return to normal play (surround sound), press [▶] (play) or [ENTER].

Normal play is also restored when you return the speed to ×1.0 and clear the progress indicator.

Unless otherwise indicated, select items with [◀, ▶] and change with [▲, ▼].

Disc information

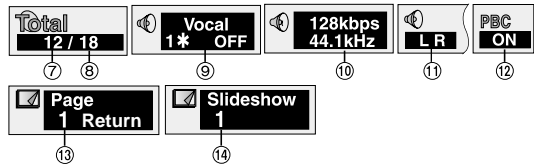
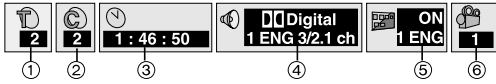

①	PG: Program number [RAM] PL: Play list number [RAM] G: Group number [DVD-A] [WMA] [MP3] [JPEG] T: Title number [DVD-V] Track number [VCD] [CD]	[▲, ▼] ↓ [ENTER]
②	T: Track number in group [DVD-A] [WMA] [MP3] C: Chapter number [DVD-V] P: Picture number [JPEG]	[ENTER]
③	Time [RAM] [DVD-A] [DVD-V] Select a position to start play by specifying a time.	Numbered buttons ↓ [ENTER]
	Changing the time display [RAM] [DVD-A] [DVD-V] [VCD] [CD] ([WMA] [MP3] Display only) ↳ Elapsed play time for the program, play list, title or track ↑ ↓ Remaining time for the group ((DVD-A) or disc ([VCD] [CD]) ↑ ↓ ↳ Remaining time for the program, play list, title or track	
④	Soundtrack language (⇒ page 17) [DVD-A] [DVD-V]	
⑤	Subtitle language (⇒ page 17) [DVD-A] [DVD-V] Subtitles on/off [RAM] [DVD-A] [DVD-V] Track information on/off [WMA] [MP3] [CD] (CD text only) Picture information [JPEG] Full: Group title, picture title, file size, picture size, date of shooting, and camera model used.* Date: Date of shooting only. OFF: No display. *Actual displays depend on the camera and condition of the data.	
⑥	Angle number [DVD-A] [DVD-V] Rotating pictures [JPEG] 0 ↔ 90 ↔ 180 ↔ 270 ↑ ↺ ↻ ↓	

⑦	Track/picture number in disc [WMA] [MP3] [JPEG]	[▲, ▼] ↓ [ENTER]
⑧	Total number of tracks/pictures on disc [WMA] [MP3] [JPEG]	Display only
⑨	Karaoke vocal on/off [DVD-V] (Karaoke DVD only) If a DVD title is a duet, select V1 or V2 to duet with the unit.	
⑩	Current bitrate (kbps) [WMA] [MP3] Current sampling frequency (kHz) [WMA] [MP3]	Display only
⑪	Audio mode [RAM] (⇒ page 17) LR ↔ L ↔ R ↑ ↺ ↻ ↓	
⑫	Menu play [VCD] (with playback control only)	Display only
⑬	Still picture number [DVD-A] • To return to page 1 [◀, ▶] ⇒ Select "Return" ⇒ [ENTER]	
⑭	Slideshow [DVD-A] Picture number	Display only
	Slideshow setting on/off [JPEG] Slideshow timing [JPEG] 0–30 sec	

Audio/Subtitle language

ENG: English	SVE: Swedish	CHI: Chinese
FRA: French	NOR: Norwegian	KOR: Korean
DEU: German	DAN: Danish	MAL: Malay
ITA: Italian	POR: Portuguese	VIE: Vietnamese
ESP: Spanish	RUS: Russian	THA: Thai
NLD: Dutch	JPN: Japanese	*: Others

Unit information

Play menu

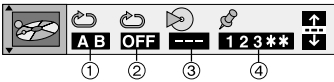

①	A-B repeat (⇒ page 19) [RAM] [DVD-A] [DVD-V] [VCD] [CD] [WMA] [MP3]	[ENTER]
②	Repeat mode (⇒ page 19) [RAM] [DVD-A] [DVD-V] [JPEG]	
③	Play mode (⇒ page 19) [DVD-A] ---: Normal play ALL: All group play	Display only
④	Marker [RAM] [DVD-A] [DVD-V] [VCD] [CD] [WMA] [MP3] [JPEG]	⇒ page 18

Audio menu

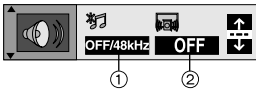

①	Double re-master (⇒ page 30) [RAM] [DVD-A] [DVD-V] [CD] [WMA] [MP3]
②	Dialogue Enhancer on/off [DVD-V] (Discs where the dialogue is recorded in the center channel) This makes the dialogue in movies easier to hear.

Display menu

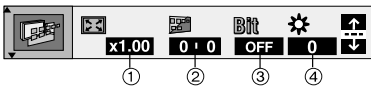

①	Zoom (⇒ page 18) [RAM] [DVD-A] [DVD-V] [VCD]
②	Subtitle Position/Brightness [DVD-A] [DVD-V] ● Position (0 to -60): in 2 unit steps ● Brightness (Auto*/0 to -9) *The brightness adjusts automatically against the background.
③	Bitrate display on/off [RAM] [DVD-A] [DVD-V] [VCD] During play: shows the bitrate(approximate values) of the video being played While paused: shows the data volume of the frame and type of picture (⇒ page 48, Glossary—I/P/B) <div style="border: 1px solid black; padding: 5px; margin: 10px 0;"> <p>9.438 Mbps ▶</p> <p>↕ [◀, ▶]</p> </div> <div style="border: 1px solid black; padding: 5px; margin: 10px 0;"> <p>• Bit rate</p> <p>Cur. 7.507 Mbps</p> <p>Ave. 6.730 Mbps</p> <p style="text-align: right;">5.0 Mbps</p> </div> <p>Current bitrate A record of bitrates for a sample period.</p> <p style="text-align: center;">Average bitrate</p>
④	OSD brightness (-3 to +3) Adjust the brightness of the on-screen displays.

Picture menu

[RAM] [DVD-A] [DVD-V] [VCD] [JPEG]

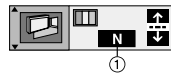

①	Picture mode (⇒ page 17, Cinema) ● N : Normal mode ● S : Soft mode (Soft picture with fewer video artifacts) ● F : Fine mode (Details are sharper) ● C1 : Mellows images and enhances detail in dark scenes ● C2 : Sharpens images and enhances detail in dark scenes ● U1/U2 : User mode (⇒ below)
---	--

To change the user mode

- 1 Select User mode and press [▶] to highlight the number.
- 2 Press [▲, ▼] to select "1" or "2".



U1: MPEG D.N.R. (Digital Noise Reduction)

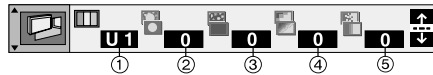

②	Depth Enhancer (0 to +4) Reduces the rough noise in the background to give a greater feeling of depth.
③	3D-NR (0 to +4)/ Dot NR (On) Reduces overall noise/Reduces the dot noise that occurs at the borders between colors.
④	Block NR (0 to +3) Smooths block noise.
⑤	Mosquito NR (0 to +3) Reduces the smudging that appears around contrasting sections of the picture.

U2

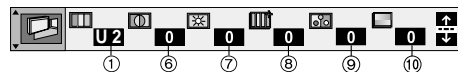

⑥	Contrast (-7 to +7) Increases the contrast between light and dark parts of the picture.
⑦	Brightness (0 to +15) Brightens the picture.
⑧	Sharpness (-7 to +7) Adjusts the sharpness of the edges of the horizontal lines.
⑨	Colour (-7 to +7) Adjust the shade of the picture's colour.
⑩	Gamma (0 to +5) Emphasis of outlines.

The radio: manual tuning

Radio stations can be tuned manually by selecting the station's frequency or they can be preset into channels to make it easy to tune (→ page 28).

Preparation: Press [⏻/⏹] to turn the unit on.

1 Press [TUNER/BAND] to display FM or AM on the tuner/amplifier.

Each time you press the button: FM ↔ AM

2 Press [TUNING MODE] to display "MANUAL" on the tuner/amplifier.

Each time you press the button: MANUAL ↔ PRESET

3 Press [TUNING (∨ or ∧)] to tune in the desired broadcast.

If you press and hold [TUNING (∨ or ∧)] for a moment, the frequency starts changing automatically. It stops when a station is found.

It may also stop if there is outside interference. Press and hold [TUNING (∨ or ∧)] again to restart. You can also stop the frequency changing by pressing [TUNING (∨ or ∧)].

"TUNED" is displayed when a radio station is tuned.

"ST" is displayed when a stereo FM broadcast is being received.

4 Adjust the volume.

A If noise is excessive in FM

Press [FM AUTO/MONO] to display "MONO".

This mode improves sound quality if reception is weak for some reason but broadcasts are heard in monaural.

Press [FM AUTO/MONO] again to cancel the mode. "MONO" goes out.

MONO is also canceled if the frequency is changed.

Turn off "MONO" for normal listening. Stereo and monaural broadcasts are automatically played as they are received.

Stations can be preset in monaural. Carry out presetting manually (→ page 28).

B RDS broadcasting

[For the United Kingdom, Continental Europe and Russia]

This unit can display the text data transmitted by the radio data system (RDS) available in some areas.

If the station you are listening to is transmitting RDS signals, "RDS" will light up on the display.

Displaying the text data

Press [PS-DISP MODE] to display a station name.

Press [DISP MODE-PTY] to display a program type.

Each time you press the button:

Frequency display ↔ PS or PTY display

Note

RDS displays may not be available if reception is poor.

*"M.O.R M"="Middle of the road music".

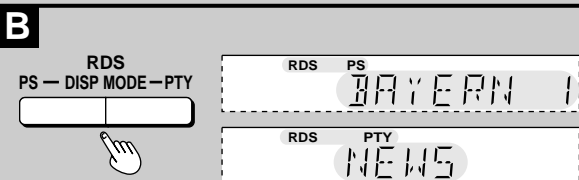
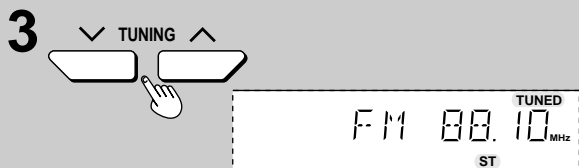
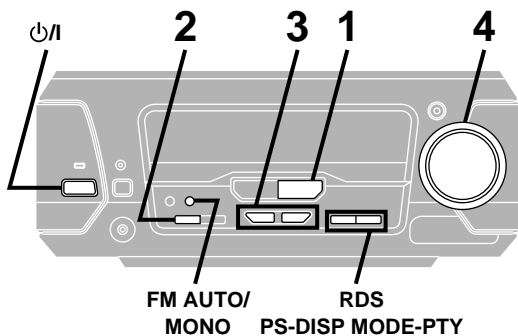
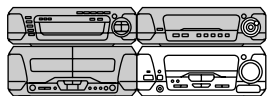

PTY displays

NEWS	VARIED	FINANCE	COUNTRY
AFFAIRS	POP M	CHILDREN	NATIONAL
INFO	ROCK M	SOCIAL A	OLDIES
SPORT	M.O.R M*	RELIGION	FOLK M
EDUCATE	LIGHT M	PHONE IN	DOCUMENT
DRAMA	CLASSICS	TRAVEL	TEST
CULTURE	OTHER M	LEISURE	ALARM
SCIENCE	WEATHER	JAZZ	

The radio: preset tuning

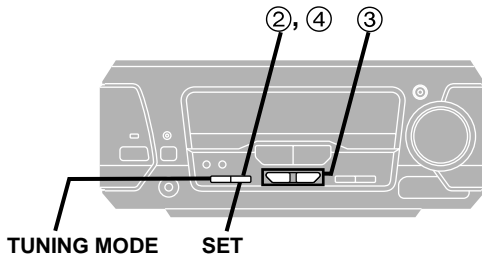
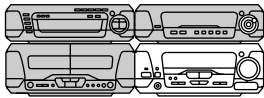

There are two methods of presetting stations.

Automatic presetting: The stations the tuner can receive are preset.

Manual presetting: You can select the stations to preset and the order they are preset in.

There are 39 channels available for presetting.

A Automatic presetting

Do the following once each for FM and AM.

Preparation: Tune to the frequency presetting is to begin at (➔ page 27).

Hold down [SET].

Release the button when "AUTO MEMORY" appears on the tuner/amplifier. The tuner presets all the stations it can receive into the channels in ascending order. FM stations are preset into channels 1 to 39, and AM stations are preset into channels 21 to 39.

"SET OK" is shown when presetting is complete and the last station to be preset is played.

"ERROR" is displayed if the tuner doesn't receive any stations. Do presetting manually if this happens (see below).

Note

AM stations replace any FM channels that were preset in channels 21 to 39.

B Manual presetting

Preset the stations one at a time.

- ① Tune to the required station.
- ② Press [SET].
- ③ Press [TUNING (∨ or ∧)] to select a channel.
- ④ Press [SET].

The station occupying a channel is erased if another station is preset in that channel.

C Selecting channels

Preparation: Press [⏻] to turn the unit on.

On the remote control

- 1 Press [TUNER/BAND].
- 2 Press the numbered buttons to select the channel.
For channels 1 to 9 press the corresponding number.
For channels 10 or over press [≥10/-/→], then the two digits.
e.g. To select channel 21: [≥10/-/→]→[2]→[1]
- 3 Adjust the volume.

On the main unit

- ① Select "PRESET" with [TUNING MODE].
- ② Press [TUNING (∨ or ∧)] to select the channel.

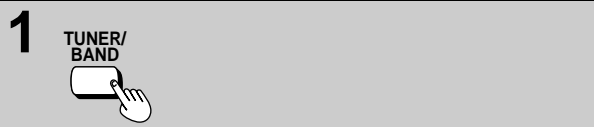
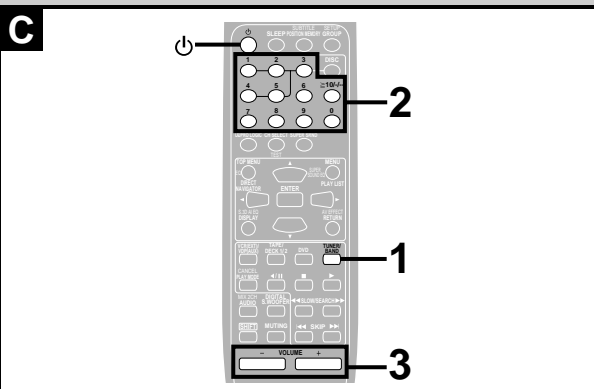
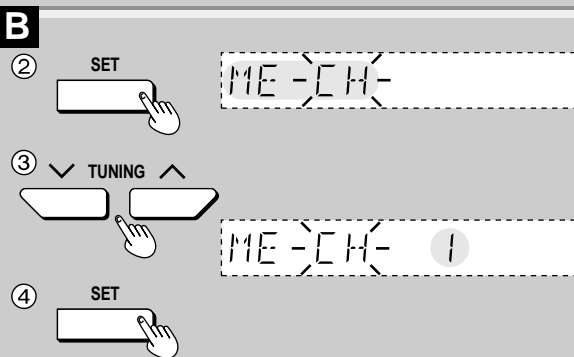
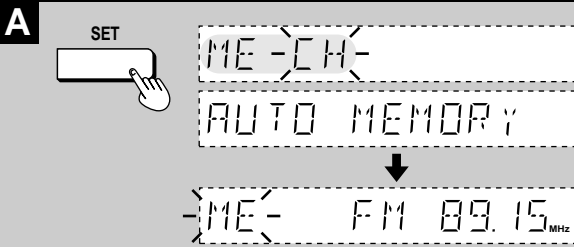

Cassette tapes

See page 3 for tape selection.

Preparation: Press [⏻/⏮] to turn the unit on.

- 1 Press [▲ OPEN] on deck 1 or deck 2 and insert the cassette with a tape facing down.

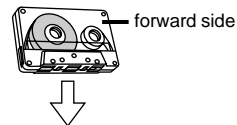

Close the holder by hand.

- 2 Press [DOLBY NR] to select Dolby NR on ("DD NR" appears on the tuner/amplifier) or off.
- 3 Press [REV MODE] to select the reverse mode. The indicator on the tuner/amplifier changes each time you press the button:
 - ↔: One side is played.
 - ↔↔: Both sides are played.
 - ↔↔↔: Both sides are played 8 times each.
- 4 Press [◀] (reverse side) or [▶] (forward side). Play begins and the play indicator changes to green.
- 5 Adjust the volume.

To stop the tape

Press [■].

[A] To change the deck to be used

Press [DECK 1/2] to select the deck you want to play.

To listen to 2 tapes consecutively

Insert a tape into each deck and select "↔↔". Both tapes will be played 8 times each.

B Finding a place on a tape

To fast-forward and rewind

Press [◀◀] or [▶▶] while the tape is stopped.

To find the beginning of a track (TPS: Tape program sensor)

Press [◀◀] or [▶▶] during play.

Play resumes from the beginning.

Tape direction	rewind	fast-forward
▶	◀◀	▶▶
◀	▶▶	◀◀

• Each deck's play direction is stored in the system's memory.

• You can fast-forward or rewind the tape while you are playing or recording a tape in another deck.

Press [DECK 1/2] to switch to the deck not playing, and then press [◀◀] or [▶▶]. After the above operation, be sure to press [DECK 1/2] to reselect the deck playing.

Note

TPS may not operate correctly in the following situations:

If the interval between tracks is less than 4 seconds.

If there is noise between tracks.

If there are silent parts within tracks.

Dolby noise reduction

Dolby NR reduces "hissing" when playing tapes. It increases the high frequency region when recording and then reduces it in playback. Use the same system during playback and recording. This unit has Dolby B NR which reduces noise to a third.

Prerecorded cassettes and equipment marked "DDNR" use Dolby B NR.

Manufactured under license from Dolby Laboratories.

"Dolby" and the double-D symbol are trademarks of Dolby Laboratories.

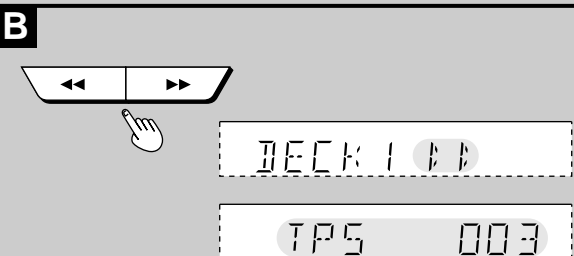
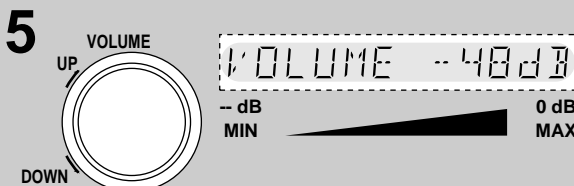
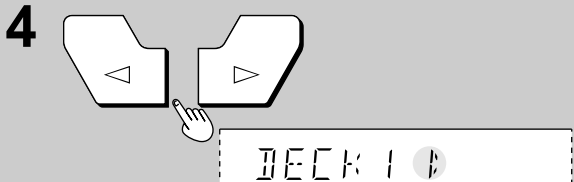
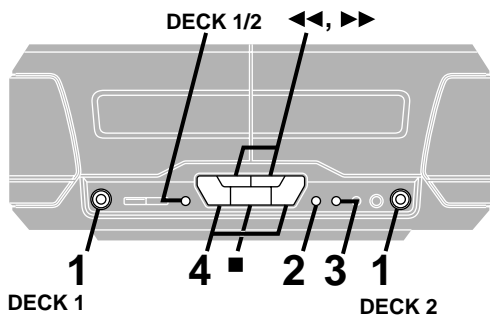
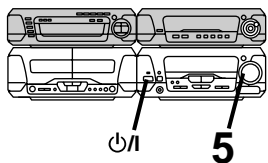

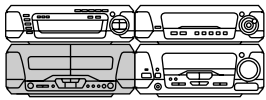

DOUBLE RE-MASTER

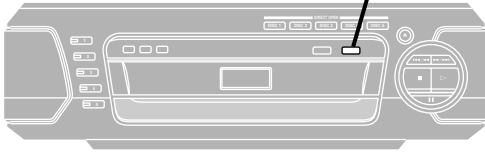

SUPER SOUND EQ

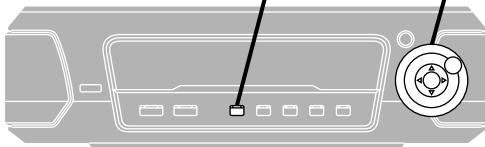

DIGITAL S. WOOFER

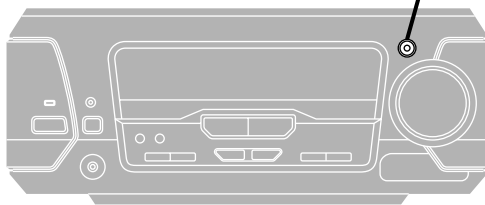

A Boosting the super woofer

Boosting the super woofer adds power to the bass.

Press **[DIGITAL S.WOOFER]**.

The indicator turns green.

The display on the tuner/amplifier changes each time you press the button:

MID (medium) → MAX (high) → cancel (off)

There is only one level when listening through headphones.

To cancel

Press **[DIGITAL S.WOOFER]** to turn the indicator off.

B Using the super sound equalizer

Turning on the super sound equalizer gives you a more powerful sound.

Press **[SUPER SOUND EQ]**.

The indicator turns green.

To cancel

Press **[SUPER SOUND EQ]** so the indicator turns orange.

C Double re-master—Enjoying more natural sound

[RAM] [DVD-A] [DVD-V] [CD]

Discs recorded with 2-channel LPCM at 44.1 kHz or 48 kHz

This feature gives you a more natural sound by adding higher frequency signals not recorded on the disc.

[WMA] [MP3]

Discs recorded at 44.1 kHz or 48 kHz

This feature reproduces the frequencies lost during recording to give you a sound closer to the original.

During play

Press **[DOUBLE RE-MASTER]**.

DOUBLE RE-MASTER indicator lights up.

Each time you press the button:

Setting	[RAM] [DVD-A] [DVD-V] [CD] Type of music	[WMA] [MP3] Effect level
1	High tempo (e.g., pops and rock)	Light
2	Various tempos (e.g., jazz)	Medium
3	Low tempo (e.g., classical)	Strong
OFF	off	off

D Changing sound field and quality

Turn **[MULTI JOG]** to select a setting.

The display on the sound processor changes each time you turn the jog:

HEAVY: Adds punch to rock.

CLEAR: Clarifies higher sounds.

SOFT: For background music

HALL: Expands sound to make you feel like you were in a hall.

AI-EQ: Adjust sound with the acoustic image equalizer (⇒ page 31).

M.EQ: Create your own effects (⇒ page 31).

FLAT: Canceled (no effect is added).

On the remote control

Press **[SHIFT]+[EQ]**.

To cancel

Turn **[MULTI JOG]** to select "FLAT".

Note

Turn off the effect if sound quality reduces when using HALL with a source.

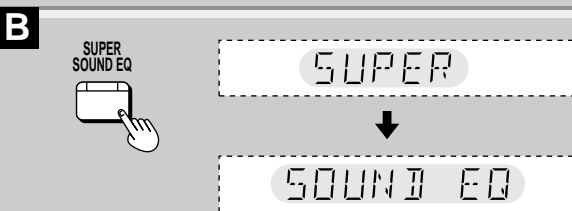
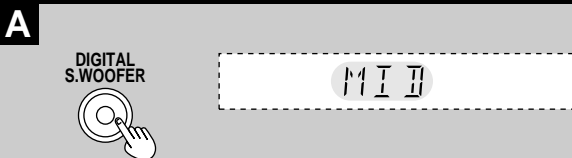

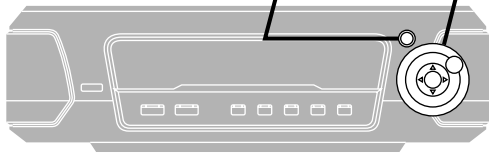
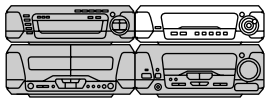

A

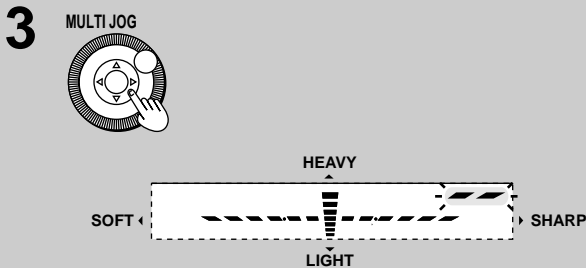
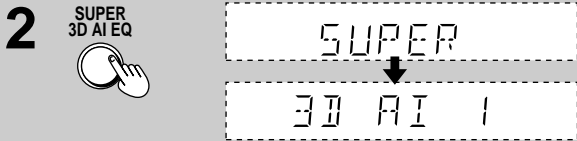
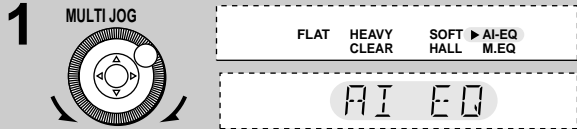

B

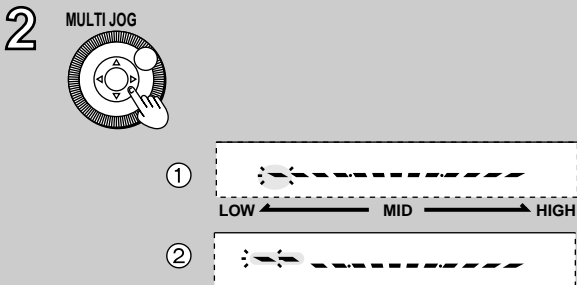
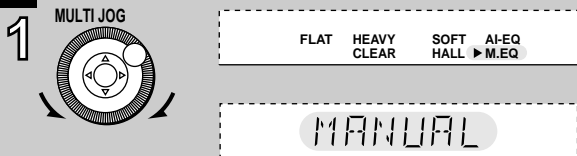

A Using the acoustic image equalizer (AI EQ)

Achieve subtle sound quality settings with the soft, sharp, heavy, and light coordinates.

- 1 Turn [MULTI JOG] to display "AI-EQ" on the sound processor.**
- 2 Press [SUPER 3D AI EQ] to select the surround level.**

Each time you press the button:
AI EQ → SUPER 3D AI 1 → SUPER 3D AI 2

SUPER 3D AI 1: Adds a surround effect to the AI EQ.
SUPER 3D AI 2: Adds a stronger surround effect to the AI EQ.

- 3 Change the sound quality with [◀, ▶, ▲, ▼].**

Adjust softness and sharpness with [◀, ▶].
Adjust heaviness and lightness with [▲, ▼].
The original display is restored on the display panel in about 5 seconds.

To cancel

Turn [MULTI JOG] to select "FLAT".

The changes you make are stored and automatically recalled the next time you select AI EQ.

Note

- Turn off the effect if sound quality reduces when using SUPER 3D AI EQ with a source.
- You cannot select "SUPER 3D AI 1" or "SUPER 3D AI 2" while:
 - Using a surround system (⇒ page 32)
 - Karaoke mode is on (⇒ page 42)
 - Listening to the radio
 - Playing a DVD (except for MIX 2CH mode, ⇒ page 33)
 - Using headphones

B Using the manual equalizer (M.EQ)

Create your own sound quality effects.

- 1 Turn [MULTI JOG] to display "M.EQ" on the sound processor.**
- 2 Change the sound quality with [◀, ▶, ▲, ▼].**
 - ① Select the sound range to be adjusted with [◀] or [▶].
 - ② Adjust the level with [▲] or [▼].

Repeat step 2 to set the desired sound quality.

The original display is restored on the display panel in about 5 seconds.

To cancel

Turn [MULTI JOG] to select "FLAT".

Note

The changes you make are stored and automatically recalled the next time you select the manual equalizer.



Enjoying surround sound

The following chart gives a summary of this unit's surround features. It also shows additional effects that can be used to enhance your enjoyment.

Note

- All the features are only effective if speakers are used.
- You may experience a reduction in sound quality when these surround systems and effects are used with some sources. If this occurs, turn the surround system or effect off.

When you turn on one of the surround systems, the indicators for the additional effects you can use also light.

Surround system	Features	Software	Additional effects See below for details.
DOLBY DIGITAL and DTS (⇒ page 33)	<ul style="list-style-type: none"> • Dolby Digital and DTS are digital encoding systems used on DVD to carry surround sound. Both were originally developed for use in cinemas. • This unit automatically recognizes and decodes these systems. 	<p>Software encoded with Dolby Digital can be identified with this mark.</p>  <p>Software encoded with DTS can be identified with this mark.</p>  <ul style="list-style-type: none"> • DVD 	<ul style="list-style-type: none"> (A) CENTER FOCUS (B) VIRTUAL REAR SURROUND (C) MULTI REAR SURROUND (D) SEAT POSITION
DOLBY PRO LOGIC (⇒ page 33)	<ul style="list-style-type: none"> • This unit has built-in Dolby Pro Logic circuitry so you can enjoy Dolby Surround. • Dolby Pro Logic is a decoding system that was developed to get a better sense of presence from sources encoded with Dolby Surround. The feeling of position has been improved by the addition of a separate center speaker channel. 	<p>Software encoded with Dolby Surround can be identified with this mark.</p>  <ul style="list-style-type: none"> • DVD • Video CD • CD • Laser Disc • Video tape 	<ul style="list-style-type: none"> (A) CENTER FOCUS (B) VIRTUAL REAR SURROUND (C) MULTI REAR SURROUND (D) SEAT POSITION
SUPER SURROUND (⇒ page 33)	<ul style="list-style-type: none"> • This mode adds surround effects to movie software that hasn't been recorded with the above systems. • In MOVIE mode you can adjust the volume of the surround speakers to get the best surround effect. 	Any stereo sound source except for the radio.	<ul style="list-style-type: none"> (B) VIRTUAL REAR SURROUND (C) MULTI REAR SURROUND (D) SEAT POSITION
MOVIE MUSIC	This mode adds surround effects to stereo sources.		

Additional Effects

(A) CENTER FOCUS (⇒ page 34)

- This mode makes it seem like the sound from the center speaker is coming from within the television.
- The center speaker should be placed above the television.

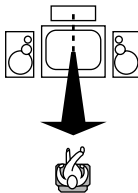

(C) MULTI REAR SURROUND (⇒ page 34)

- This mode makes it seem like there are multiple surround speakers in your room, increasing the cinema-like atmosphere.

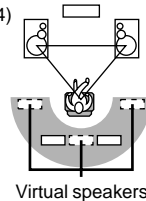

(B) VIRTUAL REAR SURROUND

(⇒ page 34)

- This mode is useful if you have to place your surround speakers near the front speakers due to the layout of your room.
- This mode makes it seem like the sound from the surround speakers is coming from behind you.

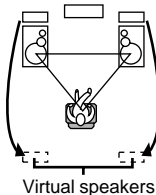

(D) SEAT POSITION (⇒ page 34)

- This mode helps maintain the sound position even if the listening position itself is changed.

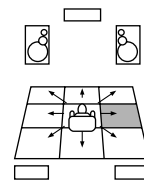

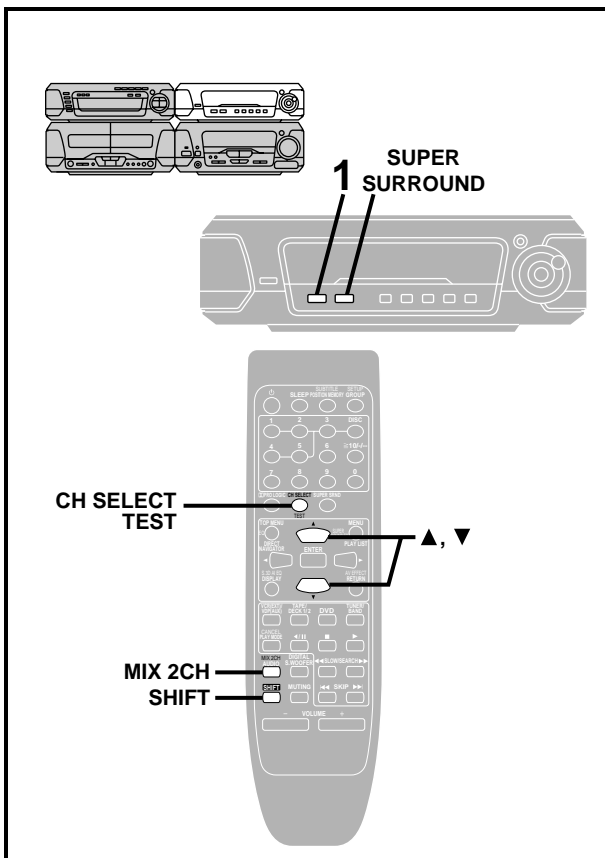

SUPER SURROUND

Press [SUPER SURROUND] and select "MOVIE" or "MUSIC".

The indicator turns green.

The display on the tuner/amplifier changes each time you press the button:
MUSIC → MOVIE → STEREO SOUND* (off)

*Original display when playing DVDs

To cancel

Press [SUPER SURROUND] to select "STEREO SOUND". The indicator goes out.

Note

Turn SUPER SURROUND off when playing a DVD recorded with 5.1-channel Dolby Digital or DTS. The surround effects will not be reproduced correctly if this is left on.

Speaker level adjustments

Remote control only

DOLBY DIGITAL and DTS, DOLBY PRO LOGIC

If the level of the speakers appears to be different while listening to a source, adjust the levels of the speakers to the same apparent level.

Preparation: Set the volume level of the front speakers normally used for enjoying the source.

- ① While stopped
Press [SHIFT]+[TEST] to output a test signal.
A test signal is output from each speaker in order.
To stop the test signal, press [SHIFT]+[TEST] again.
Lch: Front left speaker
Cch: Center speaker
Rch: Front right speaker
RSch: Right surround speaker
LSch: Left surround speaker
(No signal is output for the subwoofer.)
● The surround channel for Dolby Pro Logic is monaural so the indicator appears as "Sch" instead.
- ② While the speaker to be adjusted is outputting a signal
Press [▲] (to increase the level) or [▼] (to decrease the level).
The level of the speaker changes.
Repeat step ② as desired.

To adjust the levels during play

- ① Press [CH SELECT] to select the speaker.
Each time you press the button:

In Dolby Digital and DTS

Lch → Cch → Rch → RSch → LSch → SWch

SWch: Subwoofer (Adjust only when connected)

In Dolby Pro Logic

Lch → Cch → Rch → Sch

- ② Press [▲] or [▼] to adjust the level.

SUPER SURROUND

While playing a source

1. Press [CH SELECT].
2. Press [▲] (to increase level) or [▼] (to decrease level).

Manufactured under license from Dolby Laboratories.

"Dolby", "Pro Logic" and the double-D symbol are trademarks of Dolby Laboratories.

Manufactured under license from Digital Theater Systems, Inc. US Pat. No. 5,451,942, 5,956,674, 5,974,380, 5,978,762 and other worldwide patents issued and pending. "DTS" and "DTS Digital Surround" are registered trademarks of Digital Theater Systems, Inc. Copyright 1996, 2000 Digital Theater Systems, Inc. All rights reserved.

DOLBY DIGITAL and DTS

Play a DVD encoded with Dolby Digital or DTS.

"DIGITAL" or "DTS" appears on the tuner/amplifier.

To down-mix Dolby Digital or DTS (5.1ch) signals to 2 channels

Press [SHIFT]+[MIX 2CH].

To cancel

Press [SHIFT]+[MIX 2CH] again.

When "D.MIX" is flashing [DVD-A]

The DVD-Audio contains multiple-channel signals that cannot be down-mixed.

DOLBY PRO LOGIC

1 Press [PRO LOGIC, OFF/ON].

The indicator turns green.

2 Playback a Dolby Surround source.

To cancel

Press [PRO LOGIC, OFF/ON] so the indicator turns off.

Note

- This does not work when playing multi-channel Dolby Digital.
- Turn Dolby Pro Logic off when playing a DVD recorded with 5.1-channel Dolby Digital or DTS. The surround effects will not be reproduced correctly if this is left on.

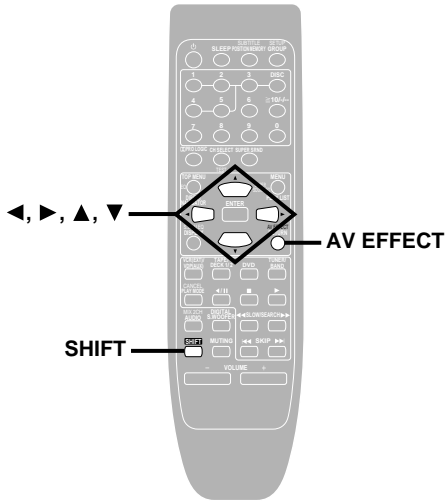
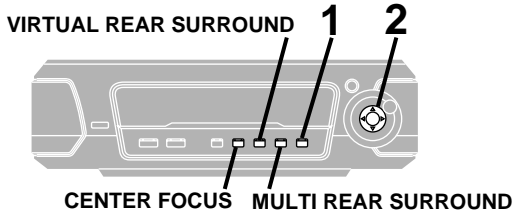
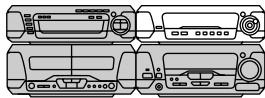

Surround effects

These effects can be used with the surround systems described on page 32. These effects are available when the corresponding indicators are alight.

A CENTER FOCUS

(Discs where the dialogue is recorded in the center channel)

Press [CENTER FOCUS].

The indicator turns green.

Dialogue enhancer is canceled when you turn this on (→ page 26).

To cancel

Press [CENTER FOCUS] so the indicator turns orange.

B VIRTUAL REAR SURROUND

Press [VIRTUAL REAR SURROUND].

The indicator turns green.

To cancel

Press [VIRTUAL REAR SURROUND] so the indicator turns orange.

C MULTI REAR SURROUND

Press [MULTI REAR SURROUND].

The indicator turns green.

To cancel

Press [MULTI REAR SURROUND] so the indicator turns orange.

D SEAT POSITION

1 Press [SEAT POSITION].

The indicator flashes green.

2 While the indicator is flashing (within 10 seconds) Adjust the seat position with [◀, ▶, ▲, ▼].

The indicator flashes for 10 seconds then lights green.

To cancel

1. Press [SEAT POSITION] so the indicator flashes.
2. Press [SEAT POSITION] again while the indicator is flashing so it turns orange.

Note

- The seat position is remembered by the unit and is reactivated when you turn seat position on again.
- When used with virtual rear surround, seat position is changed in 3 steps. [E]

On the remote control

- ① Press [SHIFT]+[AV EFFECT].
- ② Press [◀] or [▶] so the surround effect indicators flash in order.
- ③ Press [▲] (ON).
- ④ (If you select SEAT POSITION) Adjust the seat position with [◀, ▶, ▲, ▼].

To turn it off, after steps ① and ② press [▼] so the indicator turns orange.

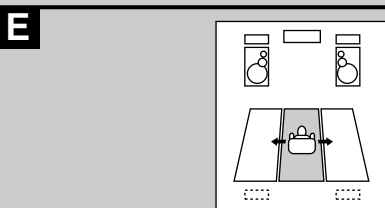
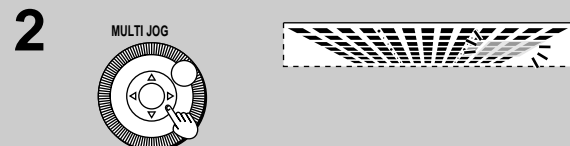

Before recording (Deck 2 only)

See page 3 for tape selection.

Volume, sound quality and surround effects have no effect on recording. Sound quality and surround effects are automatically set to flat when recording.

A B

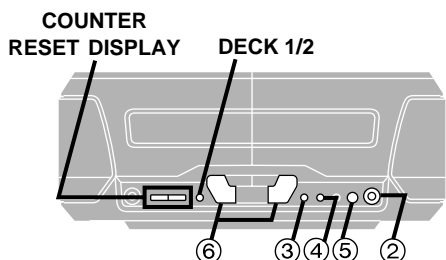
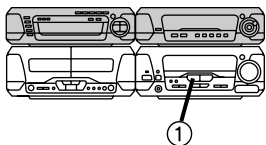

A



C

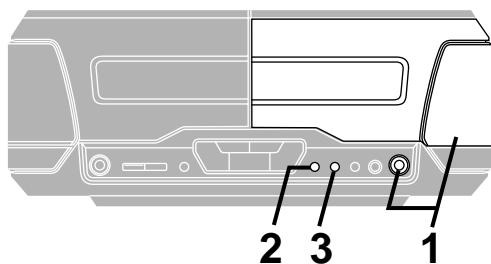

1



2

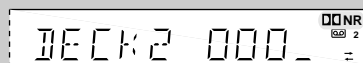

3

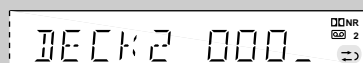

A To display the tape counter while recording

Press [COUNTER, DISPLAY].

The counter is displayed for about 5 seconds.

- Press [COUNTER, RESET] to reset the counter.
- To display or reset the tape counter for deck 1, first press [DECK 1/2].

B Erasing recordings

- ① Press [INPUT SELECTOR] to select "TAPE".
- ② Insert the recorded tape into deck 2.
- ③ Press [DOLBY NR] so the "DOLBY NR" indicator goes out.
- ④ Select the reverse mode.
- ⑤ Press [● REC PAUSE].
- ⑥ Press [◀] or [▶].

Erasure prevention

The illustration shows how to remove the tabs to prevent recording.

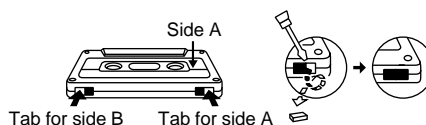

To record on the tape again, cover as shown, being careful not to cover the high position discrimination hole.

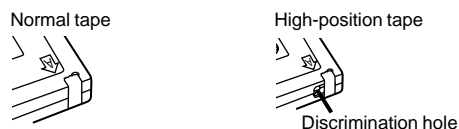

Your attention is drawn to the fact that recording pre-recorded tapes or discs or other published or broadcast material may infringe copyright laws.

C Preparatory steps

Do these steps before each recording.

Wind up the leader tape so recording can begin immediately.

- 1** Press [▲ OPEN] on deck 2 and insert the cassette with tape facing down.

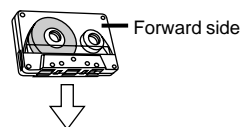

- 2** Press [DOLBY NR] to select Dolby NR on ("DOLBY NR" appears on the tuner/amplifier) or off. (→ "Dolby noise reduction", page 29)
- 3** Press [REV MODE] to select the reverse mode.

Each time you press the button:

- ↔: One side only records.
- ↔ and ↔: Both sides record (forward→reverse).

"↔" automatically changes to "↔" when [● REC PAUSE], [CD EDIT] or [TAPE EDIT] is pressed.

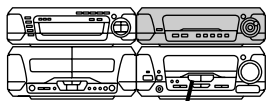

INPUT SELECTOR

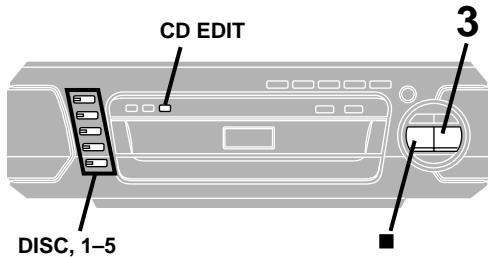
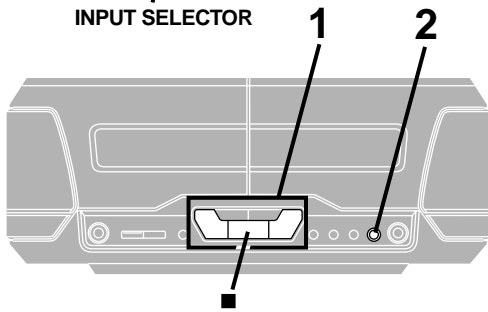

Recording discs

Preparation:

- Do the preparatory steps (⇒ page 35).
- Insert the disc(s) you want to record (⇒ page 14).
- Press [DISC, 1–5] to select the disc where you want to start recording, then press [■] to stop the disc.

A Normal recording

[RAM] [DVD-A] [DVD-V] [VCD] [CD] [WMA] [MP3]

1 Press [◀] (reverse side) or [▶] (forward side) then [■] to set the tape direction.

2 Press [● REC PAUSE].

The deck goes into the recording standby mode and the indicator “<” or “>” starts flashing.

3 Press [▶] on the DVD/Video CD/CD changer.

Recording starts automatically.

4 seconds after the disc(s) finishes, the deck goes into the recording standby mode.

To stop recording

EITHER

Press [■] on the changer.

The deck goes into the recording standby mode 4 seconds later.

OR

Press [■] on the deck.

Recording stops immediately but the disc continues to play.

To record programmed tracks [VCD] [CD]

Program tracks before step 1 (⇒ page 20).

B One touch disc editing

[VCD] [CD]

This function makes it easier for you to record from discs.

- When recording, if a track is cut off in the middle at the end of the front side, it is recorded from the beginning on the reverse side. (Ensure the “↔” reverse mode is selected.)

- At the end of the reverse side recording stops and the current track will be interrupted.

Ensure a Video CD or CD is in the play position tray.

Press [◀] or [▶] then [■] to set the tape direction, and press [INPUT SELECTOR] to select “DVD” as the source, then

Press [CD EDIT].

Recording starts. In the meantime, “CD EDIT” will scroll across the display.

The deck stops when recording finishes.

To stop editing

Press [■] on the changer.

The cassette deck also stops. “EDIT OUT” scrolls across the display.

To edit programmed tracks

Program the tracks (⇒ page 20) and press [CD EDIT].

For your reference:

- ALL DISC play can be combined (⇒ page 21).
- PBC on Video CDs is automatically canceled.
- “ERROR” is displayed if the disc in the playing position is a DVD or the resume function (⇒ page 14) is activated.

A

1

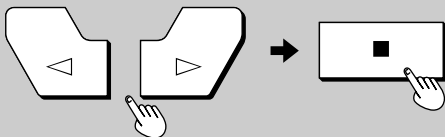

2



3

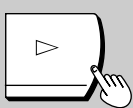

B

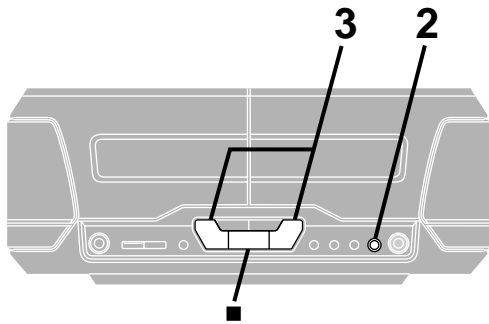
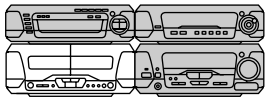

A**2**

● REC PAUSE

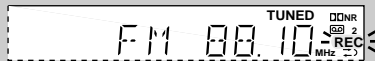
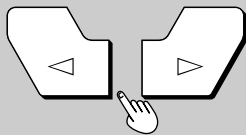
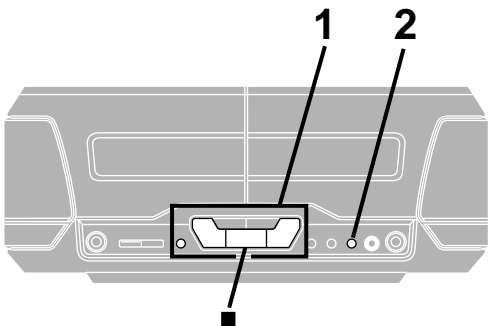
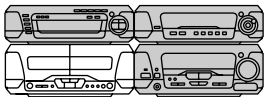
**3****B****1**

① DECK 1/2

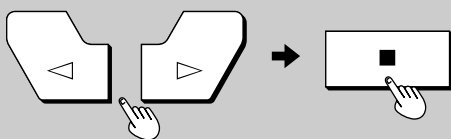

②

**2**

TAPE EDIT

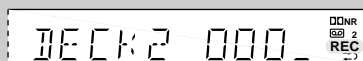
**A Recording the radio**

Preparation: Do the preparatory steps (⇒ page 35).

1 Tune to the required station.

(⇒ page 27, 28)

2 Press [● REC PAUSE].

The deck goes into the recording standby mode and the play indicator "◀" or "▶" starts flashing.

3 Press [◀] (reverse side) or [▶] (forward side) to start recording.**To stop recording**

Press [■].

To temporarily stop recording

Press [● REC PAUSE].

The deck goes into recording standby mode.

To resume recording press [◀] or [▶] with the flashing indicator.

B Tape-to-tape recording

Preparation:

- Do preparatory steps 1 and 3 (⇒ page 35).
- Insert the tape to be recorded in deck 1.

1 Set the tape direction on both decks.

- ① Press [DECK 1/2] to select "DECK 2".
- ② First press [◀] or [▶], and then [■].

Repeat steps ① and ② for deck 1.

2 Press [TAPE EDIT] to start recording.

The indicator "◀" or "▶" shows deck 2 direction.

If either deck 1 or deck 2 stops, the other deck also stops.

To stop recording

Press [■].

Both decks stop.

To enjoy another source while recording

Start playing the other source.

You can change the volume level and tone quality without affecting the recording.

Note

The recording level and the noise reduction effect of the original (playback) tape will be recorded on the new tape.

Using the timers

The play timer

This timer starts play of the selected source at the selected time. The displays in the illustrations show settings for preset radio channel 1 to play between 6:30 and 7:40 at -48 dB.

Preparation: Turn the unit on, set the time (⇒ page 12), preset radio stations if you want the timer to start playing the radio (⇒ page 28).

1 ① Press [CLOCK/TIMER] to display "ⓂPLAY" on the tuner/amplifier.

Each time you press the button:
CLOCK → ⓂPLAY → ⓂREC → Original display

② Press [SET] within 3 seconds.

2 Follow these steps to set items ① to ④.

① Press [TUNING (∨ or ∧)] to select the condition required and

② Press [SET].

① Start time

② Finish time

③ Source

TUNER ↔ DVD ↔ TAPE

↑ ↓

Insert a disc or tape if you select these sources.

If you select TUNER

Select a preset channel.

④ Volume

The play timer is now on standby. The display shows each condition again then restores the original display.

3 Press [Ⓜ/I] to turn the unit off.

ⓂPLAY/ⓂREC indicator remains illuminated to show the play (or record) timer is on.

The timer starts at the set time with the volume increasing gradually to the set level.

To cancel the timer

Press [ⓂPLAY/ⓂREC] so "ⓂPLAY" goes out.

Each time you press the button:

ⓂPLAY → ⓂREC → ⓂPLAY ⓂREC → Light off

The play timer will be canceled, but the settings stay in the memory.

For your reference:

When you insert cassettes in decks 1 and 2, deck 1 has priority.

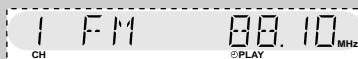
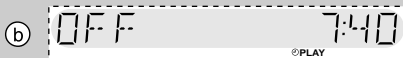
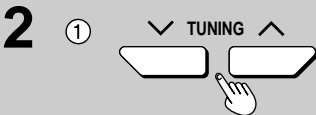
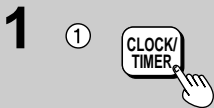
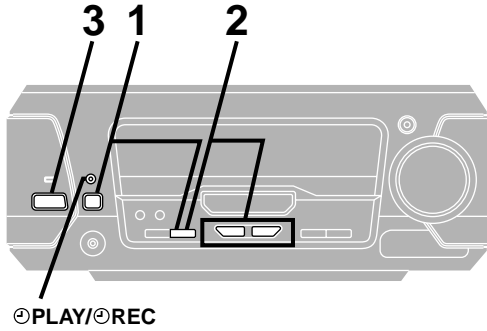
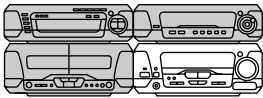

The record timer

This timer records the radio at the set time.

The displays in the illustrations show settings for recording preset channel 1 from 18:30 to 19:30.

Preparation: Turn the unit on, set the time (⇒ page 12), preset radio stations (⇒ page 28).

1 ① Press [CLOCK/TIMER] to display “⊙REC” on the tuner/amplifier.

Each time you press the button:
CLOCK→⊙PLAY→⊙REC→Original display

② Press [SET] within 3 seconds.

2 Follow these steps to set items (a), (b) and (c).

① Press [TUNING (∨ or ^)] to select the condition required and

② Press [SET].

- (a) Start time
- (b) Finish time
- (c) Preset channel

The record timer is now on standby. The display shows each condition again then restores the original display.

3 Prepare for recording.

- ① Insert a tape into deck 2.
- ② Select the Dolby NR mode.
- ③ Select the reverse mode.
- ④ Select the tape direction.

4 Press [⏻/⏷] to turn the unit off.

⊙PLAY/⊙REC indicator remains illuminated to show the record (or play) timer is on.

Recording starts 30 seconds before the set time with the volume muted during the set time.

To cancel the timer

Press [⊙PLAY/⊙REC] so “⊙REC” goes out.

Each time you press the button:

⊙PLAY→⊙REC→⊙PLAY ⊙REC→Light off

The record timer will be canceled, but the settings stay in the memory.

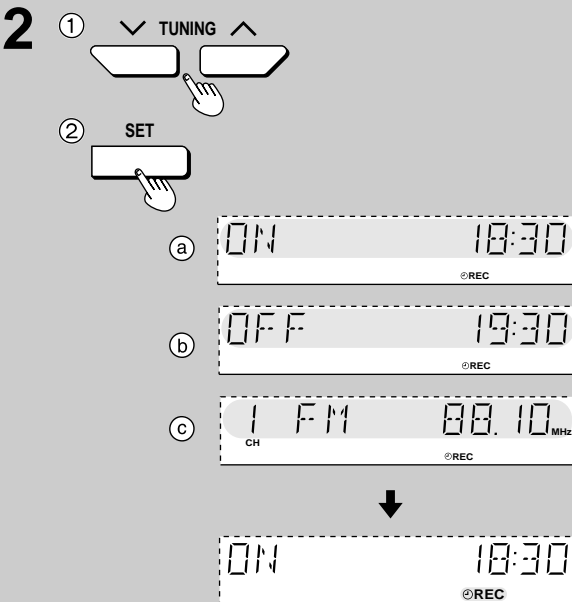
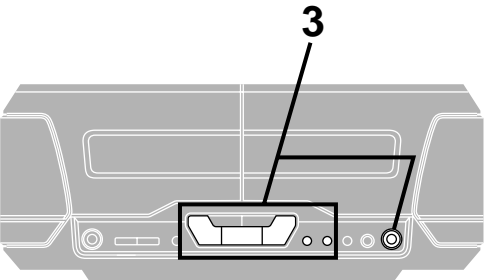
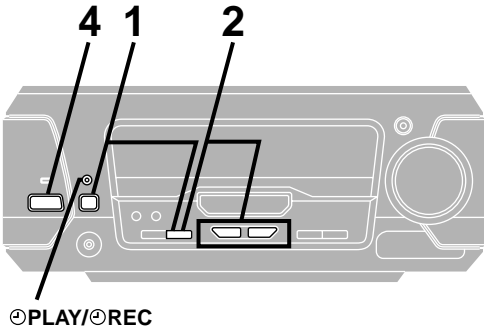
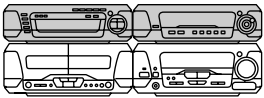

A

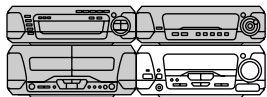

⊕PLAY/⊕REC

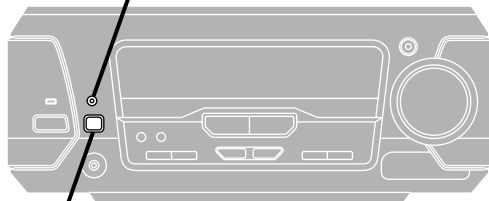

CLOCK/
TIMER

B

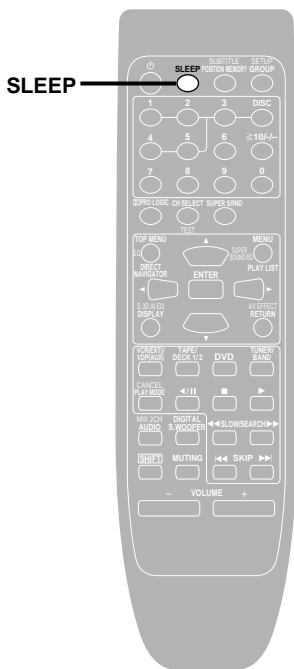

SLEEP

SLEEP

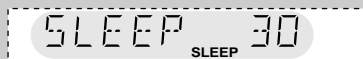

Using the timers

A The play and record timers

Turning the timers on and off

The timers come on at the set times if ⊕PLAY/⊕REC indicator is on. They can be turned on and off by pressing [⊕PLAY/⊕REC].

Checking the timers

Press [CLOCK/TIMER] to select "⊕PLAY" (or "⊕REC").

The timer conditions are shown in the following order:

Play timer:

Start time → Finish time → Source → Volume

Record timer:

Start time → Finish time → Selected radio station

The timers can be checked even if the unit is off.

Playing the unit after the timers are set

The unit can be used after the timers are set. Make sure the unit is off before the set start time.

Note

- If you turn the unit off and on again while a timer is functioning, the finish time setting will not be activated.
- If the unit is on, the timer will not function. The system must be in the standby mode.
- This system retains the ON/OFF time settings until you make a new setting. If you make a new ON time setting, you must make a new OFF time setting.
- Do not turn DEMO on after setting a timer. The timers will not work while DEMO is on.

B The sleep timer

Remote control only

This timer turns the unit off after a set time.

While playing a source

Press [SLEEP] to select the time (minutes).

Each time you press the button:

SLEEP 30 → SLEEP 60 → SLEEP 90
 ↑ SLEEP OFF ← SLEEP 120 ←

To cancel the sleep timer

Press [SLEEP] to select "SLEEP OFF".

"SLEEP" goes out.

To confirm the remaining time

(While the timer is functioning)

Press [SLEEP].

The remaining time is shown for about 5 seconds.

To change the setting

Press [SLEEP] to display the remaining time, then press again to select the required time.

Using the timers together

Any of the timers can be used together, but ensure the unit is off before the start time for the record and play timers.

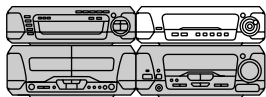
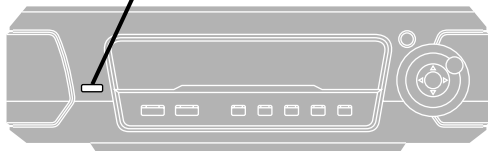
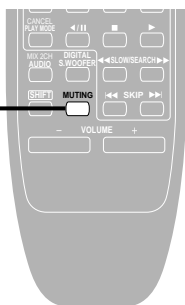
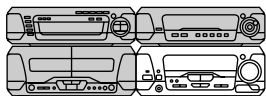
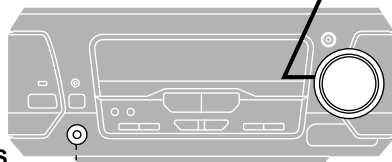
A**DISPLAY MODE****DISPLAY MODE****a****b****c****B****MUTING****MUTING****C****VOLUME****PHONES****A Changing the sound range display**

The sound processor shows the level of each sound range with the three types of display described below.

Press [DISPLAY MODE].

The spectrum display will change as follows.

[a] Normal display

This display indicates the strength of the sound in each tonal range.

[b] Peak-hold display

The peak sound value of each sound range is held on the display for about one second after it occurs.

[c] Aurora display

The peak sound value of each sound range is displayed in inverted form.

B Muting the volume**Remote control only****Press [MUTING].**

Volume is reduced to minimum.

To cancel

Press [MUTING] again.

"MUTING" goes out and the volume is restored.

To cancel from the tuner/amplifier, turn [VOLUME] to minimum (— dB), then raise it to the required level.

Muting is also canceled when the unit is turned off.

C Using headphones (not included)**Reduce the volume before connection.**

Avoid listening for prolonged periods of time to prevent hearing damage.

Plug type: 3.5 mm stereo

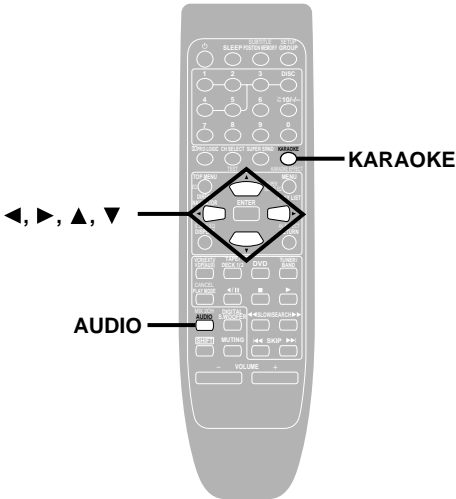
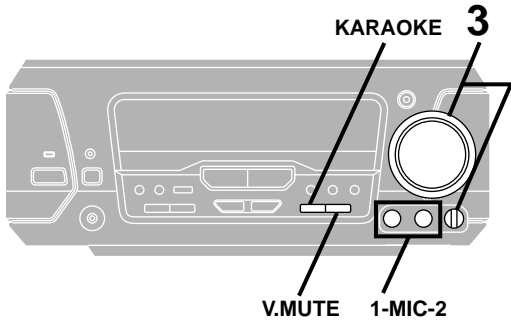
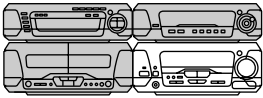

Preparation:

- Press [P/1] to turn the unit on.
- Turn on the television and switch the video input mode of the television to suit the type of connection you have made (e.g., VIDEO 1).
- Lower volume with [MIC VOL], then connect the microphone(s) to the microphone jack(s). (Plug type 6.3 mm monaural)

- 1 Start the source.**
- 2 Select the Karaoke mode.**
See below ([A], [B] or [C]) for operation details.
- 3 Adjust the main volume and microphone volume.**

A Karaoke DVD

Icons are displayed on the television to assist operation.

Remote control only

- ① Press [AUDIO].
- ② Press the cursor button [◀] or [▶] to select the vocal select mode.
- ③ Press [▲] or [▼] to select the appropriate mode.

(Refer to the discs jacket for details.)

The display on television changes each time you press the button:

- | | |
|----------------|---------------------|
| • Solo | • Duet |
| OFF: Vocal off | OFF: Vocal off |
| ON: Vocal on | V1+V2: Vocal 1+2 on |
| | V1: Vocal 1 on |
| | V2: Vocal 2 on |

Other sources (except for radio)

The changes in Karaoke mode are shown on the tuner/amplifier.

[B] Video CD/CD/cassette tape (multiplex)

Press [KARAOKE] to turn the vocals off.

MONO L: Vocal off (Lch only)

MONO R: Vocal on (Rch only)

(off): Karaoke mode canceled.

[C] DVD/Video CD/CD/cassette tape/video tape (non-Karaoke)

Press [V.MUTE] to turn the vocals off.

V.MUTE: Vocal off

(off): Karaoke mode canceled.

Note

- The Karaoke modes cannot be used with the radio, SUPER 3D AI EQ or surround effects.
- If a strange noise (squealing or howling) is emitted during use, move the microphone away from the speakers, or turn down the microphone volume.
When you are not using the microphone, disconnect it from the MIC jack, and turn down the microphone volume level to MIN.

When using the VOICE MUTE function

Voice mute may not function sufficiently or noise may interfere when using the following software.

- Monaural software
- Software with few musical instruments, including classical music and poetry recitations
- Software with duets or strong choruses

To record your performance

Start recording in deck 2 and then start singing.

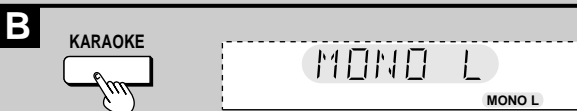
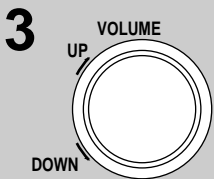

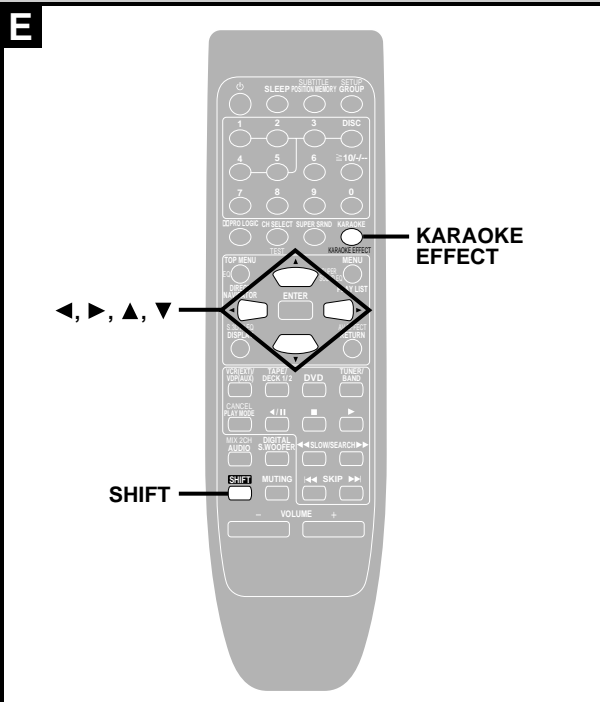
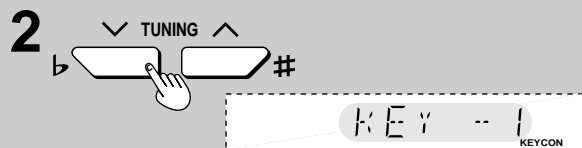
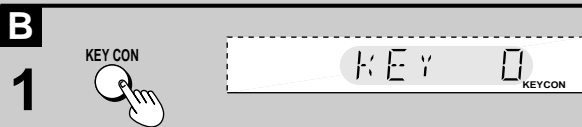
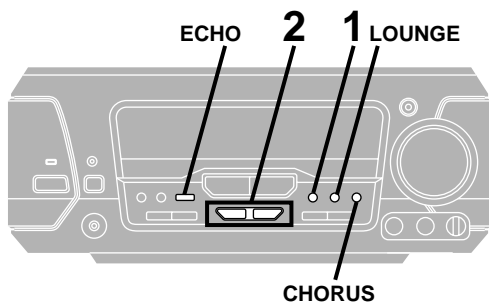
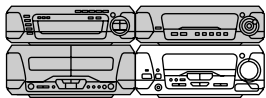

A Using the echo effect

Press [ECHO].

The display on the tuner/amplifier changes each time you press the button:

ECHO 1 → ECHO 2 → ECHO 3
 ↑ ECHO OFF ←

B Changing the key (up to 6 steps)

1 Press [KEY CON].

"KEY 0" is displayed on the tuner/amplifier.

2 Press [TUNING (b or #)] to change the key.

b: Lower the key by a half-tone (-1, -2, -3)

#: Raise the key by a half-tone (+1, +2, +3)

To restore the original key

Press [KEY CON] to display "KEY OFF" on the tuner/amplifier.

C Giving the effect of singing at a Karaoke bar

Disconnect headphones.

Press [LOUNGE].

The display on the tuner/amplifier changes each time you press the button:

LOUNGE 1 → LOUNGE 2 → LOUNGE 3
 ↑ LOUNGE OFF ←

To cancel the effect

Press [LOUNGE] to display "LOUNGE OFF" on the tuner/amplifier.

D Giving the effect of singing in a chorus

Press [CHORUS].

The display on the tuner/amplifier changes each time you press the button:

CHORUS 1 → CHORUS 2
 ↑ CHORUS OFF ←

To cancel the effect

Press [CHORUS] to display "CHORUS OFF" on the tuner/amplifier.

E Selecting the Karaoke effect with the remote control

① Press [SHIFT]+[KARAOKE EFFECT].

② Press [◀] or [▶] to select the desired effect.

ECHO ↔ KEY ↔ LOUNGE ↔ CHORUS
 ↑

③ Press [▲] or [▼] to select the desired level.

External unit connections

A

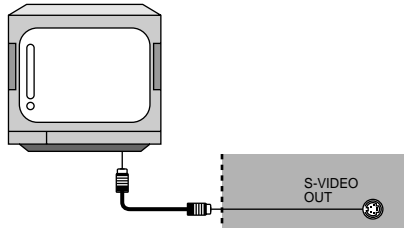

B

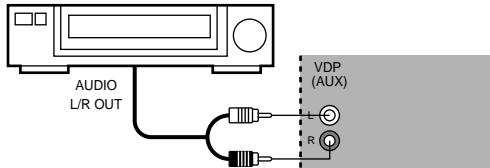

C

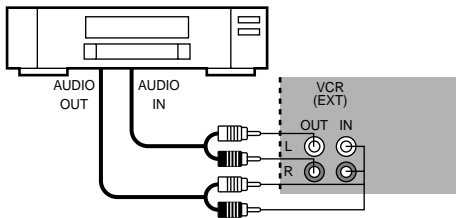

D

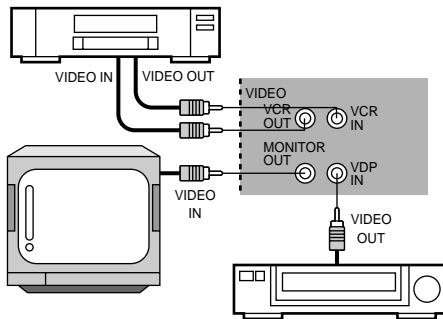

- Turn off all units before making connections.
- Refer to the manuals of the other units for details.
(Cords and equipment not included.)

S-video cord (not included)



Video cord

(1 included for the United Kingdom, Continental Europe and Russia

2 included for Australia and N.Z.)

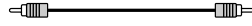

Stereo phono cable (not included)

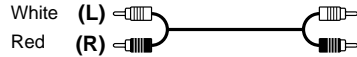

[A] Television with S-VIDEO terminal

The S-VIDEO output terminal on DVD/Video CD/CD changer achieves a more vivid picture than the video output terminal by separating the colour and luminance signals before transmitting them to the television. (Actual results depend on the television.)

[B] Laser Disc player (without 5.1ch output), etc.

Connect to the VDP (AUX) terminal on the sound processor.

This unit has Dolby Pro Logic circuitry. The sound will be reproduced with the same powerful stereophonic effects found in movie theaters.

[C] Video cassette recorder

Connect to the VCR (EXT) terminal on the sound processor.

You can play the sound from a video cassette recorder through this unit's speakers or record sound from this unit onto a video cassette.

[D] Television

(For Australia and N.Z.)

Using video cords, connect the following equipment to the terminals on the sound processor.

Connect a laser disc player or other audiovisual equipment to VDP IN.

Connect a television to MONITOR OUT.

Connect a video cassette recorder to VIDEO IN and VIDEO OUT.

These connections allow you to control the video and audio from this equipment with [INPUT SELECTOR].

Subwoofer

The included front speakers have subwoofers, but you can enhance the sound by connecting an optional subwoofer to SUBWOOFER OUT terminal on the back of the sound processor.

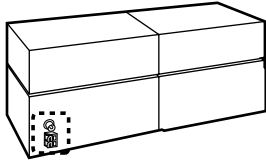
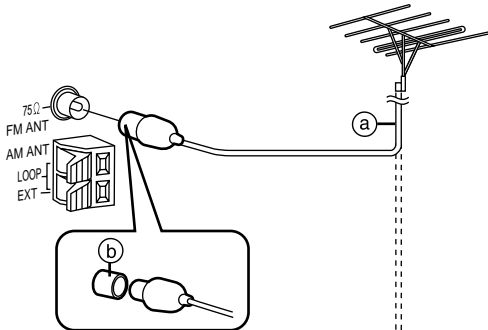
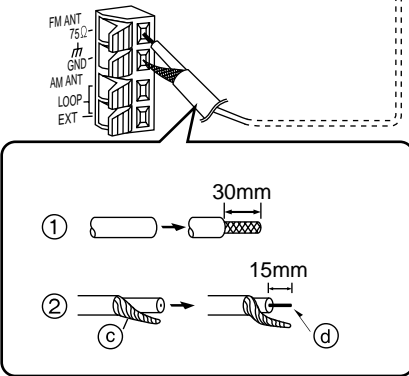
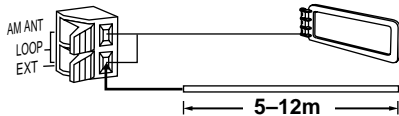
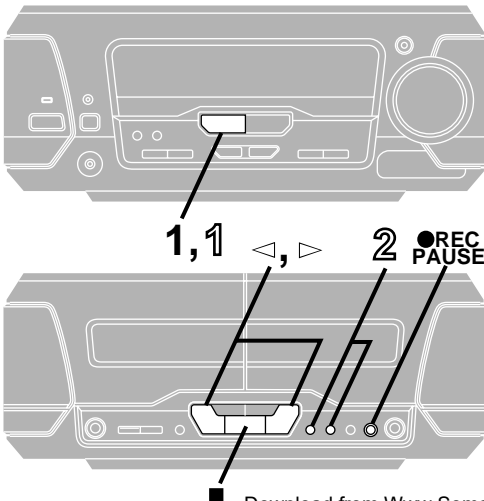
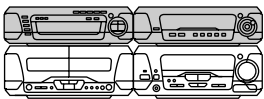
A**B****C****D****E**

Optional antenna connections

If radio reception is poor, connect outdoor antennas to the antenna terminals on the tuner/amplifier ([A]).

FM outdoor antenna

[B] For Continental Europe and Russia

Connect the 75 Ω coaxial cable (a) from the outdoor antenna to the FM antenna terminal.

For UK only

Attach the included antenna plug adaptor (b) to the end of the cable before connection.

[C] For Australia and N.Z.

After preparing the 75 Ω coaxial cable as described below, connect the shield braid (c) to GND and the core wire (d) to 75 Ω .

Preparing the 75 Ω coaxial cable

① Remove a piece of the outer vinyl.

② Twist the shield braid to expose the core wire.

• Disconnect the FM indoor antenna.

• The antenna should be installed by a competent technician.

D AM outdoor antenna

Use a piece of vinyl covered wire as an AM outdoor antenna. Connect it to AM ANT EXT and run it horizontally across a window or other convenient location.

Leave the loop antenna connected.

Note

Disconnect the antenna when the unit is not in use.

Do not use the antenna during an electrical storm.

E Using other equipment

Listening to an external source

1 Press [INPUT SELECTOR] to select the external source.

Each time you press the button:

TUNER \rightarrow DVD \rightarrow TAPE \rightarrow VCR (EXT) \rightarrow VDP (AUX)

On the remote control

Press [VCR (EXT)/VDP (AUX)].

2 Operate the unit.

See the unit's manual for details on operation and connection.

Recording an external source

1 Press [INPUT SELECTOR] to select the external source.

2 Select Dolby NR and reverse mode.

(\rightarrow page 35)

3 Press [● REC PAUSE].

4 Press [<] or [>] to start recording.

5 Start the source to be recorded.

See the unit's manual for details on operation and connection.

To stop recording

Press [■] on the deck.

To temporarily stop recording

Press [● REC PAUSE].

The deck goes into the recording standby mode.

To resume recording press [<] or [>] with the flashing indicator.





Recording onto an external unit

① Press [INPUT SELECTOR] to select the source to be recorded.

② Start recording on the external unit and start playing the source to be recorded.

Changing settings

This chart shows the settings for this unit. Change the settings to suit your preferences and to suit the unit to the environment in which it is being used. These settings are retained in memory until they are changed, even if the unit is turned off. See page 47 for details on menu operation.

Menus	Items	Options (Underlined items are the factory preset.)
Disc 	Audio Choose the preferred audio language.	<u>English</u> French German Italian Spanish Portuguese Swedish Dutch Original Other***** Original: The original language of each disc will be selected. Other*****: Input a code number with the numbered buttons (⇒ page 48).
	Subtitle Choose the preferred subtitle language.	<u>Automatic</u> English French German Italian Spanish Portuguese Swedish Dutch Other***** Automatic: If the language selected for "Audio" is not available, subtitles of that language will automatically appear if available on that disc.
	Menus Choose the preferred language for disc menus.	<u>English</u> French German Italian Spanish Portuguese Swedish Dutch Other*****
	Ratings (⇒ page 47) Set a ratings level to limit DVD-Video play. ● The password screen is shown if you choose levels 0 to 7 or if you choose "Ratings" when levels 0 to 7 have been selected. ● Select "Level 0" to prevent play of discs that do not have ratings levels recorded on them.	Setting ratings (When level 8 is selected) 8 <u>No Limit</u> : All DVD-Video can be played. 1 to 7: Prohibits play of DVD-Video with corresponding ratings recorded on them. 0 <u>Lock All</u> : Prohibits play of all DVD-Video. Changing ratings (When level 0–7 is selected) Unlock Player Change Password Change Level Temporary Unlock
Video 	TV Aspect (⇒ page 13) Choose the setting to suit your television and preference.	<u>4:3 Pan&Scan</u> 4:3 Letterbox 16:9
	TV Type (⇒ page 13) Select to suit the type of television.	<u>Standard (Direct View TV)</u> CRT Projector LCD TV/Projector Projection TV Plasma TV
	Still Mode Specify the type of picture shown when paused.	<u>Automatic</u> Field Frame
	NTSC Disc Output Choose whether PAL 60 or NTSC signals are output during playback of NTSC discs (⇒ page 5).	<u>PAL60</u> : when connected to a PAL television. NTSC: when connected to an NTSC television.
Audio 	Speaker Setting (⇒ page 47) Set the delay time for your center and surround speakers.	Multi-channel Center: 0/1.3/2.6/3.9/5.3 ms Surround (L/R): 0/5.3/10.6/15.9 ms
	Dynamic Range Compression (Dolby Digital only) Change the dynamic range for late night viewing.	<u>Off</u> On: For clear dialog when listening at low volume.
	Audio during Search Choose whether to have sound during search.	<u>On</u> Off ● This feature dose not work for some discs.
Display 	Menu Language Choose the preferred language for these menus and the on-screen messages.	<u>English</u> Français Deutsch Italiano Español Português Svenska Nederlands
	On-Screen Messages Choose whether to show on-screen messages or not.	<u>On</u> Off
Others 	Mixed Disc—Audio & Stills Select the type of file played on discs containing both JPEG and WMA/MP3. (Reload the disc for the setting to be effective.)	<u>Audio (MP3/WMA)</u> Stills (JPEG)
	DVD-Video Mode Select how to play pictures contained on some DVD-Audio. The setting returns to "Off" when you remove the disc, turn the unit off or change the source.	<u>Off</u> : DVD-Audio are played as DVD-Audio. On: DVD-Video contents found on DVD-Audio can be played.
	QUICK SETUP (⇒ page 13) Answer questions to make basic settings.	Yes <u>No</u>

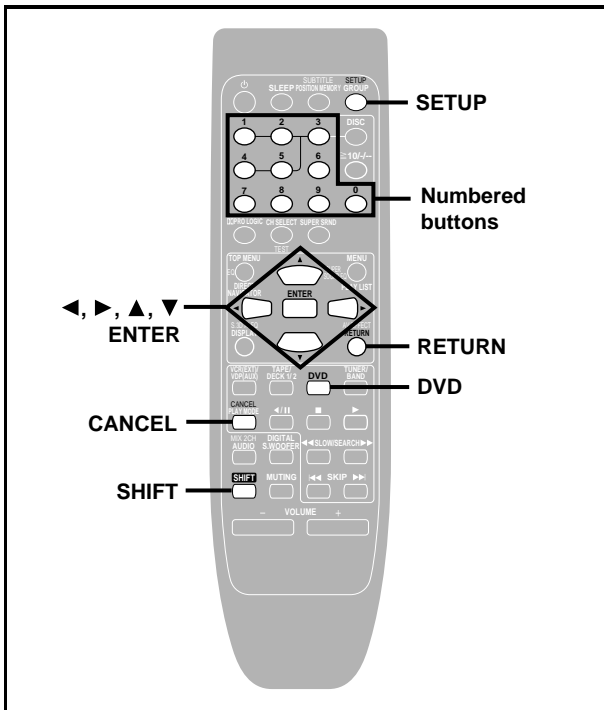

Entering a password (Ratings)

[DVD-V]

The password screen is shown when you select levels 0 to 7.

- Input a 4-digit password with the numbered buttons and press [ENTER].
 - If you enter a wrong number, press [SHIFT]+[CANCEL] to erase it before you press [ENTER].
 - The lock symbol appears closed to show the rating is locked.
 - Do not forget your password.**
- Press [ENTER] to confirm the 4 digits.

Now, when you insert a DVD-Video that exceeds the ratings limit you set, a message appears on the television. Follow the on-screen instructions.

Changing the delay time (Speaker Setting)

[DVD-V]

(Center and surround speakers only)

For optimum listening with 5.1-channel sound, all the speakers, except for the subwoofer, should be the same distance from the seating position. If you have to place the center or surround speakers closer to the seating position, adjust the delay time to make up for the difference.

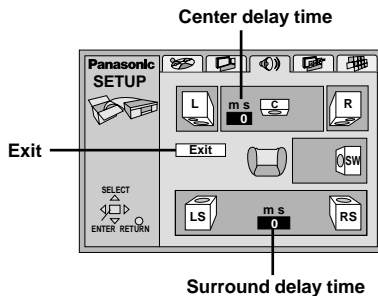

- Press [▲, ▼, ◀, ▶] to select the delay time box and press [ENTER].
- Press [▲, ▼] to adjust the delay time and press [ENTER].

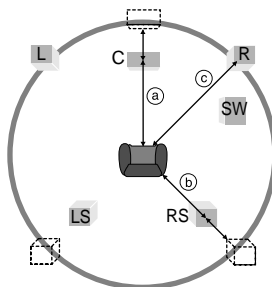

Values

If distance (a) or (b) is greater than or equal to distance (c), set to "0".
If distance (a) or (b) is less than distance (c), set as follows.

(a) Center speaker

Difference	Setting
Approx. 50 cm	1.3 ms
Approx. 100 cm	2.6 ms
Approx. 150 cm	3.9 ms
Approx. 200 cm	5.3 ms

(b) Surround speakers

Difference	Setting
Approx. 200 cm	5.3 ms
Approx. 400 cm	10.6 ms
Approx. 600 cm	15.9 ms

When you are finished

Press [▲, ▼, ◀, ▶] to select "Exit" and press [ENTER].

Common procedures

Remote control only

See page 46 for menu and option details.

Preparation: Press [DVD].

- Press [SHIFT]+[SETUP] to show the menus.

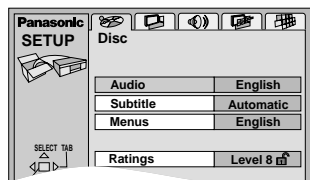

- Press [◀, ▶] to select the menu's tab.

The screen changes to display the menu.

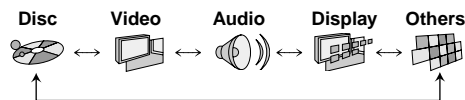

- Press [▲, ▼] to select the item you want to change and press [ENTER].

- Press [▲, ▼, ◀, ▶] to select the option and press [ENTER].

The screen now shows the menu again.

To return to the previous screen

Press [RETURN].

When you are finished

Press [SHIFT]+[SETUP].

Decoder

A decoder restores the coded audio signals on DVDs to normal. This is called decoding.

Dolby Digital

This is a method of coding digital signals developed by Dolby Laboratories. Apart from stereo (2-channel) audio, these signals can also be multi-channel audio. A large amount of audio information can be recorded on one disc using this method.

DTS (Digital Theater Systems)

This surround system is used in many movie theaters around the world. There is good separation between the channels, so realistic sound effects are possible.

Dynamic range

Dynamic range is the difference between the lowest level of sound that can be heard above the noise of the equipment and the highest level of sound before distortion occurs.

Frame still and field still

Frames are the still pictures that go together to make a moving picture. There are about 30 frames shown each second.

One frame is made up of two fields. A regular television shows these fields one after the other to create frames.

A still is shown when you pause a moving picture. A frame still is made up of two alternating fields, so the picture may appear blurred, but overall quality is high.

A field still is not blurred, but it has only half the information of a frame still so picture quality is lower.

I/P/B

MPEG 2, the video compression standard adopted for use with DVD-Video, codes frames using these 3 picture types.

I: Intra coded picture (I-picture)

This picture has the best quality and is the best to use when adjusting the picture.

P: Predictive coded picture (P-picture)

This picture is calculated based on past I or P-pictures.

B: Bidirectionally-predictive coded picture (B-picture)

This picture is calculated by comparing past and future I and P-pictures so it has the lowest volume of information.

Linear PCM (pulse code modulation)

These are uncompressed digital signals, similar to those found on CDs.

Playback control (PBC)

If a Video CD has playback control, you can select scenes and information with menus.

WMA/MP3/JPEG information

- Discs must conform to ISO9660 level 1 or 2 (except for extended formats).
- This unit is compatible with multi-session but if there are a lot of sessions it takes more time for play to start. Keep the number of sessions to a minimum to avoid this.

[WMA]

- Noise may occur when playing WMA files.
- You cannot play WMA files that are copy protected.
- WMA files must have the extension ".WMA" or ".wma".

[MP3]

- This unit is not compatible with ID3 tags.
- If you play an MP3 track that includes still picture data, it will take some time before the music itself starts playing and the elapsed time will not be displayed during this time. Even after the track starts, the correct play time will not be displayed.
- MP3 files must have the extension ".MP3" or ".mp3".

[JPEG]

To view JPEG files on this unit:

—Take them on a digital camera that meets the DCF (Design rule for Camera File system) standard. Some digital cameras have functions that are not supported by the DCF standard like automatic picture rotation which may render a picture un-viewable.

—Do not alter the files in any way or save them under a different name.

- Ensure they have the extension ".JPG" or ".jpg", ".JPEG" or ".jpeg".
- This unit cannot display moving pictures, MOTION JPEG and other such formats, still pictures other than JPEG (i.e. TIFF) or play associated sound.

Naming folders and files

At the time of recording, give folders and file names 3-digit prefixes in the order you want to play them (this may not work at times).

MPEG Layer-3 audio decoding technology licensed from Fraunhofer IIS and Thomson multimedia.

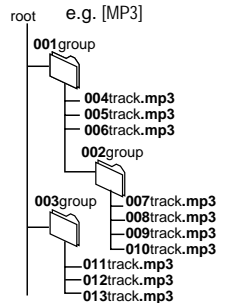

Windows Media, and the Windows logo are trademarks, or registered trademarks of Microsoft Corporation in the United States and/or other countries.



WMA is a compression format developed by Microsoft Corporation. It achieves the same sound quality as MP3 with a file size that is smaller than that of MP3.

Language code list

Abkhazian: 6566	Chinese: 9072	Hausa: 7265	Lithuanian: 7684	Romanian: 8279	Telugu: 8469
Afar: 6565	Corsican: 6779	Hebrew: 7387	Macedonian: 7775	Russian: 8285	Thai: 8472
Afrikaans: 6570	Croatian: 7282	Hindi: 7273	Malagasy: 7771	Samoan: 8377	Tibetan: 6679
Albanian: 8381	Czech: 6783	Hungarian: 7285	Malay: 7783	Sanskrit: 8365	Tigrinya: 8473
Ameharic: 6577	Danish: 6865	Icelandic: 7383	Malayalam: 7776	Scots Gaelic: 7168	Tonga: 8479
Arabic: 6582	Dutch: 7876	Indonesian: 7378	Maltese: 7784	Serbian: 8382	Turkish: 8482
Armenian: 7289	English: 6978	Interlingua: 7365	Maori: 7773	Serbo-Croatian: 8372	Turkmen: 8475
Assamese: 6583	Esperanto: 6979	Irish: 7165	Marathi: 7782	Shona: 8378	Twi: 8487
Aymara: 6588	Estonian: 6984	Italian: 7384	Moldavian: 7779	Sindhi: 8368	Ukrainian: 8575
Azerbaijani: 6590	Faroese: 7079	Japanese: 7465	Mongolian: 7778	Singhalese: 8373	Urdu: 8582
Bashkir: 6665	Fiji: 7074	Javanese: 7487	Nauru: 7865	Slovak: 8375	Uzbek: 8590
Basque: 6985	Finnish: 7073	Kannada: 7578	Nepali: 7869	Slovenian: 8376	Vietnamese: 8673
Bengali, Bangla: 6678	French: 7082	Kashmiri: 7583	Norwegian: 7879	Somali: 8379	Volapük: 8679
Bhutani: 6890	Frisian: 7089	Kazakh: 7575	Oriya: 7982	Spanish: 6983	Welsh: 6789
Bihari: 6672	Galician: 7176	Kirghiz: 7589	Pashto, Pushto: 8083	Sundanese: 8385	Wolof: 8779
Breton: 6682	Georgian: 7565	Korean: 7579	Persian: 7065	Swahili: 8387	Xhosa: 8872
Bulgarian: 6671	German: 6869	Kurdish: 7585	Polish: 8076	Swedish: 8386	Yiddish: 7473
Burmese: 7789	Greek: 6976	Laotian: 7679	Portuguese: 8084	Tagalog: 8476	Yoruba: 8979
Byelorussian: 6669	Greenlandic: 7576	Latin: 7665	Punjabi: 8065	Tajik: 8471	Zulu: 9085
Cambodian: 7577	Guarani: 7178	Latvian, Lettish: 7686	Quechua: 8185	Tamil: 8465	
Catalan: 6765	Gujarati: 7185	Lingala: 7678	Rhaeto-Romance: 8277	Tatar: 8484	

Technical specifications

SOUND PROCESSOR

■ EQ/SFP section	
MANUAL GEQ	
5-Band EQ	
Center frequency	70/300/1 k/3.15 k/10 k Hz
Level control	±2.0, 4.0, 6.0 dB
EQ/Space mode	
4 modes	HEAVY, CLEAR, SOFT, HALL
SUPER 3D AI EQ	
3 modes	AI EQ, SUPER 3D AI 1, SUPER 3D AI 2

■ Pre-amplifier section	
Input sensitivity/impedance	
VCR (EXT)	250 mV/15 kΩ
VDP (AUX)	250 mV/15 kΩ
Output level	
VCR REC OUT	150 mV/1.5 kΩ
(For Australia and N.Z.)	
VIDEO OUTPUT	
MONITOR OUT	1 Vp-p/75 Ω
VCR REC OUT	1 Vp-p/75 Ω

■ DOLBY PRO LOGIC section	
PRO LOGIC mode	
CENTER mode	SURROUND
DELAY TIME	NORMAL
	20 ms (Fixed)

■ AV SURROUND section	
AV surround mode	
	SUPER SURROUND(MUSIC, MOVIE)

■ DSP CONTROL section	
DSP control mode	
	SUPER SOUND EQ
	CENTER FOCUS
	VIRTUAL REAR SURROUND
	MULTI REAR SURROUND
	SEAT POSITION

■ Spectrum analyzer section	
Display mode	
	NORMAL, PEAKHOLD, AURORA
■ General	
Dimensions (W×H×D)	293×89×270 mm
Mass	1.5 kg

TUNER AMPLIFIER

■ Amplifier section	
Power output (L/R both channel driven)	
Stereo Mode	
DIN 1 kHz THD 1 %/6 Ω (High)	2×25 W
100 Hz THD 1 %/8 Ω (Low)	2×45 W
RMS 1 kHz THD 10 %/6 Ω (High)	2×35 W
100 Hz THD 10 %/8 Ω (Low)	2×65 W
PRO LOGIC mode	
DIN FRONT	
1 kHz THD 1 %/6 Ω (High)	2×25 W
100 Hz THD 1 %/8 Ω (Low)	2×45 W
SURROUND 1 kHz THD 1 %/8 Ω	2×30 W
CENTER 1 kHz THD 1 %/8 Ω	60 W
RMS FRONT	
1 kHz THD 10 %/6 Ω (High)	2×35 W
100 Hz THD 10 %/8 Ω (Low)	2×65 W
SURROUND 1 kHz THD 10 %/8 Ω	2×40 W
CENTER 1 kHz THD 10 %/8 Ω	80 W
PMPO 1 kHz/High 6 Ω, Low 8 Ω	
CENT. 8 Ω, SURR. 8 Ω	3000 W
Total harmonic distortion	
Rated power at 1 kHz	1 % (6 Ω)
Half power at 1 kHz	0.1 % (6 Ω)
Load impedance	
FRONT (High)	6 Ω
FRONT (Low)	8 Ω
SURROUND	8 Ω
CENTER	8 Ω
DIGITAL S. WOOFER	
Center frequency	60 Hz
LEVEL (VOL -20 dB)	MID +3 dB
	MAX +6 dB

■ FM tuner section	
Frequency range	
	87.50–108.00 MHz
	(0.05 MHz steps)
Sensitivity	
S/N 26 dB	1.8 μV (IHF usable)
S/N	1.5 μV
MONO	
Antenna terminal(s)	70 dB (75 dB, IHF)
	75 Ω (unbalanced)

■ AM tuner section	
Frequency range	
	522–1629 kHz (9 kHz steps)
	520–1630 kHz (10 kHz steps)
	500 μV/m
Sensitivity (S/N 20 dB)	
■ Timer section	
Clock	
	Quartz-lock type
Function	
	Play timer (1 time, daily),
	Rec timer (1 time, daily),
	Sleep (120 min, 30 min intervals)
Setting intervals (Play/Rec)	
	1 minute–23 hours 59 minutes
	(1 min intervals)

■ General	
Power supply	
(For the United Kingdom, Australia and N.Z.)	
	AC 230–240 V 50 Hz
(For Continental Europe and Russia)	
	AC 230 V 50 Hz
Power consumption	
	230 W
Standby	0.5 W
Dimensions (W×H×D)	
	293×118.5×345 mm
Mass	
	5.3 kg

DVD/VIDEO CD/CD CHANGER

■ Discs played (8 cm or 12 cm)	
	DVD-Video/DVD-Audio
	DVD-RAM/R (DVD-Video format discs)
	Video CD, CD (CD-DA)
	CD-R/RW (CD-DA/Video-CD,
	MP3/WMA/JPEG format discs)

■ Audio	
No. of channels	5.1 channel (FL, FR, SL, SR, C, SW)
■ Video	
Signal system	
	PAL 625/50, PAL 525/60, NTSC
Output level	
Composite video	1 Vp-p (75 Ω)
S-video Y	1 Vp-p (75 Ω)
S-video C	0.300 Vp-p (75 Ω) PAL
	0.286 Vp-p (75 Ω) NTSC

■ Pickup	
Beam source	Semiconductor laser
Wavelength	658/790 nm
(For Norge)	
Bølgelengde	658/790 nm
Laserstyrke	Ingen farlig stråling sendes ut
■ General	
Dimensions (W×H×D)	
	293×89×288 mm
Mass	
	2.5 kg

CASSETTE DECK

Deck system	
	Stereo cassette deck
Track system	
	4 track, 2 channel
Recording system	
	AC bias
Bias frequency	
	100 kHz
Erasing system	
	AC erase
Heads	
Deck 1	
(Playback head)	Permalloy head
Deck 2	
(Recording/Playback head)	Permalloy head
(Erasing head)	Double gap ferrite head
Motors	
Deck 1, 2	
Capstan drive	DC servo motor
Tape speed	4.8 cm/s
Wow and flutter	0.16 % (WRMS)

Fast forward and rewind times	
	Approx. 110 seconds with C-60 cassette tape
Frequency response (Dolby NR off)	
TYPE I (NORMAL)	20 Hz–16 kHz (DIN)
TYPE II (HIGH)	20 Hz–16 kHz (DIN)
TYPE IV (METAL)	20 Hz–16 kHz (DIN)
S/N (Signal level=max recording level, TYPE II type tape)	
NR off	56 dB (A weighted)
Dolby B NR on	66 dB (A weighted)
Input sensitivity and impedance	
REC (IN)	
	150 mV/23 kΩ
Output voltage and impedance	
PLAY (OUT)	
	280 mV/360 Ω

■ General	
Dimensions (W×H×D)	
	294×118.5×281 mm
Mass	
	2.1 kg

FRONT SPEAKER

Type	
	3 way, 3 speakers, Bassreflex
Speaker(s)	
Super woofer	17 cm cone type
Woofer	12 cm cone type
Tweeter	6 cm ring shaped dome type
Impedance	
	High 6 Ω
	Low 8 Ω
	High 60 W
	Low 120 W
Output sound pressure level	
	87 dB/W (1.0 m)
Crossover frequency	
	120 Hz, 4 kHz
Frequency range	
	42 Hz–50 kHz (–16 dB)
	46 Hz–36 kHz (–10 dB)

■ General	
Dimensions (W×H×D)	
	240×412×259 mm
Mass	
	5.8 kg

CENTER SPEAKER

Type	
	2 way, 3 speakers, Bassreflex
Speaker	
Woofer(×2)	8 cm cone type
Tweeter	6 cm cone type
Impedance	
	8 Ω
Input power (Music)	
	160 W
Output sound pressure level	
	86 dB/W (1.0 m)
Crossover frequency	
	4 kHz
Frequency range	
	100 Hz–22 kHz (–16 dB)
	115 Hz–20 kHz (–10 dB)

■ General	
Dimensions (W×H×D)	
	190×99×166 mm
Mass	
	1.8 kg

SURROUND SPEAKER

Type	
	1 way, 1 speaker, Closed
Speaker	
Full range	8 cm cone type
Impedance	
	8 Ω
Input power (Music)	
	70 W
Output sound pressure level	
	84 dB/W (1.0 m)
Frequency range	
	130 Hz–20 kHz (–16 dB)
	150 Hz–18 kHz (–10 dB)

■ General	
Dimensions (W×H×D)	
	140×99×118 mm
Mass	
	0.9 kg

※“Low” and “High” stand for low frequency and high frequency.

Note

- Specifications are subject to change without notice. Mass and dimensions are approximate.
- Total harmonic distortion is measured by the digital spectrum analyzer.

This product incorporates copyright protection technology that is protected by method claims of certain U.S. patents and other intellectual property rights owned by Macrovision Corporation and other rights owners. Use of this copyright protection technology must be authorized by Macrovision Corporation, and is intended for home and other limited viewing uses only unless otherwise authorized by Macrovision Corporation. Reverse engineering or disassembly is prohibited.

Troubleshooting guide

Before requesting service, make the below checks. If you are in doubt about some of the check points, or if the remedies indicated in the chart do not solve the problem, consult your dealer for instructions.

Reference pages are shown as black circled numbers ⑦.

Common Problems

No sound.	Turn the volume up. Switch off the unit, determine and correct the cause, then switch the unit on. Causes include shorting of the positive and negative speaker wires, straining of the speakers through excessive volume or power, and using the unit in a hot environment.
Sounds unfixed, reversed or come from one speaker only.	Check the speaker connections. ⑦
Humming heard during play.	An AC mains lead or fluorescent light is near the cables. Keep other appliances and leads away from this unit's cables. If possible in your area, turn the AC mains lead's plug or connector over to reverse the lead's polarity.
"ERROR" is displayed.	Incorrect operation performed. Read the instructions and try again.
"U70" is displayed.	Connect the flat cables firmly. If "U70" remains on the display, contact the dealer.
"F61" is displayed.	There is a problem with the amplifier. Consult your dealer.
"---:---" appears on the display.	You plugged the AC mains lead in for the first time or there was a power failure recently. Set the time. ⑫
The display starts up even after the unit is turned off.	The demonstration feature (-DEMO) is on. Turn it off if it is not required. ①
"DVD U11" displayed.	The disc is dirty. Wipe it with a soft cloth. ⑤
"DVD H □□" displayed. (□□ will be numbers.)	A problem has occurred. Turn the unit off and unplug the AC mains lead. Wait a moment and then plug the lead in and turn on the unit again. If the unit is still not working correctly, consult your dealer.
Initial settings menu cannot be accessed.	Select "DVD" as the source. Cancel all group, program, random and ALL DISC play. ⑯-⑳

Listening to the radio

Noise is heard. The stereo indicator flickers or doesn't light. Sound is distorted.	Use an outdoor antenna. ④⑤
A beat sound is heard.	Turn the TV off or separate it from the unit.
A low hum is heard during AM broadcasts.	Separate the antenna from other cables and leads.
The correct AM frequency can't be tuned in.	Change the frequency step. Hold [TUNER/BAND] down for 10 seconds to change the step to 9 kHz.

Listening to tapes

Poor quality sound.	Clean the heads. ③ Check the Dolby NR setting. ⑳
Recording is not possible.	If the erasure prevention tabs have been removed, cover the holes with adhesive tape. ③⑤

Enjoying discs

Sound is distorted.	When you are playing a DVD recorded with Dolby Digital, you can reduce distortion by compressing the dynamic range. See Audio-Dynamic Range Compression in the SETUP menus. ④⑥
"NO DISC" appears on display	There is no disc on the selected tray or the disc is set incorrectly.
"NO PLAY" appears on display	The disc does not correspond to the unit and cannot be played. ⑤
Play doesn't start (or stops immediately) when you press [▶] (play).	<ul style="list-style-type: none"> ●Condensation has formed: Wait 1 to 2 hours for it to evaporate. ●This unit cannot play discs other than the ones listed in these operating instructions. ⑤ ●You can only play DVD-Video if their region number is the same or includes the same region number as the unit or if the DVD-Video is marked "ALL". Confirm the region number for the unit on the rear panel. ① ●The disc may be dirty and may require cleaning. ⑤ ●Ensure that the disc is installed with the label of the side to be played facing upwards. ④ ●Check that the DVD-RAM has something recorded on it.

Enjoying discs

“TAKE OUT/DISC” appears on display.	There is a problem with the disc mechanism. (A power failure may have occurred.) The tray will open automatically. Remove the disc from the tray, and close it after ensuring there is no disc in the tray. The unit will make disc changing noises for a few moments and then it should operate normally.
No picture.	<ul style="list-style-type: none"> ● Check the connection. 9 ● Make sure the television is on. ● Ensure the television's video input setting (e.g., VIDEO 1) is correct.
The picture shown on the television is not normal. (The sides of the picture are cut off, the picture is stretched horizontally or black bands appear at the top and bottom of the screen.)	<ul style="list-style-type: none"> ● Go to Video in the SETUP menus, and change “TV Aspect” to suit your television. 46 ● Use the television to change the aspect to the correct one. ● Ensure that the unit is connected directly to the television, and is not connected through a video cassette recorder. ● Change the size with the variable zoom function. 18
Menus not displayed correctly.	<ul style="list-style-type: none"> ● Change the zoom ratio to “×1.00”. 18 ● With the GUI screen, change “Subtitle Position” to “0”. 26
Picture on TV screen disappears or stripes appear on screen.	The location and orientation of the antenna are incorrect. If you are using an indoor antenna, change to an outdoor antenna. 45 The television antenna wire is too close to the system. Separate the antenna wire of the television from the system.
The position of the subtitles is incorrect.	Change the position of the subtitles with “Subtitle Position” in the GUI screen. 26
Cannot add markers.	You cannot add markers while playing a play list or if the disc's play time doesn't appear on the unit's display.
There are already markers. [RAM]	The unit reads and displays the markers added with a DVD video recorder. You can clear them but reappear when you turn the unit off, change the source, open the disc tray or change the disc.
Marker numbers I added are different when I call them up. [RAM]	The unit numbers markers by time so they change when you add and delete them.
Folders deeper than the eighth layer on a data CD are not displayed correctly.	Folders deeper than the eighth layer are displayed as the eighth layer.
You have forgotten your ratings password. (Reset all the settings to Factory Preset)	Reset the unit to its original factory settings by doing the following procedure. When “DVD” is selected as a source, press [■] on the changer and [≧10/-/-] on the remote control at the same time for about 3 seconds until the message “Initialized” disappears from the television screen.
Cannot eject disc.	The unit may not operate properly if the disc is damaged or dirty. Press [⏏/I] and after the display disappears, wait a few seconds, then press [⏏/I] again and eject the disc.

During one touch disc editing (⇒ page 36)

“DECK NO TAPE” displayed.	Load a cassette into deck 2. 65
“DECK CHANGE TAPE” displayed.	If the erasure prevention tabs have been removed, cover the holes with adhesive tape. 65

The remote control

The remote control doesn't work.	Check the batteries are inserted correctly. 12 Replace the batteries if they are worn.
---	--

All components are required to service the system. If service is ever necessary, bring the entire system.

CAUTION!

THIS PRODUCT UTILIZES A LASER.
USE OF CONTROLS OR ADJUSTMENTS OR PERFORMANCE OF PROCEDURES OTHER THAN THOSE SPECIFIED HEREIN MAY RESULT IN HAZARDOUS RADIATION EXPOSURE.
DO NOT OPEN COVERS AND DO NOT REPAIR YOURSELF. REFER SERVICING TO QUALIFIED PERSONNEL.

WARNING:

TO REDUCE THE RISK OF FIRE, ELECTRIC SHOCK OR PRODUCT DAMAGE, DO NOT EXPOSE THIS APPARATUS TO RAIN, MOISTURE, DRIPPING OR SPLASHING AND THAT NO OBJECTS FILLED WITH LIQUIDS, SUCH AS VASES, SHALL BE PLACED ON THE APPARATUS.

CAUTION!

- DO NOT INSTALL OR PLACE THIS UNIT IN A BOOKCASE, BUILT-IN CABINET OR IN ANOTHER CONFINED SPACE. ENSURE THE UNIT IS WELL VENTILATED. TO PREVENT RISK OF ELECTRIC SHOCK OR FIRE HAZARD DUE TO OVERHEATING, ENSURE THAT CURTAINS AND ANY OTHER MATERIALS DO NOT OBSTRUCT THE VENTILATION VENTS.
- DO NOT OBSTRUCT THE UNIT'S VENTILATION OPENINGS WITH NEWSPAPERS, TABLECLOTHS, CURTAINS, AND SIMILAR ITEMS.
- DO NOT PLACE SOURCES OF NAKED FLAMES, SUCH AS LIGHTED CANDLES, ON THE UNIT.
- DISPOSE OF BATTERIES IN AN ENVIRONMENTALLY FRIENDLY MANNER.

This product may receive radio interference caused by mobile telephones during use. If such interference is apparent, please increase separation between the product and the mobile telephone.

THIS UNIT IS INTENDED FOR USE IN MODERATE CLIMATES.

SUOMI

VAROITUS!

LAITTEEN KÄYTTÄMINEN MUULLA KUIN TÄSSÄ KÄYTTÖOHJEESSA MAINITULLA TAVALLA SAATTAÄ ALTISTAA KÄYTTÄJÄÄN TURVALLISUUSLUOKAN 1 YLITTÄVÄLLE NÄKYMÄTTÖMÄLLE LASERSÄTEILYLLE.

VAROITUS:

TULIPALO-, SÄHKÖISKUKVAARAN TAI TUOTETTA KOHTAAVAN MUUN VAHINGON VÄHENTÄMISEKSI EI LAITETTA SAA ALTISTAA SATEELLE, KOSTEUELLE, VESIPISAROILLE TAI ROISKEELLE, EIKÄ NESTETTÄ SISÄLTÄVIÄ ESINEITÄ, KUTEN ESIMERKIKSI MALJAKOITA, SAA ASETTAA LAITTEEN PÄÄLLE.

VAROITUS!

- ÄLÄ ASENNATA TAI LAITA TÄTÄ LAITETTA KABINETTITYYPPISEEN KIRJAKAAPPIIN TAI MUUHUN SULJETTUUN TILAAN, JOTTA TUULETUS ONNISTUISI. VARMISTA, ETTÄ VERHO TAI MIKÄÄN MUU MATERIAALI EI HUONONNA TUULETUSTA, JOTTA VÄLTETTÄISIIN YLIKUMENEMISESTA JOHTUVA SÄHKÖISKU- TAI TULIPALOVAARA.
- ÄLÄ PEITÄ LAITTEEN TUULETUSAUKKOJA SANOMALEHDellä, PÖYTÄLAINALLA, VERHOLLA TAI MUULLA VASTAAVALLA ESINEELLÄ.
- ÄLÄ ASETA PALAVAA KYNTILÄÄ TAI MUUTA AVOTULEN LÄHDETTÄ LAITTEEN PÄÄLLE.
- HÄVITÄ PARISTOT LUONTOA VAHINGOITAMATTOMALLA TAVALLA.

TÄMÄ LAITE ON TARKOITETTU KÄYTETTÄVÄKSI LEUDOSSA ILMASTOSSA.

NORSK

ADVARSEL!

DETTE PRODUKTET ANVENDER EN LASER.
BETJENING AV KONTROLLER, JUSTERINGER ELLER ANDRE INNGREP ENN DE SOM ER BESKREVET I DENNE BRUKSANVISNING, KAN FØRE TIL FARLIG BESTRÅLING.
DEKSLER MÅ IKKE ÅPNES, OG FORSØK ALDRI Å REPARERE APPARATET PÅ EGENHÅND. ALT SERVICE OG REPARASJONSARBEID MÅ UTFØRES AV KVALIFISERT PERSONELL.

ADVARSEL:

FOR Å REDUSERE FAREN FOR BRANN, ELEKTRISK STØT ELLER SKADER PÅ PRODUKTET, MÅ DETTE APPARATET IKKE UTSETTES FOR REGN, FUKTIGHET, VANNDRÅPER ELLER VANNSPRUT. DET MÅ HELLER IKKE Plasseres GJENSTANDER FYLT MED VANN, SLIK SOM BLOMSTERVASER, OPPÅ APPARATET.

ADVARSEL!

- APPARATET MÅ IKKE Plasseres I EN BOKHYLLE, ET INNEBYGGET KABINETT ELLER ET ANNET LUKKET STED HVOR VENTILASJONSFORHOLDENE ER UTILSTREKKELIGE. SØRG FOR AT GARDINER ELLER LIGNENDE IKKE FORVERRER VENTILASJONSFORHOLDENE, SÅ RISIKO FOR ELEKTRISK SJOKK ELLER BRANN FORÅRSAKET AV OVERHETING UNNGÅS.
- APPARATETS VENTILASJONSÅPNINGER MÅ IKKE DEKkes TIL MED AVISER, BORDDUKER, GARDINER OG LIGNENDE.
- Plasser IKKE ÅPEN ILD, SLIK SOM LEVENDE LYS, OPPÅ APPARATET.
- BRUKTE BATTERIER MÅ KASSERES UTEN FARE FOR MILJØET.

DETTE APPARATET ER BEREGNET TIL BRUK UNDER MODERATE KLIMAFORHOLD.



LUOKAN 1 LASERLAITE KLASS 1 LASER APPARAT

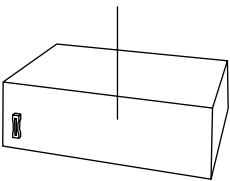

DVD/Video CD/CD Changer
(Back of product)

DANGER	- VISIBLE AND INVISIBLE LASER RADIATION WHEN OPEN. AVOID DIRECT EXPOSURE TO BEAM. (FDA 21 CFR)
CAUTION	- VISIBLE AND INVISIBLE LASER RADIATION WHEN OPEN. AVOID EXPOSURE TO BEAM. (IEC60825-1)
ATTENTION	- RAYONNEMENT LASER VISIBLE ET INVISIBLE EN CAS D'OUVERTURE. EXPOSITION DANGEREUSE AU FAISCEAU.
ADVARSEL	- SYNLIG OG USYNLIG LASERSTRÅLING VED ÅBNING. UNDGÅ UDSÆTTELSE FOR STRÅLING.
VARO!	- AVATTAESSA OLET ALTTIINÄ NÄKYYVÄÄ JA NÄKYMÄTÖN LASERSÄTEILYLLE. ÄLÄ KATSO SÄTEESEEN.
WARNING	- SYNLIG OCH OSYNLIG LASERSTRÅLING NÄR DENNA DEL ÄR ÖPPNAD. BETRÄKTA EJ STRÅLEN.
ADVARSEL	- SYNLIG OG OSYNLIG LASERSTRÅLING NÄR DEKSEL ÅPNES. UNNGÅ EKSPONERING FOR STRÅLEN.
VORSICHT	- SICHTBARE UND UNSICHTBARE LASERSTRÄHLUNG, WENN ABDECKUNG GEÖFFNET. NICHT DEM STRAHL AUSSETZEN.
注意	- 打开时有可见及不可见激光辐射。避免激光束照射。
注意	- ここを開くと可視及び不可視のレーザー光が出ます。 ビームを直接に、照射してはなりません。

(Inside of product)
(Tuotteen sisällä)
(Produktets insidde)

Matsushita Electric Industrial Co., Ltd.
Web Site: <http://www.panasonic.co.jp/global/>

En

RQT6894-B
F0203AT0

Free Manuals Download Website

<http://myh66.com>

<http://usermanuals.us>

<http://www.somanuals.com>

<http://www.4manuals.cc>

<http://www.manual-lib.com>

<http://www.404manual.com>

<http://www.luxmanual.com>

<http://aubethermostatmanual.com>

Golf course search by state

<http://golfingnear.com>

Email search by domain

<http://emailbydomain.com>

Auto manuals search

<http://auto.somanuals.com>

TV manuals search

<http://tv.somanuals.com>