

System Component

SC-EH600

SC-EH500

Operating Instructions

Technics®

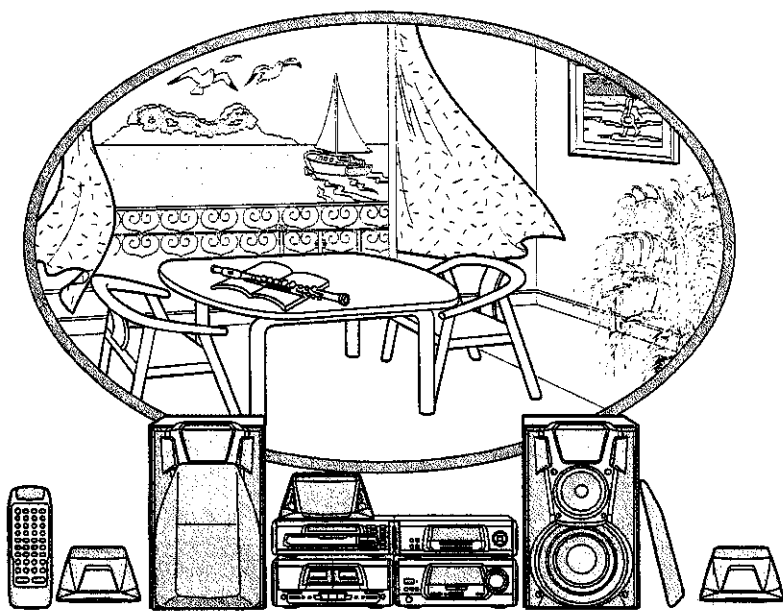

The illustrations show SC-EH600 for United Kingdom.

Note:

The "EB" indication shown on the outside packing case indicates United Kingdom.

Before connecting, operating or adjusting this product, please read these instructions completely. Please save this manual.

EB EP GN

COMPACT
disc
DIGITAL AUDIO

Dear customer

Thank you for purchasing this system.
 For optimum performance and safety, please read these instructions carefully.
 These operating instructions are applicable to the following systems.
 These operating instructions, however, fundamentally explain the operation of system SC-EH600.

System	SC-EH600	SC-EH500
Sound processor	SH-EH600	SH-EH500
Tuner/amplifier	SA-EH600	SA-EH500
CD changer	SL-EH600	—
CD player	—	SL-EH500
Cassette deck	RS-EH600	RS-EH600
Speakers	Front	SB-EH600
	Center	SB-PC600
	Surround	SB-PS600

CAUTION!

THIS PRODUCT UTILIZES A LASER.
USE OF CONTROLS OR ADJUSTMENTS OR PERFORMANCE OF PROCEDURES OTHER THAN THOSE SPECIFIED HEREIN MAY RESULT IN HAZARDOUS RADIATION EXPOSURE.
DO NOT OPEN COVERS AND DO NOT REPAIR YOURSELF. REFER SERVICING TO QUALIFIED PERSONNEL.

CAUTION!

DO NOT INSTALL OR PLACE THIS UNIT IN A BOOKCASE, BUILT IN CABINET OR IN ANOTHER CONFINED SPACE IN ORDER TO KEEP WELL VENTILATED CONDITION. ENSURE THAT CURTAINS AND ANY OTHER MATERIALS DO NOT OBSTRUCT THE VENTILATION CONDITION TO PREVENT RISK OF ELECTRIC SHOCK OR FIRE HAZARD DUE TO OVERHEATING.



(Back of product)

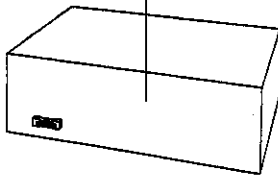

CD changer or CD player

DANGER	INVISIBLE LASER RADIATION WHEN OPEN. AVOID DIRECT EXPOSURE TO BEAM.	(Inside of product)
ADVARSEL	USYRLIG LASERSTRÅLING VED ÅBNING. UNDRSKUEMØDIGHEDSBRYDERE ER UDE AF FUNKTION. UDSIKTSRISIKO FOR STRÅLING.	(Indersiden af apparatet)
VARO!	AVATTIÄSSÄ JÄ SUOJALUKITUS OHIETÄÄSSÄ OLET ALTIIN HÄRMIÄTÖNTÄ LASERSÄTELYLLE. ÄLÄ KÄTSÖ SÄTÄESSÄ.	(Tuotteen sisällä)
WARNING	OSYRLIG LASERSTRÅLING NÄR DENNA DEL ÄR ÖPPNAD OCH SPÄRRETT ÄR URKOPPLAD. BETRÄKTA EJ STRÅLEN!	(Apparatens insida)
ADVARSEL	USYRLIG LASERSTRÅLING NÄR DENDEL ER ÖPPNAD OCH SPÄRRET ER SPERRING FOR STRÅLEN!	(Produktets innside)
VORSICHT	UNSICHTBARE LASERSTRÄHLUNG. VERBODEN TOEGANG GEOPFLOT. NICHT DENN STRAHL AUSSETZEN!	(im Inneren des Gerätes)

(For Australia and N.Z.)

THIS MUSIC SYSTEM IS CAPABLE OF RECEIVING THE NEW AM STEREO BROADCASTS FROM THE AM BAND RADIO STATIONS. HOWEVER LIKE MANY MUSIC SYSTEM CURRENTLY AVAILABLE ON THE MARKET IT WILL REPRODUCE THIS AM STEREO SIGNAL ONLY IN AM MONO, WHICH, IN EFFECT, IS OF NO LESSER QUALITY THAN YOUR EXISTING AM MONO MUSIC SYSTEM.

Supplied accessories



Please check and identify the supplied accessories.

- AC power supply cord 1 pc.
 For United Kingdom (VJA0733) For Australia and N.Z. (RJA0035-X)

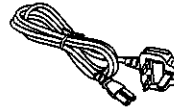

For others (RJA0019-X)



- Remote control transmitter 1 pc.
 SC-EH600 (RAK-CH219WH) SC-EH500 (RAK-CH426WH)



- Remote control batteries 2 pcs.

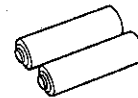

- FM indoor antenna 1 pc.
 For Australia and N.Z. (RSA0006) For others (RSA0007)

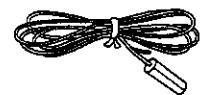

- AM loop antenna set (RSA0022-J) 1 pc.
 • AM loop antenna 1 pc.
 • Antenna holder (RMN0244) 1 pc.

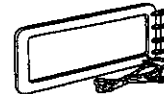

- Speaker cords 4 pcs.
 SC-EH600 (REE0393) (REE0853) SC-EH500 (REE0499) (REE0853)



- Antenna plug adaptor (SJP9009) 1 pc.
 (United Kingdom only)



Use numbers indicated in parentheses when asking for replacement

Table of contents

Before use

Caution for AC mains lead	4
Preparing for the remote control	5
Installation	5
Connections	6
Speaker caution	7
Front panel controls	10
Setting the time	12
Memory presetting	13
Automatic memory presetting	13
Manual memory presetting	14

Radio operations

Listening to radio broadcasts	15
Enjoying RDS broadcasts (For areas except UK, Australia and N.Z.)	16
Types of RDS and functions	16
To display the name of a broadcasting station	16
To display the type of a program	16
About the PTY display	17

Compact disc operations

Listening to compact discs For SC-EH600	18
How to load CDs	18
How to check which trays have discs	18
Sequential play	19
Direct access play	20
Repeat play	20
Random play	20
Program play	21
Listening to compact discs For SC-EH500	22
Sequential play	22
Direct access play	23
Repeat play	23
Random play	23
Program play	24

Cassette deck operations

Listening to tapes	25
Playback	25
To reset the tape counter	26
To fast forward or rewind the tape	26
To find the beginning of a program (TPS: tape program sensor)	27
Sequential playback among 2 tapes	27

Sound field/tone quality operations/ other functions

Changing the tone	28
Boosting the super woofer	28
Using the internal sound quality	28
Using the acoustic image EQ	29
Finer sound quality changes	29
Concerning the display	30
To mute the volume	30
Enjoying sound with DOLBY PRO LOGIC For SC-EH600	31
SURROUND	31
3 STEREO	31
Setting the center mode	31
Adjusting speaker output level	32
Enjoying SURROUND or 3 STEREO	33

Recording operations

Before recording	34
Type of tapes which can be recorded	34
How to advance the leader tape	34
About Dolby noise-reduction system	34
To erase recorded sounds	34
Recording from radio broadcasts	35
Recording from compact discs For SC-EH600	36
Normal recording	37
One-touch editing	38
Recording onto left over space on tapes (LINK)	39
Recording from compact discs For SC-EH500	40
Normal recording	41
One-touch editing	42
Recording onto left over space on tapes (LINK)	43
Tape-to-tape recording	44

Enjoying KARAOKE

Singing along with KARAOKE (For Australia and N.Z. only)	45
--	----

Timer operations

Using the timer	47
Setting the play timer	47
Setting the record timer	49
To use the sleep timer	50
To use each timer mode in conjunction	51

Reference

Using an external unit	52
Remote control buttons and functions For SC-EH600	53
Remote control buttons and functions For SC-EH500	54
Suggestions for safety	55
Concerning compact discs	56
Concerning cassette tapes	56
Technical specifications	57
Troubleshooting guide	58
Maintenance	59

Caution for AC mains lead

(For United Kingdom)

("EB" area code model only)

For your safety, please read the following text carefully.

This appliance is supplied with a moulded three pin mains plug for your safety and convenience. A 5-ampere fuse is fitted in this plug.

Should the fuse need to be replaced please ensure that the replacement fuse has a rating of 5-ampere and that it is approved by ASTA or BSI to BS1362.

Check for the ASTA mark  or the BSI mark  on the body of the fuse.

If the plug contains a removable fuse cover you must ensure that it is refitted when the fuse is replaced.

If you lose the fuse cover the plug must not be used until a replacement cover is obtained.

A replacement fuse cover can be purchased from your local dealer.

CAUTION!

IF THE FITTED MOULDED PLUG IS UNSUITABLE FOR THE SOCKET OUTLET IN YOUR HOME THEN THE FUSE SHOULD BE REMOVED AND THE PLUG CUT OFF AND DISPOSED OF SAFELY.

THERE IS A DANGER OF SEVERE ELECTRICAL SHOCK IF THE CUT OFF PLUG IS INSERTED INTO ANY 13-AMPERE SOCKET.

If a new plug is to be fitted please observe the wiring code as shown below.

If in any doubt please consult a qualified electrician.

IMPORTANT

The wires in this mains lead are coloured in accordance with the following code:

Blue: Neutral, Brown: Live.

As these colours may not correspond with the coloured markings identifying the terminals in your plug, proceed as follows:

The wire which is coloured Blue must be connected to the terminal which is marked with the letter N or coloured Black or Blue.

The wire which is coloured Brown must be connected to the terminal which is marked with the letter L or coloured Brown or Red.

WARNING: DO NOT CONNECT EITHER WIRE TO THE EARTH TERMINAL WHICH IS MARKED WITH THE LETTER E, BY THE EARTH SYMBOL \perp OR COLOURED GREEN OR GREEN/YELLOW.

THIS PLUG IS NOT WATERPROOF—KEEP DRY.

Before use

Remove the connector cover.

How to replace the fuse

The location of the fuse differ according to the type of AC mains plug (figures A and B). Confirm the AC mains plug fitted and follow the instructions below. Illustrations may differ from actual AC mains plug.

1. Open the fuse cover with a screwdriver.

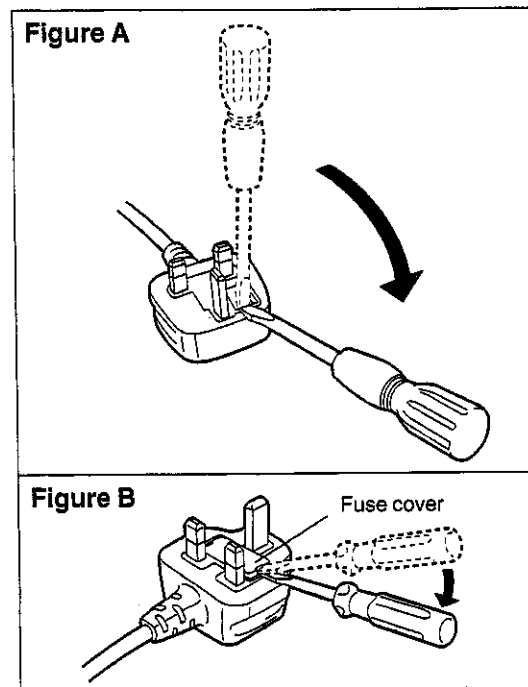

2. Replace the fuse and close or attach the fuse cover.

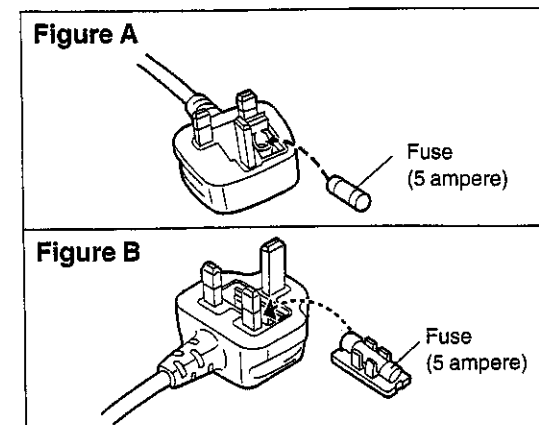

Preparing for the remote control

A Insert the batteries in the correct polarities (⊕, ⊖).

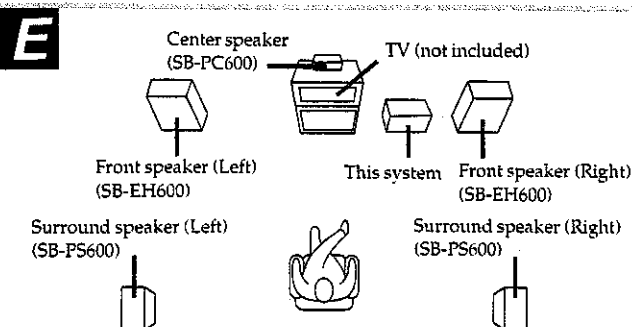
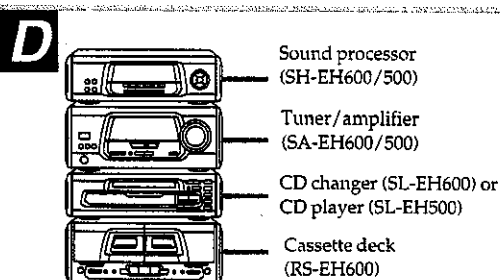
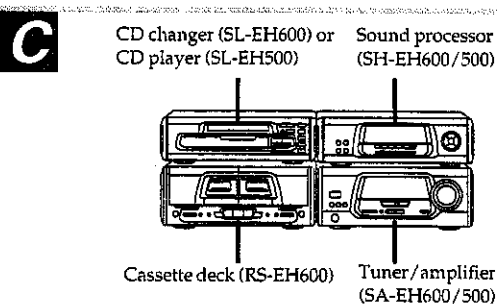
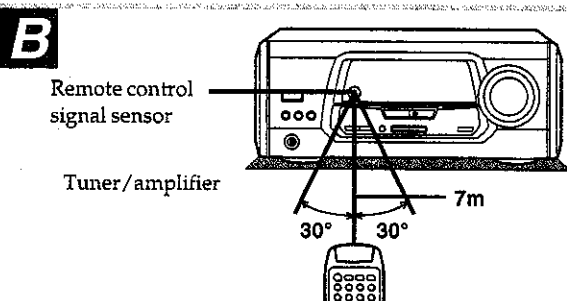
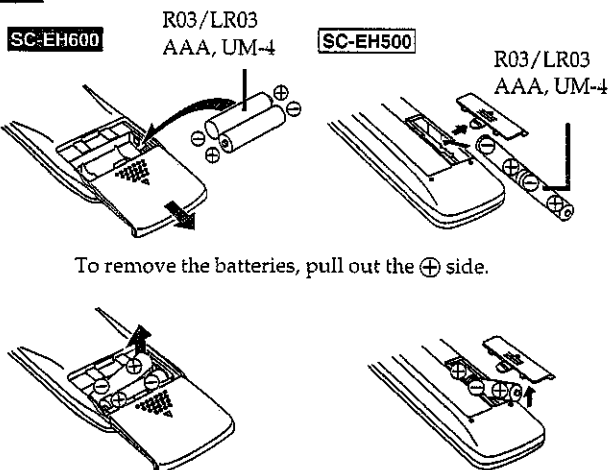

Battery installation

- Do not mix old and new batteries, or batteries of different types (manganese and alkaline, etc.).
- Never subject batteries to excessive heat or flame; do not attempt to disassemble them; and be sure they are not short-circuited.
- If the remote control is not to be used for a long period of time, remove the batteries and store them in a cool, dark place.
- Do not attempt to recharge alkaline or manganese batteries.
- Do not use rechargeable type batteries.

Correct method of use

- Aim the remote control's transmission window toward the unit's sensor. Avoid any obstacles.
- Be sure the transmission window and the unit's sensor are free from dust. Excessive dust might affect its performance.
- This unit may not operate correctly if direct sunlight or another strong light source strikes the receiving sensor of this unit. If there is a problem, place the unit away from the light source.
- Never place heavy items.
- Do not disassemble or reconstruct.
- Do not spill water or other liquids.

Installation

Locating the components

Side-by-side set-up **C**
Stacking **D**

Placement of speakers

SC-EH600 only

As well as enjoying normal stereo reproduction with the left and right front speakers, a center speaker and surround speakers can also be connected to the unit in order to enjoy the sound performance of DOLBY PRO LOGIC Systems.

We recommend that surround speakers be placed on the side of or slightly behind the listener, and about one meter higher than ear level.

However the position should be adjusted to your personal preference, because the effect varies to some degree depending upon the type of music and the music source.

Note for front/center speakers

These speakers are made so as to be able to be used in close proximity to the TV, but irregular coloring may result due to how the system is placed. If such distortion occurs, turn off the TV for sometime between 15 and 30 minutes. The demagnetizing function of the TV will eliminate the distortion. If the irregular coloring is still visible, then move the speaker further away from the TV.

Please note that if there is a magnetic object near the TV, irregular coloring may result due to the interaction between the TV and the speakers.

Connections

The illustrations show SC-EH600.
Connect the AC mains lead after you have connected all other cables.

For Australia and N.Z.

The configuration of the FM antenna terminal is different.

To prepare the AM loop antenna wire and speaker cords, twist the vinyl cover tip and pull off.

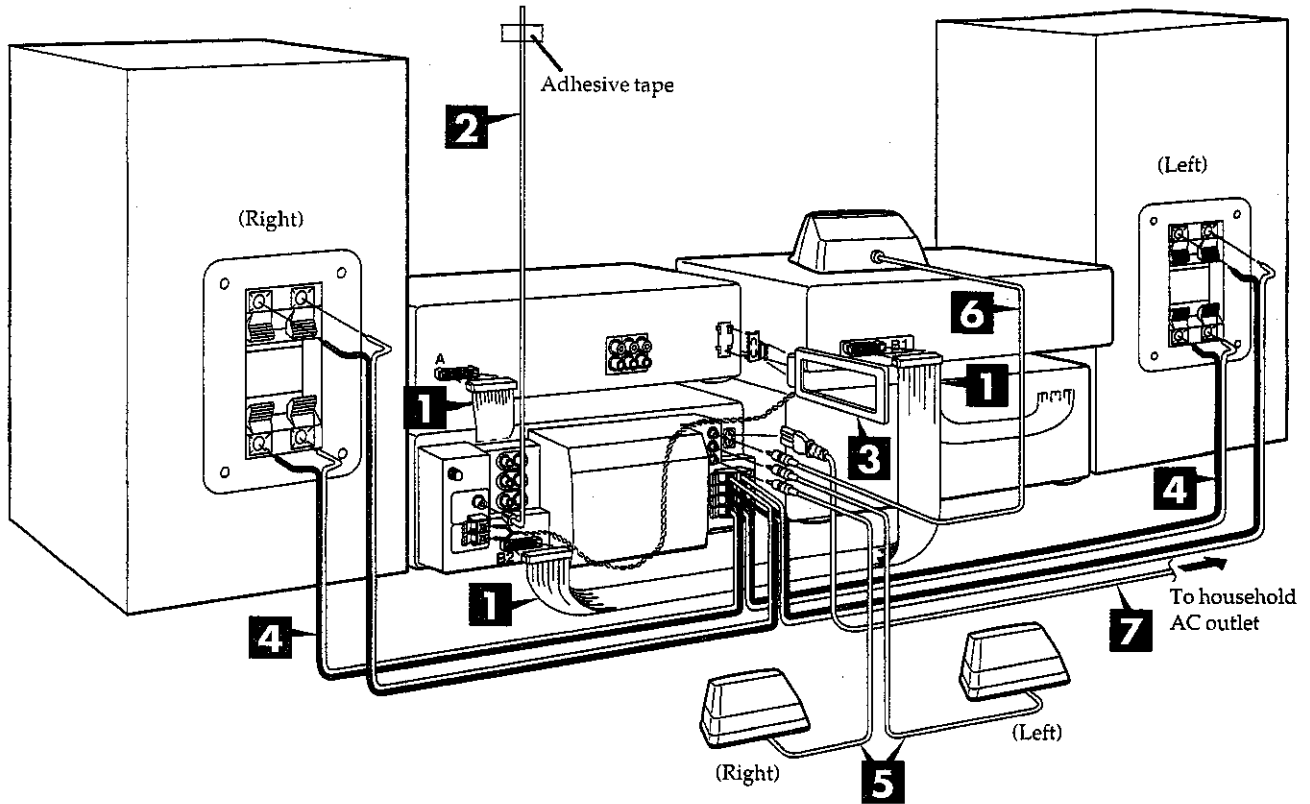
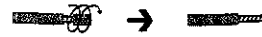

<p>1</p> <p>To connect cables</p> <p>Connector</p> <p>White line</p> <p>To unplug cables</p> <p>Hold the connector from both ends and pull it out.</p>	<p>3</p> <p>1</p> <p>2</p>	<p>5 Attaching to wall</p> <p>Slit</p> <p>140 mm</p> <p>30-35 mm</p> <p>Ø7.5-9.5</p> <p>7-9 mm</p> <p>Screws (not included)</p>
<p>2 (For Australia and N.Z.)</p> <p>Twist</p> <p>FM ANT 75Ω</p> <p>(For others)</p> <p>FM ANT 75Ω</p>	<p>4 Tuner/amplifier side</p> <p>Gray (+) Blue (-) Black (-)</p> <p>Red (+)</p> <p>Speaker side</p> <p>Blue (-)</p> <p>Gray (+) Black (-) Red (+)</p>	<p>7 (Insertion of Connector)</p> <p>Appliance inlet</p> <p>Connector</p> <p>Approx. 6 mm</p>

Before use

1 Connect the flat cables.

1. Connect the shorter flat cable from the tuner/amplifier to terminal A on the sound processor.
2. Connect the longer flat cable from the cassette deck to terminals B1 and B2.

Note

Do not try connecting or disconnecting the flat cables while the power is switched to ON.

After connection:

Keep cables as flat against the back of the unit as possible.

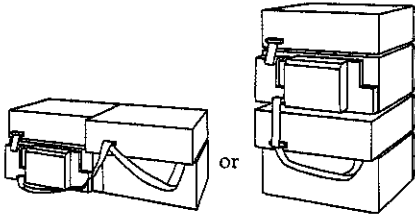

2 Connect the FM indoor antenna.

Tape the antenna to a wall or column, in a position where radio signals are received with the least amount of interference.

Note

When you cannot get good reception with this FM indoor antenna, we recommend you install an FM outdoor antenna (not included).

3 Connect the AM loop antenna.

1. Attach the antenna holder to the rear panel of the sound processor.
Then clamp the antenna into the antenna holder.
2. Connect the antenna terminal to the rear panel of the tuner/amplifier.

Note

To minimize noise pickup, bundle the loop antenna cord using tape or the like to keep the flat cables away from the AM loop antenna cord.

4 Connect the right (R) and left (L) front speaker cables.

Connect each end of the speaker cables to the terminal lever of the same color.

Note

- To prevent damage to circuitry, never short-circuit positive (+) and negative (-) speaker wires.
- Be sure to connect only positive (red or gray) wires to positive (+) terminals and negative (black or blue) wires to negative (-) terminals.
- Left and right front speakers are exactly the same.

5 SC-EH600 only

Connect the surround speaker cables.

Check the L (Left) or R (Right) channels indication on the underside of the speakers for correct placement. Place the speakers with the Technics logo facing forward the listening position.

Attaching to wall

- Set speaker onto screws and slide through bracket kink to lock into position.
- The wall or pillar on which the speaker systems are to be attached should be capable of supporting a weight of 5 kilograms.
- Feed wire through slit to fix from center-top of speaker.

6 SC-EH600 only

Connect the center speaker cables.

7 Connect the AC mains lead.

(United Kingdom only)

BE SURE TO READ THE CAUTION FOR AC MAINS LEAD ON PAGE 4 BEFORE PROCEEDING TO STEP 7.

Insertion of Connector

Even when the connector is perfectly inserted, depending on the type of inlet used, the front part of the connector may jut out as shown in the drawing.

However there is no problem using the unit.

Speaker caution

Use the speakers only with the recommended system. Failure to do so may lead to damage to the amplifier and/or the speaker, and may result in the risk of fire. Consult a qualified service person if damage has occurred or if you experience a sudden change in performance.

When speakers are connected to the LOW and HIGH terminals on the back of the main unit

They are designed to have a combined impedance of 6Ω.

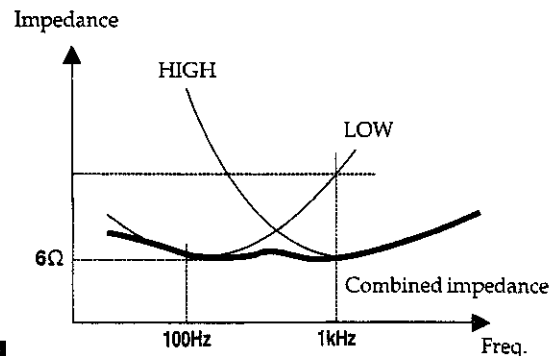

Note

Never use speakers other than those supplied. (SB-EH600) For instance, if you connect speakers with an impedance of 6Ω each and plug them into the LOW and HIGH terminals, you will only have a combined impedance of 3Ω

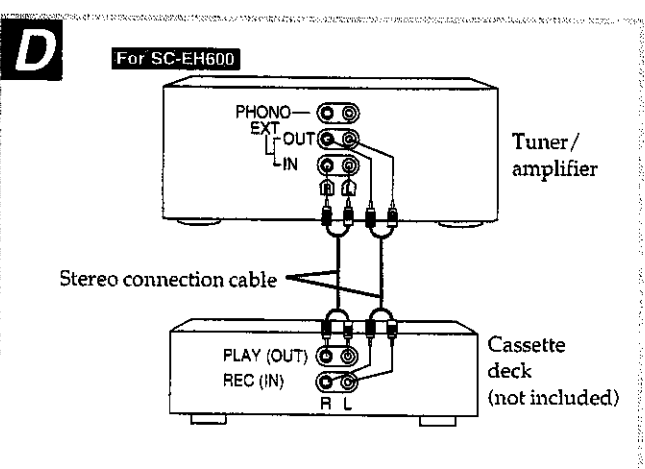
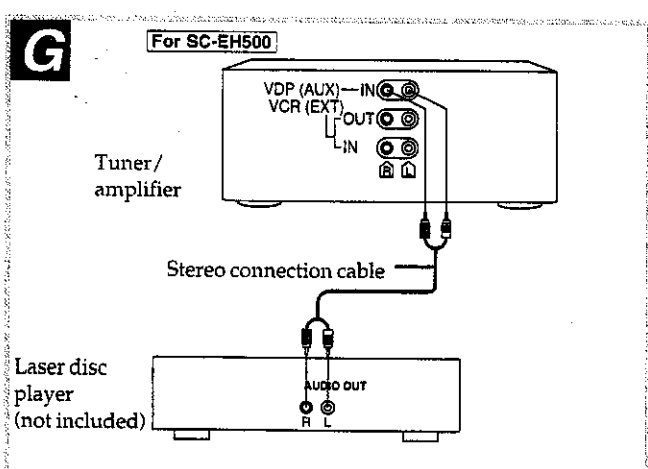
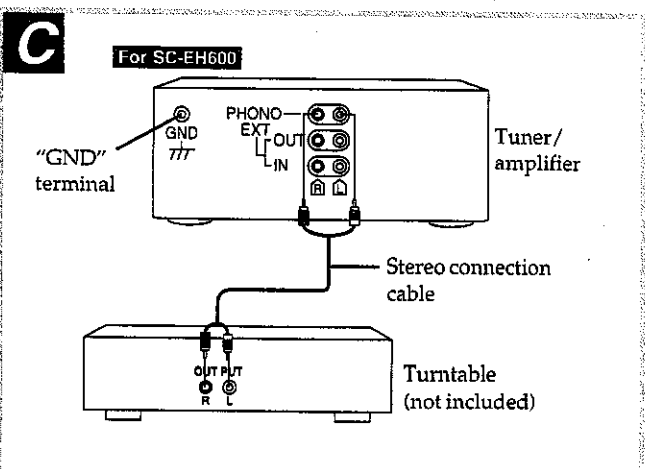
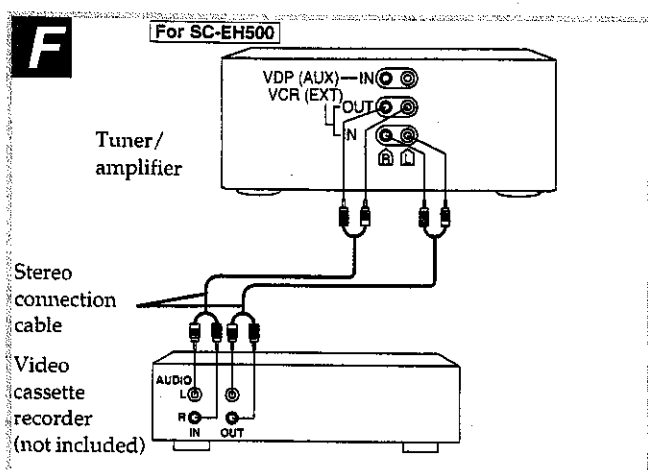
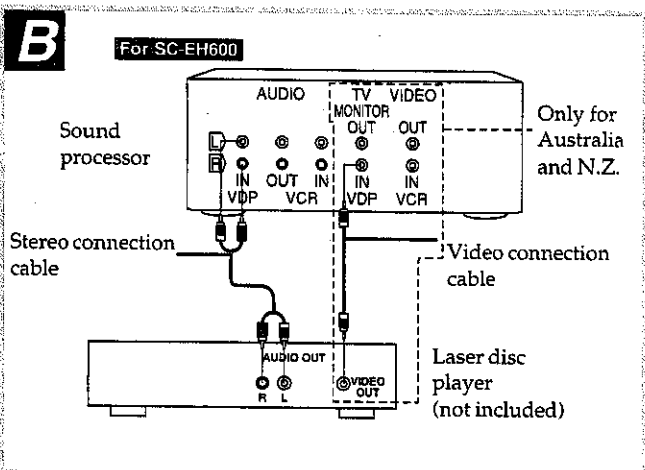
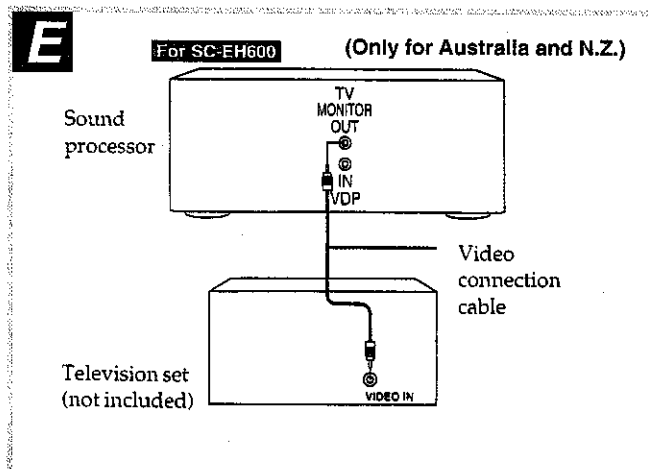
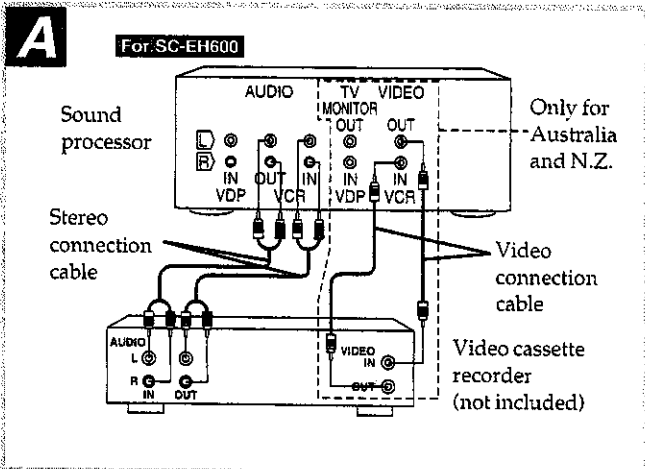

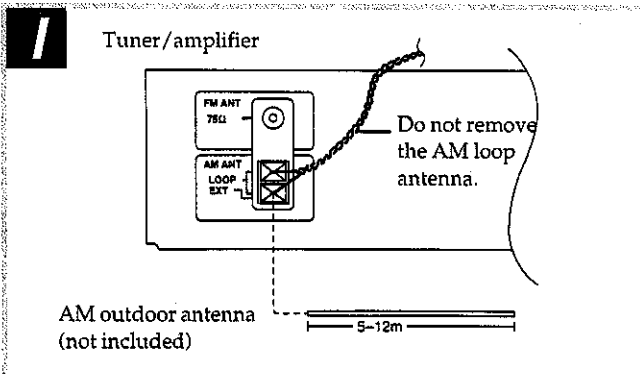
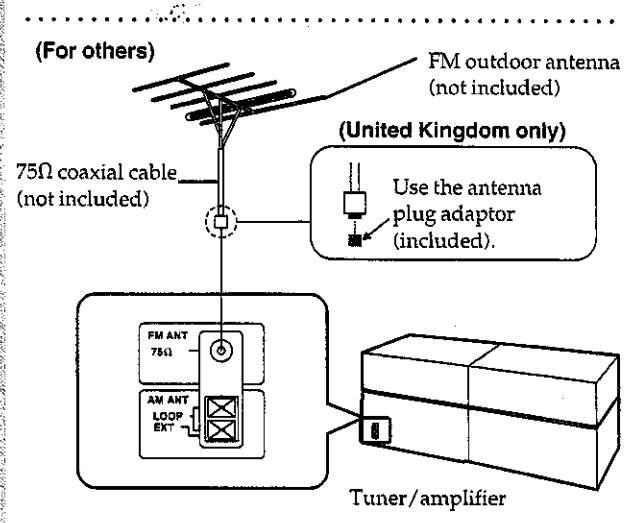
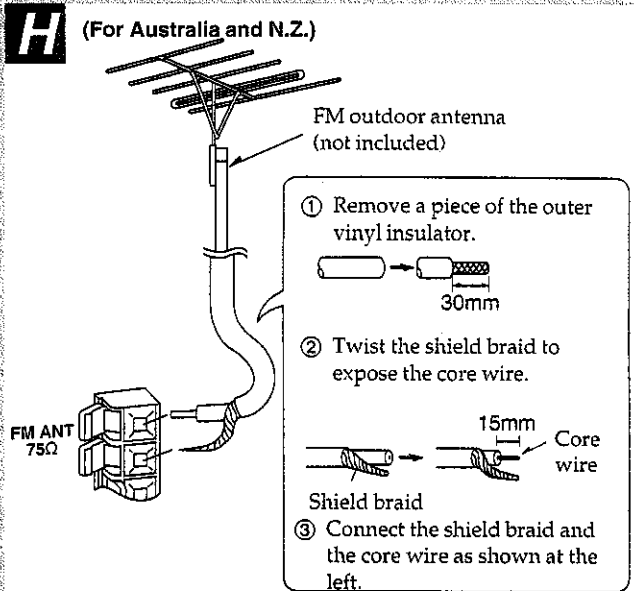

Connections

External unit connections

- Make sure that the power supply for all components has been turned off before making any connections.
- For details, refer to the operating instructions of the units which are to be connected.
- All peripheral components and cables sold separately.

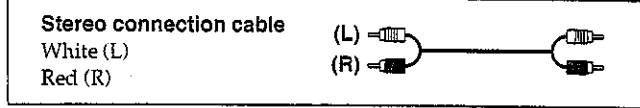

Connecting the SC-EH600

- A** Video Cassette recorder
- B** Laser disc player
- C** Turntable
- “GND” terminal:
This terminal is for a ground wire.
- D** Cassette deck
- E** Television set (For Australia and N.Z. only)

Connecting the SC-EH500

- F** Video Cassette recorder
- G** Laser disc player

Optional antenna connections

You may need an outdoor antenna if you use this system in a mountainous region or inside a reinforced-concrete building, etc.

FM outdoor antenna (not included) **F**

Note

An outdoor antenna should be installed by a qualified technician only.

AM outdoor antenna (not included) **G**

Connect the outdoor antenna without removing the AM loop antenna. Run 5 to 12 m of vinyl-covered wire horizontally along a window or other convenient location.

Note

When the unit is not in use, disconnect the outdoor antenna to prevent possible damage that may be caused by lightning. Never use an outdoor antenna during an electrical storm.

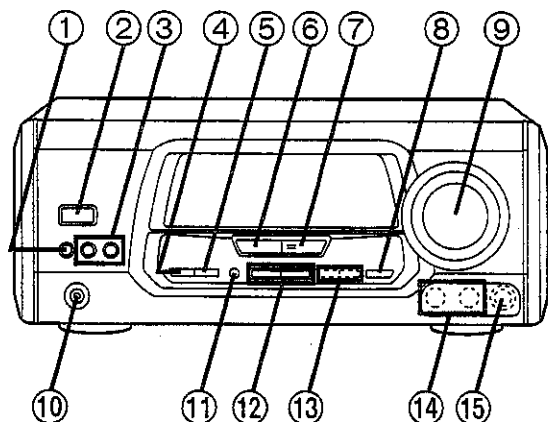
A**B**

SL-EH600

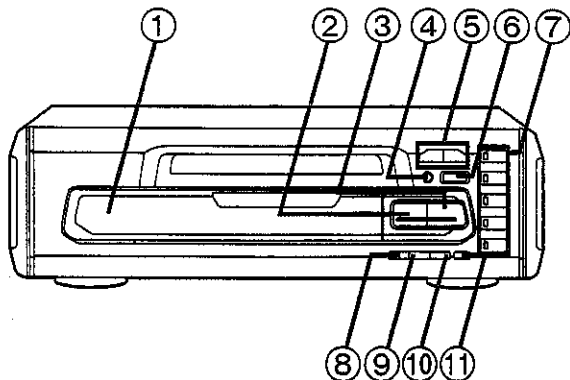
**C**

SL-EH500

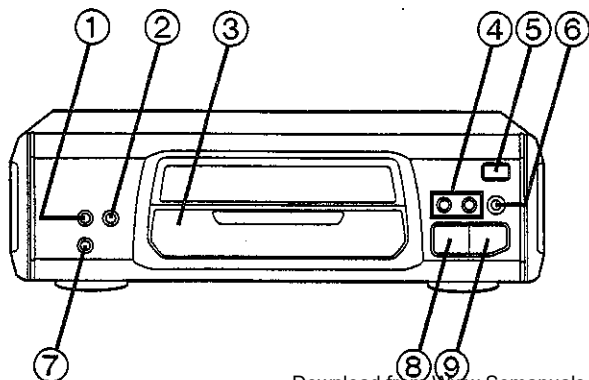

Front panel controls

Tuner/amplifier section

- ① Clock/timer button (CLOCK/TIMER)
 - ② Power "STANDBY \odot /ON" switch (POWER, STANDBY \odot /ON)
Press to switch the unit from on to standby mode or vice versa. In standby mode, the unit is still consuming a small amount of power.
 - ③ Timer on/off buttons (\ominus PLAY, \ominus REC)
 - ④ Tuning mode select button (TUNING MODE)
 - ⑤ Set button (SET)
 - ⑥ Source input select button (INPUT SELECTOR)
 - ⑦ Tuner/band select button and indicator (TUNER/BAND)
 - ⑧ Super woofer button (S.WOOFER)
 - ⑨ Volume control (VOLUME)
 - ⑩ Headphones jack (PHONES)
 - ⑪ FM mode select button (FM AUTO/MONO)
 - ⑫ Tuning buttons (\vee , \wedge TUNING)
- (For areas except UK, Australia and N.Z.)
- ⑬ RDS display mode select buttons (RDS PS-DISP MODE-PTY)

(For Australia and N.Z. only)

- ⑬ KARAOKE and echo buttons (KARAOKE, ECHO)

(For Australia and N.Z. only)

- ⑭ Microphone jacks (MIC, 1, 2)
- (For Australia and N.Z. only)
- ⑮ Microphone volume control (MIC VOL)

CD changer section

SL-EH600 **B**

- ① Disc tray
- ② Stop button (■)
- ③ Play button and indicator (\triangleright)
- ④ Pause button (||)
- ⑤ Skip/search buttons (\llcorner / \llcorner , \gg / \gg)
- ⑥ Disc tray open/close button (\blacktriangle OPEN/CLOSE)
- ⑦ Disc select buttons and indicators (DISC, 1-5)
- ⑧ Random play button (RANDOM)
- ⑨ Repeat button (REPEAT)
- ⑩ AI edit button (AI EDIT)
- ⑪ Disc check button (\blacktriangle NEXT OPEN)

CD player section

SL-EH500 **C**

- ① Random play button (RANDOM)
- ② Repeat button (REPEAT)
- ③ Disc tray
- ④ Skip/search buttons (\llcorner / \llcorner , \gg / \gg SKIP/SEARCH)
- ⑤ Disc tray open/close button (\blacktriangle OPEN/CLOSE)
- ⑥ Pause button (||)
- ⑦ AI edit button (AI EDIT)
- ⑧ Stop button (■)
- ⑨ Play button and indicator (\triangleright)

Front panel controls

Before use

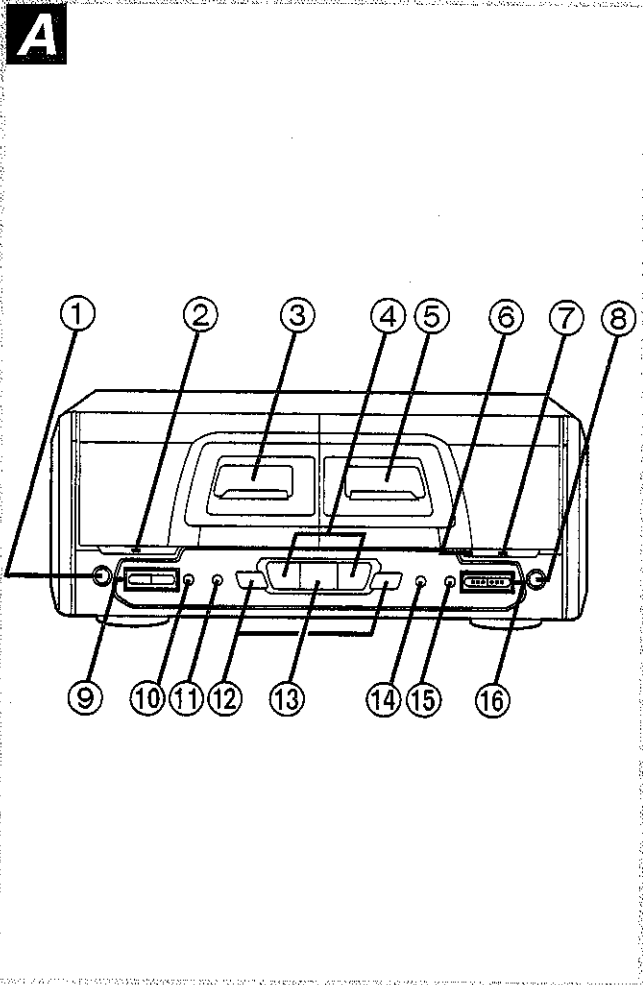

Cassette deck section

- ① Deck 1 cassette holder open button (\blacktriangle OPEN)
- ② Deck 1 indicator (DECK 1)
- ③ Deck 1 cassette holder
- ④ Playback buttons and indicators (\triangleleft , \triangleright)
- ⑤ Deck 2 cassette holder
- ⑥ Record pause indicator (REC PAUSE)
- ⑦ Deck 2 indicator (DECK 2)
- ⑧ Deck 2 cassette holder open button (\blacktriangle OPEN)
- ⑨ Counter reset, display buttons (COUNTER, RESET, DISPLAY)
- ⑩ Deck 1/deck 2 select button (DECK 1/2)
- ⑪ Reverse mode select button (REV MODE)
- ⑫ Fast forward/rewind buttons (\ll , \gg)
- ⑬ Stop button (\blacksquare)
- ⑭ Dolby noise reduction button (DOLBY NR)
- ⑮ Record pause button (\bullet REC PAUSE)
- ⑯ Tape edit buttons (TAPE EDIT, NOR, HIGH)

Sound processor section

- ① EQ SPACE on/flat button (EQ SPACE ON/FLAT)
- ② Display mode select/demonstration button (DISP MODE/-DEMO)
- ③ Display
- ④ **SH-EH600 only**
DOLBY PRO LOGIC indicators (SURROUND, 3 STEREO, NORMAL, WIDE, PHANTOM)
- ⑤ Multi control buttons (\blacktriangleright , \blacktriangle , \blacktriangleleft , \blacktriangledown MULTI CONTROL)
- ⑥ Acoustic image EQ button (ACOUSTIC IMAGE EQ)
- ⑦ EQ SPACE preset/manual select button (PRESET/MANUAL)
- ⑧ **SH-EH600 only**
DOLBY PRO LOGIC on/off button (DOLBY PRO LOGIC, OFF/ON)
- ⑨ **SH-EH600 only**
DOLBY PRO LOGIC mode select button (MODE)
- ⑩ **SH-EH600 only**
DOLBY PRO LOGIC test signal button (TEST)
- ⑪ **SH-EH600 only**
DOLBY PRO LOGIC center mode select button (CENTER MODE)

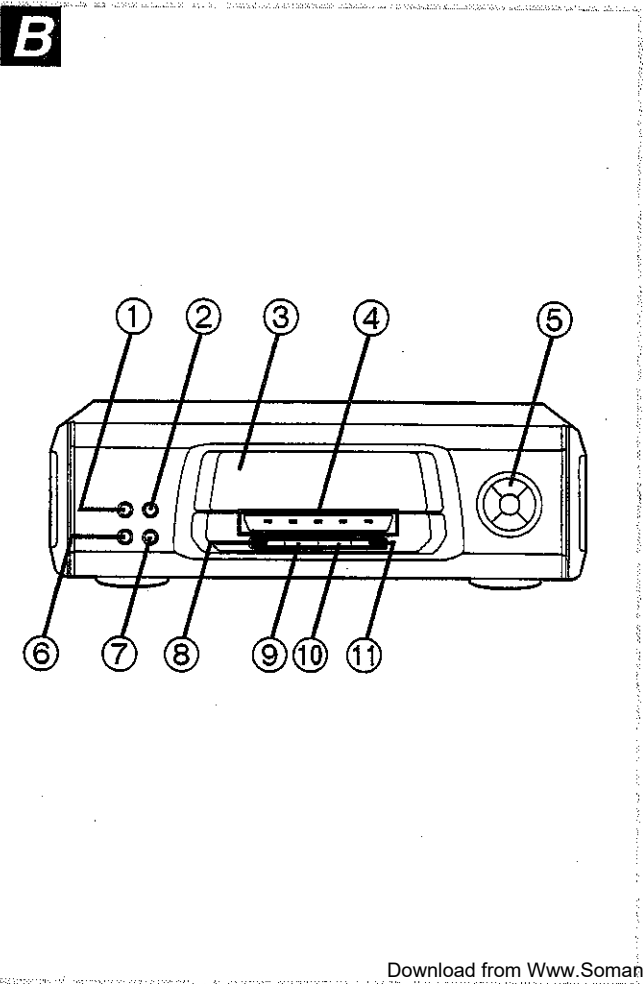

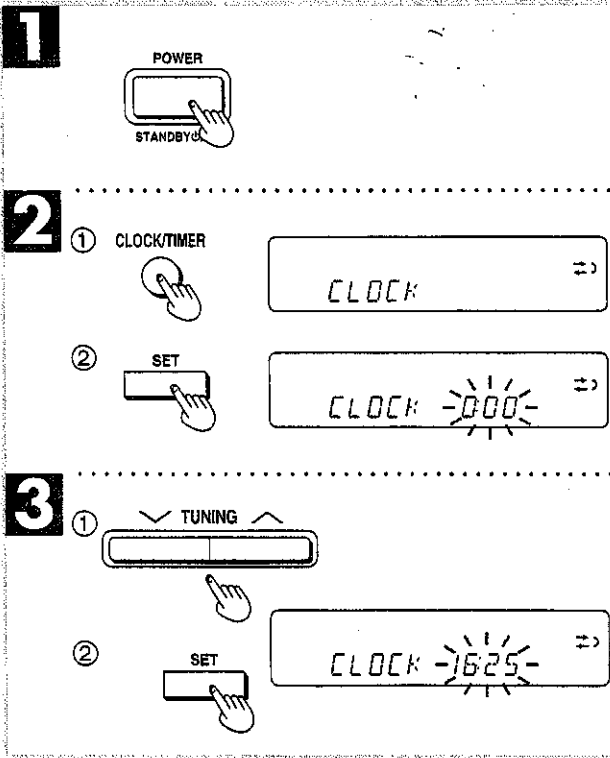
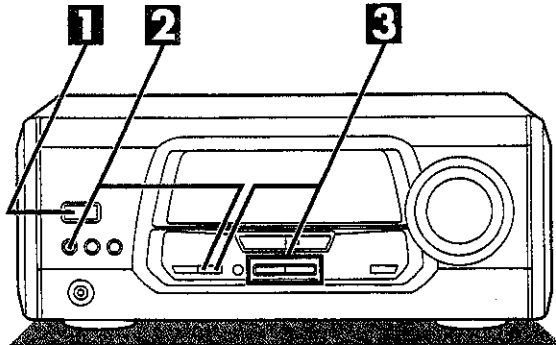
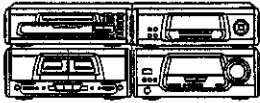

Setting the time

The tuner/amplifier displays the time, frequency and other information on CDs and tapes.

This is a 24-hour display clock.

The figure shows how to set the time for 16:25.

1 Switch on the power.

2 ① Press CLOCK/TIMER to show "CLOCK".

Every time you press the button, the indication changes in the order of CLOCK → ⊕ PLAY → ⊕ REC → Original display.

Within 5 seconds:

② Press SET.

3 ① Press TUNING (∨ or ∧) to set the present time on the display.

The time display can be changed in one minute units by tapping the buttons, and quickly by holding down the buttons.

② Press SET.

The display will return to the previous display after about 3 seconds.

When "----" appears:

It appears when you connect the AC power supply cord for the first time or if there has been a power failure. Reset the time as explained above.

If the minutes setting is off:

1. Press CLOCK/TIMER.
2. Press SET.
3. Press TUNING (∨ or ∧) to set the minutes, and then press SET.

To display the clock again:

Press CLOCK/TIMER.

The clock display will appear for about 5 seconds.

For your reference:

When you turn OFF the system from the POWER button, the system goes on standby.

Demo function while the power is on:

When the input source is set to "CD" or "TAPE", the demo function will run automatically after about 2 minutes in the stop mode.

You can cancel the demo function by pressing and holding DISP MODE/-DEMO for about 2 seconds while the automatic demo function is activated.

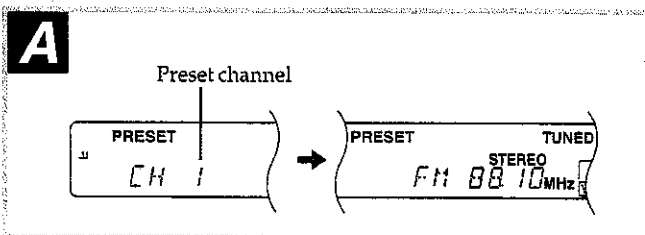
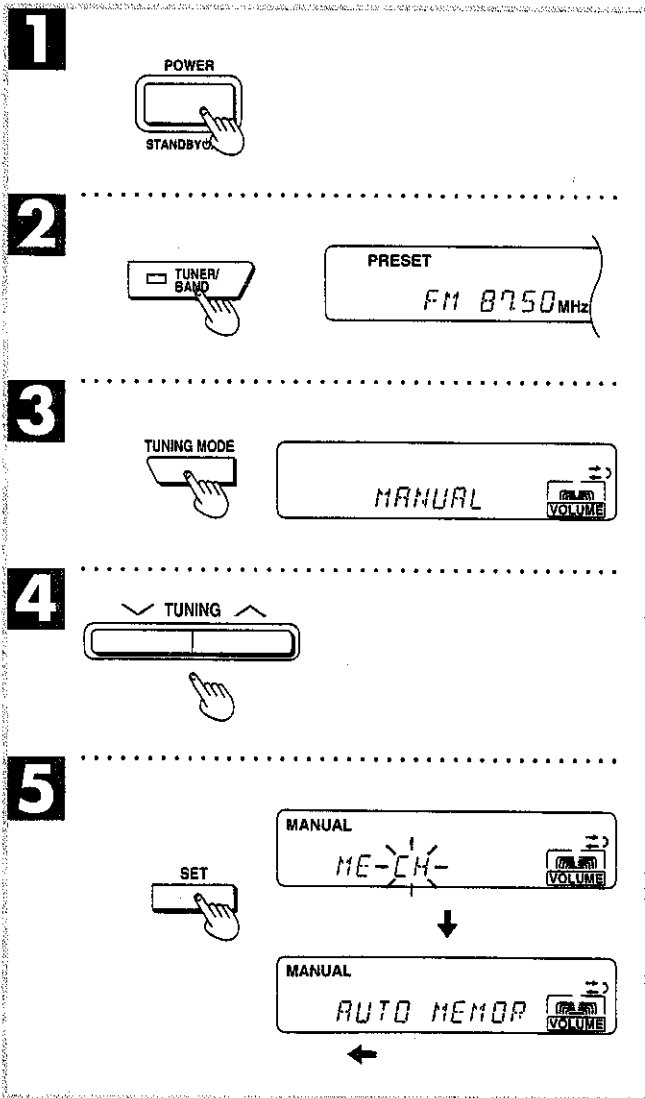
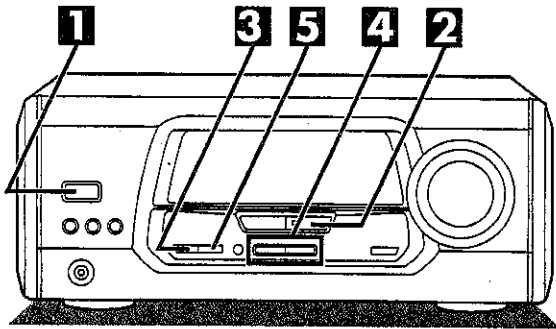
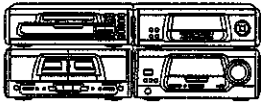

Memory presetting

- Once stations have been preset, you can easily select them from the tuner/amplifier or the remote control.
- You can preset a total of 39 stations between the FM and AM bands.
- Stations can be set automatically or manually.

Automatic memory presetting

The frequencies are automatically preset (in sequence from lower to higher frequencies) into the memory: "channels" 1 to 39 are available for the presetting of FM stations and "channels" 21 to 39 are available for AM stations.

This example in the figure shows how to preset FM stations.

- 1 Switch on the power.**
- 2 Press TUNER/BAND to select the desired band.**
Each time you press this button, "FM" and "AM" will appear alternately.
- 3 Press TUNING MODE to select "MANUAL".**
Each time you press this button, "MANUAL" and "PRESET" will appear alternately.
- 4 Press and hold TUNING (∨ or ∧) until the display shows the frequency from which you want to begin automatic memory presetting.**
Press TUNING (∨ or ∧) momentarily to stop scrolling when the displayed frequency approaches the desired frequency. Tap TUNING (∨ or ∧) a few times until the desired frequency is reached.
- 5 Hold down SET.**
Release your finger when the words "AUTO MEMORY" scroll across the display.

The "ME" in the display will then flash while the tuner/amplifier is storing the received frequency in memory. When storing is complete, "SET OK" will be displayed.

To confirm the preset stations: **A**

1. Press TUNING MODE to select "PRESET".
2. Press TUNING (∨ or ∧).

"STEREO" lights when an FM stereo broadcast is being received.
"TUNED" lights when you precisely tune in a broadcast station.

When "ERROR" appears:

Automatic memory presetting does not work when radio waves from the broadcasting station are too strong or too weak.
In such case, carry out presetting manually. (See page 14.)

Note

When you preset a broadcast station to a channel that has already been preset, the previous presetting will be erased. So if, for example, FM frequencies are preset from channel 1 to 39 and then AM frequencies are preset, the first AM frequency will be preset to channel 21 (thus erasing the FM presetting to channel 21), the second AM frequency will be preset to 22 (erasing FM 22), and so on.

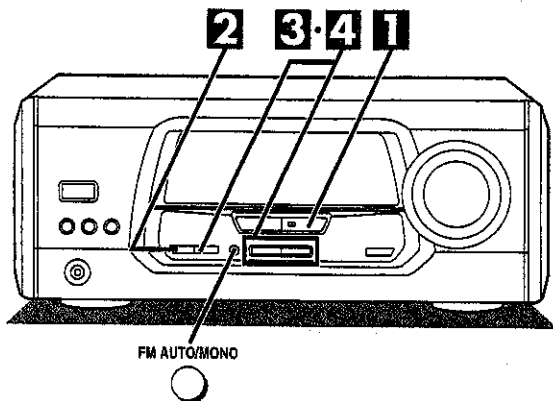
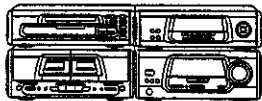

Memory presetting

Manual memory presetting

This example in the figure shows how to store FM 88.10 MHz into preset channel 1.

- 1** Press **TUNER/BAND** to select the desired band. Each time you press this button, "FM" and "AM" will appear alternately.
- 2** Press **TUNING MODE** to select "MANUAL". Each time you press this button, "MANUAL" and "PRESET" will appear alternately.
- 3** **1** Press **TUNING (∨ or ∧)** to tune in the desired broadcast.

"STEREO" lights when an FM stereo broadcast is being received.
 "TUNED" lights when you precisely tune in a broadcast station.

Automatic scanning:

Press and hold **TUNING (∨ or ∧)** until the displayed frequency starts to scroll.

- The scrolling of the displayed frequency will automatically stop if a broadcast station frequency is located during the tuning process.
- When there is excessive interference, automatic scanning may not function.

To cancel automatic scanning, press **TUNING (∨ or ∧)** once again.

- 2** Press **SET** momentarily.

"CH" flashes.

- 4** **1** Press **TUNING (∨ or ∧)** to select the desired preset channel.

- 2** Press **SET** momentarily.

"CH" lights and the display returns to the frequency after about two seconds.

To continue presetting:

Repeat steps **1** through **4**.

To preset FM stations in monaural position:

1. Select the desired frequency.
2. Press **FM AUTO/MONO**. "MONO" will light.
3. Follow steps **3-2** and **4** above.

Memory retention

Even if the power cord is disconnected from the household AC outlet, the memory will retain its contents for approximately 2 weeks.

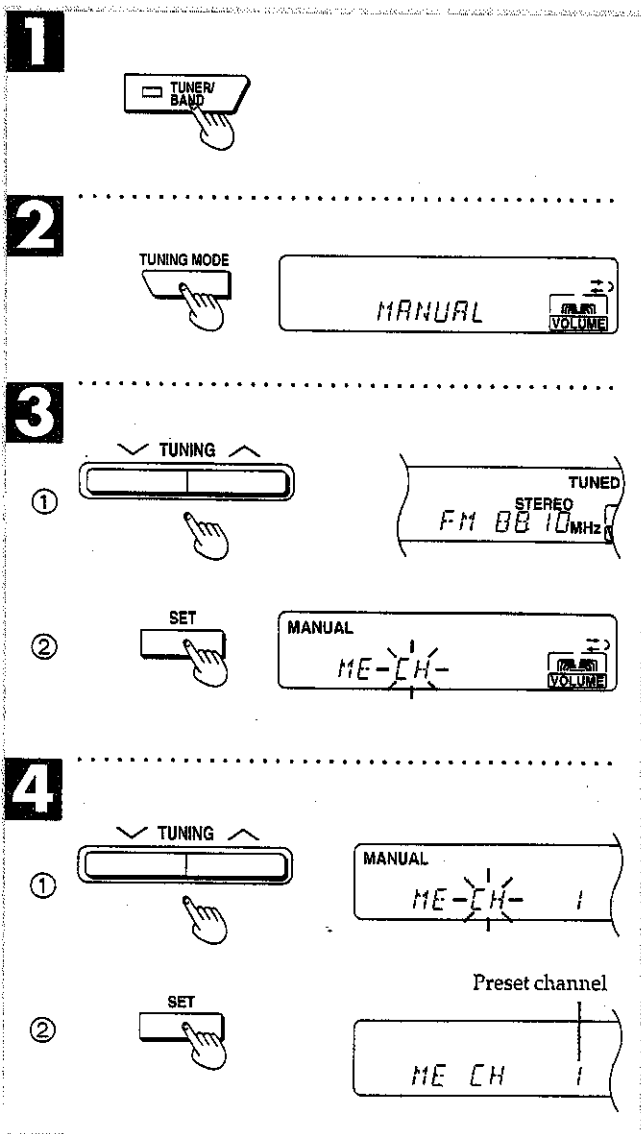

Listening to radio broadcasts

This example in the figure shows how to tune in FM stations.

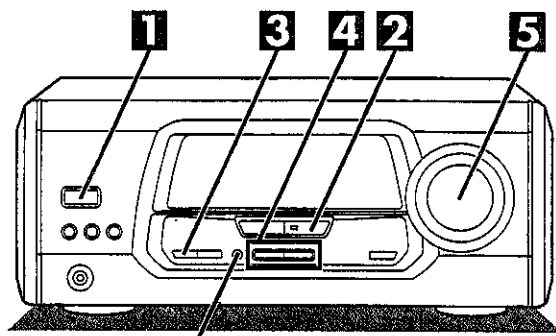
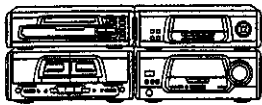

FM AUTO/MONO

1 POWER

STANDBY

4 TUNING

(When you select "PRESET")

2 TUNER/BAND

FM 87.50MHz VOLUME

(When you select "PRESET")

3 TUNING MODE

(When you select "PRESET")

(When you select "MANUAL")

5

(When you select "MANUAL")

1 Switch on the power.

2 Press TUNER/BAND to select the desired band. Each time you press this button, "FM" and "AM" will appear alternately.

3 Press TUNING MODE to select "PRESET" or "MANUAL".

Each time you press this button, "MANUAL" and "PRESET" will appear alternately.

•Select "PRESET" when stations are preset.

(Refer to "Memory presetting" on pages 13 or 14 to preset stations.)

•Select "MANUAL" when stations are not preset.

4 Press TUNING (∨ or ∧) to tune in the desired broadcast.

"STEREO" lights when an FM stereo broadcast is being received.

"TUNED" lights when you precisely tune in a broadcast station.

Automatic scanning (when you select "MANUAL" in step 3):

Press and hold TUNING (∨ or ∧) until the displayed frequency starts to scroll.

•The scrolling of the displayed frequency will automatically stop if a broadcast station frequency is located during the tuning process.

•When there is excessive interference, automatic scanning may not function.

To cancel automatic scanning, press TUNING (∨ or ∧) once again.

5 Adjust the volume level.

For tuning by remote control (when you select "PRESET" in step 3 above):

Specify the channel you want with the numeric buttons (see page 53 or 54).

To select a two-digit channel:

Press ≥10 and then the two numbers you want within 10 seconds or so.

Note

If an FM station is preset to "MONO", the "STEREO" indicator will not light up even if a stereo broadcast is being received.

If noise is excessive in the FM stereo mode: A

Press FM AUTO/MONO.

The sound reception mode switches to "MONO" (monaural) and "MONO" lights.

The sound will then be heard in monaural. If the broadcast signal is weak, or if there is a large amount of interference, you will get a clearer sound using MONO function.

To cancel the "MONO" mode, press the button again.

When "MONO" indicator goes off:

Use this setting for normal listening. Both stereo and monaural sounds can be heard as they are.

Note

If you change frequencies in the "MONO" mode, the "MONO" mode will be cancelled.

One-touch play B

When the system is OFF, you can receive the station last tuned in when you press TUNER/BAND on the remote control.

Play will start with volume increasing gradually.

A FM AUTO/MONO

TUNED MONO FM 88.10MHz VOLUME

B SC-EH600

SC-EH500

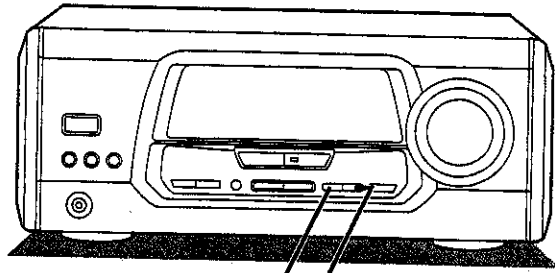
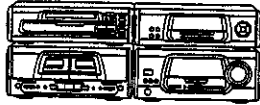

RDS
PS - DISP MODE - PTY

A

RDS
PS - DISP MODE

RDS PS
BAYERN 1

VOLUME

B

RDS
DISP MODE - PTY

RDS PTY
NEWS

VOLUME

Enjoying RDS broadcasts

(For areas except UK, Australia and N.Z.)

This unit lets you take advantage of the Radio Data System (RDS) in areas where RDS broadcast services are received. This advanced system provides useful information, utilizing a 57 kHz subcarrier above the audible range, in addition to the main FM signal.

Types of RDS and functions

To display the name of a broadcast station (PS display):
When this system receives a PS signal in an RDS broadcast, the name of the broadcast station is shown on the display.

To display the type of a program (PTY display):
While the PTY signal is being received, the name of the type of program currently being broadcast can be shown on the display.

Notes

- Even if an FM broadcast station is transmitting RDS signals, the functions of this system may not be able to utilize these signals if the signal quality is too poor.
- "PTY" may not be available in some areas. (Future function)

To display the name of a broadcasting station **A**

(When the FM station is received)
Press PS-DISP MODE.

If the FM broadcast being received provides the RDS service ("RDS" indicator will light), the name of the broadcast station and "PS" indicator will be shown on the display of this system. Each time you press the button, frequency display and PS display will appear alternately.

To display the type of a program **B**

(When the FM station is received)
Press DISP MODE-PTY.

If the FM broadcast being received provides the RDS service ("RDS" indicator will light), the type of the program and "PTY" indicator will be shown on the display of this system. Each time you press the button, frequency display and PTY display will appear alternately. (For PTY displays, see page 17.)

Note

When receiving a broadcast station, in PTY mode, which does not transmit PTY, the display will not show "NO PTY" automatically.

About the PTY display

There are a total of 15 PTY displays on this unit. The table gives an explanation of each display.

Display	Explanation
NEWS	Short accounts of facts, events and publicly expressed views, reportage and actuality.
AFFAIRS	Topical program expanding or enlarging upon the news, generally in different presentation style or concept, including documentary debate, or analysis.
INFO	Program whose purpose is to impart advice in the widest sense, including meteorological reports and forecasts, consumer affairs, medical help, etc.
SPORT	Program concerned with any aspect of sport.
EDUCATE	Program intended primarily to educate.
DRAMA	All radio plays and serials.
CULTURE	Programs concerned with any aspect of national or regional culture, including religious affairs, philosophy, social science, language, theatre, etc.
SCIENCE	Programs about the natural sciences and technology.
VARIED	Used for mainly speech-based programs, usually of a light-entertainment nature not covered by above categories. Examples are: quizzes, panel games, personality interviews, comedy and satire.
POP M	Commercial music which would generally be considered to be of current popular appeal, often featuring in current or recent record sales charts.
ROCK M	Contemporary modern music, usually written and performed by young musicians.
M.O.R.M	(Middle of the Road Music). Common term to describe music considered to be "easy-listening", as opposed to Pop, Rock or Classical. Music in this category is often, but not always, vocal, and usually of short duration (<5 min.).
LIGHT M	Classical Musical for general, rather than specialist, appreciation. Examples of music in this category are instrumental music and vocal or choral works.
CLASSICS	Performances of major orchestral works, symphonies, chamber music etc., and including Grand Opera.
OTHER M	Musical styles not fitting into any of the above categories. Particularly used for specialist music, of which Jazz, Rhythm & Blues, Folk, Country, and Reggae are examples.

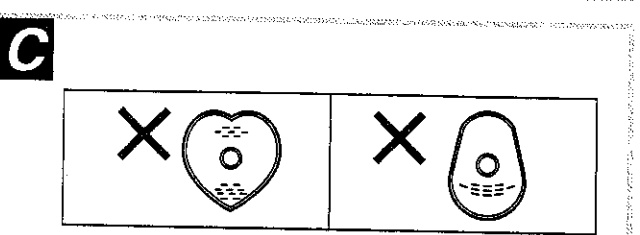
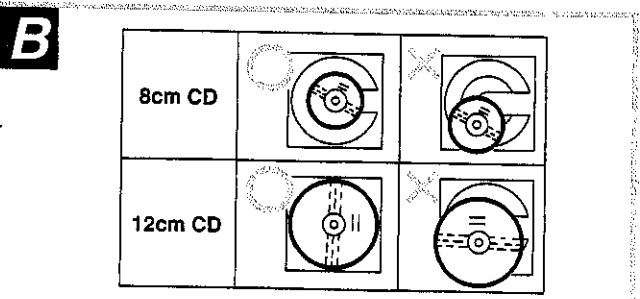
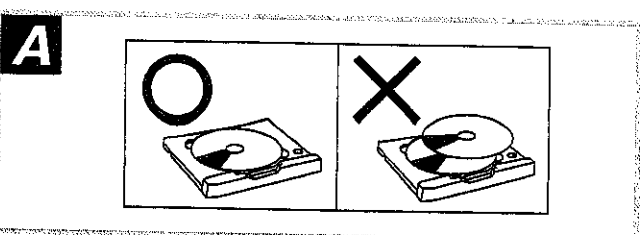
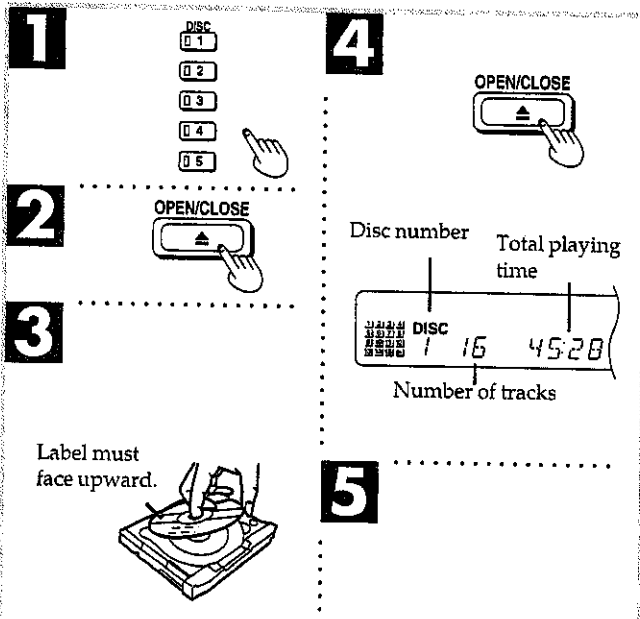
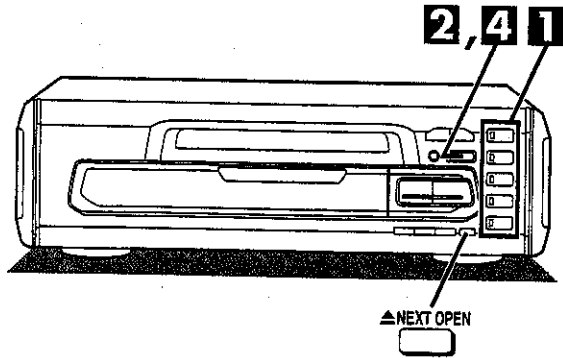
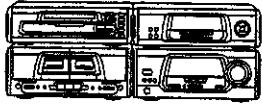

Listening to compact discs

For SC-EH600

Always stop the changer before loading or changing CDs. You cannot change CDs while a disc is playing.

How to load CDs

- 1** Press DISC 1-5, whichever you want to open.
- 2** Press \blacktriangle OPEN/CLOSE.
- 3** Set the CD in the tray.
- 4** Press \blacktriangle OPEN/CLOSE.
The tray will close.
- 5** To load other CDs, repeat steps **1** through **4**.

About disc indicators:

Green: Indicates that the tray is ready to play its CD or to be opened.

How to check which trays have discs

\blacktriangle NEXT OPEN is a convenient button to use for this function.

Press \blacktriangle NEXT OPEN.

The first tray to open will be the next one after the disc number shown on the display. For example, when disc 4 is displayed, tray 5 will open.

- Every time you press the button, the next tray opens.
- You can change the CD while the tray is open.
- To close the tray, press \blacktriangle OPEN/CLOSE.

To prevent damage

Always observe the following points.

- Load only 1 CD per tray. **A**
- Load CDs as shown in figure **B**.
An adapter is not needed with 8 cm CDs (singles).
Set the system on a flat, level surface.
Do not set it on top of magazines, inclined surfaces, etc.
- Do not move the system while trays are opening/closing, or when loaded.
Always unload all trays before moving the system.
- Do not put anything except CDs in trays.
- Do not use cleaning CDs or CDs which are badly warped or cracked.
- Do not use CDs with poorly attached labels or stickers. Adhesive protruding from underneath stickers or left over from peeled off stickers can cause the system to malfunction.
- Do not use irregular shaped CDs. **C**

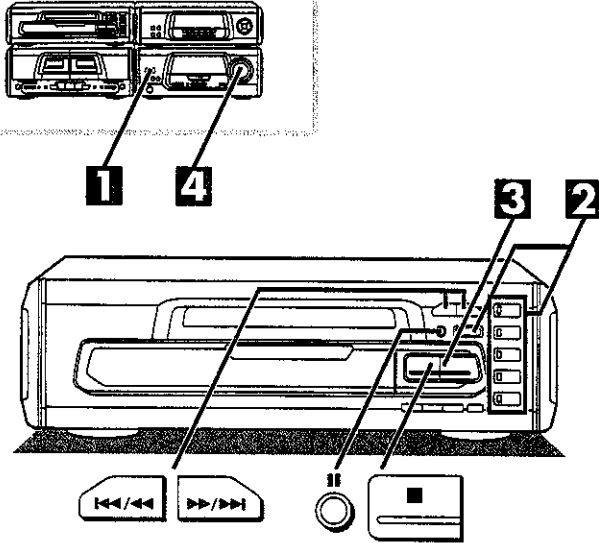

1

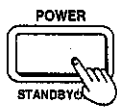

2

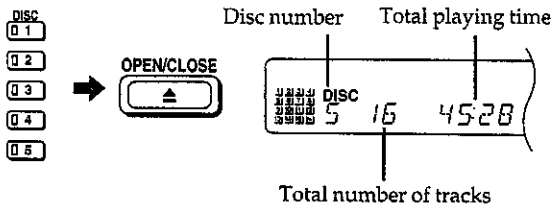

3

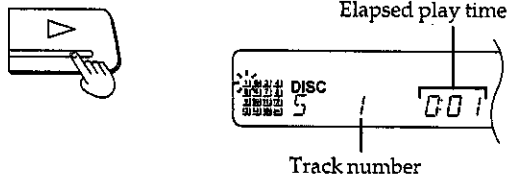

4

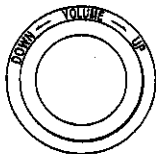

A

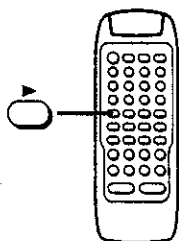

Sequential play

- 1** Switch on the power.
- 2** Insert CDs in the trays.
(For details, see page 18.)
When the "CD" input source is selected, disc number, total number of tracks, and total playing time will appear on the display.
When there are 16 or more tracks on the CD, "▶" will appear.

Note

The total playing time displayed when a disc is loaded includes intervals between tracks. This is why sometimes the displayed time is longer than that listed on the CD.

- 3** Press ▶.
The changer will automatically play all tracks on all discs. It will start from the first track on the disc shown on the display, and will continue until the last track of the final disc (see below).

- 4** Adjust the volume level.

To stop the disc:
Press ■.

To temporarily stop the disc:
Press ■■. The play indicator flashes green.
To play again, press ▶.

What is meant by "final disc"?:

For example, if play starts from disc 4, disc 3 will be the "final disc".

Order of progression:
Disc 4→5→1→2→3

About play indicator:

While halted: Lights up orange.
While playing: Lights up green.

For your reference:

If you press ▶ instead of ▲ OPEN/CLOSE after inserting a CD, the tray will close and play will start directly from the track 1.

To search forward/backward	Hold down during playback. ◀◀/◀◀ ▶▶/▶▶ (Backward) (Forward)
To skip forward/backward	Press. ◀◀/◀◀ ▶▶/▶▶ (Backward) (Forward)

Note

During random play, you cannot skip to tracks which have already been played. (page 20)

For your reference:

- During program play or random play, you cannot search-forward/backward over tracks. (pages 20 and 21)
- During program play, skipping is in always in the programmed order, whether forward or backward. (page 21)

One-touch play A

When the system is OFF, play starts automatically when you press ▶ on the remote control.
Play will start with volume increasing gradually.

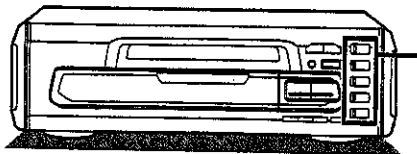
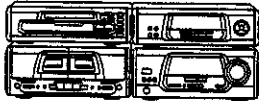
A

DISC
 1
 2
 3
 4
 5

Listening to compact discs For SC-EH600

Direct access play

To listen to a favorite CD **A**

Press DISC 1-5, whichever disc you want.

The selected CD will be played from the first track to the last track of the final disc (page 19).

Playback will stop automatically when the last track of the final disc is finished.

To listen to a favorite track **B**

by remote control only

1 Press CD.

2 Press DISC.

3 (within 10 seconds or so)

Press DISC 1-5, whichever disc you want.

4 Press the numeric button(s) to select the desired track number.

The CD will be played from the selected track to the last track of the final disc (page 19).

Playback will stop automatically when the last track is finished.

To select a two-digit track:

Press ≥ 10 and then the two numbers you want within 10 seconds or so.

Repeat play

This function repeats the play of all tracks.

Press REPEAT before or during play.

"" will light.

To cancel repeat play:

Press REPEAT once again.

"" will go out.

For your reference:

In program play mode (See page 21), the CD changer will repeat only the programmed tracks. You can enjoy the same track over and over by programming only one track.

Random play

Press RANDOM.

"RANDOM" will light, and then random play will start.

Play will stop automatically when all tracks on all of the discs finish playing randomly.

To cancel random play:

Press RANDOM once again.

"RANDOM" will go out. The CD changer resumes the sequential play mode.

For your reference:

In the program play mode (See page 21), the programmed tracks will be played randomly.

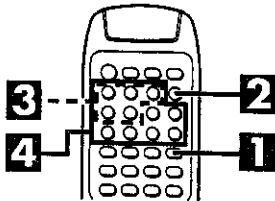
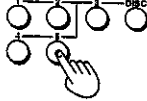
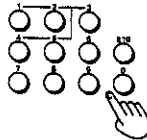
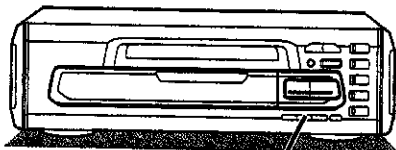
B**1****3****2****4****C**

REPEAT

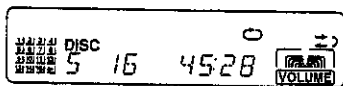
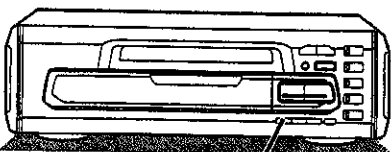
**D**

RANDOM

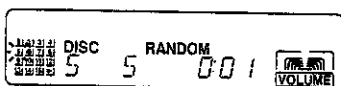

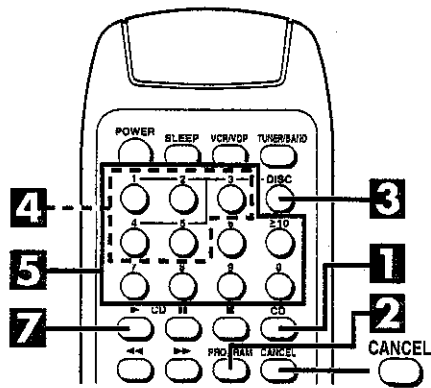

Program play

by remote control only

This function allows you to program up to 24 tracks.

- 1** Press CD.
- 2** Press PROGRAM.
- 3** Press DISC.
- 4** (within 10 seconds or so) Press DISC 1-5, whichever disc you want.
- 5** Press the numeric button(s) to select the track you want to play in the desired sequence.
To select a two-digit track: Press ≥ 10 and then the two numbers you want.
- 6** Repeat steps **3** through **5** until you have programmed all the tracks you want.
- 7** Press **▶**.
Play will start in the programmed sequence.
Play will stop automatically when all the programmed tracks have been played.

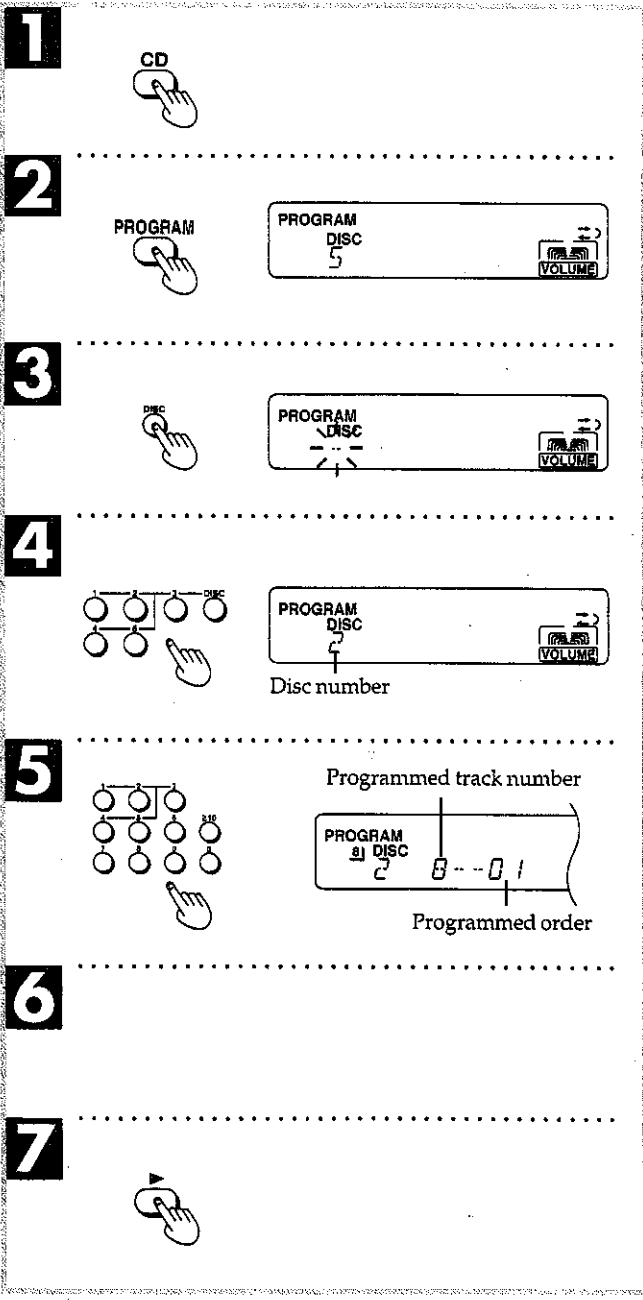

To cancel program play mode:

Press PROGRAM.
"CLEAR" will appear on the display for approximately 1 second and all the programmed tracks will be cancelled.

When "FULL" appears:

The number of programmed tracks is limited to 24. No further tracks can be programmed.

When "--:--" appears:

The total playing time of the programmed tracks has exceeded 99 minutes 59 seconds, or you tried programming a track which is numbered 25 or more, or you tried programming a disc not in playing position. In any case, you can still program and play discs.

You can do the following during program play. \square

- **Check program contents.**
 1. Press CANCEL.
"CANCEL" will light.
 2. Press **◀◀** or **▶▶** on the CD changer. Every time you press one of the buttons, the track and program No. are shown on the display.
 3. After the total playing time appears on the display, press CANCEL. "CANCEL" goes out.
- **Add to the program.**
Repeat steps **3** through **5**.
- **Cancel entries.**
A specific track only:
 - ① Press CANCEL. "CANCEL" will light.
 - ② Press the numeric button(s) of the track you want to cancel, or press **◀◀** or **▶▶** on the CD changer to select the track you want to cancel and then press CANCEL.
 - ③ Press CANCEL once again. "CANCEL" goes out.
 All tracks:
Press PROGRAM, or press **■** while play is stopped.

For your reference:

To program the track you are listening to:
If you press PROGRAM during playback, the program mode will engage and the current playback track will be automatically recorded as program No. 1

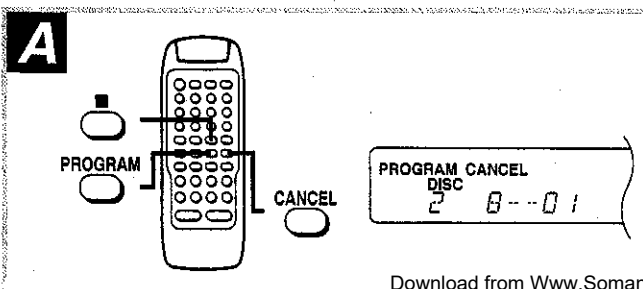

Compact disc operations

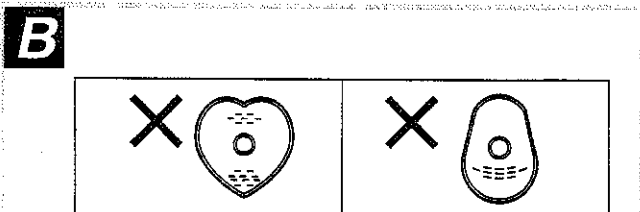
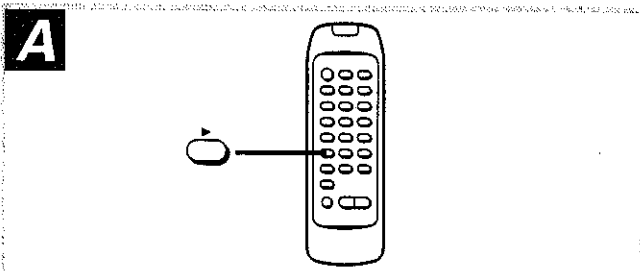
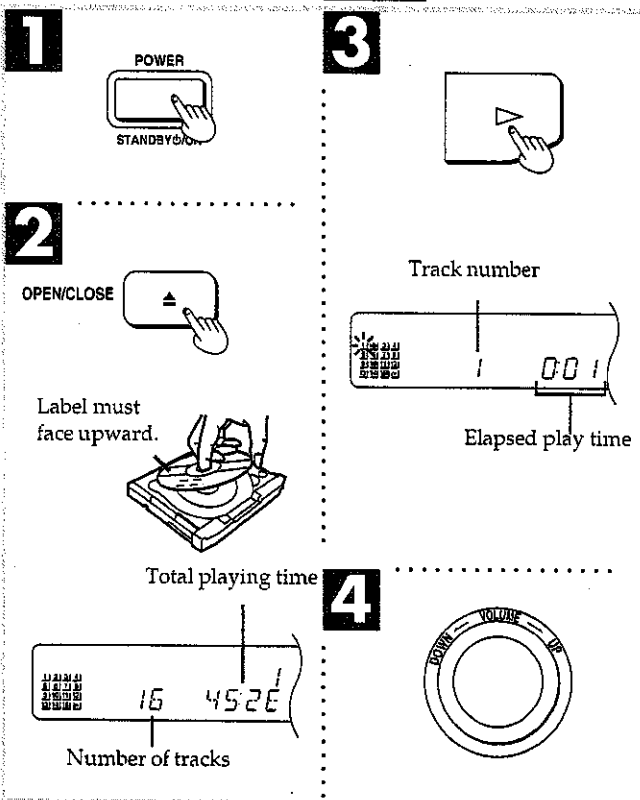
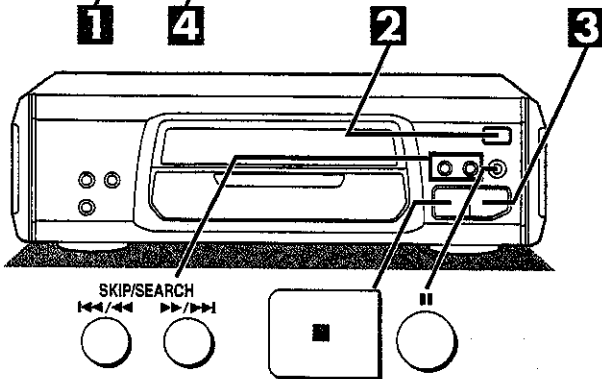

Listening to compact discs

For SC-EH500

Sequential play

- 1** Switch on the power.
- 2** Press **▲ OPEN/CLOSE** to open the tray.
Insert the CD with label facing upward.
Press **▲ OPEN/CLOSE** to close the tray.
When the "CD" input source is selected, total number of tracks and total playing time will appear on the display.
When there are 16 or more tracks on the CD, "▶" will appear.
- Note**
The total playing time displayed when a disc is loaded includes intervals between tracks. This is why sometimes the displayed time is longer than that listed on the CD.
- 3** Press **▷**.
Play will start from the first track on the CD.
Play will stop automatically when the last track on the CD finishes playing.
- 4** Adjust the volume level as you like.

To stop the disc:

Press **■**.

To temporarily stop the disc:

Press **||**. The play indicator flashes green.
To play again, press **▷**.

When "NO DISC" display appears:

It indicates that a CD has not been installed.

About play indicator:

While halted: Lights up orange.
While playing: Lights up green.

For your reference:

If you press **▷** instead of **▲ OPEN/CLOSE** after inserting a CD, the tray will close and play will start directly from track 1.

To search forward/ backward	Hold down during playback. ◀◀/◀ ▶/▶▶ (Backward) (Forward)
To skip forward/ backward	Press. ◀◀/◀ ▶/▶▶ (Backward) (Forward)

Note

During random play, you cannot skip to tracks which have already been played. (page 23)

For your reference:

- During program play or random play, you cannot search-forward/backward over tracks. (pages 23 and 24)
- During program play, skipping is in always in the programmed order, whether forward or backward. (page 24)

One-touch play **⏪**

When the system is OFF, play starts automatically when you press **▶** on the remote control.
Play will start with volume increasing gradually.

Notes

- Do not use CDs with poorly attached labels or stickers. Adhesive protruding from underneath stickers or left over from peeled off stickers can cause the system to malfunction.

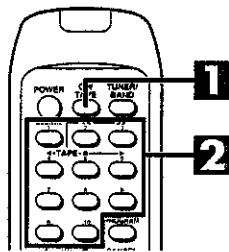
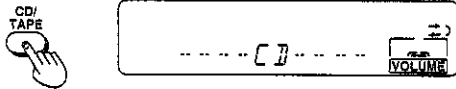
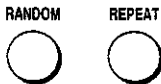
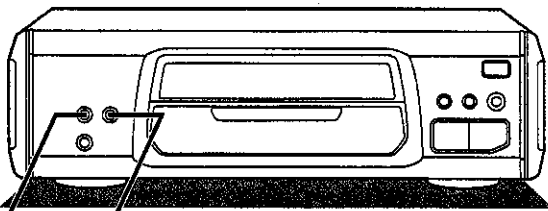
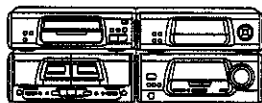
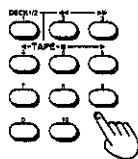
A**1****2****B**

REPEAT

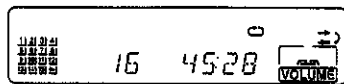
**C**

RANDOM



Listening to compact discs For SC-EH500

Direct access play A

by remote control only

Direct access allows you to start sequential play from a specific track to the last track on the CD.

- 1** Press CD/TAPE to select "CD".
- 2** Press the numeric button(s) to select the desired track number.
Play will start with the track you select.

To select a two-digit track:

Press ≥ 10 and then the two numbers you want within 10 seconds or so.

Repeat play B

This function repeats the play of all tracks.

Press REPEAT before or during play.

"" will light.

To cancel repeat play:

Press REPEAT once again.

"" will go out.

For your reference:

In program play mode (See page 24), the CD player will repeat only the programmed tracks. You can enjoy the same track over and over by programming only one track.

Random play C

Press RANDOM.

"RANDOM" will light, and then random play will start.

Play will stop automatically when all tracks on the CD finish playing randomly.

To cancel random play:

Press RANDOM once again.

"RANDOM" will go out. The CD player resumes the sequential play mode.

For your reference:

In the program play mode (See page 24), the programmed tracks will be played randomly.

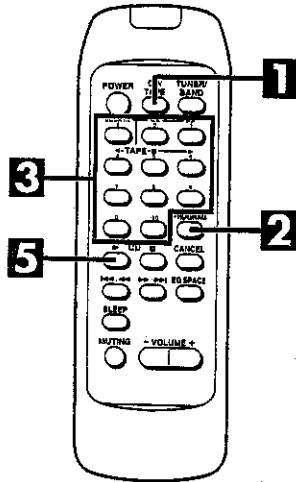

Program play

by remote control only

This function allows you to program up to 24 tracks.

- 1** Press CD/TAPE to select "CD".
- 2** Press PROGRAM.
- 3** Press the numeric button(s) to select the track you want to play in the desired sequence.
To select a two-digit track:
Press ≥ 10 and then the two numbers you want.
- 4** Repeat step **3** until you have programmed all the tracks you want.
- 5** Press **▶**.
Play will start in the programmed sequence.
Play will stop automatically when all the programmed tracks have been played.

To cancel program play mode:

Press PROGRAM.

"CLEAR" will appear on the display for approximately 1 second and all the programmed tracks will be cancelled.

When "FULL" appears:

The number of programmed tracks is limited to 24. No further tracks can be programmed.

When "---:--" appears:

The total playing time of the programmed tracks has exceeded 99 minutes 59 seconds, or you tried programming track which is numbered 25 or more. In any case, you can still program and play discs.

You can do the following during program play. **A**

•Check program contents.

1. Press CANCEL.
"CANCEL" will light.
2. Press **◀◀/▶▶** or **▶▶/▶▶**. Every time you press one of the buttons, the track and program No. are shown on the display.
3. After the total playing time appears on the display, press CANCEL. "CANCEL" goes out.

•Add to the program.

Repeat step **3**.

•Cancel entries.

A specific track only:

- ① Press CANCEL. "CANCEL" will light.
- ② Press the numeric button(s) of the track you want to cancel, or press **◀◀/▶▶** or **▶▶/▶▶** to select the track you want to cancel and then press CANCEL.
- ③ Press CANCEL once again. "CANCEL" goes out.

All tracks:

Press PROGRAM, or press **■** while play is stopped.

For your reference:

To program the track you are listening to:

If you press PROGRAM during playback, the program mode will engage and the current playback track will be automatically recorded as program No. 1.

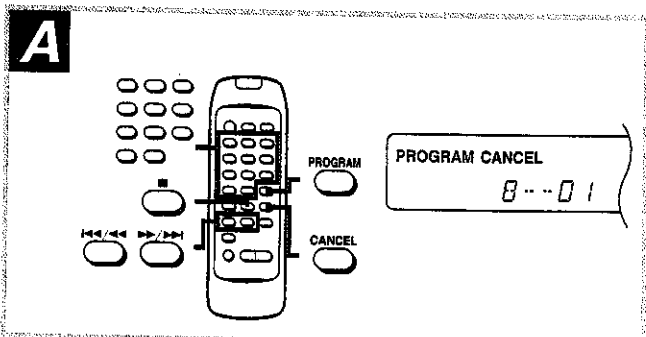
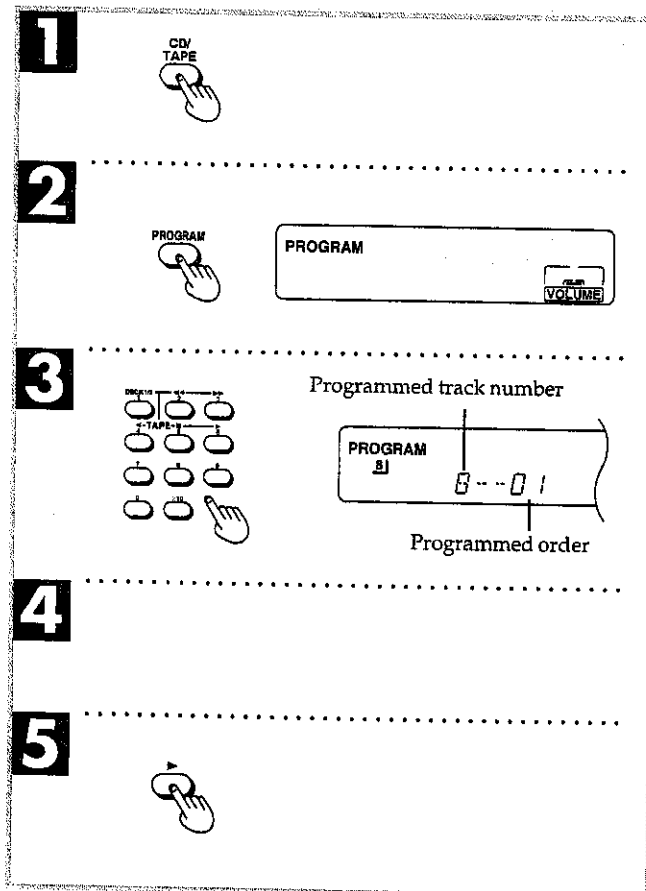

Listening to tapes

Playback

Types of tapes which can be played:

The unit automatically identifies the type of tape.

Normal position/TYPE I	○
High position/TYPE II	○
Metal position/TYPE IV	○

- Both deck 1 and 2 can be used to playback tapes.
- This page shows an example using deck 1.

- 1** Switch on the power.
- 2** Press **▲ OPEN** on deck 1 and insert the tape. Load a tape with the exposed side facing downward. Close the cassette holder.
- 3** To listen to a tape recorded in Dolby B NR: Press **DOLBY NR** and check "DD NR" is displayed. When playing back a tape which was not recorded in Dolby NR, press DOLBY NR so that the indicator goes off.
- 4** Press **REV MODE** to select the reverse mode. Each time you press REV MODE, one of the indicators will appear.
 - ↔: The deck plays one side only, and then stops automatically.
 - ↔↔: The deck plays both sides, and then stops automatically.
 - ↔↔↔: The deck plays both sides 8 times, and then stops automatically.
 When you load tapes into both decks, sequential playback will repeat 8 times (see page 27).
- 5** Press **◀** or **▶**.
 - ▶: The forward side will play.
 - ◀: The reverse side will play.

- 6** Adjust the volume level.

To stop tape playback:

Press **■**.

To change the deck to be used:

Press DECK 1/2 to select the deck you want to play. Deck 1 or deck 2 indicator lights up.

One-touch play **⏪**

When the system is OFF, play starts automatically when you press **◀** or **▶** on the remote control. Play will start with volume increasing gradually.

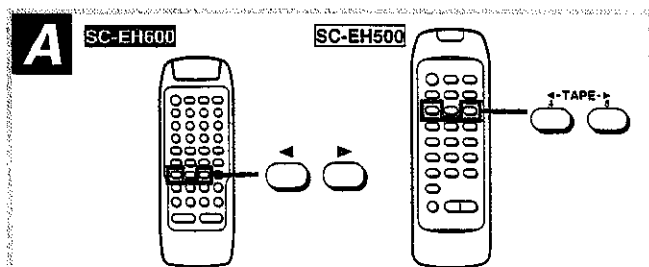
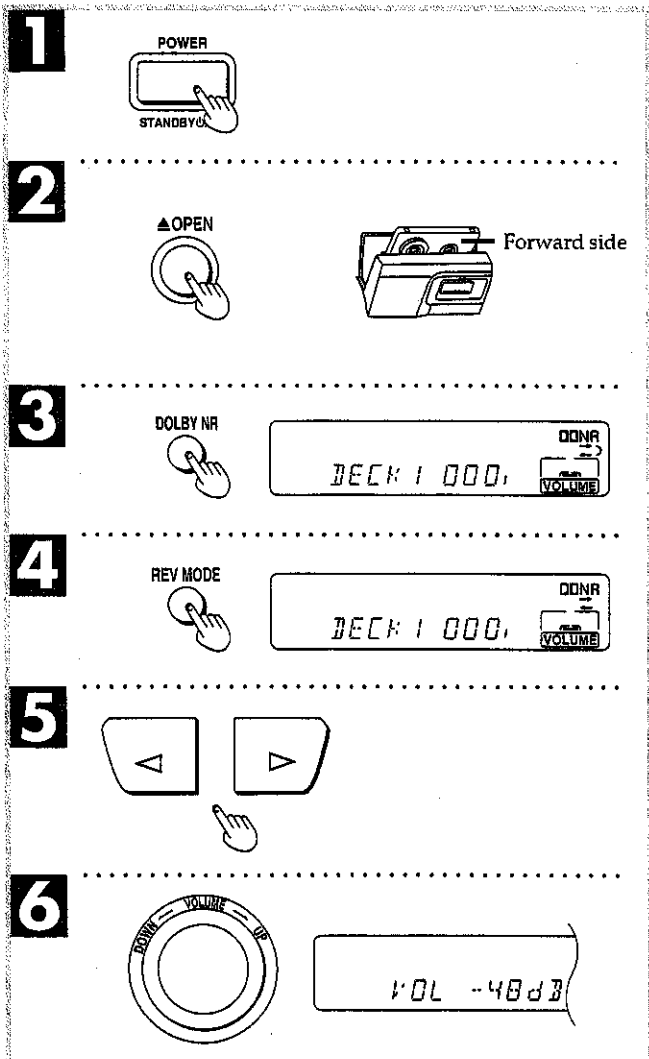
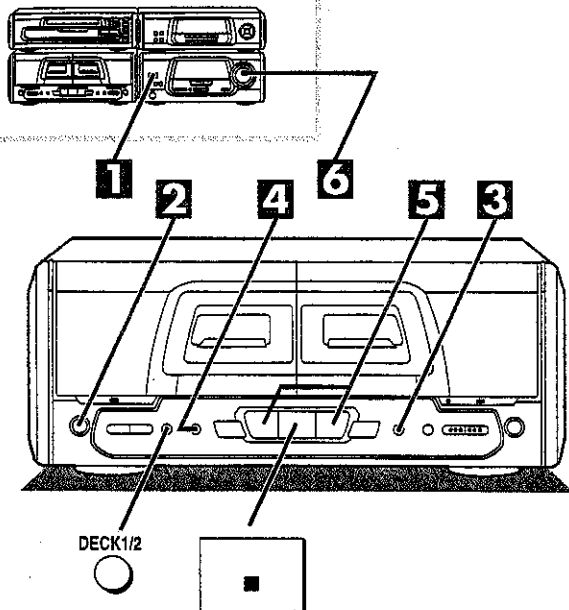

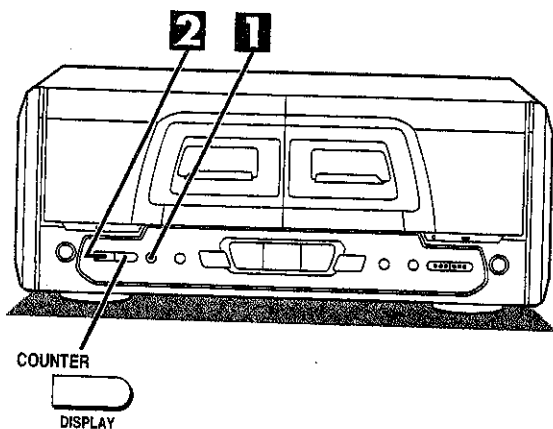
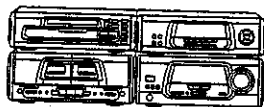
A**1**

DECK 1/2

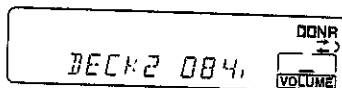
**2**

COUNTER

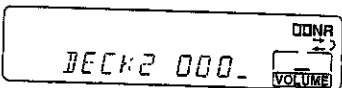
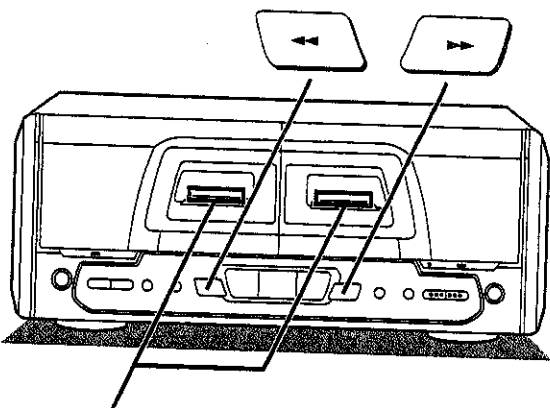
**B**

High speed rewind/fast forward indicator

Listening to tapes

To reset the tape counter

- 1** Press DECK 1/2 to select the deck to be used.
- 2** Press COUNTER RESET. When the tuner or CD mode display shows, the tape counter display will appear for about 1 second.

To reset the tape counter while listening to or recording from CDs or the radio

- 1** Press COUNTER DISPLAY.
- 2** Press COUNTER RESET while the tape counter is being displayed (displayed for approximately 5 seconds).

For your reference:

- When the tape is travelling in the reverse direction, the value displayed on the tape counter will count down. After "000_" is reached, the display will switch to "999_" and then continue counting down.
- It is useful—for example—to reset the counter when recording from the middle of tapes. The number lets you know roughly where you started from.

About the playback indicators:

While halted, fast forwarding, or rewinding:

Lights up orange.

While playing or recording:

Lights up green.

While finding the beginning of a program or recording is on standby:
Flashes green.

To fast forward or rewind the tape

Press ◀◀ or ▶▶ while the tape is in the stop mode.

Tape direction	To rewind	To fast-forward
▶	◀◀	▶▶
◀	▶▶	◀◀

Hi-speed fast-forward/rewind

This cassette deck is designed to roughly double fast-forward/rewind speed automatically.

When you fast-forward from the beginning of the tape or rewind from the end of it, the tape runs at high speed and the high speed rewind/fast forward indicator flashes.

When reaching the end of the tape, the deck automatically drops to normal speed.

For your reference:

- Each deck's play direction is stored in the system's memory.
- The deck may not sometimes make the high-speed rewind/fast-forward from midway through the tape.
- You can fast forward or rewind the tape while you are playing or recording a tape in another deck. Press DECK 1/2 to switch to the non playing deck, and then press ◀◀ or ▶▶. After the above operation, be sure to press DECK 1/2 to reselect the deck in which you are playing a tape.

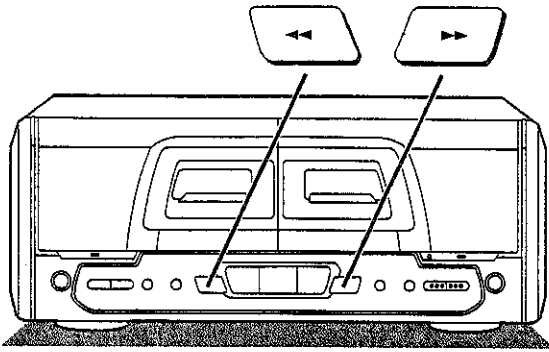
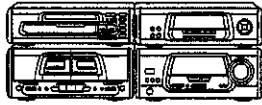
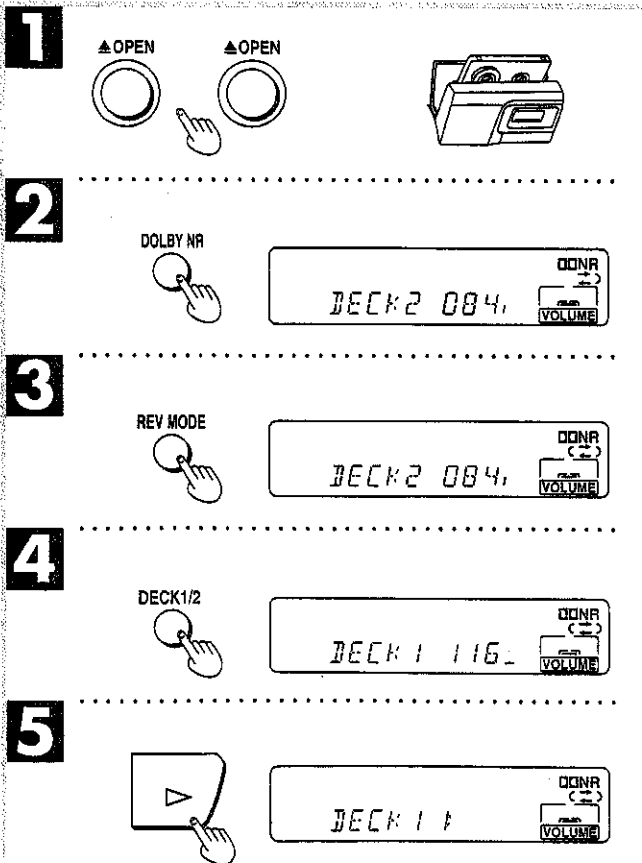
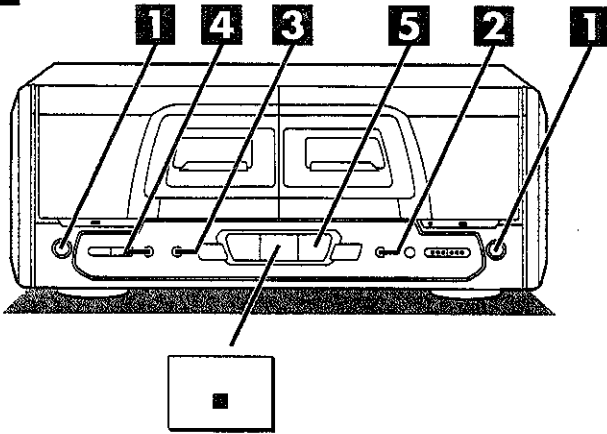
A**B**

Listening to tapes

To find the beginning of a program (TPS: tape program sensor)

Press ◀◀ or ▶▶ while the tape is playing.

If the forward side (▷) is playing:

▶▶: The tape will play from the beginning of the next tune.

◀◀: The tape will rewind to the beginning of the present tune.

Then the tune will play again.

If the reverse side (◁) of the tape is playing:

The reverse operation will take place.

Notes

TPS is the function that searches for the silent passages in a tape program. It may sometimes fail to operate correctly in the following situations:

- When the interval between programs is less than 4 seconds
- When there is a particularly low-level passage in a program (for example, classical music)
- When the program is less than 10 seconds, or when it is less than 10 seconds from the current point to the beginning of the next tune
- When the tape is recorded with fade-ins or fade-outs

Sequential playback among 2 tapes

1 Press ▲ OPEN on decks 1 and 2, and then insert the tapes.

Load with the side that you wish to listen to first facing you in deck 1.

Close the cassette holders.

2 Press DOLBY NR to select ON or OFF.

"□□ NR" appears when the Dolby NR system is on.

3 Press REV MODE to select "↔" mode.

4 Press DECK 1/2 to select deck 1.

The deck 1 indicator will light up.

5 Press ▷.

① Forward side of tape in deck 1

② Reverse side of tape in deck 1

③ Forward side of tape in deck 2

④ Reverse side of tape in deck 2

• After repeating above operation 8 times, the tape will automatically stop.

• You can also start playback from a position other than the forward side in deck 1 (①). In this case, when the reverse side of the tape in deck 2 is finished, the above pattern will be repeated another seven times.

To stop tape playback:

Press ■.

For your reference:

Dolby NR cannot be selected for only one deck. We recommend you use tapes of the same type (Dolby noise reduction).

About priority of the deck:

When you load tapes in both decks, the deck 1 or 2 indicator will light to show which deck you loaded last.

If tapes are loaded in both decks when you switch on the power, the deck 1 indicator will light.

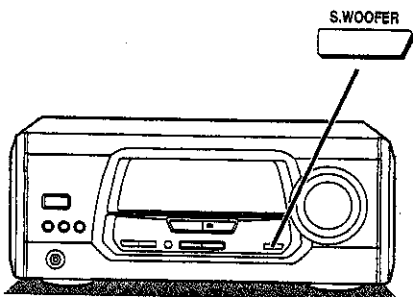
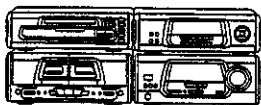

Changing the tone

Boosting the super woofer A

Press **S. WOOFER**.

"S. WOOFER" will light.

•When listening to the sound through the speakers:

Each time you press the button, the level will change as follows.

MID (medium) → MAX (high) → Light off (OFF)

Note

When S. WOOFER is on and either MID or MAX are not displayed then when S. WOOFER is pressed, the current level will be displayed. Pressing the button a second time will change the level.

•When listening to the sound through the headphones:

Each time you press the button,

ON ↔ OFF

To cancel, press S. WOOFER to select OFF.

("S. WOOFER" will go out.)

Note

You cannot record with S. WOOFER effect.

"S. WOOFER" is only effective on sounds which can be heard through the speakers or headphones.

Using the internal sound quality B

Press **PRESET/MANUAL** to select the desired mode.

Each time you press PRESET/MANUAL, EQ and SPACE modes will be switched as follows.

HEAVY → CLEAR → HALL → MANUAL

- 1 **HEAVY:** Use to add "punch" to rock and other music.
- 2 **CLEAR:** Use to clarify the treble range of jazz, etc.
- 3 **HALL:** Use to impart a deep bass and spread which will make you feel as if you were in a large concert hall.
- 4 **MANUAL:** Refer to the "Finer sound quality changes" section on page 29.

To cancel the EQ SPACE effect

Press EQ SPACE ON/FLAT to select "FLAT".

Notes

- Recordings cannot be made in the HEAVY, CLEAR, HALL or MANUAL modes.
- Recording during use of sound quality operation will cause the "HEAVY", "CLEAR", "HALL" and "MANUAL" indicators to disappear and light again when recording is completed.

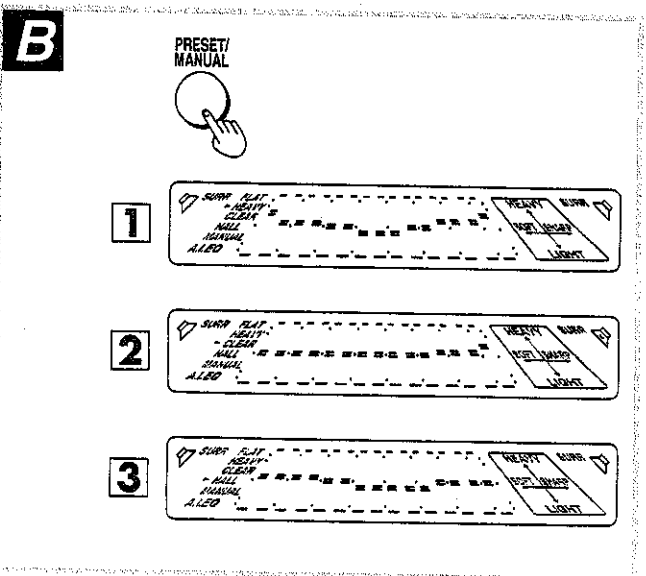
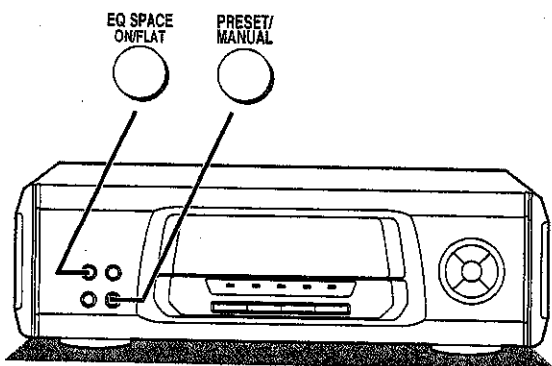
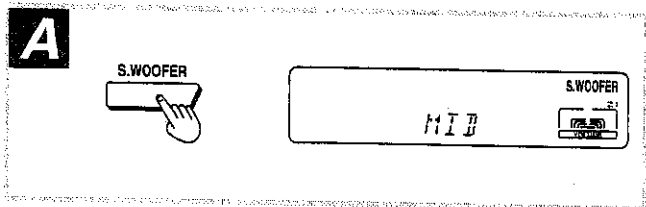

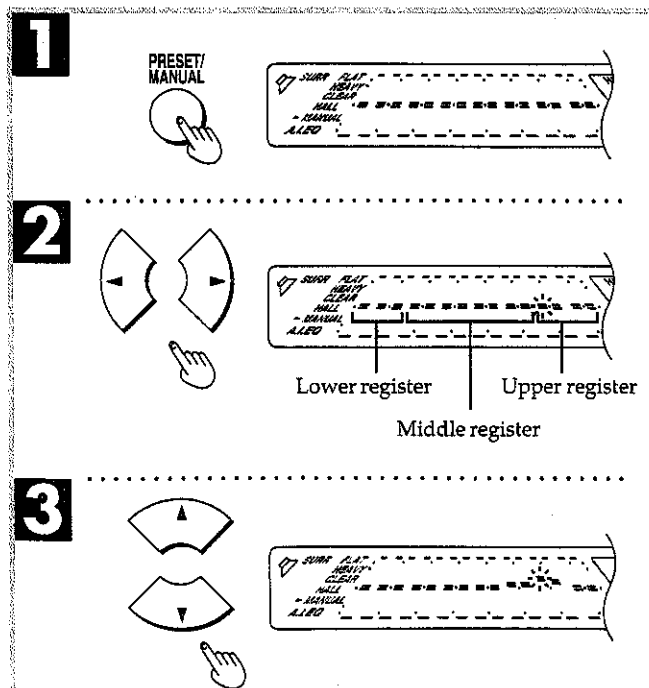
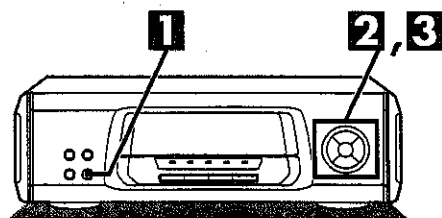
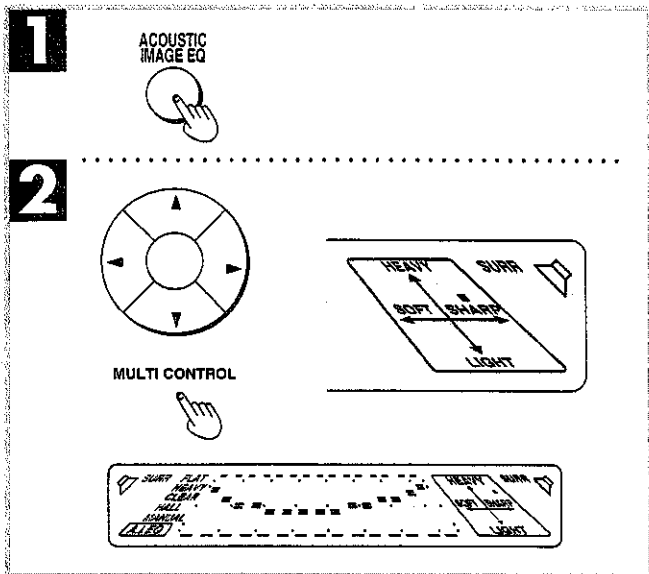
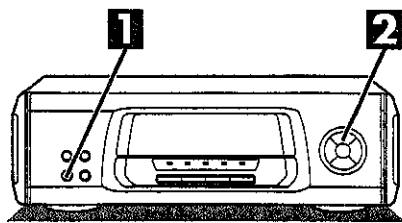
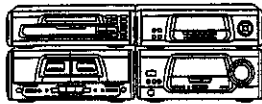

Changing the tone

Using the acoustic image EQ

This function allows easy creation of sounds closer to what you imagine.

The figure shows an example where the sound quality has been adjusted to HEAVY level 2 and SHARP level 3.

- 1 Press **ACOUSTIC IMAGE EQ**.
- 2 Press the **▲ ▼ ◀ ▶** buttons to move the cursor to the desired music image.

- HEAVY (▲):** When a heavier sound is desired
LIGHT (▼): When a lighter sound is desired
SOFT (◀): When a softer sound is desired
SHARP (▶): When a sharper sound is desired

To cancel the **ACOUSTIC IMAGE EQ** effect
 Press **EQ SPACE ON/FLAT** to select "FLAT".

Notes

- Sounds can be made to fit a total of 36 images.
- The resulting adjustment is automatically stored in memory. When the **ACOUSTIC IMAGE EQ** is pressed again, the image last selected is automatically selected.
- Recording cannot be made in the acoustic image EQ mode.

Finer sound quality changes

Finer sounds can be created by selecting **MANUAL**.

- 1 Press **PRESET/MANUAL** to select **MANUAL**.
- 2 Press **◀ ▶** to select the desired register.
 - ▶: Upper register
 - ◀: Lower register
- 3 Press **▲ ▼** to adjust the register level.
 - ▲: Increasing the register level
 - ▼: Decreasing the register level

For your reference:

Upper register: includes pipes, strings, cymbals and triangles

- Increasing the upper register: mellows pipes and strings, adds precision and glitter
- Decreasing the upper register: quiets music, rids music of its "stretch"

Middle register: vocals (voice)

- Increasing the middle register: gives strength and punch to music brings voices forward, brightens sound
- Decreasing the middle register: quiets music, pulls voices back, softens intense sounds

Lower register: includes bass and drums

- Increasing the lower register: stabilizes heavy and low sounds, swells low sounds
- Decreasing the lower register: decreases noise in lower sounds, reduces muffled sounds

Notes

- The resulting adjustment is automatically stored in memory. When the **MANUAL** mode is selected again, the sound quality last selected is automatically played back.
- The register can be manually adjusted at 5 individual points along the 100 Hz–10 kHz frequency range.

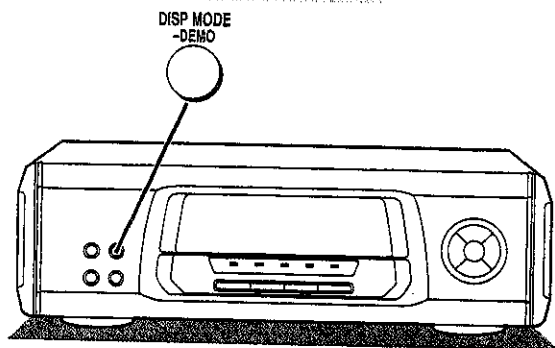
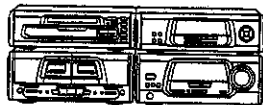
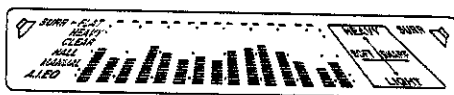
ADISP MODE
-DEMO**1****2****3**

Concerning the display

The sound processor shows the level of each sound range with the three types of display described belows. **A**

Press **DISP MODE/-DEMO** momentarily.

The spectrum display will change as follows.

1 Normal display

This display indicates the strength of the sound in each tonal range.

2 Peak-hold display

The peak sound value of each sound range is held on the display for about one second after occurs.

3 Aurora display

The peak sound value of each sound range is displayed in inverted form.

For your reference:

The demonstration function starts when **DISP MODE/-DEMO** is held down.

To mute the volume **B**

This feature is convenient when you have a telephone call, etc.

by remote control only

Press **MUTING**.

"MUTING" will light.

Sound remains muted when you put the stereo on standby.

To cancel, press **MUTING** once again. ("MUTING" goes out.)

To cancel from the tuner/amplifier, reduce the volume level to the minimum position (--- dB) and then reset to the desired volume.

B

SC-EH600

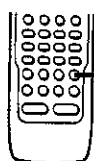

MUTING

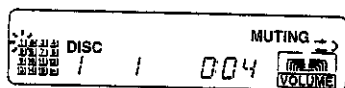

SC-EH500

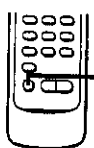

MUTING



Enjoying sound with DOLBY PRO LOGIC For SC-EH600

By combining front, center and surround speakers, you can enjoy the SURROUND mode which conveys a feeling of presence or the 3 STEREO mode which conveys a feeling of orientation.

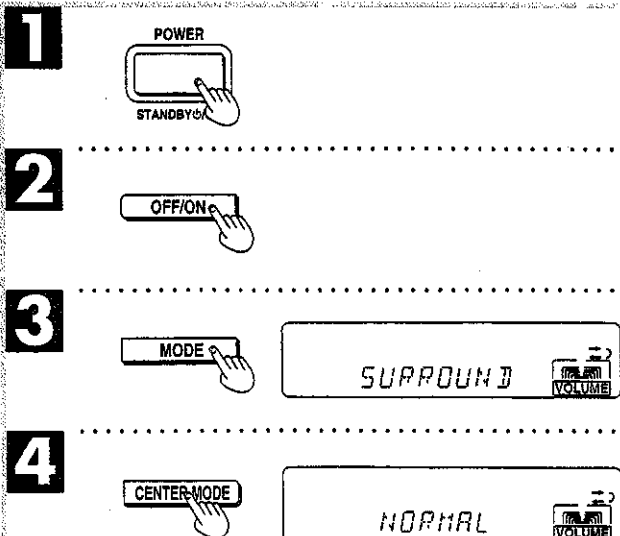
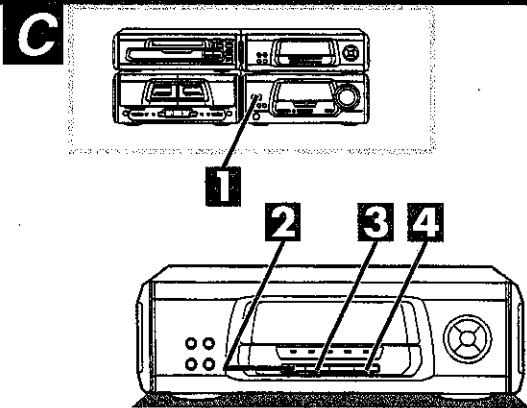
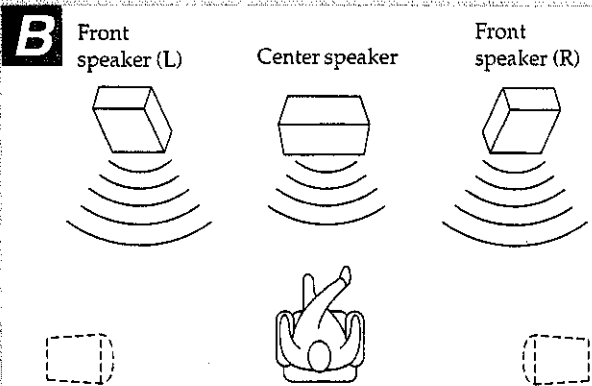
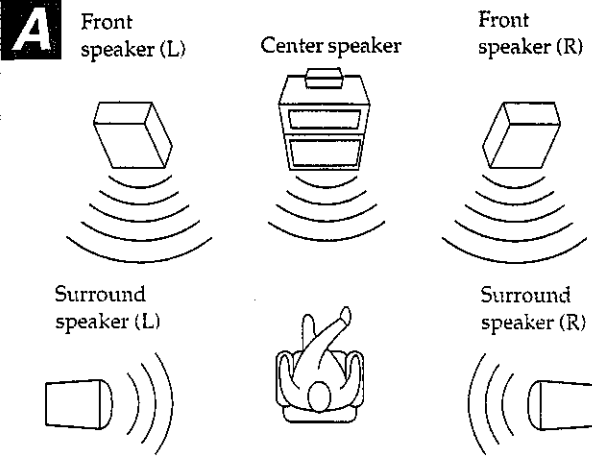

SURROUND

By reproducing the feeling of depth and movement of sound, video software or compact discs recorded with DOLBY SURROUND, provide the listener with the sensations of a movie theater.

To enjoy SURROUND, be sure to connect the surround speakers.

3 STEREO

You can enjoy audio/video sources with clear sound, more presence and enhanced orientation. 3 STEREO can be used with sources not recorded in DOLBY SURROUND.

To enjoy 3 STEREO, be sure to connect the center speaker.

Manufactured under license from Dolby Laboratories Licensing Corporation.
DOLBY, the double-D symbol and "PRO LOGIC" are trademarks of Dolby Laboratories Licensing Corporation.

Setting the center mode

For Dolby Pro Logic systems, center mode setting is necessary to play back bass sounds effectively. Set the center mode in accordance with the size of your center speaker.

- 1 Switch on the power.
- 2 Press DOLBY PRO LOGIC OFF/ON to select ON.
- 3 Press MODE to select "SURROUND" or "3 STEREO".
Each time you press the button, the display will change as follows:
SURROUND → 3 STEREO
The selected mode's indicator lights.
- 4 Press CENTER MODE to select "NORMAL" mode.
Each time you press the button, the display will change as follows:
NORMAL → WIDE → PHANTOM
The selected mode's indicator lights.

Note

"PHANTOM" will not be displayed when you select "3 STEREO" in step 3.

NORMAL:

When the center speaker is smaller than the front speakers

WIDE:

When the center speaker is the same size or larger than the front speakers

PHANTOM: SURROUND only

When no center speaker is connected

Note

In the PHANTOM mode, the sound which would have been sent to the center speaker will be divided equally between both the left and right front speakers.

Enjoying sound with DOLBY PRO LOGIC

For SC-EH600

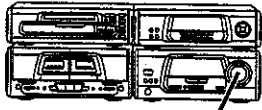

4

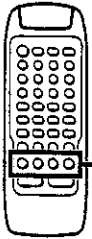

5

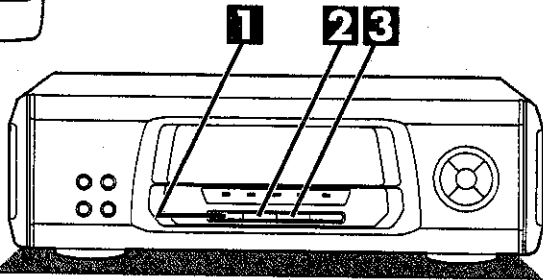

1

2 3

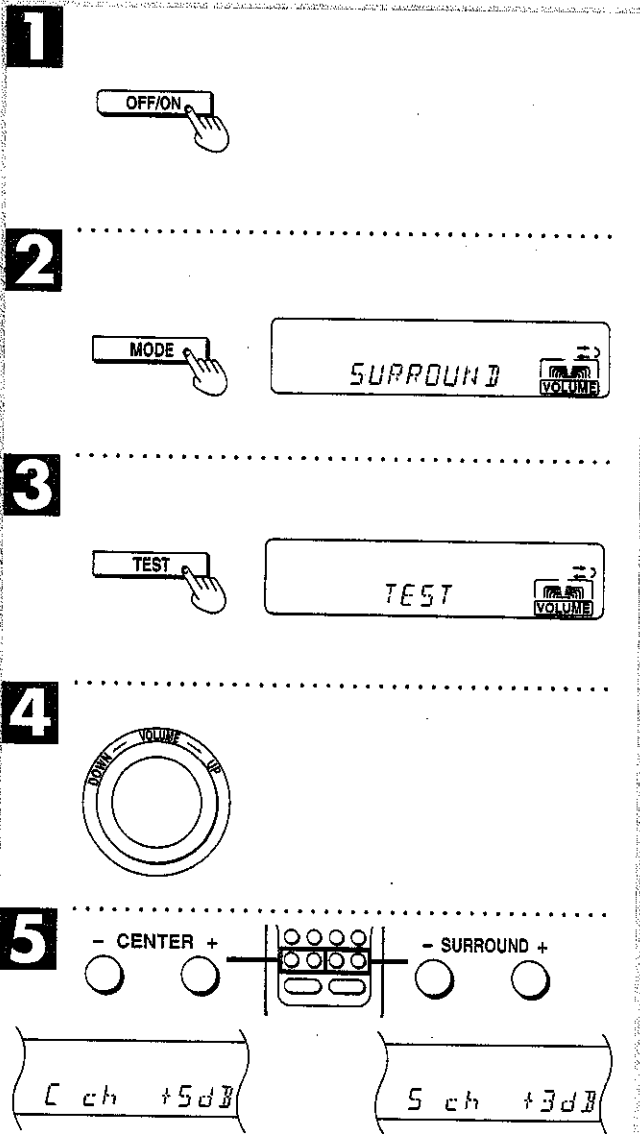

Adjusting speaker output level

In order to reproduce the movement of the sound and its clear orientation, it is important to adjust the output level of each speaker. Adjust output to the correct levels while listening to the test signal.

1 Press DOLBY PRO LOGIC OFF/ON to select ON.

2 Press MODE to select "SURROUND" or "3 STEREO".

Each time you press the button, the display will change as follows:

SURROUND → 3 STEREO

3 Press TEST to output a test signal.

The test signal is emitted in the following order:

For SURROUND mode

Front speaker (left) → Center speaker

Surround speakers (left, right) ← Front speaker (right)

Note

The test signal is not emitted from the center speaker when the center mode is on PHANTOM.

For 3 STEREO mode

Front speaker (left) → Center speaker → Front speaker (right)

4 Turn VOLUME to set the volume level normally used for enjoying the source.

5 Press CENTER (–) or (+) or SURROUND (–) or (+) on the remote control to adjust the output level balance.

Adjust the output level of each speaker from the listening position until they are all identical.

Output levels can be varied within a range of ± 12 dB with front speaker output level serving as the zero point.

Notes

- The test signal is output only by the speaker you are now adjusting and does not repeat the sequence until adjustments are complete.
- Remember you cannot adjust the output level of the surround speakers if you selected the 3 STEREO mode in step 2.

To stop the test signal:

Press TEST.

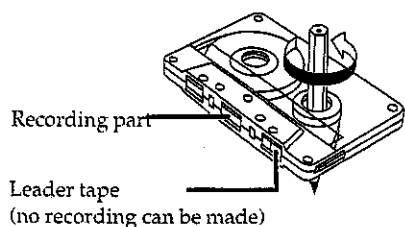
A

Before recording

DECK 2 only

Types of tapes which can be recorded

The unit automatically identifies the type of tape.

Normal position/TYPE I	<input type="radio"/>
High position/TYPE II	<input type="radio"/>
Metal position/TYPE IV	<input type="radio"/>

How to advance the leader tape

A

Wind the leader tape forward so that recording can start as soon as you press the button. This is not necessary if one-touch editing from CDs.

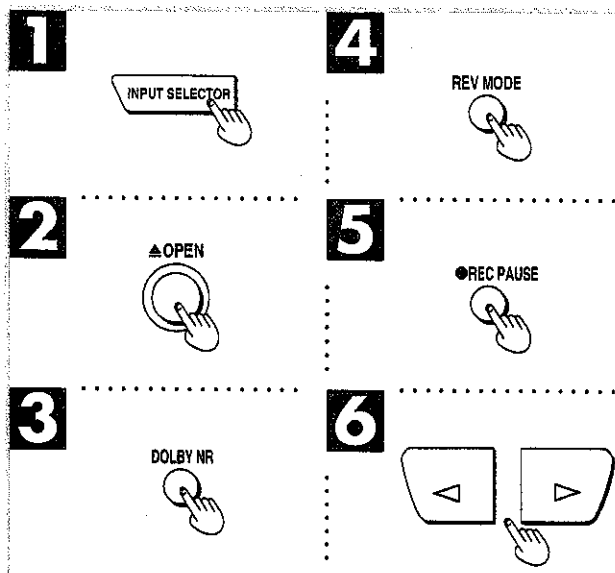
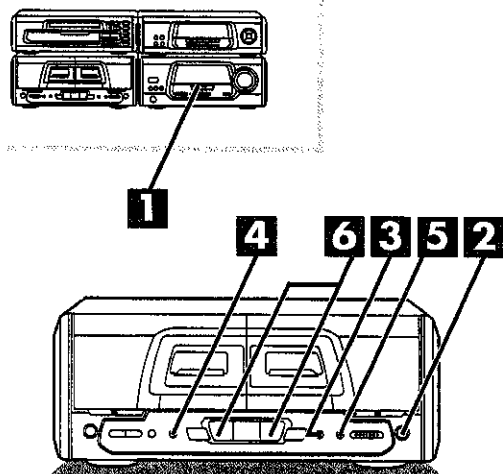
B

About the Dolby noise-reduction system

The Dolby noise-reduction system is designed to effectively reduce the annoying high-frequency "hissing" noise typical of cassette tapes. During recording, the system functions to increase the high-frequency sound level, and then, during playback, that same portion is weakened to bring it back to the previous level. This unit is equipped with the Dolby B NR-type.

Dolby B-type noise reduction:

Noise is reduced to about one-third.

Use this system when playing back tapes recorded by the Dolby-B noise-reduction system, such as prerecorded music tapes, etc.

Dolby noise reduction manufactured under license from Dolby Laboratories Licensing Corporation. "DOLBY" and the double-D symbol  are trademarks of Dolby Laboratories Licensing Corporation.

Volume and sound quality in recording

Changes to volume or sound quality are not recorded on tapes at all.

To erase recorded sounds

B

- 1** Press INPUT SELECTOR on the tuner/amplifier to select "TAPE".
- 2** Insert the recorded tape into deck 2.
- 3** Press DOLBY NR so that the Dolby NR indicator is off.
- 4** Press REV MODE to select reverse mode.
- 5** Press ● REC PAUSE.
REC PAUSE indicator will light.
- 6** Press ◀ or ▶, whichever side you want to erase.

Your attention is drawn to the fact that recording pre-recorded tapes or discs or other published or broadcast material may infringe copyright laws.

Recording from radio broadcasts

DECK 2 only.

Preparation:

Advance the tape to a point from where recording can start immediately.

- 1** Switch on the power.
- 2** Press **▲ OPEN** on deck 2 and insert the tape with the exposed part of the tape facing downward.
Close the holder.
- 3** To record in Dolby B NR:
Press **DOLBY NR** and check "NR" is displayed.

- 4** Press **REV MODE** to select the reverse mode.
 - ⇄: One side will record, and then the tape will stop automatically at the end of the tape.
 - ⇄⇄: Both sides will record (forward side → reverse side), and then the tape will stop automatically at the end of the tape.
 - ⇄⇄⇄: Same as above (When you press ● REC PAUSE, "⇄⇄" will be automatically switched over to "⇄⇄⇄").

- 5** Tune in the desired station.
See page 15.

- 6** Press ● **REC PAUSE** to put the cassette deck into the recording standby mode.
REC PAUSE indicator will light.
The playback indicators < or > will start flashing.

- 7** Press < or > to start recording.
 - >: To begin recording from the forward side.
 - <: To begin recording from the reverse side.

To stop recording:

Press ■.

To display the tape counter while recording:

Press **COUNTER DISPLAY**.

The tape counter will be displayed for approximately 5 seconds. This is a useful way for knowing what point of the tape you're at.

To cut an unnecessary part while recording:

1. Press ● **REC PAUSE**.

The cassette deck will go into the recording standby state.

2. To resume recording, press < or >, whichever playback indicator is flashing.

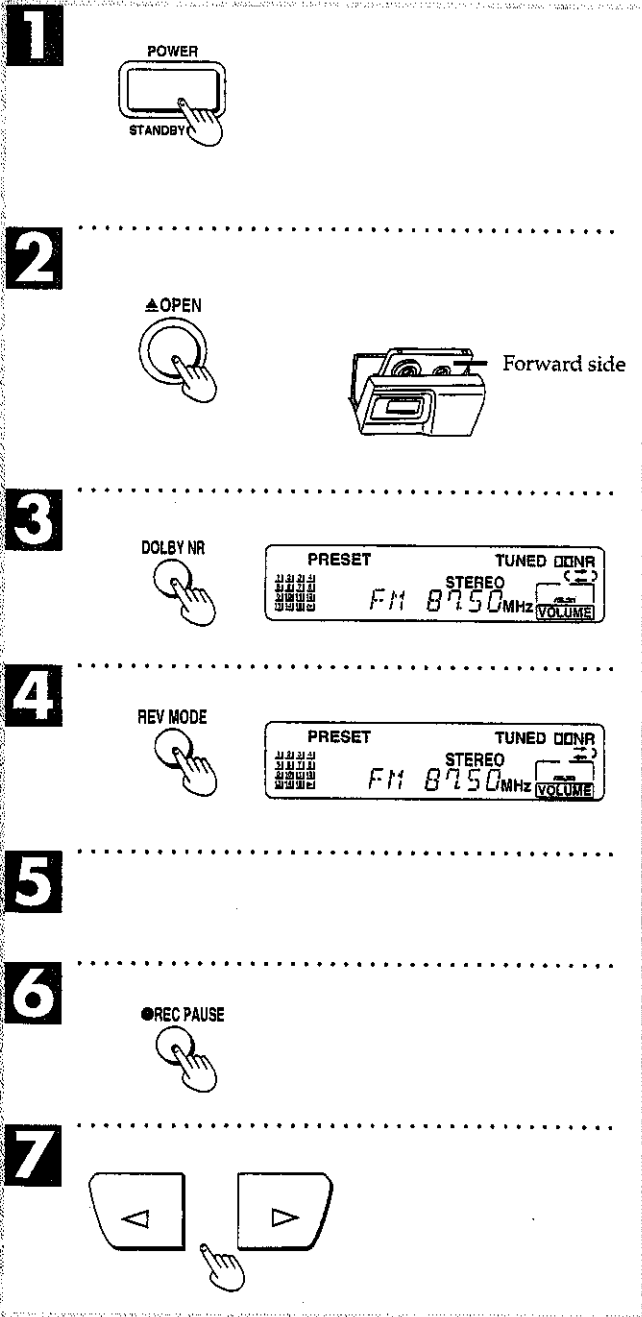
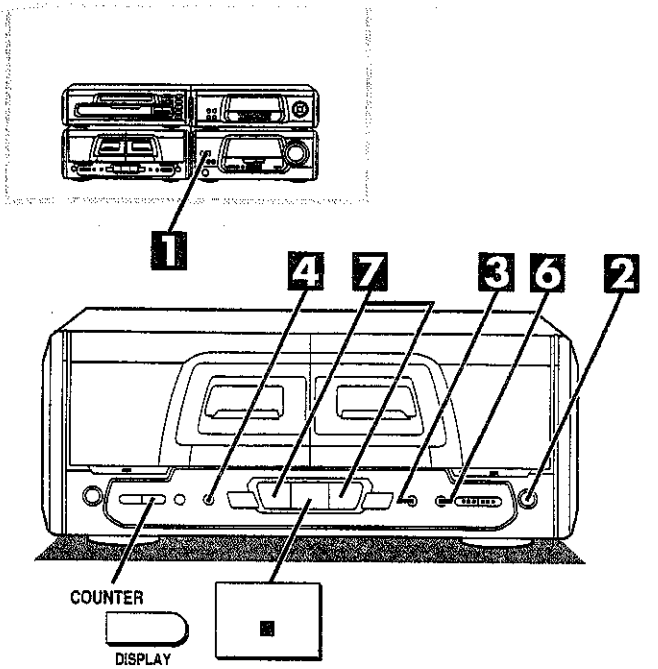

A

When recording from only one CD

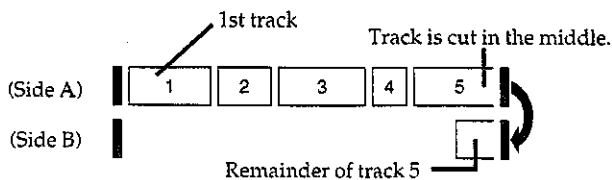

When recording from 2 to 5 discs

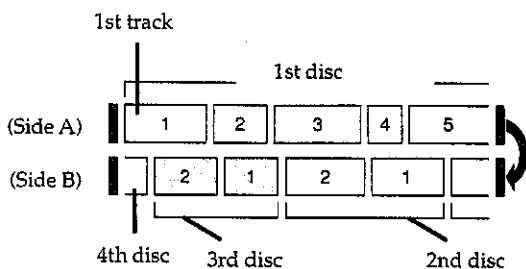
**B**

When recording from only one CD

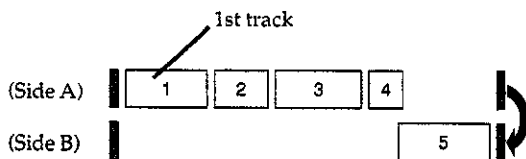

When recording from 2 to 5 discs

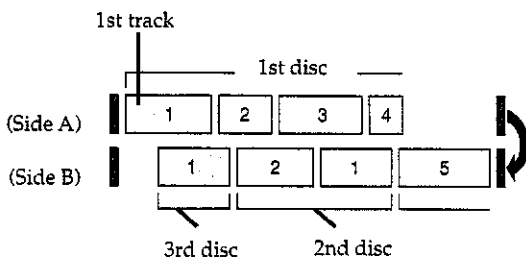

Recording from compact discs

For SC-EH600

DECK 2 only

There are 2 ways to record from compact discs, normal recording and one-touch editing.

Normal recording **A**

In normal recording, no blank space is left at the end of side A. But, this means a track will be cut off in the middle when the end of the side is reached. This method can also be used to record onto a tape from a desired point halfway through one side, or to record from programmed CDs.

One-touch editing [AI EDIT] **B**

The tape deck automatically reads the length of the loaded tape, and then calculates which tracks go on which side of the tape so that no track is cut in the middle when the tape reaches either end.

Recording will begin from the first track of the disc shown on the display. It will continue through the last track on disc 5 and will then stop automatically.

One-touch editing operation:

1. The cassette deck will fast-forward and rewind to measure its length.
2. The cassette deck will advance the tape beyond the leader tape, and then stop.
3. The CD changer assigns tracks to tape side A and B, and displays the result. In addition to the above information, the remaining time of tape side A and B will be displayed.
4. Actual recording starts.
5. When the first CD has been recorded, the deck will start recording the next CD if there is enough room on the tape. If so, "LINK" will appear on the display.

Notes

- Use a tape of under 99 minutes.
- You cannot edit-record tracks numbering higher than 24.
- In one-touch editing, you cannot record from programs that contain selections from two or more discs.

Recording onto left over space on tapes (LINK):

After the edit-recording of loaded CDs have finished, you can subsequently edit-record other CD(s) on the remaining blank portion of the tape.

This function is convenient when recording from 8 cm CDs successively.

For your reference:

It is better to use a tape slightly longer than the CD playing time when recording.

Recording from compact discs

For SC-EH600

Normal recording

- 1** Switch on the power.
- 2** Press **▲ OPEN** on deck 2, and then insert the tape with the exposed part of the tape facing downward.
Close the holder.
- 3** To record in Dolby B NR.
Press **DOLBY NR** and check "□□ NR" is displayed.
- 4** Press **REV MODE** to select the reverse mode.
 - ↔: One side will record, and then the tape will stop automatically at the end of the tape.
 - ↔>: Both sides will record (forward side→reverse side), and then the tape will stop automatically at the end of the tape.
 - ↔<: Same as above (When you press ● **REC PAUSE**, "↔<" will be automatically switched over to "↔>").
- 5** Set the tape travel direction.
To change the tape travel direction, first press < or > on the cassette deck, then ■.
>: Recording from the forward side
<: Recording from the reverse side
- 6** Insert CDs in the trays.
(For details, see page 18.)
- 7** Press ● **REC PAUSE** to put the cassette deck into the recording standby mode.
REC PAUSE indicator lights.
The playback indicators < or > will start flashing.
- 8** Press > on the CD changer.
Recording will begin from the first track of the disc shown on the display.
To record from disc 1, press DISC 1.

Approximately 4 seconds after the CD finishes playing, the cassette deck will automatically put recording on standby.

To stop recording:

- **To add a 4 second silent interval before stopping**
Press ■ on the CD changer.
The cassette deck will go into the recording standby state.
- **To stop recording without a silent interval**
Press ■ on the cassette deck.
The CD changer does not stop.

To record programmed tracks **A**

- ① Perform steps **1**–**6** above, and then press CD on the remote control.
- ② Press PROGRAM on the remote control.
- ③ Press DISC on the remote control.
- ④ Select the CD from the remote control with buttons 1–5.
- ⑤ Select the track number from the remote control with the numeric button(s).
- ⑥ Repeat steps ③ through ⑤ until all desired tracks are programmed (max. 24 tracks).
- ⑦ Perform above steps **7** and **8**.

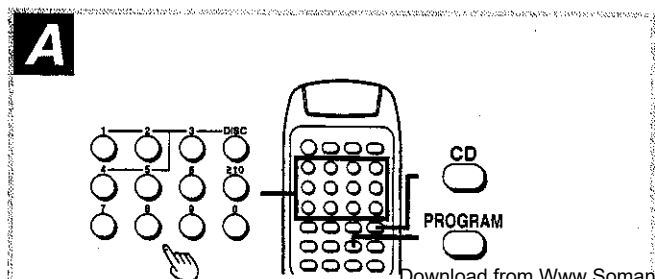
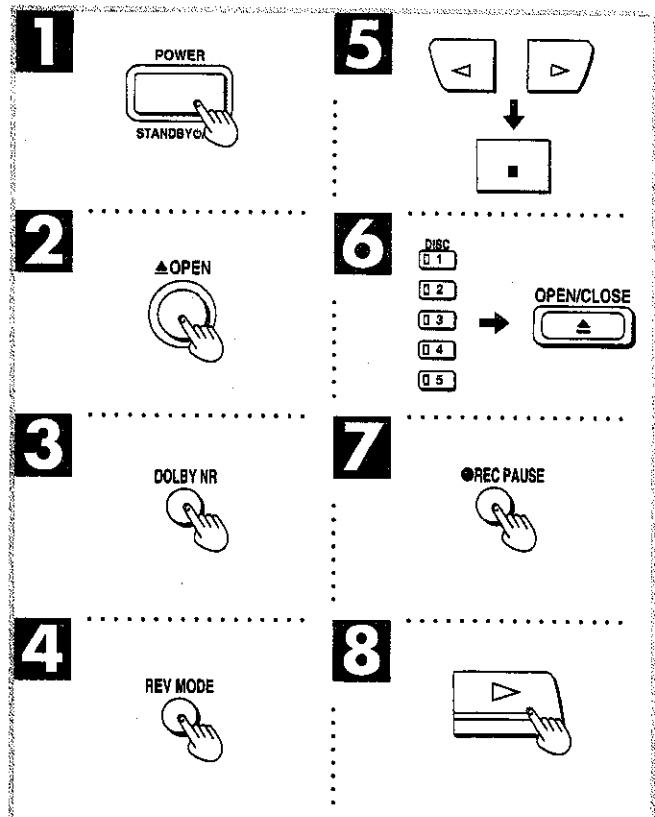
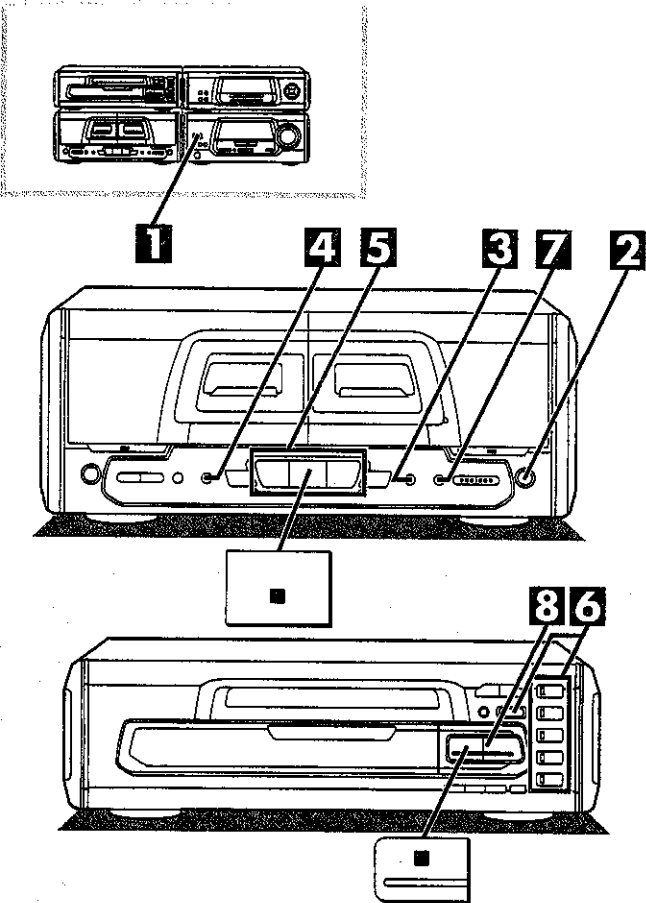

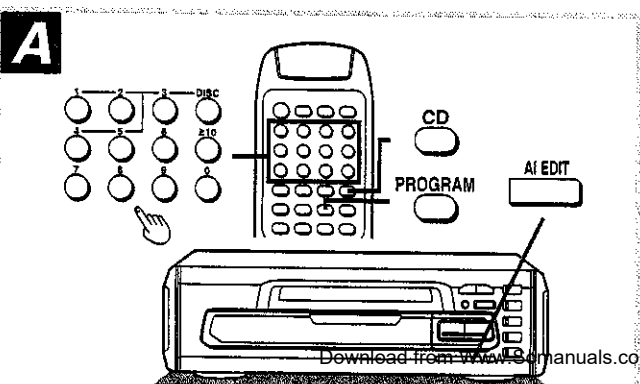
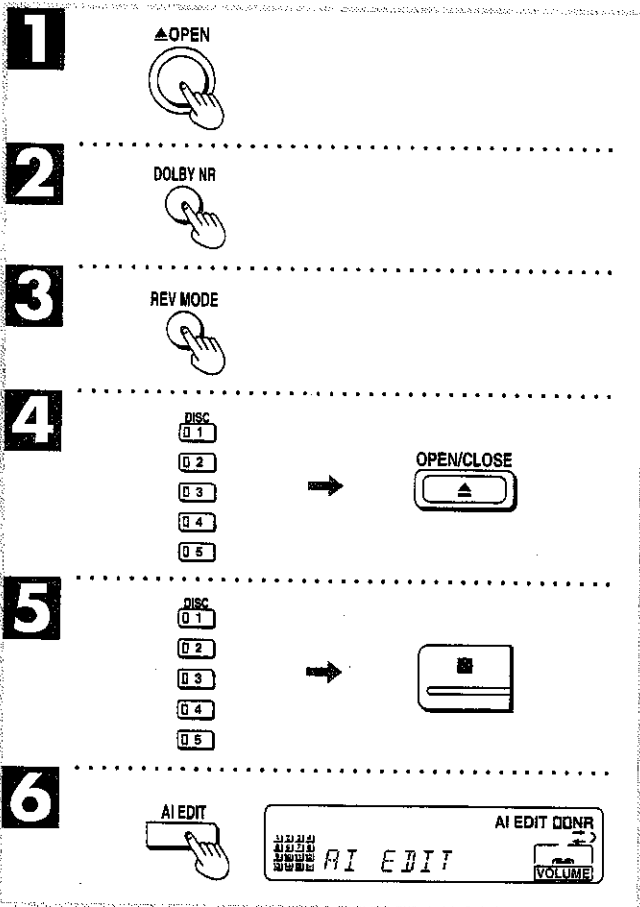
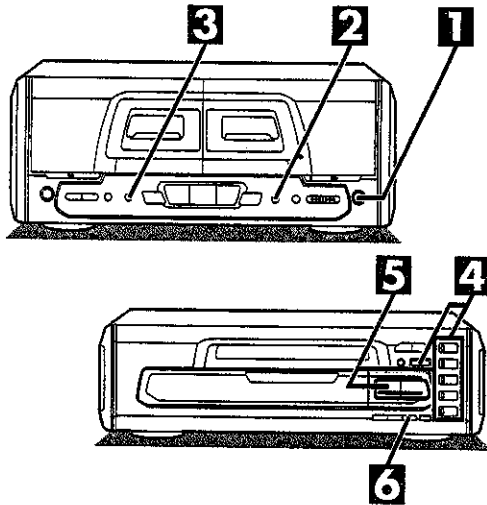
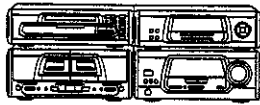

Recording from compact discs

For SC-EH600

One-touch editing

Note

One-touch editing is designed to record from disc 1 all the way through to disc 5. If you want to record just one CD, set it in tray 5.

1 Press **▲ OPEN** on deck 2, and then insert a tape.
Close the holder.

2 To record in Dolby B NR.
Press **DOLBY NR** and check "□□ NR" is displayed.

3 Press **REV MODE** to select the reverse mode.
 ⇄: One side will record, and then the tape will stop automatically at the end of the tape.
 ⇄⇄: Both sides will record (forward side→reverse side), and then the tape will stop automatically at the end of the tape.
 ⇄⇄⇄: Same as above (When you press AI EDIT, "⇄⇄⇄" will be automatically switched over to "⇄⇄").

4 Insert CDs in the trays.
(For details, see page 18.)
Recording will begin from the first track of the disc shown on the display.

5 Specify the disc (DISC 1-5) you want to start recording from. Then, press **■** on the CD changer.

6 Press **AI EDIT**.
The deck will rewind the tape and recording will start. In the meantime, "AI EDIT" will scroll across the display from right to left. However, it will take a moment for recording to actually begin.

To stop one-touch editing:

Press **■** on the cassette deck.
The CD changer also stops.
"EDIT OUT" will scroll across the display from right to left.

When tracks are allotted to side B:

After recording the allotted tracks on side A, the cassette deck will continue recording on side B and will make a blank portion on side A in order to measure the proper length of the tape.

To edit-record programmed tracks

Note

In one-touch editing, you cannot record from programs that contain selections from two or more discs.

- ① Perform steps **1-4** above, and then press CD and PROGRAM on the remote control.
- ② Select the disc you want to record with DISC and the numeric buttons (1-5).
- ③ Select the track number from the remote control with the numeric buttons.
- ④ Repeat step ③ until all desired tracks are programmed (max. 24 tracks).
- ⑤ Press AI EDIT. Recording will begin.

After edit-recording has finished:

The tape deck automatically puts recording on standby. In the meantime, if LINK flashes on the display, there is enough space on the tape to continue recording from another CD (see page 20).

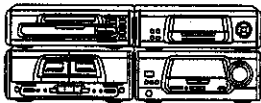

Recording from compact discs

For SC-EH600

Recording onto left over space on tapes (LINK)

You can link up another CD when "LINK" flashes after editing a CD.

1 Press ▲ OPEN/CLOSE to replace the CD with another one.

The tray of the last disc (disc 5) will open. Load the new CD in there.

Note

If you were recording programmed tracks, the tray with the disc you were recording from will open.

2 Press ▷.

Linking will start.

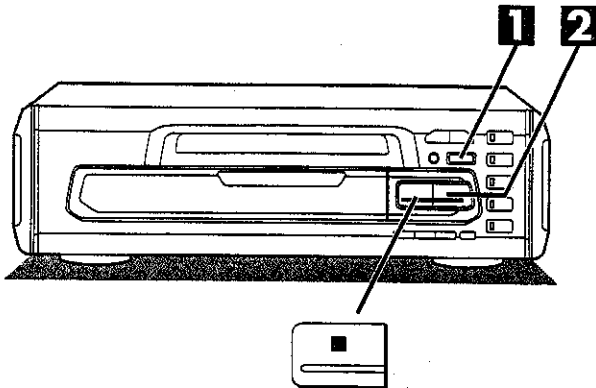

To continue linking tracks:

Repeat steps 1 and 2.

As long as there is space on the tape to record, when the recording finishes, the cassette deck will put linking on standby.

To cancel the LINK function:

Press ■ on the CD changer.

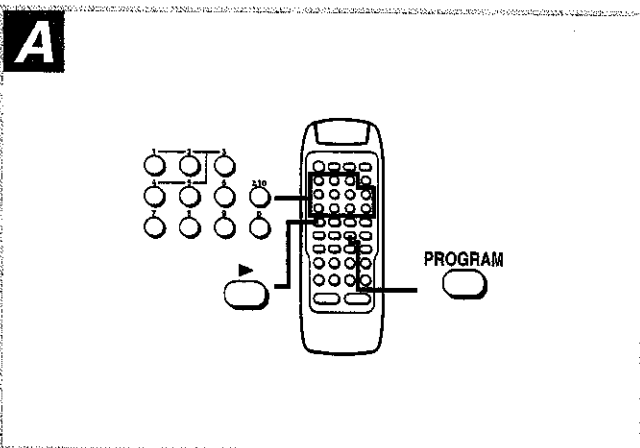
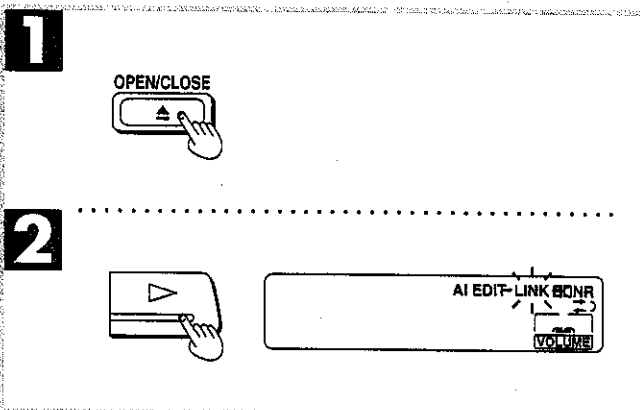

Linking programmed tracks A

- ① Perform step 1 above, and then press PROGRAM on the remote control.
- ② Select the track number from the remote control with the numeric button(s).
- ③ Repeat step ② until all desired tracks are programmed (max. 24 tracks).
- ④ Press ▷. Linking will begin.

Notes

- When recording from a programmed CD other than disc 5, if you press the ▲ OPEN/CLOSE button, the tray with the programmed CD will open/close.
- When the display shows "0:00", you cannot record from another CD. Press ■ on the CD changer.
- If the time remaining on the tape is shorter than the length of a track to be recorded, you cannot record a track. Replace with a track shorter than the time remaining on the tape or press ■ on the CD changer.

A

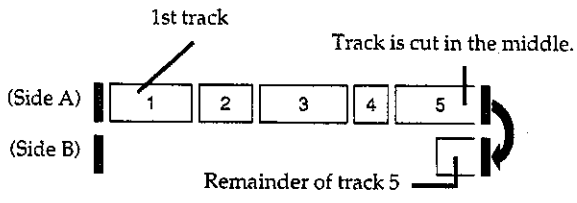

B

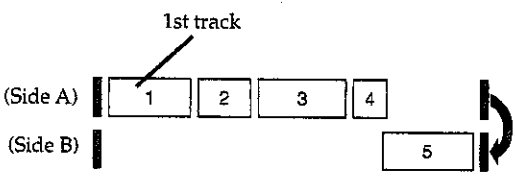

C

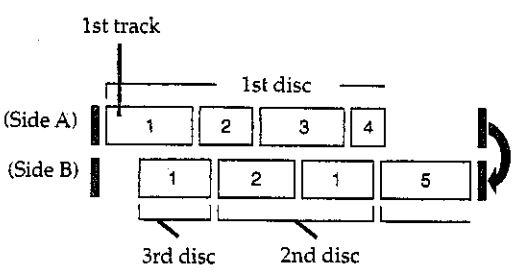

Recording from compact discs

For SC-EH500

DECK 2 only

There are 2 ways to record from compact discs, normal recording and one-touch editing.

Normal recording **A**

In normal recording, no blank space is left at the end of side A. But, this means a track will be cut off in the middle when the end of the side is reached. This method can also be used to record onto a tape from a desired point halfway through one side, or to record from programmed CDs.

One-touch editing [AI EDIT] **B**

The tape deck automatically reads the length of the loaded tape, and then calculates which tracks go on which side of the tape so that no track is cut in the middle when the tape reaches either end.

One-touch editing operation:

1. The cassette deck will fast-forward and rewind to measure its length.
2. The cassette deck will advance the tape beyond the leader tape, and then stop.
3. The CD player assigns tracks to tape side A and B, and displays the result. In addition to the above information, the remaining time of tape side A and B will be displayed.
4. Actual recording starts.

Notes

- Use a tape of under 99 minutes.
- You cannot edit-record tracks numbering higher than 24.

Recording onto left over space on tapes (LINK): **C**

After the edit-recording of loaded CD have finished, you can subsequently edit-record other CD(s) on the remaining blank portion of the tape.

This function is convenient when recording from 8 cm CDs successively.

For your reference:

It is better to use a tape slightly longer than the CD playing time when recording.

Recording from compact discs

For SC-EH500

Normal recording

- 1** Switch on the power.
- 2** Press **▲ OPEN** on deck 2, and then insert the tape with the exposed part of the tape facing downward.
Close the holder.
- 3** To record in Dolby B NR.
Press **DOLBY NR** and check "NR" is displayed.
- 4** Press **REV MODE** to select the reverse mode.
 - ➡: One side will record, and then the tape will stop automatically at the end of the tape.
 - ↔: Both sides will record (forward side → reverse side), and then the tape will stop automatically at the end of the tape.
 - ↔: Same as above (When you press ● **REC PAUSE**, "↔" will be automatically switched over to "↔").
- 5** Set the tape travel direction.
To change the tape travel direction, first press ◀ or ▶ on the cassette deck, then ■.
▶: Recording from the forward side
◀: Recording from the reverse side
- 6** Press **▲ OPEN/CLOSE** to load a CD.
Press **▲ OPEN/CLOSE** again to close the tray.
- 7** Press ● **REC PAUSE** to put the cassette deck into the recording standby mode.
REC PAUSE indicator lights.
The playback indicators ◀ or ▶ will start flashing.
- 8** Press ▶ on the CD player.
The recording will automatically start corresponding to the tape travel direction.

Approximately 4 seconds after the CD finishes playing, the cassette deck will automatically put recording on standby.

To stop recording:

- **To add a 4 second silent interval before stopping**
Press ■ on the CD player.
The cassette deck will go into the recording standby state.
- **To stop recording without a silent interval**
Press ■ on the cassette deck.
The CD player does not stop.

To record programmed tracks **A**

- ① Perform steps **1-6** above, and then press **CD/TAPE** on the remote control to select "CD".
- ② Press **PROGRAM** on the remote control.
- ③ Select the track number from the remote control with the numeric button(s).
- ④ Repeat step ③ until all desired tracks are programmed (max. 24 tracks).
- ⑤ Perform above steps **7** and **8**.

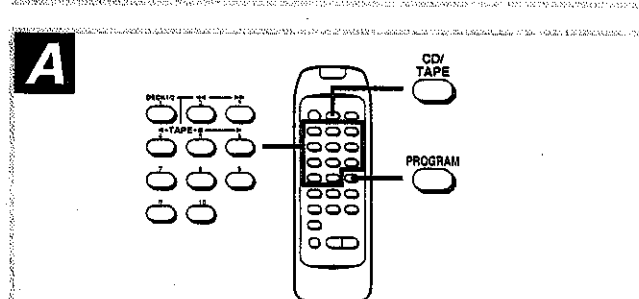
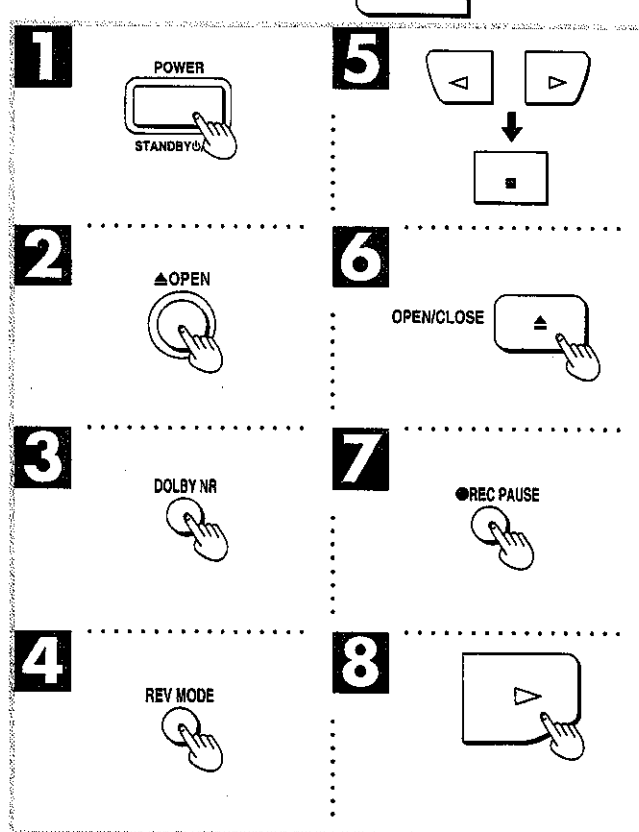
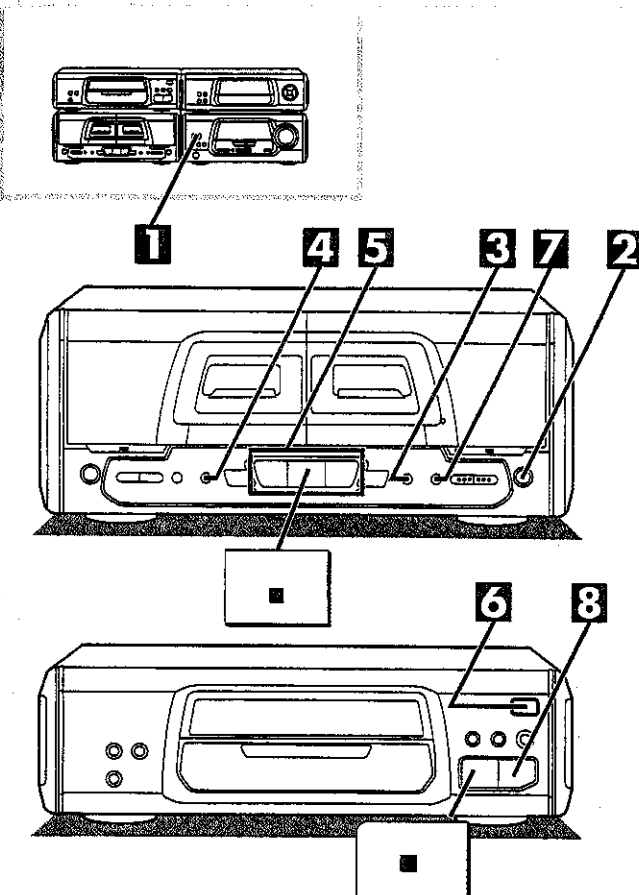

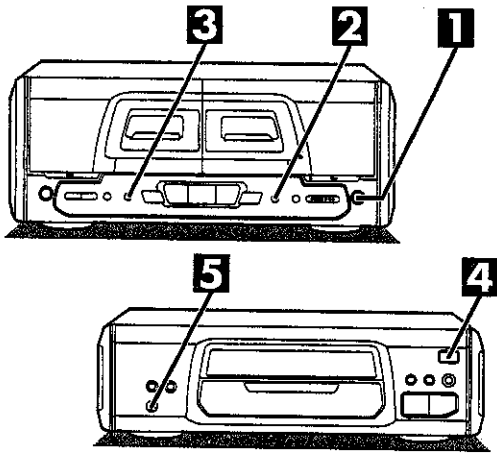
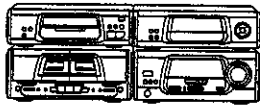

1 OPEN

2 DOLBY NR

3 REV MODE

4 OPEN/CLOSE

5 AI EDIT

A

Recording from compact discs

For SC-EH500

One-touch editing

- 1** Press **▲ OPEN** on deck 2, and then insert a tape.
Close the holder.
- 2** To record in Dolby B NR.
Press **DOLBY NR** and check "DQ NR" is displayed.
- 3** Press **REV MODE** to select the reverse mode.
 - : One side will record, and then the tape will stop automatically at the end of the tape.
 - : Both sides will record (forward side→reverse side), and then the tape will stop automatically at the end of the tape.
 - : Same as above (When you press AI EDIT, "C" will be automatically switched over to "AI").
- 4** Press **▲ OPEN/CLOSE** to load a CD.
Press **▲ OPEN/CLOSE** again to close the tray.
- 5** Press **AI EDIT**.
The deck will rewind the tape and recording will start. In the meantime, "AI EDIT" will scroll across the display from right to left. It will take a moment for recording to actually begin.

To stop one-touch editing:

Press **■** on the cassette deck.

The CD player also stops.

"EDIT OUT" will scroll across the display from right to left.

When tracks are allotted to side B:

After recording the allotted tracks on side A, the cassette deck will continue recording on side A and will make a blank portion on side A in order to measure the proper length of the tape.

To edit-record programmed tracks **A**

- ① Perform steps **1-4** above, and then press **CD/TAPE** to select "CD" and then press **PROGRAM** on the remote control.
- ② Select the track number from the remote control with the numeric buttons.
- ③ Repeat step ② until programming all tracks (max. 24 tracks).
- ④ Press **AI EDIT**. Recording will begin.

After edit-recording has finished:

The tape deck automatically puts recording on standby. In the meantime, if "LINK" is flashed on the display, there is enough space on the tape that you can continue recording from another CD (see page 43).

If you want to link the tracks, do not press **■** on the CD player.

Recording from compact discs

For SC-EH500

Recording onto left over space on tapes (LINK)

You can link up another CD when "LINK" flashes after editing a CD.

1 Press **▲** OPEN/CLOSE to replace the CD with another one.

Press **▲** OPEN/CLOSE again to close the tray.

2 Press **▷**.
Linking will start.

To continue linking tracks:

Repeat steps **1** and **2**.

As long as there is space on the tape to record, when the recording finishes, the cassette deck will put linking on standby.

To cancel the LINK function:

Press **■** on the CD player.

Linking programmed tracks **⏏**

- 1 Perform step **1** above, and then press PROGRAM on the remote control.
- 2 Select the track number from the remote control with the numeric button(s).
- 3 Repeat step **2** until all desired tracks are programmed (max. 24 tracks).
- 4 Press **▶**. Linking will begin.

Notes

- When the display shows "0:00", you cannot record from another CD. Press **■** on the CD player.
- If the time remaining on the tape is shorter than the length of a track to be recorded, you cannot record a track. Replace with a track shorter than the time remaining on the tape or press **■** on the CD player.

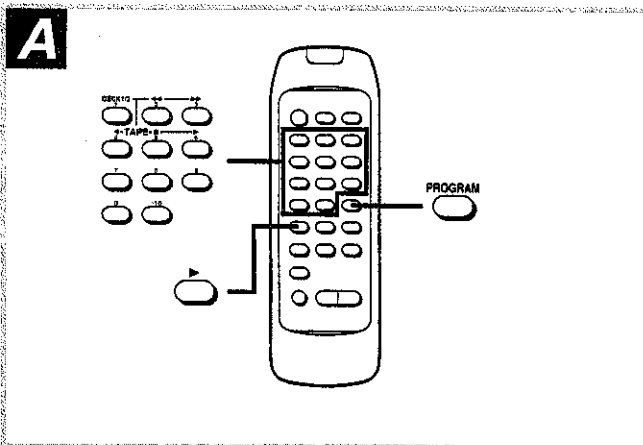
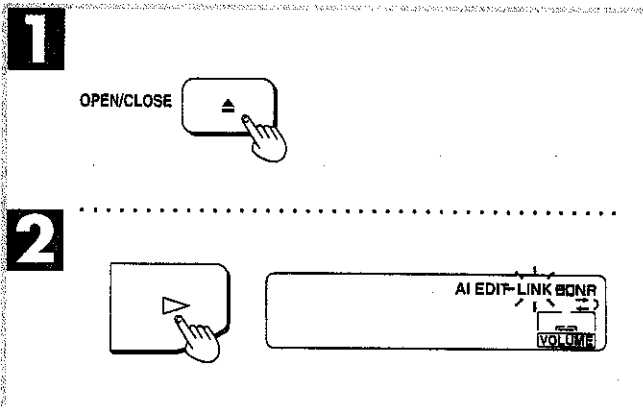
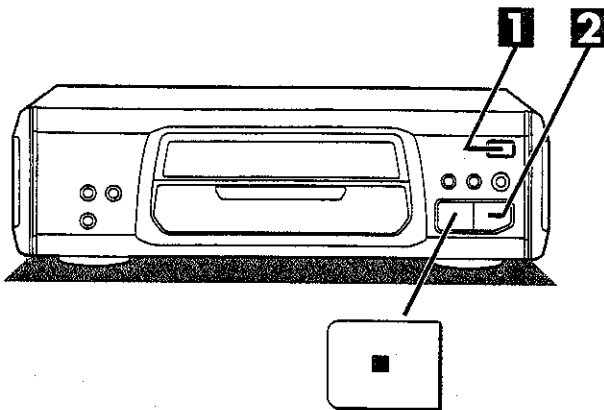
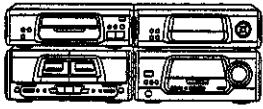

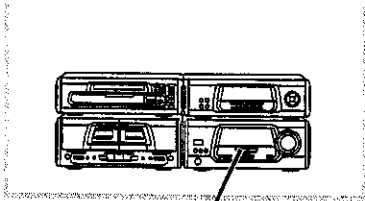

1

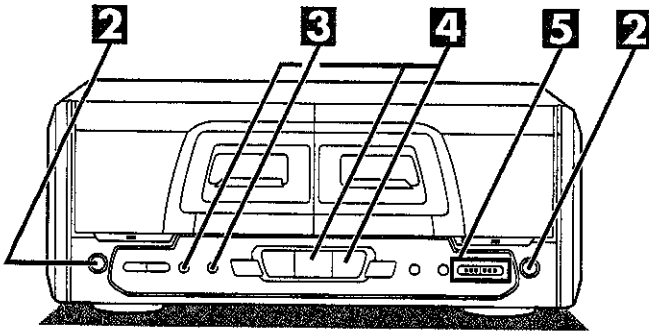

Tape-to-tape recording

Preparation

The leader tapes in both decks must be wound up beforehand. (See page 34.)

- 1** Press **INPUT SELECTOR** to select "TAPE".
- 2** Press **▲ OPEN** on the both decks and insert the tapes.
DECK 1: For playback
DECK 2: For recording
Close the holders.
- 3** Press **REV MODE** to select the reverse mode.
 - ↔: Single-sided recording
 - ↔↔: Two-sided recording (forward side→reverse side)
 - ↔↔↔: Same as above (When you press NOR or HIGH, "↔↔↔" will be automatically switched over to "↔↔").
- 4** Set the tape direction "**>**" of deck 1 and 2.
Press **DECK 1/2** and confirm both deck's tape directions are "**>**".
To change the tape direction, first press **>**, and then **■**.
To record on the reverse side, set deck 2 to "**<**".
- 5** Press **NOR** or **HIGH** of **TAPE EDIT** to start recording.

NOR: When you wish to monitor the sound while recording
HIGH: When you wish to record at high speed (about 2.0 times normal speed)

While recording, both deck 1 and 2 indicators light up. The tape direction indicator (< or >) shows deck 2 direction.
If either deck 1 or deck 2 stops, the other deck also stops.

To stop recording:

Press **■**.
Both decks will stop.

To enjoy another source while recording:

Start playing the other sound source.
You can change the volume level and tone quality without affecting the recording.

Notes

- During high speed recording, turn off TVs or any other image projecting equipment so as to prevent static from being recorded.
- Tone changes and special effects cannot be recorded.
- The recording level and the noise reduction effect of the original (playback) tape will be recorded on the new tape.

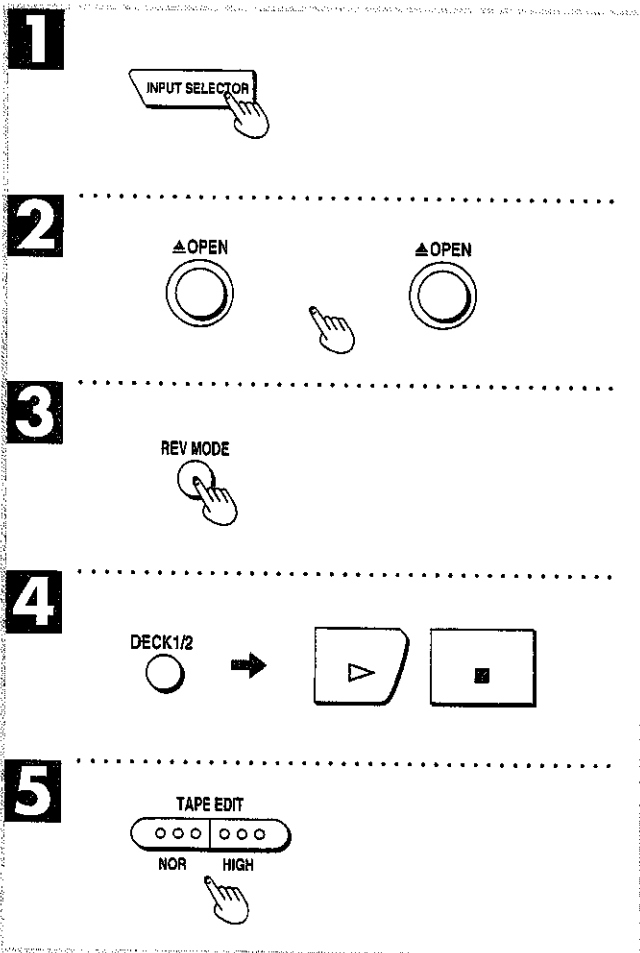

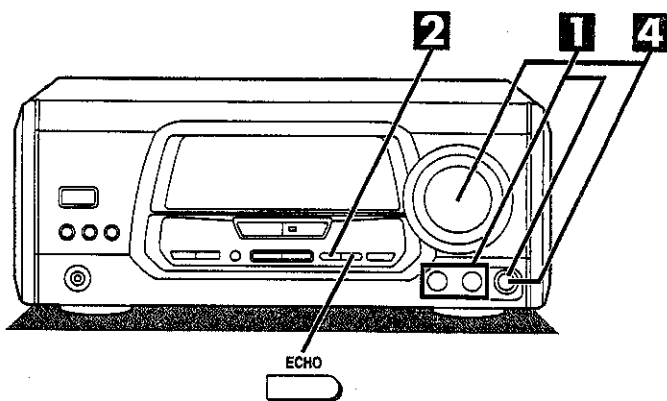
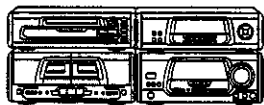

Singing along with KARAOKE

(For Australia and N.Z. only)

This unit lets you enjoy the KARAOKE fun with audio CDs and audio tapes.

1 First, lower volume with MIC volume control, then, connect the microphone to the MIC jack.
Plug type: 6.3 mm monaural

2 Press KARAOKE to select the voice mode.
Each time the button is pressed, the display will change in the following order:

V • MUTE → MONO L → MONO R
 ↑ ↓
 OFF

Voice mode selection:

○: Appropriate ●: For practice, etc.

Voice modes	Karaoke		Non-karaoke
	Sound multiplex	Stereo	
OFF	● (Background music+ Voice)	○	● (For singing along)
V • MUTE	—	—	○
MONO L	○ (Background music)	—	—
MONO R	● (Voice)	—	—

Note

A bar is indicated in the above table when the voice mode is least effective. It is better to avoid using the mode in such cases.

3 Start the source (CD, etc.).

4 Adjust volume with VOLUME and MIC volume control, and sing along.

To cancel the KARAOKE:

Press KARAOKE to select "OFF" mode.

You cannot use "KARAOKE" function with:

- a tone quality effect (HALL, HEAVY, CLEAR, MANUAL and ACOUSTIC IMAGE EQ effect)
- a radio source

To record your "KARAOKE" performance:

Start recording in deck 2, then start "KARAOKE" performance. To playback the tape recorded in "KARAOKE" mode, press KARAOKE so that the KARAOKE indicator goes out.

You cannot record in "KARAOKE" mode using:

- a tone quality effect (HALL, HEAVY, CLEAR, MANUAL and ACOUSTIC IMAGE EQ effect)
- a broadcast

When using the V. MUTE (Voice Mute) function

Always use software recorded in stereo. Voice mute may not function sufficiently or noise may interfere when using the following software.

- Monoaural software
- Software with few musical instruments, including classic music and poetry recitations
- Software with duets or strong choruses

Using the Echo Effect

Press ECHO.

Each time the button is pressed, the effect will change as follows.

ECHO 1 → ECHO 2 → ECHO 3 → ECHO 4
 ↑ ↓
 OFF

Echo levels from ECHO 1 to ECHO 4 can be selected.

1

2

3

4

A

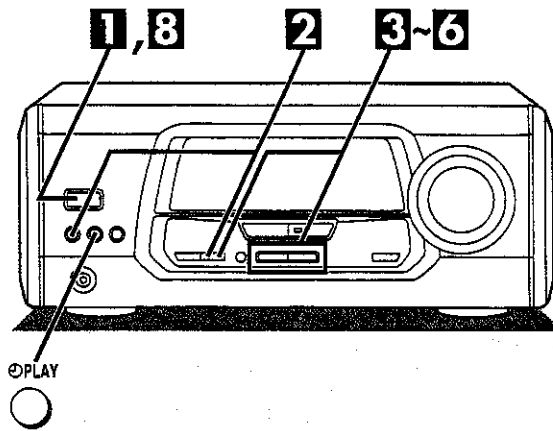
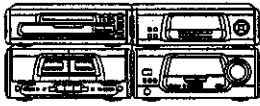

1

POWER
STANDBY/⏻

2

CLOCK/TIMER
⌚

SET

⓪PLAY

3

① TUNING

⓪PLAY

ON -6:00-

② SET

4

① TUNING

⓪PLAY

OFF -7:30-

② SET

5

① TUNING

⓪PLAY

② SET

6

TUNING

⓪PLAY

101.40

SET

7

8

POWER
STANDBY/⏻

⓪PLAY

10:37

Timer operations

Setting the play timer

Make sure that you have completed "Setting the time" on page 12. Select this timer when you want to use the timer as an alarm clock. You can wake up while listening to music (CD, tuner, tape) at a desired volume level and time. The figure shows how to set the play timer for; playing a CD at -40 dB from 6:00 to 7:30.

- 1 Switch on the power.**
- 2 Press CLOCK/TIMER twice to show "⊕ PLAY" on the display, and then press SET within 3 seconds.**
- 3 ("ON" time setting)**
 - ① Press TUNING (∨ or ∧) to show the time to start playing.
 - ② Press SET.
- 4 ("OFF" time setting)**
 - ① Press TUNING (∨ or ∧) to show the time to finish playing.
 - ② Press SET.
- 5 ① Press TUNING (∨ or ∧) to select the desired source.**

The display will change as follows.

CD ↔ TAPE ↔ TUNER

↕ ↕ ↕

 - ② Press SET.

When you select "TUNER", select a desired preset channel using TUNING (∨ or ∧), and then press SET.
- 6 Press TUNING (∨ or ∧) to adjust the volume level for the timer play, and press SET.**

The display will show ON time, OFF time, the source you select, and the volume level alternately, and then resumes the previous display.
- 7 Prepare for play.**

To play a CD: Load a CD.
To play a tape: Load a tape.
- 8 Press POWER to switch the power to standby mode.**

Please confirm "⊕ PLAY".
The timer play will start at the preset time with volume increasing gradually up to the volume level you preset.

To cancel the timer:

Press ⊕ PLAY to put out "⊕ PLAY".

The play timer function will be canceled, but the setting stays in the memory.

To confirm the play timer:

You can operate this even if the system is in the standby mode.

Press CLOCK/TIMER to show "⊕ PLAY".

The display will show ON time, OFF time, the source you select, and the volume level alternately.

To change the play timer setting:

Follow the procedure from the first step.

Using the timer at the same time setting continuously:

You can operate this even if the system is in the standby mode.

The play timer setting will stay in the memory.

1. Press ⊕ PLAY to show "⊕ PLAY".
2. Press POWER to switch the power to standby mode.

To enjoy a source after the timer setting is completed:

1. Start playing the desired source.

Even if you change the volume level or music source, the timer play will start with the preset condition.
2. Press POWER to standby mode after play.

Notes

- If the power is on, the timer will not function. The system must be in the standby mode.
- This system retains the ON/OFF time settings until you make a new setting. If you make a new ON time setting, you must make a new OFF time setting.
- You cannot make the ON time and OFF time the same setting.
- The play timer will function until you cancel the play timer mode. When the display shows "⊕ PLAY", the play timer will be activated.

For your reference:

When you insert cassettes in both deck 1 and 2, deck 1 has priority for timer play on tape.

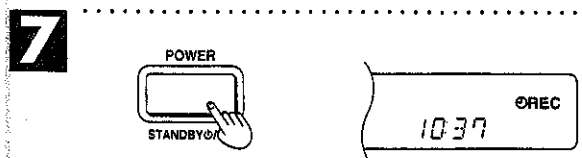
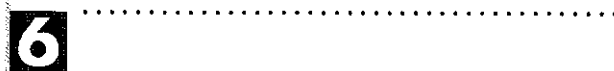
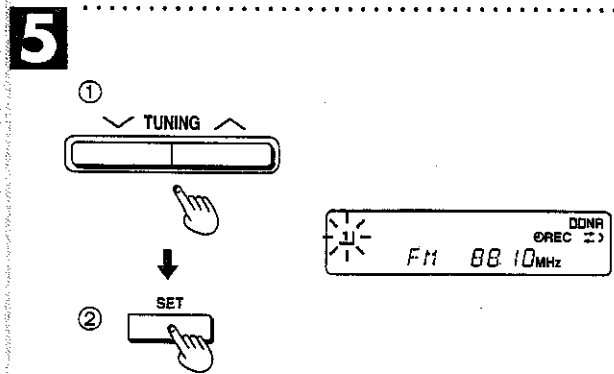
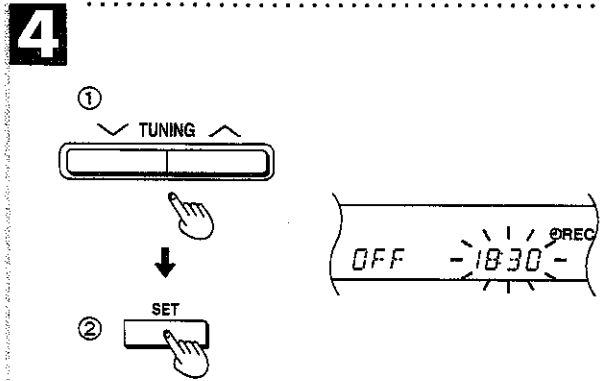
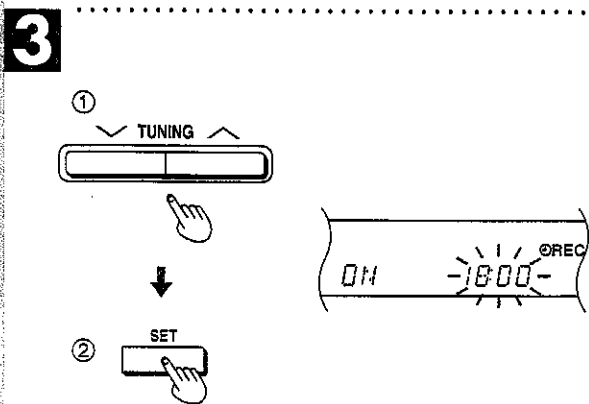
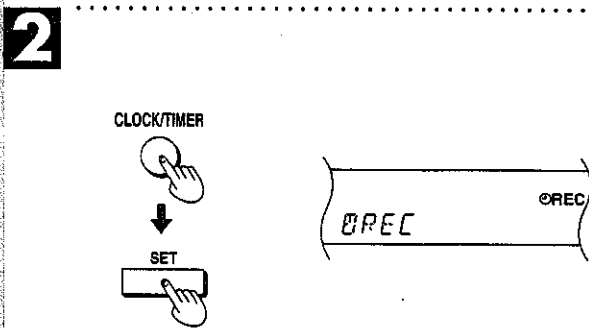
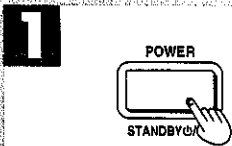
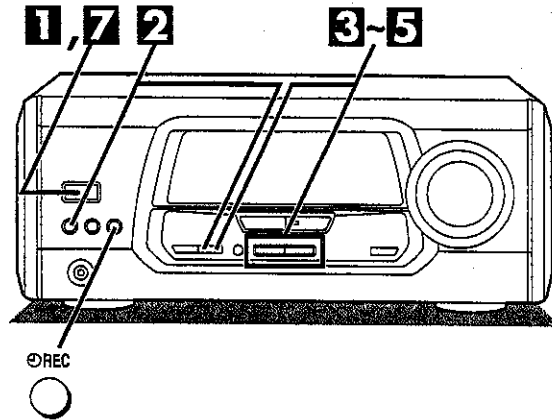
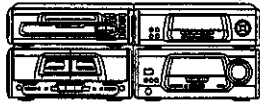

Using the timer

To use each timer mode in conjunction

To go to sleep listening to an FM broadcast and wake up the next morning listening to a CD

1. Make a play timer setting for a CD.
2. Tune in the desired band and station, and adjust the volume level.
3. Make a sleep timer setting.

To make a timer recording from a radio broadcast while sleeping, and wake up the next morning listening to a tape

1. Make a record timer setting.
2. Make a play timer setting for tape, and switch the power to standby mode. (Select "←→" of the reverse modes.)
Be sure to set the record timer to finish before the play timer begins.

To go to sleep listening to a CD, and then to make a timer recording from a radio broadcast

1. Make a record timer setting.
2. Play a CD, and adjust the volume level.
3. Make a sleep timer setting.
Be sure to set the system to switch to standby mode before the timer recording begins.

Timer sequence priority:

Sleep timer, record timer, play timer is the order of priority for the timer operations. Be sure not to overlap each timer setting.

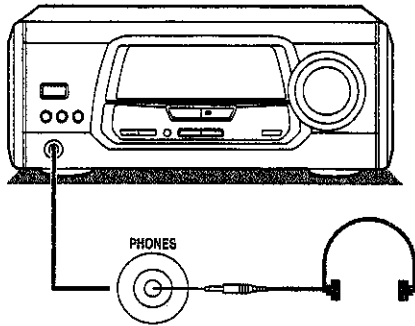
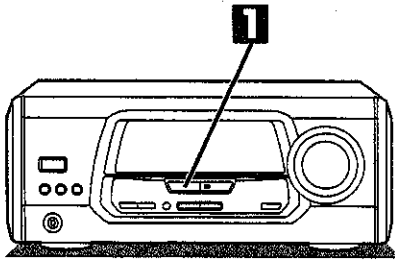
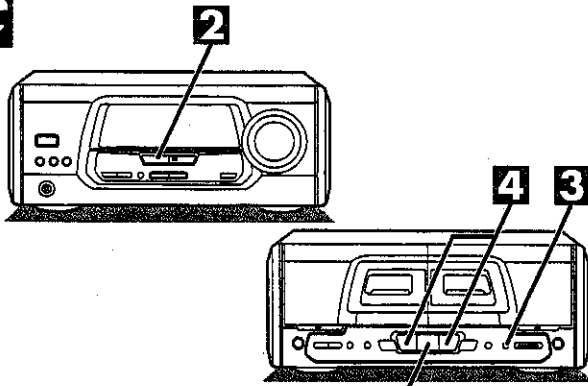
A**B****1****2****C****1****2****3**

● REC PAUSE

**4****5**

Using an external unit

To use headphones

- Before connecting, reduce the volume level.
- Avoid listening for prolonged periods of time to prevent hearing damage.
- Plug type: 3.5 mm stereo

Listening to an external source

1 Press INPUT SELECTOR to select the external source.

Each time you press this button, sound sources will be switched as follows.

SC-EH600

TUNER → CD → TAPE → EXT → VCR → VDP → PHONO

SC-EH500

TUNER → CD → TAPE → VCR (EXT) → VDP (AUX)

2 Operate the external unit which you have connected to the system.

Refer to your equipment's operating instructions.

SC-EH600 only

This stereo has a built-in DOLBY PRO LOGIC circuit, so you can enjoy the live sound of videos recorded in Dolby Surround (see page 31).

Recording from an external source

1 Follow steps 1-4 on page 35.

2 Press INPUT SELECTOR to select the external source.

3 Press ● REC PAUSE to put the cassette deck into the recording standby mode.

4 Press ◀ or ▶ to start recording.

5 Start playing the source to be recorded.

Refer to your equipment's operating instructions.

To stop recording:

Press ■ on the cassette deck.

To briefly interrupt recording:

Press ● REC PAUSE.

The cassette deck will go into the recording standby mode.

To resume recording:

Press ◀ or ▶ corresponding to the direction in which recording is taking place.

Recording on an external unit

First, select the source with INPUT SELECTOR.

Start recording on an external unit, and then start playing the source to be recorded.

Notes

(For Australia and N.Z. only)

• KARAOKE, MIC MIX, and ECHO can be recorded only if the KARAOKE is performed along with a CD.

• MIC MIX, from sources other than a CD can also be recorded if recording onto a VCR, but effects like KARAOKE or ECHO cannot

Remote control buttons and functions For SC-EH600



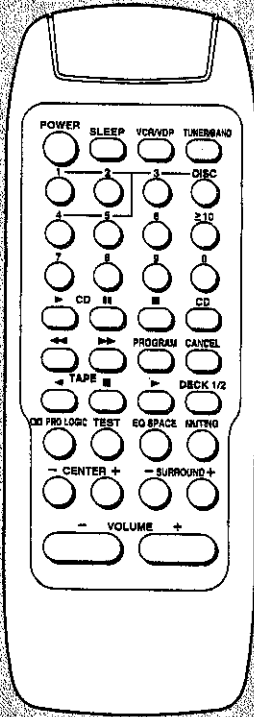







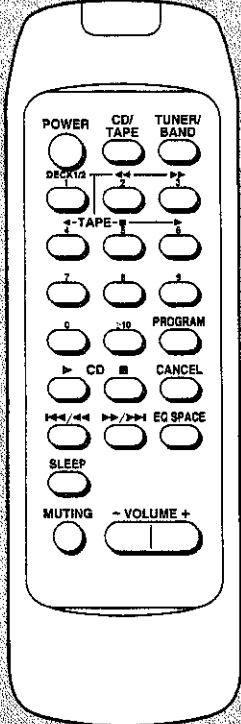





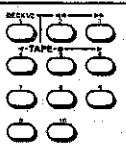

Reference pages are given as black circled numbers.



Button	Radio	CD	Tape	Other component
POWER 	Turns the system ON/OFF 12			
SLEEP 	For setting sleep timer 50			—
TUNER/BAND 	Band switching 13	—	—	—
DISC 	—	CD select mode 20, 21	—	—
	For station selection (In preset mode) 15	• CD selection (1-5) • Track selection 20, 21	—	—
	—	Playback (▶) 19	—	—
	—	Pause () 19	—	—
	—	Stop (■) 19	—	—
PROGRAM 	—	Engages program input 21	—	—
CANCEL 	—	Cancels program contents 21	—	—
	—	—	• Fast-forward/Rewind (While stopped) 25 • Skip to track beginning (During playback) 27	—
	—	—	• Playback 25 • Starts recording from recording standby mode. 25	—
DECK 1/2 	—	—	Switch between deck 1 and deck 2 25	—
	—	—	Stop (■) 25	—
VCR/VDP TUNER/BAND CD 	Input source selection			
EQ SPACE 	Switching between equalization curve and simulated listening environments 23 24			
PRO LOGIC 	Switching between DOLBY PRO LOGIC Surround modes 31			
TEST 	Outputting a test signal 42			
- CENTER + 	Adjusting the center speaker level 42			
- SURROUND + 	Adjusting the surround speaker level 42			
MUTING 	Mutes volume temporarily 40			
- VOLUME + 	For setting volume 15 19 25			

Remote control buttons and functions For SC-EH500

Reference pages are given as black circled numbers.

	Button	Radio CD Tape Other component			
		Radio	CD	Tape	Other component
	POWER 	Turns the system ON/OFF ⑫			
	CD/TAPE 	—	Selecting CD or Tape ⑳, ㉔		—
	TUNER/BAND 	Band switching ⑩	—	—	—
	DECK1/2 	—	—	Switch between deck 1 and deck 2 ㉕	—
		—	—	<ul style="list-style-type: none"> •Fast-forward / Rewind (While stopped) ㉖ •Skip to track beginning (During playback) ㉗ 	—
		—	—	<ul style="list-style-type: none"> •Playback ㉘ •Starts recording from recording standby mode. ㉙ 	—
		—	—	Stop (■) ㉚	—
		For station selection (In preset mode) ⑪	Track selection ㉛, ㉜	—	—
	PROGRAM 	—	Engages program input ㉞	—	—
	CANCEL 	—	Cancels program contents ㉟	—	—
		—	Playback (▶) ㉡	—	—
		—	Stop (■) ㉢	—	—
		—	Forward/Backward skip ㉣ Forward/Backward search ㉤	—	—
	EQ SPACE 	Switching between equalization curve and simulated listening environments ㉦ ㉧			
	SLEEP 	For setting sleep timer ㉨			
MUTING 	Mutes volume temporarily ㉩				
- VOLUME + 	For setting volume ⑬ ㉪ ㉫				

Suggestions for safety

Placement

Avoid placing the unit in areas of:

- direct sunlight
- high temperature
- high humidity
- excessive vibration
- uneven surfaces (Place the unit on a flat level surface.)

Such conditions might damage the cabinet and/or other component parts and thereby shorten the unit's service life.

To protect the unit against sound distortion and acoustical effects, please place the unit at least 15 cm away from wall surfaces etc.

Stacking

Never place heavy items on top of the unit or the AC power cord.

Voltage

- It is very dangerous to use an AC power source of high voltage such as for an air conditioner.
A fire might be caused by such a connection.
- A DC power source cannot be used.
Be sure to check the power source carefully, especially if on a ship or other place where DC is used.

Power cord protection

- Avoid cuts, scratches or poor connection of the AC power cord, as this may result in fire or electric shock.
Excessive bending, pulling or slicing of the cord should also be avoided.
- Do not pull on the cord when you are disconnecting the power, as this could cause an electric shock. Grasp the plug firmly when you disconnect the power supply.
- Never touch the plug with wet hands or a serious electric shock could result.

Foreign materials

- Ensure that no foreign objects, such as needles, coins, screwdrivers etc., accidentally fall into the unit.
Otherwise, a serious electric shock or malfunction could occur.
- Be extremely careful about spilling water or liquid on/into the unit, as a fire or electric shock could occur.
(Disconnect the power plug and contact your dealer immediately if this occurs.)
- Avoid spraying insecticides onto the unit as they contain flammable gases which can be ignited.
- Insecticides, alcohol, paint thinner and similar chemicals should never be used to clean the unit as they can cause flaking or cloudiness to the cabinet finish.

Service

- Never attempt to repair, disassemble or reconstruct the unit if there seems to be a problem.
A serious electric shock could result if you ignore this precautionary measure.
- If a problem occurs during operation (the sound is interrupted, indicators fail to light up, smoke is detected, etc.) contact your dealer or Authorized Service Center immediately.
- Disconnect the power supply if the unit will not be used for a long time. Otherwise the operation life could be shortened.

For SC-EH600

Before moving or shipping this CD changer:

Prepare the CD changer as described below to prevent damage to the mechanism.

1. Remove all CDs.
2. Select "CD" with INPUT SELECTOR on the tuner/amplifier.
3. Hold down stop button (■) on the changer for 5 seconds.
This will turn OFF the power and set the so-called "shipping mode".
4. Unplug the stereo.

Avoid strong vibrations or impact while moving the equipment. This shipping mode will be canceled automatically when you turn the power ON the next time.

A

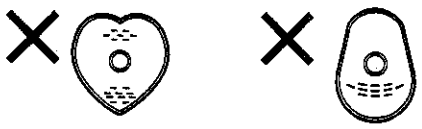

Concerning compact discs

With this changer or player, you can only play compact discs having this mark. However, do not use irregular shape CDs. CDs of this sort can damage the unit. **A**



B

How to return CDs to their case

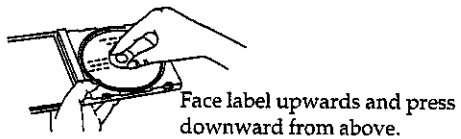

Handling precautions

B-D

- If you are taking the CD from a cold to a warm environment, moisture may form on the CD. Wipe this off with a soft, dry, lint-free cloth before using the CD.
- Do not write on the label side with a ball-point pen or other writing instrument.
- Do not use record cleaning sprays, benzine, thinner, static electricity prevention liquids or any other solvent.
- Do not attach labels or stickers to CDs. (Do not use CDs with exposed adhesive from tape or left over peeled off stickers.)
- Do not use scratch-proof protectors or covers other than those specified for use with this system.

C

How to hold CDs

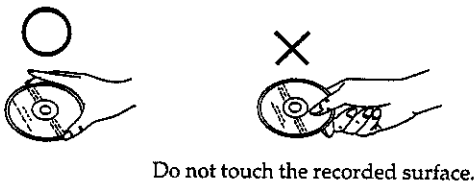

Storage precautions

Be sure to store discs in their cases to protect them from dust, scratches, and warping.

Do not place or store discs in the following places:

- Locations exposed to direct sunlight
- Humid or dusty locations
- Locations directly exposed to a heat vent or heating appliance
- In the glove compartment or on the rear deck of an automobile

D

How to clean CDs

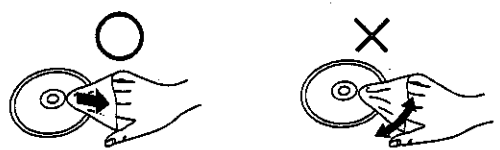

Concerning cassette tapes

Selection of cassette tapes

Tapes can get caught on the capstans. Use caution with the following types of tapes.

Cassette tapes exceeding 100 minutes

Tapes are made of a thin film material. Do not repeatedly advance and stop the tape, fast-forward it or rewind it.

Endless-tapes

For this unit, it is recommended to use tapes which are appropriate to the auto reverse mechanism.

Always read the instructions provided with your tapes.

E

How to take up tape slack



Tape slack

E

Tape slack may cause the tape to break. Use a pencil or similar object to take up the slack.

F

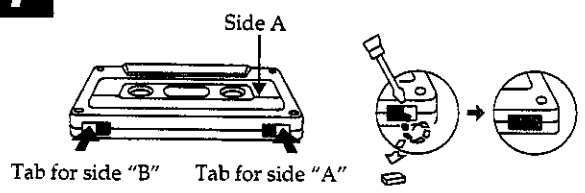

Erasure prevention

F

Use a screwdriver or similar object to break out the tab. To re-record on a protected cassette, cover the hole with cellophane tape.

Do not cover the discrimination hole on hi-position tapes.

To re-record Normal tape

Hi-position tape

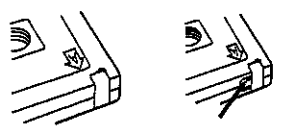

Storage precautions

You can damage tapes if you store them in the following places;

- In areas of high temperature (35°C or higher) or high humidity (80% or higher)
- In a strong magnetic field (near a speaker, on top of a TV, etc.) This can erase a recording.
- In areas exposed to direct sunlight

Technical specifications

SOUND PROCESSOR

■ EQ/SFP section

MANUAL GEQ

Center frequency	100 Hz, 315 Hz, 1 kHz, 3.15 kHz, 10 kHz
Level control	±3, 6, 9 dB

EQ SPACE mode

3 modes	HALL, CLEAR, HEAVY
Acoustic image equalizer	36 pattern

■ Pre-amplifier section (SH-EH600 only)

Input sensitivity/impedance

VCR	250 mV/15 kΩ
VDP	250 mV/15 kΩ

Output level

VCR RECOUT	250 mV/1.5 kΩ
------------	---------------

(For Australia and N.Z. only)

VIDEO OUTPUT

MONITOR OUT	1 Vp-p, 75Ω
VCR REC OUT	1 Vp-p, 75Ω

■ DOLBY PRO LOGIC section

(SH-EH600 only)

PRO LOGIC mode SURROUND, 3 STEREO

CENTER mode NORMAL, WIDE, PHANTOM

DELAY TIME 20 ms (Fixed)

■ Spectrum analyzer section

Display mode

NORMAL, PEAKHOLD, AURORA

■ General

Dimensions (W×H×D)	287×89×273.5 mm
Weight	1.1 kg

TUNER/AMPLIFIER

■ Amplifier section

(SA-EH600)

Power output (at HIGH terminal)

DIN 1 kHz, THD 1%, both channels driven	2×70 W (6Ω)
---	-------------

RMS 1 kHz, THD 10%, both channels driven	2×100 W (6Ω)
--	--------------

PRO LOGIC mode (at HIGH terminal)

DIN 1 kHz, THD 1%	
MAIN (both channels driven)	2×50 W (6Ω)
CENTER	50 W (8Ω)
SURROUND	50 W (4Ω+4Ω)

RMS 1 kHz, THD 10%	
MAIN (both channels driven)	2×70 W (6Ω)
CENTER	70 W (8Ω)
SURROUND	70 W (4Ω+4Ω)

Total harmonic distortion

Rated power at 1 kHz	1% (6Ω)
Half power at 1 kHz	0.09% (6Ω)

Load impedance

MAIN (HIGH/LOW)	total impedance 6Ω
CENTER	8Ω
SURROUND	4+8Ω

Input sensitivity/impedance

PHONO	2.5 mV/47 kΩ
EXTERNAL	250 mV/15 kΩ

Output level

EXTERNAL RECOUT	250 mV/1.5 kΩ
-----------------	---------------

S. WOOFER

Center frequency	70 Hz
LEVEL (VOL -20 dB)	MID +8 dB MAX +12 dB

(SA-EH500)

Power output

DIN 1 kHz, THD 1%, both channels driven	2×50 W (6Ω)
---	-------------

RMS 1 kHz, THD 10%, both channels driven	2×75 W (6Ω)
--	-------------

Total harmonic distortion

Rated power at 1 kHz	1% (6Ω)
Half power at 1 kHz	0.09% (6Ω)

Load impedance (HIGH/LOW)

Total impedance 6Ω

Input sensitivity/impedance

EXTERNAL, AUX	250 mV/15 kΩ
---------------	--------------

Output level

EXTERNAL RECOUT	250 mV/1.5 kΩ
-----------------	---------------

S. WOOFER

Center frequency	70 Hz
LEVEL (VOL -20 dB)	MID +8 dB MAX +12 dB

■ FM tuner section

Frequency range	87.50-108.00 MHz (0.05 MHz steps)
-----------------	--------------------------------------

Sensitivity	1.8 μV (IHF usable)
S/N 26 dB	1.5 μV

S/N

MONO	70 dB (75 dB, IHF)
------	--------------------

Antenna terminal(s)

	75Ω (unbalanced)
--	------------------

■ AM tuner section

Frequency range	522-1611 kHz (9 kHz steps) 530-1620 kHz (10 kHz steps)
-----------------	---

Sensitivity (S/N 20 dB)

	500 μV/m
--	----------

■ Timer section

Clock	Quartz-lock type
Function	Play timer (1 time), Rec timer (1 time), Sleep (120 min, 30 min intervals)

Setting	1 minute-23 hours 59 minutes (1 min intervals)
---------	---

■ General

Power supply	
(For United Kingdom, Australia and N.Z.)	AC 230-240 V 50 Hz
(For others)	AC 230 V 50 Hz

Power consumption (SA-EH600) 205 W

(SA-EH500) 120 W

Dimensions (W×H×D) 287×118.5×343.5 mm

Weight (SA-EH600) 5.0 kg

(SA-EH500) 4.4 kg

CD player

■ Audio

DA converter	1 bit DAC MASH
Pickup	
Wavelength	780 nm

■ General

Dimensions (W×H×D)	(SL-EH600) 287×89×336 mm (SL-EH500) 287×89×273 mm
Weight	(SL-EH600) 2.4 kg (SL-EH500) 1.6 kg

CASSETTE DECK

Deck system

Stereo cassette deck

Track system 4 track, 2 channel

Recording system AC bias

Bias frequency 100 kHz

Erasing system AC erase

Heads

Deck 1 (Playback head) Permalloy head

Deck 2 (Recording/Playback head) Permalloy head

(Erasing head) Double gap ferrite head

Motors

Deck 1, 2 Capstan drive DC servo motor

Tape speed 4.8 cm/s

Wow and flutter 0.16% (WRMS)

Fast forward and rewind times

Approx. 110 seconds with

C-60 cassette tape

Frequency response (Dolby NR off)

TYPE I (NORMAL) 20 Hz-16 kHz (DIN)

TYPE II (HIGH) 20 Hz-16 kHz (DIN)

TYPE IV (METAL) 20 Hz-16 kHz (DIN)

S/N (Signal level=max recording level, TYPE II

type tape)

NR off 56 dB (A weighted)

Dolby B NR on 66 dB (A weighted)

Input sensitivity and impedance

REC (IN) 400 mV/23 kΩ

Output voltage and impedance

PLAY (OUT) 280 mV/360Ω

■ General

Dimensions (W×H×D) 287×118.5×277 mm

Weight 2.0 kg

FRONT SPEAKER

Type 3 way, 3 speakers

Speaker(s)

Woofer: 17 cm cone type

Mid range: 12 cm cone type

Tweeter: 6 cm cone type

Impedance Total 6Ω

Input power Total 160 W (Music)

Total 80 W (DIN)

Output sound pressure level 84 dB/W (1.0 m)

Cross over frequency 200 Hz, 8 kHz

Frequency range 42 Hz-22 kHz (-16 dB)

46 Hz-20 kHz (-10 dB)

■ General

Dimensions (W×H×D) 254×420×278 mm

Weight 5.9 kg

CENTER SPEAKER (SB-PC600)

Type 1 way, 1 speaker

Speaker

Full range: 10 cm cone type

Impedance 8Ω

Input power 100 W (Music), 50 W (DIN)

Output sound pressure level 85 dB/W (1.0 m)

Frequency range 75 Hz-18 kHz (-16 dB)

■ General

Dimensions (W×H×D) 270×122×172 mm

Weight 1.6 kg

SURROUND SPEAKER (SB-PS600)

Type 1 way, 1 speaker, Dipole type

Speaker

Full range: 8 cm cone type

Impedance 4Ω

Input power 50 W (Music), 25 W (DIN)

Output sound pressure level 85 dB/W (1.0 m)

Frequency range 190 Hz-20 kHz (-16 dB)

■ General

Dimensions (W×H×D) 206×115×161 mm

Weight 1 kg

Notes:

- Specifications are subject to change without notice. Weight and dimensions are approximate.
- Total harmonic distortion is measured by the digital spectrum analyzer.

MASH is a trademark of NTT.

Troubleshooting guide

Before requesting service, make the below checks. If you can't fix the system as described below, or if something not here listed occurs, contact the place of purchase. To install antennas, make adjustments and the sort, contact the place of purchase.

Problem	Probable cause(s)	Suggested remedy	Page
---------	-------------------	------------------	------

Problems common to all systems

Humming is heard while playing.	A power cord or fluorescent lamp is located in the vicinity of cables.	Keep electric appliances away from the stereo. Try plugging the cord in the other way.	/
Only one speaker is emitting sound.	One of the wires of the speaker cord is disconnected.	Connect the speaker cord correctly.	6, 7
There is no sound when a source is being played.	The (+) and (-) wire of the speaker cords are shorted.	Switch the system to the standby mode, and reconnect the speaker cords so that they are not shorted. Then switch on the power.	/
"U70" appears on the display.	Flat cables are not connected steadily.	Connect the flat cable steadily. When the "U70" display is not cleared after the flat cable have been connected properly, the unit is damaged. Consult your dealer.	6, 7

While listening to FM broadcasts

There is a "rushing noise" during a stereo broadcast which is not audible during a monaural broadcast.	The transmitting station is a long distance away.	If you are using an indoor antenna, change to an outdoor antenna.	9
You hear excessive noise during a stereo broadcast, and occasionally the sound disappears.	The installation location and orientation of the antenna are unsuitable.		
The stereo indicator flickers and does not light completely.	The transmitting station is a long distance away. The power of the TV set or VCR is ON.		
The sound during a stereo broadcast is highly distorted.	There is a building or mountain nearby. [Distortion is caused by interference between the signal from the transmitting station (direct wave) and the signal reflected from the building or mountain (reflected wave).]	Use a high-grade outdoor antenna, and install it in a good location, height, and orientation for reception.	9

While listening to AM broadcasts

You hear an unusual beat sound.	You are using the system at the same time you are playing a TV set.	Switch off the TV set, or use the system further away from it.	/
You hear a low-frequency hum.	The antenna wire is too close to the flat cables/power cord.	Move the antenna away from the flat cables/power cord.	/
The correct frequency can not be received.	Frequency step is set to 10 kHz.	Hold down the TUNER/BAND button for about 3 seconds (change frequency step to 9 kHz).	/

When there is a television set nearby

The picture on the TV disappears or stripes appear on the screen.	The location and orientation of the antenna are incorrect.	If you are using an indoor antenna, change to an outdoor antenna.	9
	The TV antenna wire is too close to the system.	Separate the antenna wire of the TV set from the system.	/

Problem	Probable cause(s)	Suggested remedy	Page
---------	-------------------	------------------	------

While listening to tapes

Sound is low, intermittent, or poor quality, noisy, scratchy, or unsteady.	Heads are dirty.	Clean the heads.	59
	Dolby noise reduction is set in the wrong position.	Set it to match the Dolby NR recording mode.	25
The deck does not enter the recording mode.	The erase-prevention tabs are removed from the cassette.	Attach tape to cover the space left by removal of the erase-prevention tabs.	56

While listening to compact discs

The display will not show the correct indication. Disc play does not start when you press the play button.	The disc is loaded upside down.	Reload the disc.	18, 22
	The disc is dirty.	Wipe the disc with a soft cloth.	56
	The disc is scratched.	Replace the disc with a new one.	
	The disc is badly warped.		
	The disc is nonstandard.	Replace the disc with a different one.	
	There is condensation inside the CD changer or the CD player.	Wait for 60 minutes before using the CD changer or the CD player.	

During one-touch editing

"NO TAPE" appears on the display.	No tape is loaded into deck 2.	Load a tape.	25
"CHANGE TAPE" appears on the display.	The protector tab on the tape is broken.	Cover the tab's hole with adhesive tape or use another tape.	56
SC-EH600 only "ERROR" appears on the display.	You tried to record tracks from a program containing more than one disc.	You cannot record programs if containing tracks from more than one disc. If wanting to do so, set the tape deck to normal recording.	

While using the remote control

The system cannot be operated with the remote control.	The batteries are installed in the reverse polarity.	Reinsert the batteries in the correct polarity.	5
	The batteries are worn.	Replace the batteries with new batteries.	5

The servicer will require all components to service your system. Therefore, should service ever be necessary, be sure to bring the entire system.

Maintenance

■ Maintenance of external surfaces

To clean this unit, use a soft, dry cloth.

If the surfaces are extremely dirty, use a soft cloth dipped in a soap-and-water solution or a weak detergent solution.

Wring the cloth well before wiping the unit.

Wipe once again with a soft, dry cloth.

Never use alcohol, paint thinner, benzine, or chemically treated cloths to clean this unit. Such chemicals may damage the finish of your system.

■ Tape head care

To assure sound quality for recording and playback, be sure to clean the heads with a cleaning tape (sold separately) after approximately every 10 hours of use.

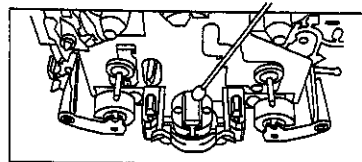

Free Manuals Download Website

<http://myh66.com>

<http://usermanuals.us>

<http://www.somanuals.com>

<http://www.4manuals.cc>

<http://www.manual-lib.com>

<http://www.404manual.com>

<http://www.luxmanual.com>

<http://aubethermostatmanual.com>

Golf course search by state

<http://golfingnear.com>

Email search by domain

<http://emailbydomain.com>

Auto manuals search

<http://auto.somanuals.com>

TV manuals search

<http://tv.somanuals.com>