

Technics®

Hi-Fi Component System

Operating Instructions

SC-S2350

SC-S245

This manual explains the audio components of this system.
The model number is SC-S2350 for the U.S.A. and SC-S245 for Canada.

Model No.

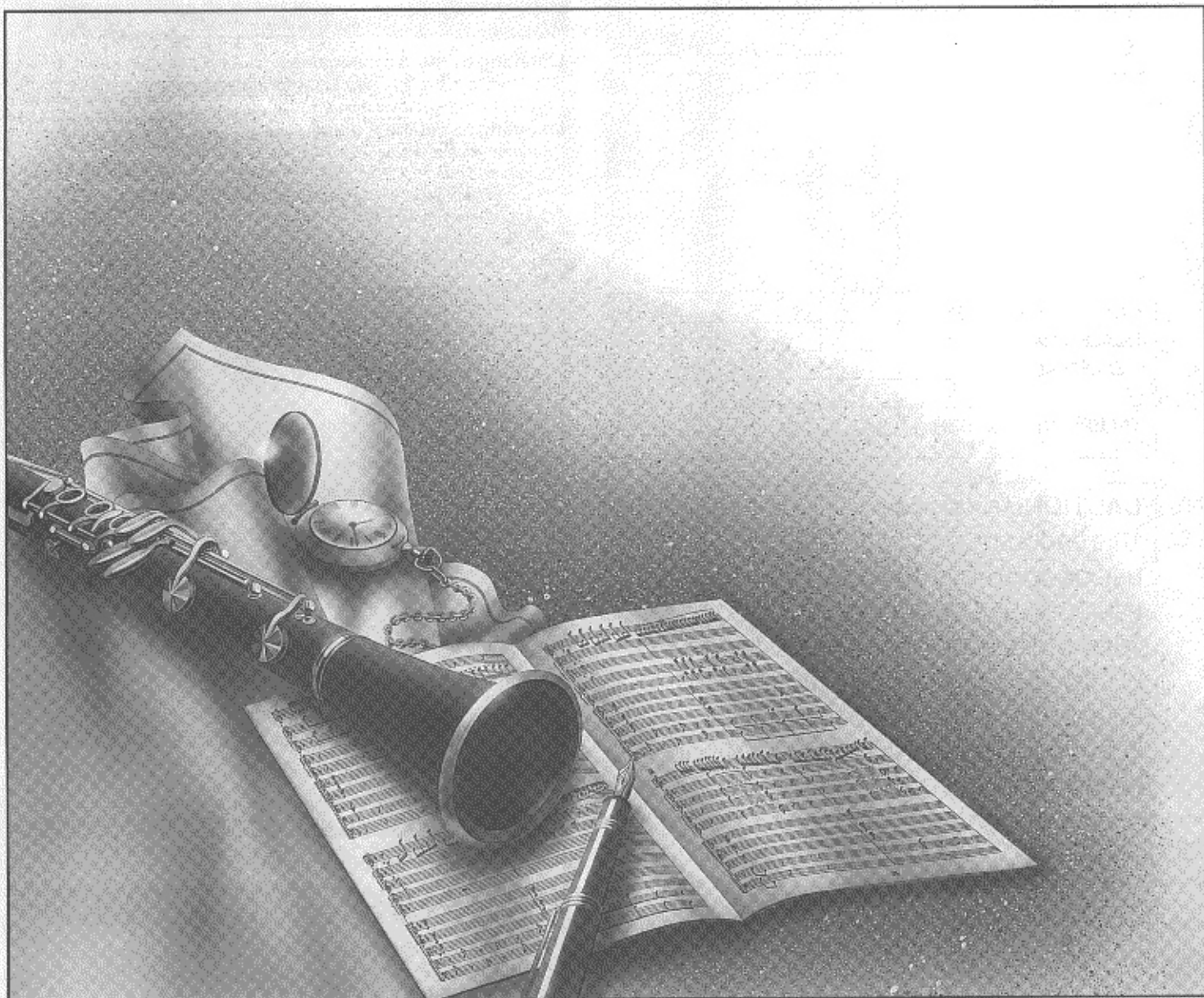

COMPACT
disc
DIGITAL AUDIO

Before connecting, operating or adjusting these components, please read these instructions completely.
Please keep this manual for future reference.

P PC

RQT5333-P

Dear customer

Thank you for purchasing this product.
For optimum performance and safety, please read these instructions carefully.

The model number and serial number of this product can be found on either the back or the bottom of the unit. Please note them in the space provided below and keep for future reference.

MODEL NUMBER	SERIAL NUMBER
Receiver : SA-G90	_____
Cassette deck : RS-TR180	_____
CD changer : SL-MC59	_____

User memo:

DATE OF PURCHASE _____
 DEALER NAME _____
 DEALER ADDRESS _____

 TELEPHONE NUMBER _____

CAUTION! (For SL-MC59)

THIS PRODUCT UTILIZES A LASER.
USE OF CONTROLS OR ADJUSTMENTS OR PERFORMANCE OF PROCEDURES OTHER THAN THOSE SPECIFIED HEREIN MAY RESULT IN HAZARDOUS RADIATION EXPOSURE.
DO NOT OPEN COVERS AND DO NOT REPAIR YOURSELF. REFER SERVICING TO QUALIFIED PERSONNEL.

Before use

Supplied accessories3
 PRECAUTIONS4
 To enjoy surround sound5
 Placement6
 Connections7
 Speaker connections11
 Concerning the remote control13
 Concerning the liner notes organizer13
 Setting/Removing discs14
 Concerning CDs15
 Concerning cassette tapes15
 Front panel controls16

Listening

Listening to radio broadcasts18
 To listen to the radio without presetting stations18
 Preset tuning20
 Listening to compact discs22
 Sequential play22
 Single disc play23
 Direct access play24
 Disc grouping play25
 Program play28
 Direct programming29
 Search function29
 Skip function30
 Listening to cassette tapes31
 Series playback33
 To fast-forward or rewind the tape34
 Tape counter34
 Other functions35
 To adjust the tone quality35
 To adjust the sound balance35
 To mute the sound level35
 To enjoy external sources35
 To listen through headphones35
 The TAPE (MONITOR) indicator36
 Dynamic range compression36
 Using a subwoofer36

Recording

Making a recording37

Sound modes

Digital Signal Processor (DSP)40

Remote control operation

Using the remote control44

Reference

Reference for speakers51
 About the HELP function53
 Listening caution53
 Maintenance53
 Specifications54
 Product service55
 Troubleshooting guide56
 Disc Index59
 Servicenter List (US)Back cover

Supplied accessories

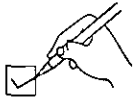

Please check and identify the supplied accessories

- AC power supply cords
(long type) (RJA0065-A) 1 pc.
(short type) (RJA0066-A) 2 pcs.

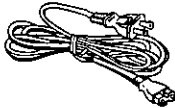

- Stereo connection cables
(RJL2P004B08) 3 pcs.



- FM indoor antenna
(RSA0006) 1 pc.



- AM loop antenna set (RSA0022)
AM loop antenna 1 pc.
AM loop antenna holder 1 pc.
Screw 1 pc.

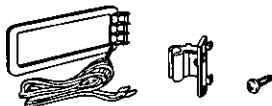

- Remote control
(EUR647132) 1 pc.



- Batteries 2 pcs.

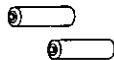

- Liner notes organizer
(RFA0622-K1) 1 pc.

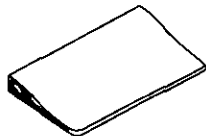

- Numbered stickers sheet 1 pc.



Use numbers indicated in parentheses when asking for replacement parts.

(Only for U.S.A.)

To order accessories contact 1-800-332-5368 or web site
(<http://www.panasonic.com>).

THE FOLLOWING APPLIES ONLY IN THE U.S.A.

CAUTION:

This equipment has been tested and found to comply with the limits for a Class B digital device, pursuant to Part 15 of the FCC Rules.

These limits are designed to provide reasonable protection against harmful interference in a residential installation. This equipment generates, uses and can radiate radio frequency energy and, if not installed and used in accordance with the instructions, may cause harmful interference to radio communications. However, there is no guarantee that interference will not occur in a particular installation. If this equipment does cause harmful interference to radio or television reception, which can be determined by turning the equipment off and on, the user is encouraged to try to correct the interference by one of the following measures:

- Reorient or relocate the receiving antenna.
- Increase the separation between the equipment and receiver.
- Connect the equipment into an outlet on a circuit different from that to which the receiver is connected.
- Consult the dealer or an experienced radio/TV technician for help.

Any unauthorized changes or modifications to this equipment would void the user's authority to operate this device.

This device complies with Part 15 of the FCC Rules. Operation is subject to the following two conditions: (1) This device may not cause harmful interference, and (2) this device must accept any interference received, including interference that may cause undesired operation.

WARNING:

TO REDUCE THE RISK OF FIRE, ELECTRIC SHOCK OR PRODUCT DAMAGE, DO NOT EXPOSE THIS APPLIANCE TO RAIN, SPLASHING, DRIPPING OR MOISTURE.

CAUTION:

TO PREVENT ELECTRIC SHOCK MATCH WIDE BLADE OF PLUG TO WIDE SLOT, FULLY INSERT.



CAUTION

**RISK OF ELECTRIC SHOCK
DO NOT OPEN**



CAUTION: TO REDUCE THE RISK OF ELECTRIC SHOCK, DO NOT REMOVE SCREWS. NO USER-SERVICEABLE PARTS INSIDE. REFER SERVICING TO QUALIFIED SERVICE PERSONNEL.



The lightning flash with arrowhead symbol, within an equilateral triangle, is intended to alert the user to the presence of uninsulated "dangerous voltage" within the product's enclosure that may be of sufficient magnitude to constitute a risk of electric shock to persons.



The exclamation point within an equilateral triangle is intended to alert the user to the presence of important operating and maintenance (servicing) instructions in the literature accompanying the appliance.

Before use

PRECAUTIONS

Before using this unit please read these operating instructions carefully. Take special care to follow the warnings indicated on the unit itself as well as the safety suggestions listed below. Afterwards keep them handy for future reference.

Before use

Safety

1. **Power Source** – The unit should be connected to power supply only of the type described in the operating instructions or as marked on the unit.
2. **Polarization** – If the unit is equipped with a polarized AC power plug (a plug having one blade wider than the other), that plug will fit into the AC outlet only one way. This is a safety feature. If you are unable to insert the plug fully into the outlet, try reversing the plug. If the plug should still fail to fit, contact your electrician to replace your obsolete outlet. Do not defeat the safety purpose of the polarized plug.
3. **Power Cord Protection** – AC power supply cords should be routed so that they are not likely to be walked on or pinched by items placed upon or against them. Never take hold of the plug or cord if your hand is wet, and always grasp the plug body when connecting or disconnecting it.
4. **Nonuse Periods** – When the unit is not used, turn the power off. When left unused for a long period of time, the unit should be unplugged from the household AC outlet.

Installation

Environment

1. **Outdoor Antenna Grounding** – If an outside antenna is connected to the receiver, be sure the antenna system is grounded so as to provide some protection against voltage surges and built-up static charges. Section 810 of the National Electrical Code, ANSI/NFPA No. 70-1990, provides information with respect to proper grounding of the mast and supporting structure, grounding of the lead-in wire to an antenna discharge unit, size of grounding conductors, location of antenna-discharge unit, connection to grounding electrodes, and requirements for the grounding electrode. See figure below.

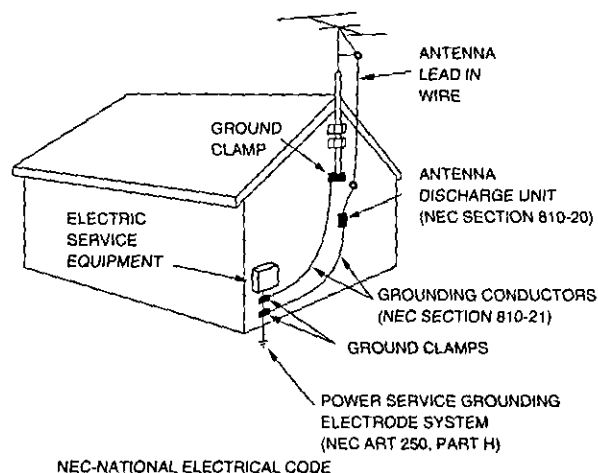

2. **Water and Moisture** – Do not use this unit near water-for example, near a bathtub, washbowl, swimming pool, or the like. Damp basements should also be avoided.
3. **Heat** – The unit should be situated away from heat sources such as radiators and the like. It also should not be placed in temperatures less than 5°C (41°F) or greater than 35°C (95°F).

4. **Condensation** – Moisture may form on the lens in the following conditions...

- immediately after a heater has been turned on,
- in a steamy or very humid room.
- when the unit is suddenly moved from a cold environment to a warm one.

If moisture forms inside this unit, it may not operate properly.

To correct this problem, turn on the power and wait about one hour for the moisture to evaporate.

Placement

1. **Ventilation** – The unit should be situated so that its location or position does not interfere with its proper ventilation. Allow 10 cm (4") clearance from the rear of the unit.
2. **Foreign Material** – Care should be taken so that objects do not fall into and liquids are not spilled into the unit. Do not subject this unit to excessive smoke, dust, mechanical vibration, or shock.
3. **Magnetism** – The unit should be situated away from equipment or devices that generate strong magnetic fields.
4. **Stacking** – Do not place heavy objects, other than system components, on top of the unit.
5. **Surface** – Place the unit on a flat, level surface.
6. **Carts and Stands** – The unit should be used only with a cart or stand that is recommended by the manufacturer. The unit and cart combination should be moved with care. Quick stops, excessive force, and uneven surfaces may cause the unit and cart combination to overturn.



7. **Wall or Ceiling Mounting** – The unit should not be mounted to a wall or ceiling, unless specified in this operating instructions.

Maintenance

(See page 53 for details.)

Clean the cabinet, panel and controls with a soft cloth lightly moistened with mild detergent solution.

Do not use any type of abrasive pad, scouring powder or solvent such as alcohol or benzine.

Service

1. **Damage Requiring Service** – The unit should be serviced by qualified service personnel when:
 - (a) The AC power supply cord or the plug has been damaged; or
 - (b) Objects have fallen or liquid has been spilled into the unit; or
 - (c) The unit has been exposed to rain; or
 - (d) The unit does not appear to operate normally or exhibits a marked change in performance; or
 - (e) The unit has been dropped, or the enclosure damaged.

2. **Servicing** – The user should not attempt to service the unit beyond that described in the operating instructions. All other servicing should be referred to authorized service personnel.

For the address of an authorized servicenter:

In the U.S.A. 1-800-211-7262 or web site

(<http://www.panasonic.com>)

In Canada 905-624-5505 or web site

(www.panasonic.ca)

To enjoy surround sound

Do the connections, settings, and adjustments in the order shown to enjoy surround sound with this unit's DSP features. Be sure to make the correct speaker settings.

Connect the equipment

(⇒ Page 7–10)



Position and connect the speakers

(⇒ Page 6, 11, 12)

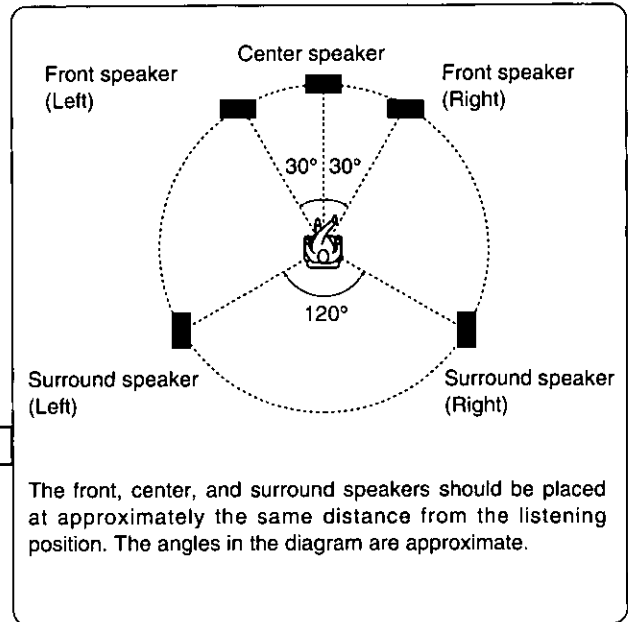

Before use

Set the distance of the speakers

(⇒ Page 51, 52)

Front, Center, and Surround speaker In DISTANCE

Enter the distance of each speaker from the listening position.



Adjust the level for the speakers

(⇒ Page 41, 43)

While sitting in the usual listening position, use the test signal to adjust the volume of the speakers to the same apparent level.



Sit back and enjoy the experience

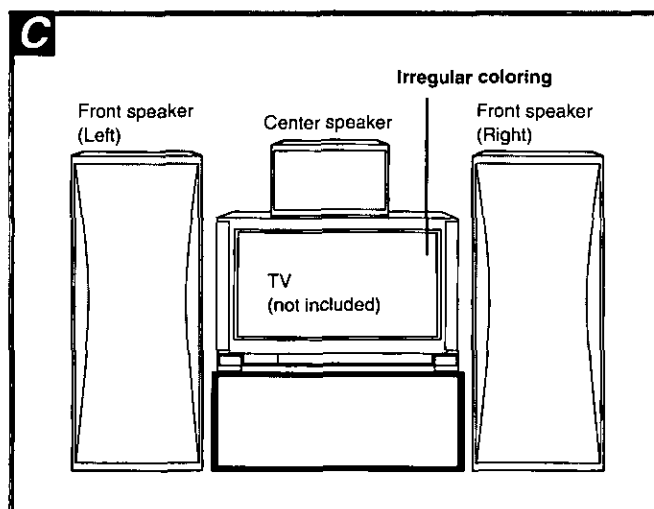
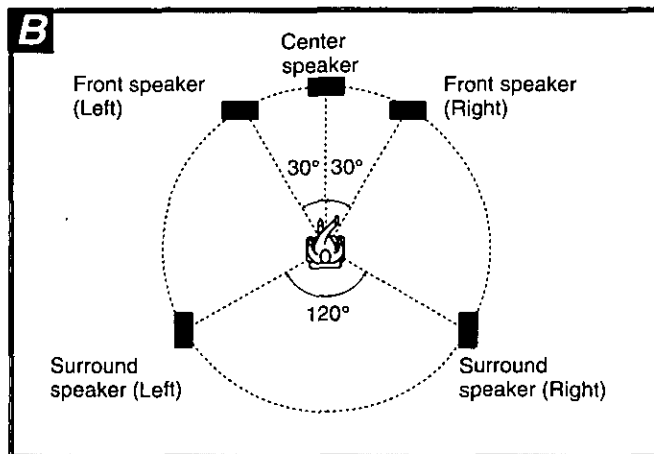
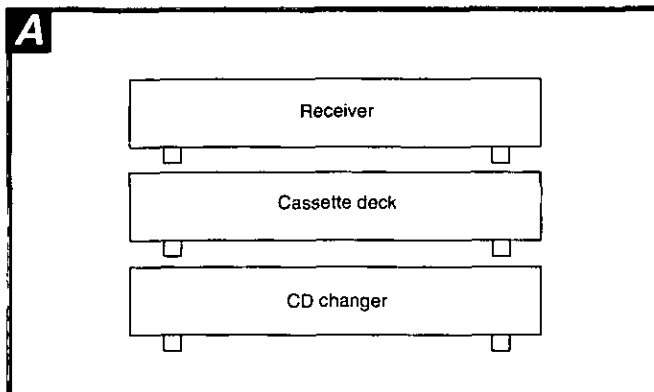

Placement

Placement of each unit **A**

Stack the units as shown in the illustration.

Placement of speakers **B**

The illustration shows where to place the speakers so as to best enjoy sound with the DSP modes.

Front speakers

Place on the left and right of the TV at seated ear height so that there is good coherency between the picture and sound.

Center speaker

Place underneath or above the center of the TV. Aim the speaker at the seating area.

Surround speakers

Place on the side of or slightly behind the listener, about one meter higher than ear level.

The sound reproduced by a speaker is easily influenced by such factors as room acoustics and the system's location in the room. Before finally deciding where the speakers are to be placed, please read the following information carefully.

- The bass sound will be increased if the speakers are placed on the floor or close to a wall due to reverberation. It is therefore possible to adjust the bass sound to some extent by adjusting the speaker's distance from the wall and/or floor.
- Undesirable resonance or reverberation will occur if the speakers face a hard wall or window. Curtains or similar materials can be used to prevent this.
- Keep the speakers away from sources of heat, high humidity and direct sunlight.

Note

- Keep your speakers at least 10 mm (13/32") away from the system for proper ventilation.
- The surround speakers do not have magnetic shielding. Do not place televisions, personal computers or other devices easily influenced by magnetism.

If irregular coloring occurs on your television **C**

The front and center speakers are designed to be used close to a television, but the picture may be affected with some televisions and set-up combinations.

If this occurs, turn the television off for about 30 minutes.

The television's demagnetizing function should correct the problem. If it persists, move the speakers further away from the television.

Cautions on moving the CD changer

Before moving the changer to another location, be sure to remove all discs from the slots and turn off the changer.

Failure to do so will expose the compact discs and the changer to the risk of severe damage.

CAUTION

The changer mechanism automatically locks when power is turned off, to protect it against damage in transport. Therefore, always press [POWER] and make sure "OFF" appears on the display before you unplug the changer.

Other cautions

Outside light or noise may sometimes cause the changer to detect a disc when there isn't one. However, the changer always correctly detects the disc when in the play mode no matter what.

Do not leave the front panel open. Dust or other matter getting into the changer may lead to damage or malfunctions.

Connecting system components

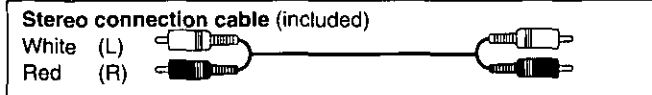
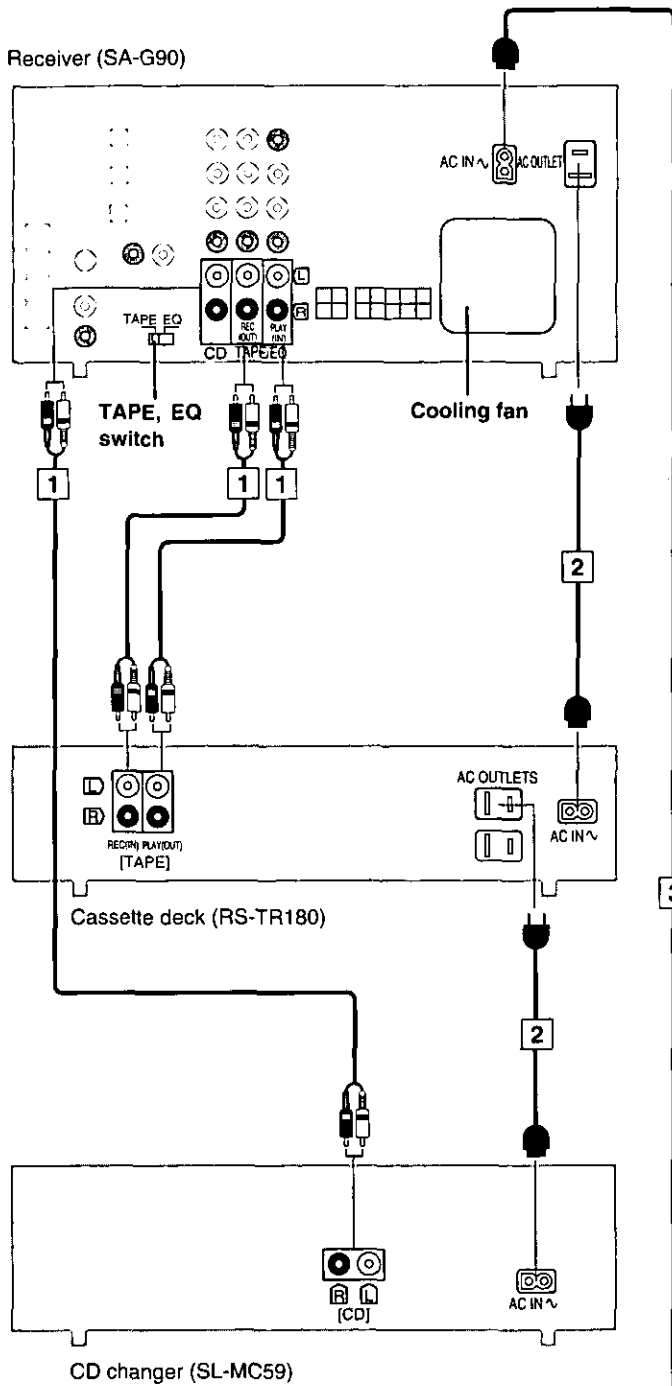

Make connections to each component with the included cords and cables.

- 1 Connect the stereo connection cables (3 pcs.).
- 2 Connect the AC power supply cords (short type) (2 pcs.).
- 3 Connect the AC power supply cord (long type) (1 pc.).

AC outlets of each unit
Do not connect video equipment (such as a TV, etc.) to these outlets. (These outlets are intended for audio equipment.)
Do not exceed the indicated power ratings when connecting to these outlets.

“SWITCHED” outlet
Power is controlled by the power switch.
“UNSWITCHED” outlet
Power is always available, regardless of power switch.

TAPE, EQ switch
Make sure this is switched to TAPE.
Concerning the cooling fan
The cooling fan operates only at high output power levels.

Note
The included AC power supply cord is for use with this unit only. Do not use it with other equipment.

Connect this cord after all other cables and cords are connected.

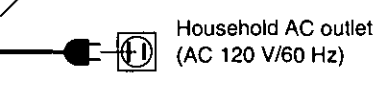

Conserving power
The receiver consumes 1 W even when it is turned off with [POWER, ⏻].
The cassette deck consumes 2.8 W even when it is turned off with [POWER, STANDBY ⏻ /ON].
The CD changer consumes 3.6 W even when it is turned off with [POWER, STANDBY ⏻ /ON].
To save power when the unit is not to be used for a long time, unplug it from the household AC outlet.
If the receiver is left unplugged for longer than a few weeks, all settings will revert to the factory settings. Do the settings again if this occurs.

Before use

Connections

Stereo connection cable (not included)

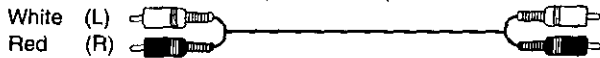

Optical fiber cable (not included)

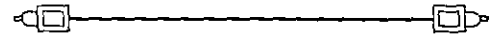

For details, refer to the instruction manual of the unit to be connected.

Connecting audio and video equipment

Before use

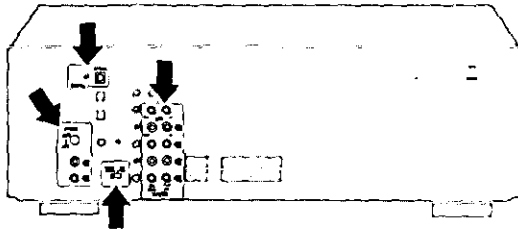

Receiver

CD player (or CD changer)
with digital output
(not included)

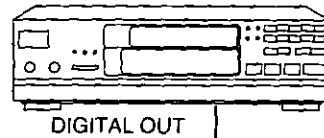

VCR (not included)

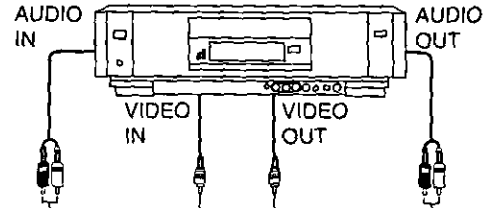

Connection for optical fiber cable

Dust-protection cap

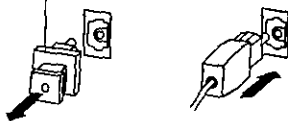

- Do not bend the optical fiber cable.
- If the digital optical connector is not going to be used, be sure to attach the dust-protection cap to prevent exposure to dust.

Note

Dolby Digital RF (radio frequency) signals cannot be decoded with this unit.

Only for turntable
with ground terminal

Turntable (not included)

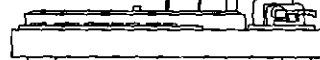

TAPE, EQ
switch

Connecting a graphic equalizer

Note

With this setup, set the TAPE, EQ switch to EQ and turn TAPE MONITOR on (➔ page 36). Distortion can occur if TAPE, EQ is switched to TAPE.

Graphic equalizer
(SH-GE50)
(not included)

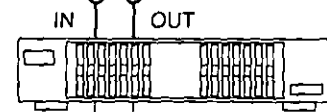

REC
(OUT) PLAY
(IN)

REC
(IN) PLAY
(OUT)

Cassette deck
(RS-TR180)

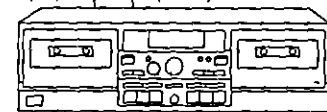

Video connection cable (not included)

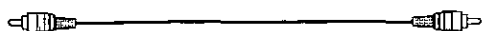

Connecting a TV and a DVD player

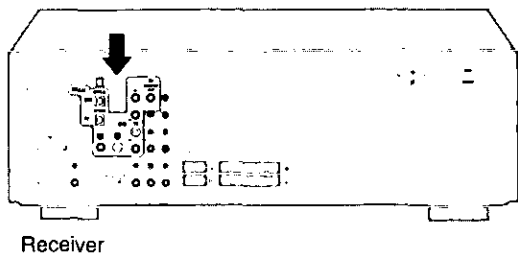

Receiver

DVD player (DVD-RV30) (not included)

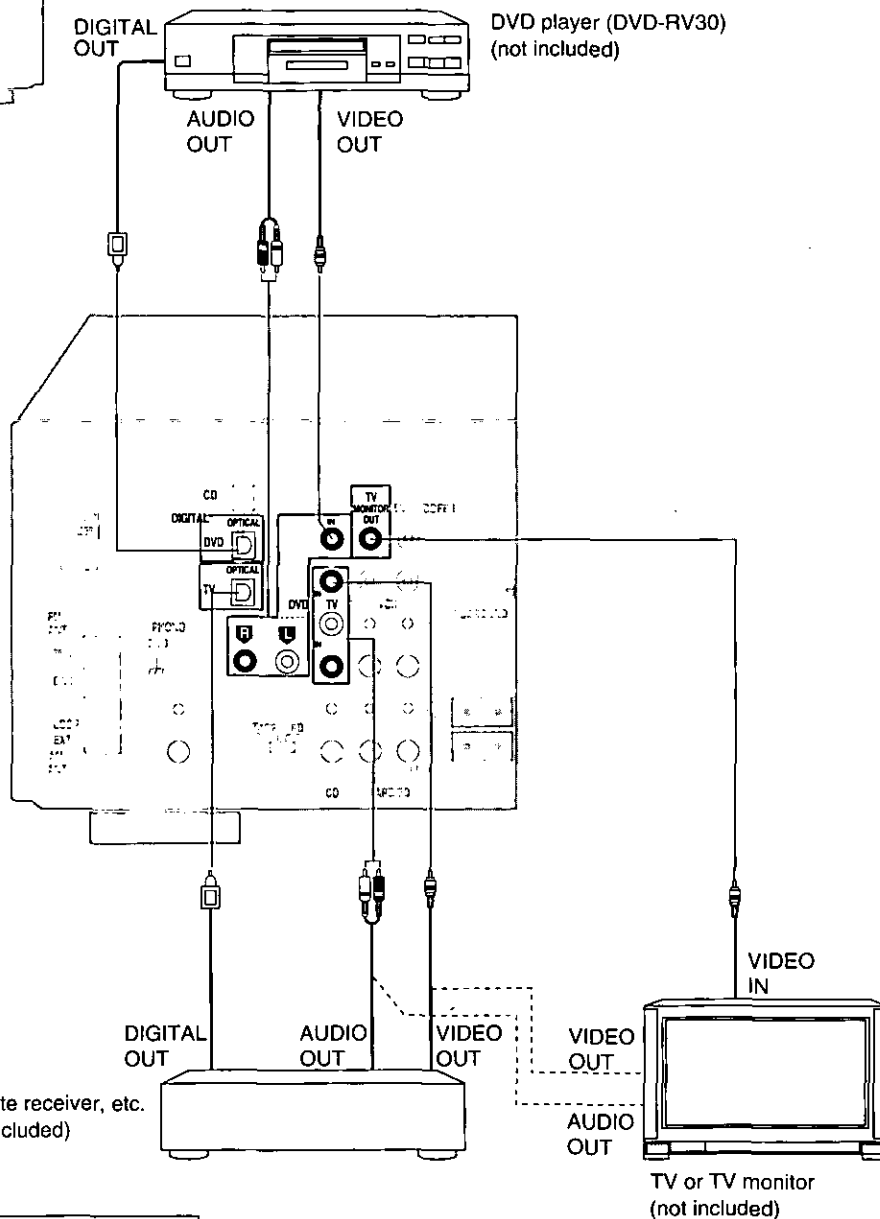

Note

Use digital connection to enjoy Dolby Digital or DTS (⇒ page 40).
 Analog connection is necessary if you intend to record the source (⇒ page 37).

CAUTION

Do not place anything on top of the receiver or block the heat radiation vents in any way.
 In particular, do not place tape decks or CD/DVD players on the receiver as heat radiated from it can damage your software.

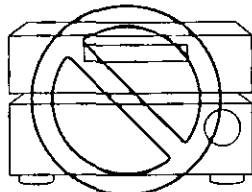

NO

Antenna connections

Before use

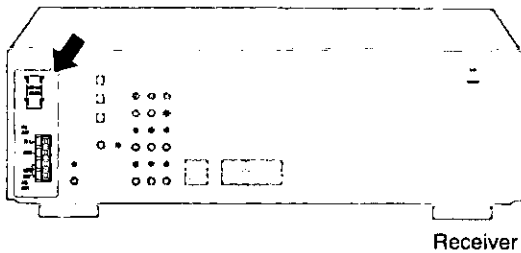

FM antenna

Fix the other end of the antenna where reception is best.

FM indoor antenna (included)

Adhesive tape (not included)

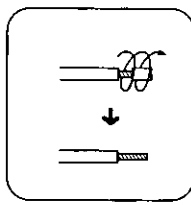

AM loop antenna

- Fit the AM loop antenna holder (included) onto the rear panel of this unit and then attach the AM loop antenna to the AM loop antenna holder (facing in the direction of best reception).
- Keep loose antenna cord away from other wire cords or a tape deck.

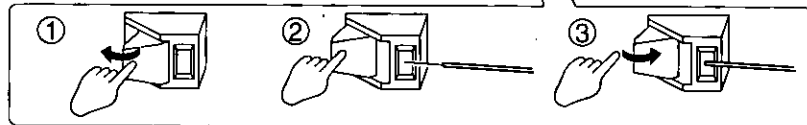
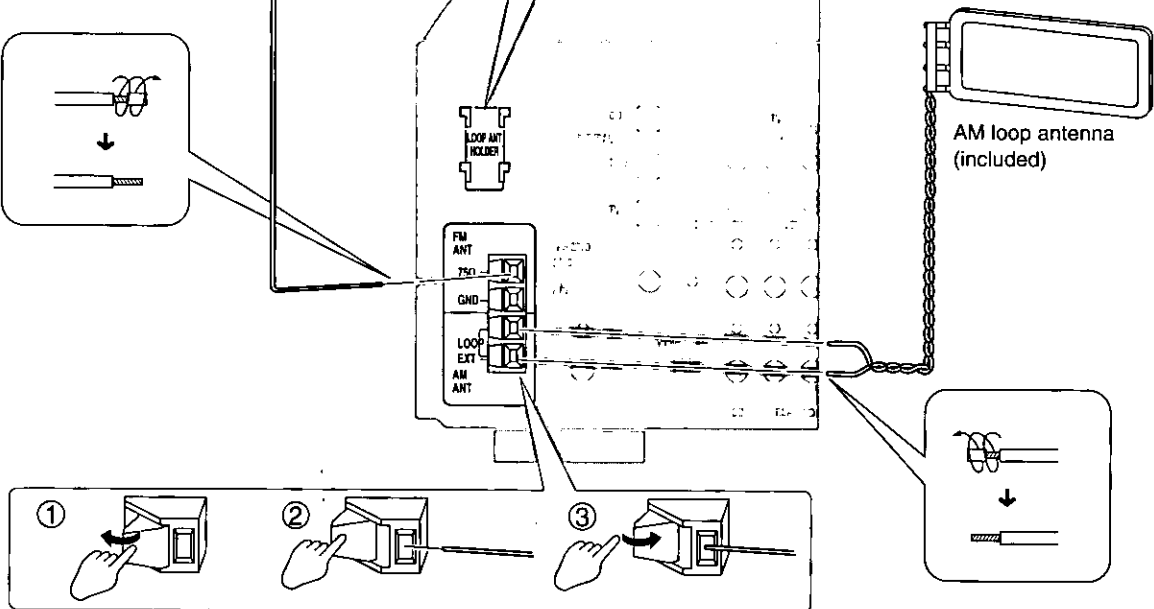
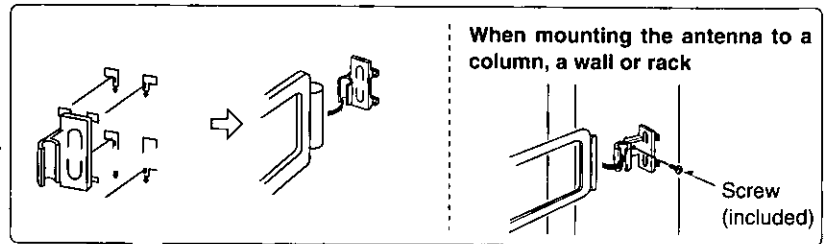

To connect an outdoor antenna

FM antenna

- Disconnect the FM indoor antenna.
- The antenna should be installed by a competent technician.
- Twist the coaxial cable's shield braid firmly and connect it to the GND terminal.

AM loop antenna

- Run a piece of vinyl wire horizontally across a window or other convenient location.
- Leave the loop antenna connected.
- Disconnect the antenna when the unit is not in use. Do not use the antenna during an electrical storm.

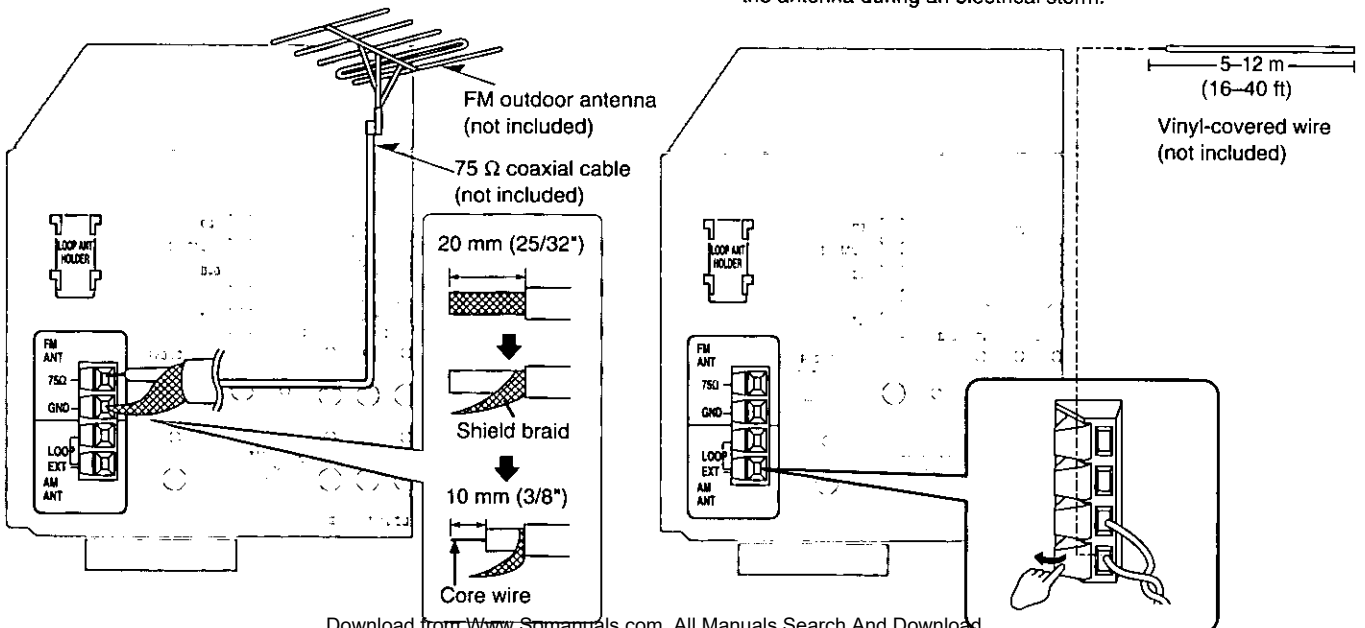

Speaker connections

Wall installation of the surround speakers

Note

The surface you attach the speakers to must be able to support over 8 kg (17.6 lb.). Please note that if the wall is not strong enough, it may result in a dangerous accident.

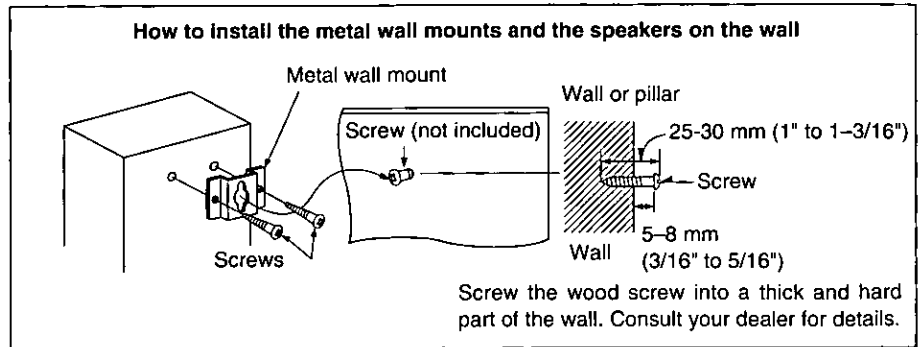

Before use

Connecting speakers

Connecting the cables

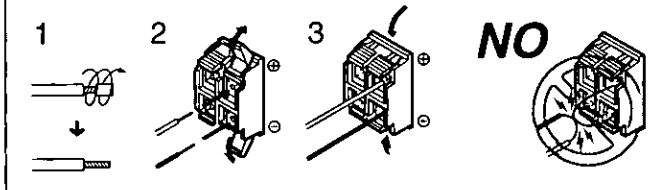

Caution

- Use the speakers only with the recommended system. Failure to do so may lead to damage to the amplifier and/or the speakers, and may result in the risk of fire. Consult a qualified service person if damage has occurred or if you experience a sudden change in performance.
- Do not attempt to attach these speakers to walls using methods other than those described in this manual.

Front speakers

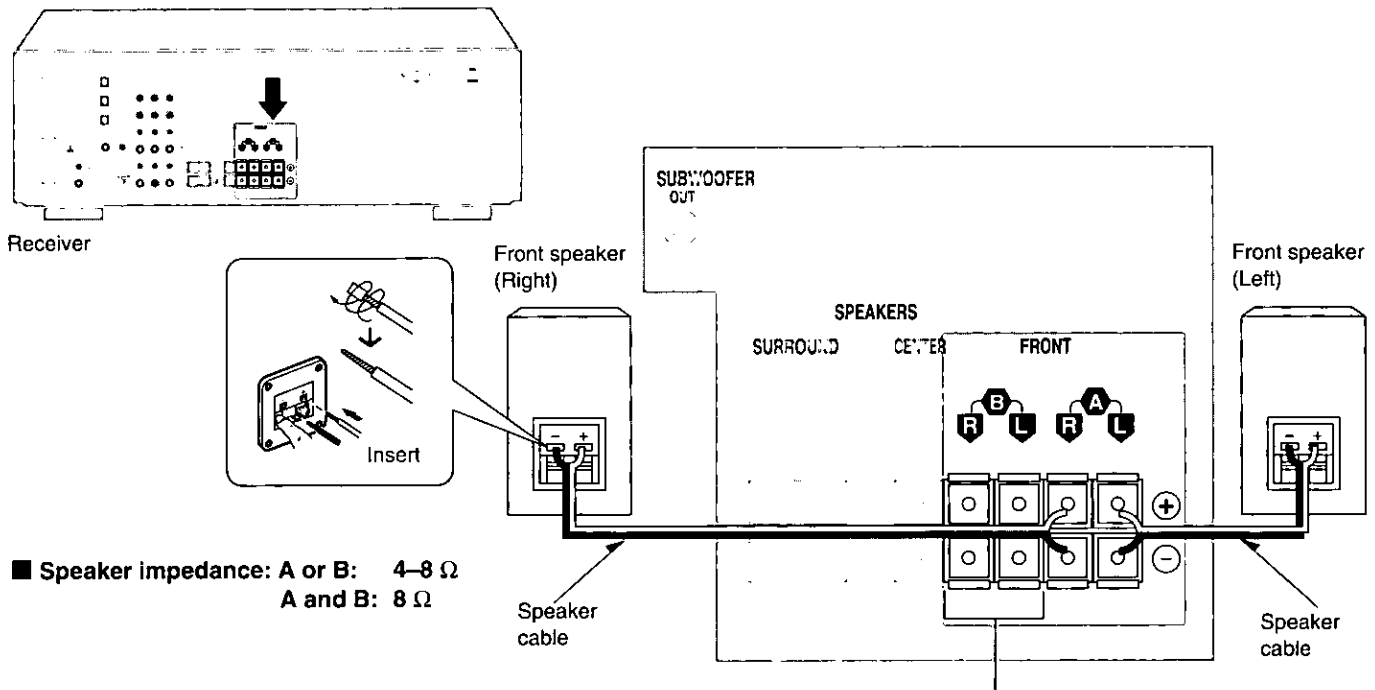

- **Speaker impedance: A or B:** 4–8 Ω
A and B: 8 Ω

■ Protection circuitry (For front speakers)

These units incorporate speaker protection circuitry to protect the speaker from damage caused by excessive input or abnormal signals; when excessive input is detected, input is automatically interrupted.

- If sound is interrupted or changed...

1. Reduce the volume of the receiver.
 2. Check the sound source and connections for any problems.
- If there is no problem, the protection circuitry will reset in a few minutes.

- After the protection circuit is reset...

Take care not to turn the receiver's volume up too high.

"B" terminals

For connection to a second pair of speakers.

Note

Use the A terminals to enjoy Dolby Digital, Dolby Pro Logic, DTS and SFC.

Speaker connections

Center speaker

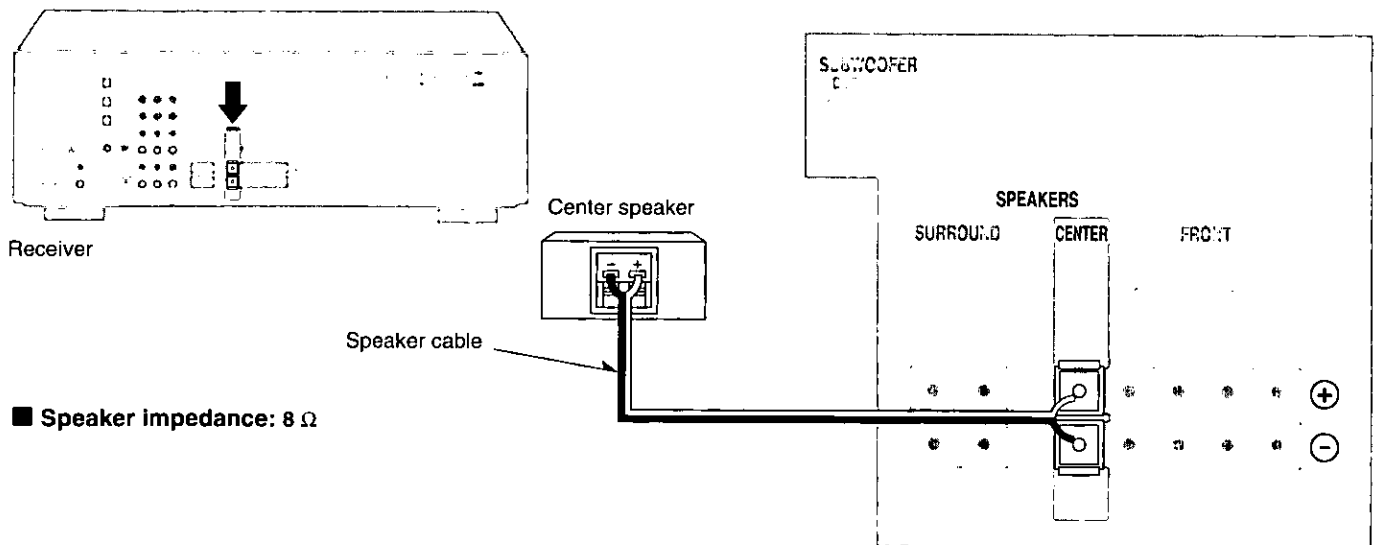

Surround speakers

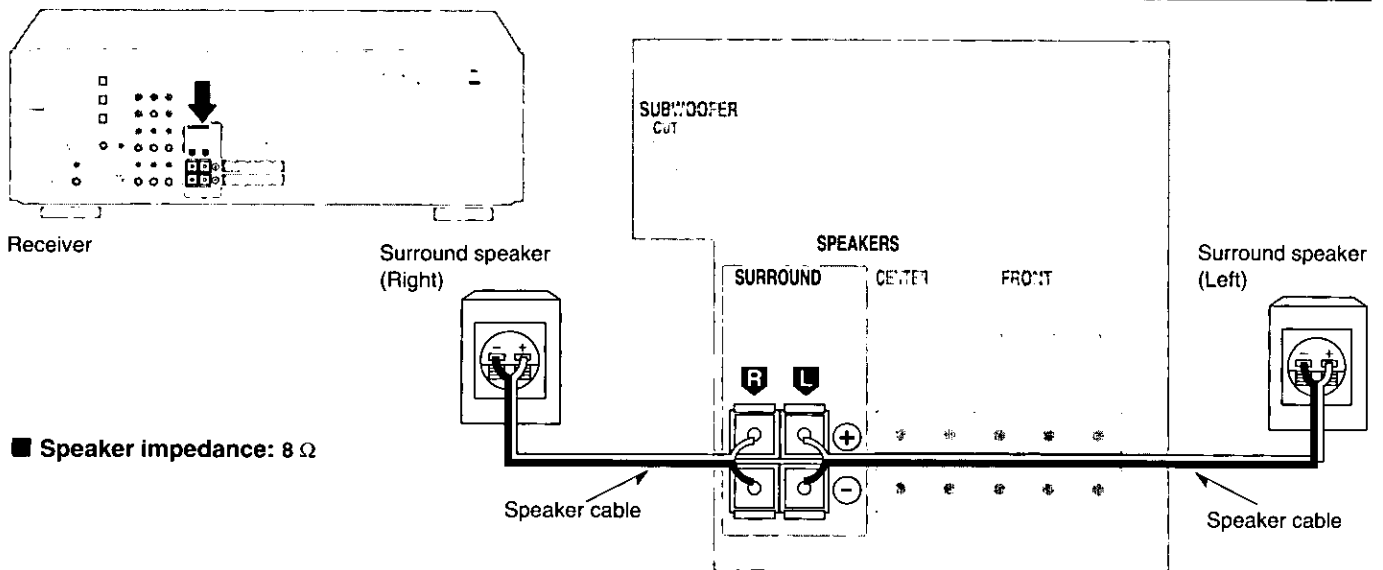

Subwoofer

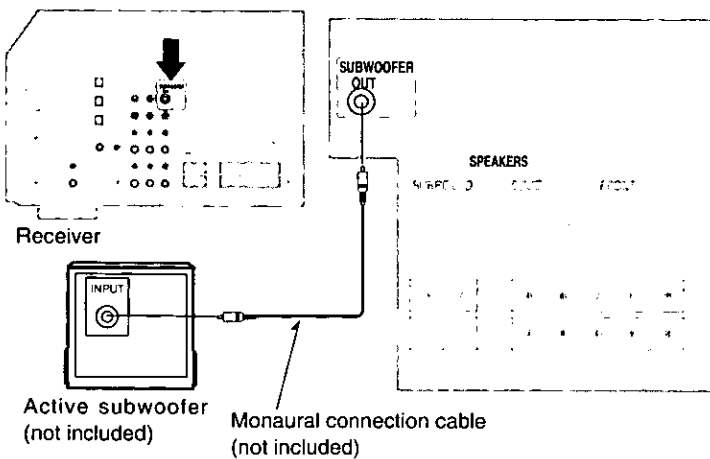

Note

This receiver has no amplifier section designed especially for the subwoofer.

To connect a passive subwoofer

- You can connect another amplifier and connect a passive subwoofer to it.
- Connection to a passive subwoofer that has front speaker terminals is also possible. (See the operating instructions of the subwoofer for details.)

Concerning the remote control

Battery installation

Use of batteries

- Align the poles (+ and -) properly when inserting the batteries. Press in and down towards the minus end.
- Do not mix old and new batteries or different types of batteries.
- Do not recharge ordinary dry cell batteries.
- Do not heat or disassemble the batteries. Do not allow them to contact flame or water.
- Remove the batteries if the unit is not to be used for a long time.
- Do not keep together with metallic objects such as necklaces.
- Do not use rechargeable type batteries.
- Do not use batteries if the covering has been peeled off.

Mishandling of batteries can cause electrolyte leakage which can damage items the fluid contacts and may cause a fire.

If electrolyte leaks from the batteries, consult your dealer.

Wash thoroughly with water if electrolyte comes in contact with any part of your body.

Correct method of use

Operation notes

- Do not place obstacles between the remote control signal sensor and remote control unit.
- Do not expose the remote control signal sensor to direct sunlight or to the bright light of a fluorescent light.
- Take care to keep the remote control signal sensor and end of the remote control unit free from dust.
- If this system is installed in a rack with glass doors, the glass doors' thickness or color might make it necessary to use the remote control a shorter distance from the system.

To prevent damage

- Never place heavy items on top of the unit.
- Do not disassemble or reconstruct the unit.
- Do not spill water or other liquids into the unit.

Concerning the liner notes organizer

Your changer comes with a liner notes organizer in which you can keep your CD liners. There are also numbered stickers to indicate slot numbers in the binder. This is a convenient way to keep track of what disc is in what slot.

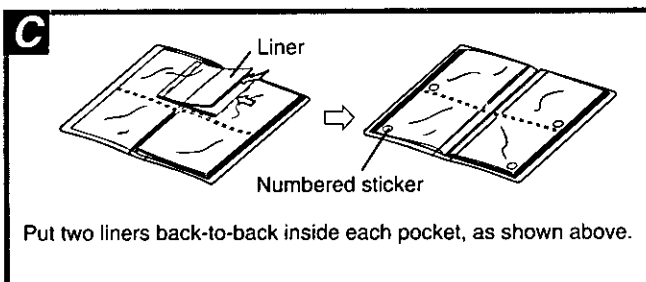
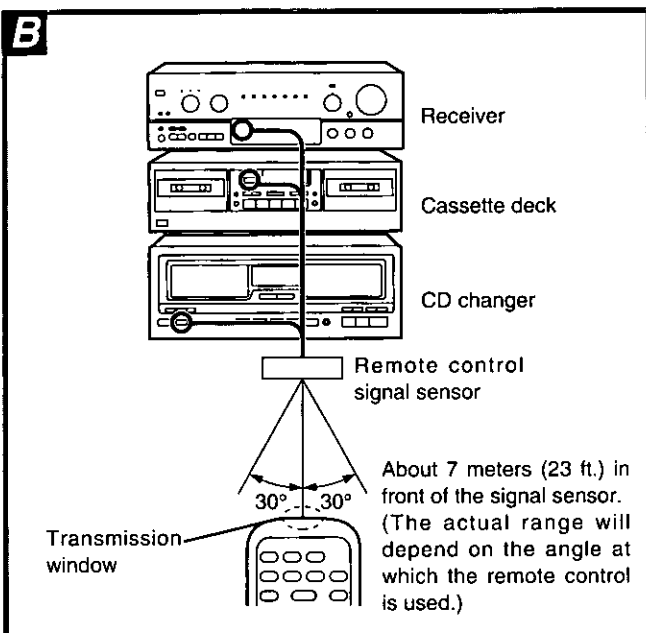
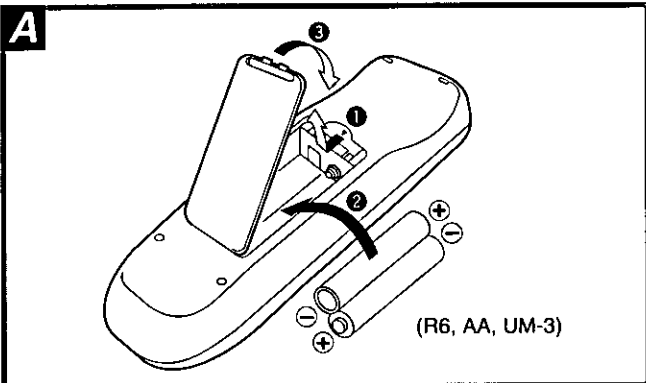

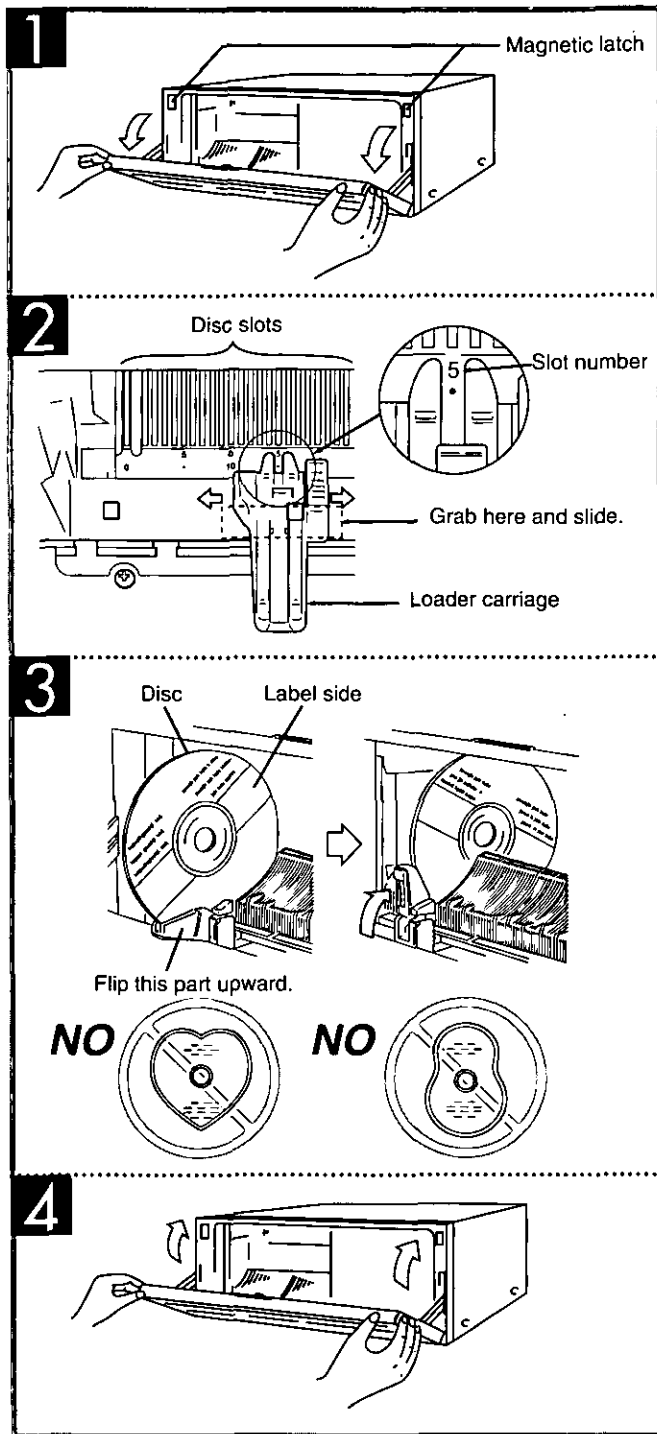
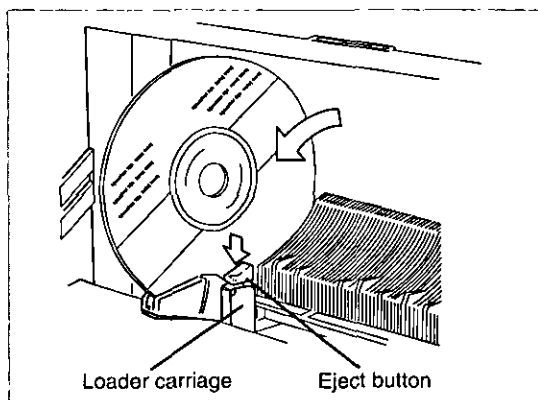
A**B****Setting/Removing discs****How to set discs****A**

- 1** Pulling gently from both ends, open the front panel.

Caution

- Except when setting or removing discs, keep hands out of the changer while open. You could injure yourself if somehow entangled in the internal mechanism.
- Keep cassette tapes away from the magnetic latches.

- 2** Slide the loader carriage to the slot No. where the disc is to be inserted.

Note

Slot No. 0 (SINGLE) is reserved for single disc play.
(→ page 23.)

- 3** Set the disc on the loader and flip the loader upwards.

Caution

- Do not use 3" (8 cm) discs fitted with expander rings. Expander rings could damage the disc slots.
- Do not use cleaning discs or warped discs. All of these could damage your changer.
- Do not use discs with poorly attached labels or stickers. Adhesive protruding from peeled off stickers can cause the changer to malfunction.
- Do not use irregular shape CDs (heart-shape, octagonal, etc.).
- Do not put anything other than discs in the changer.

- 4** Close the front panel gently.

Note

If you leave the front panel open while a disc is in play, the changer will stop when the disc is finished.

How to remove discs**B**

- 1.** Open the front panel.
- 2.** Slide the loader carriage to the slot you want.
- 3.** Press the eject button on the loader carriage.

Special notes

You can set and remove discs while another disc is playing.

- Do not set a disc in the slot of the disc being played (slot flashes). The disc in play is returned to its slot when finished. If two discs somehow jam the slot, they could be damaged. When this happens, the message "TAKE OUT" will appear on the display. Remove the disc that doesn't belong in the slot and press the stop button.
- Do not open the CD front panel and press the eject button when "CHECKING DISCS" appears in the display. The CD mechanism will be damaged if the eject button is pressed at this time.
- Sometimes the front panel cannot be opened while a disc is playing. In such case, wait until you can open it.

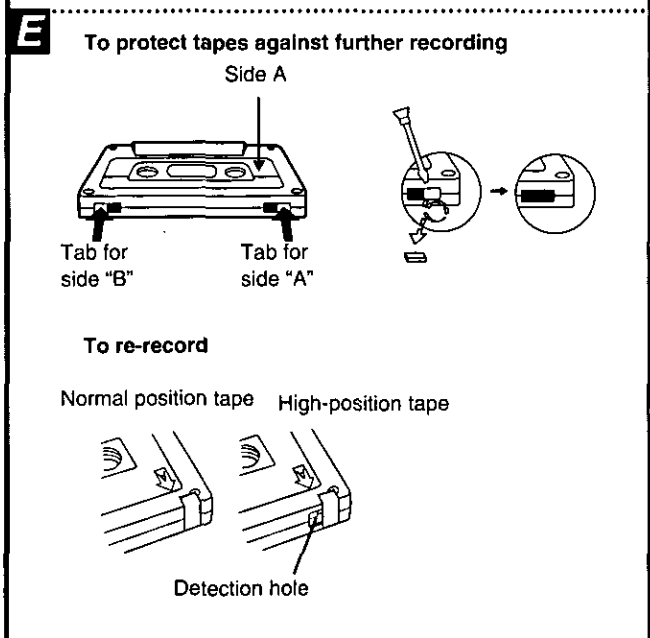
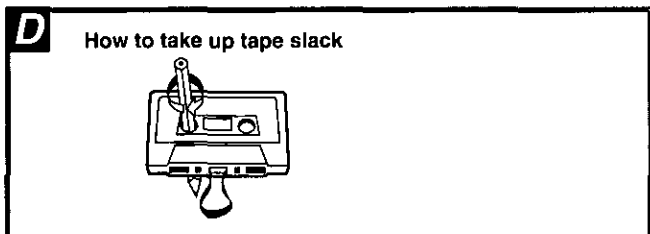
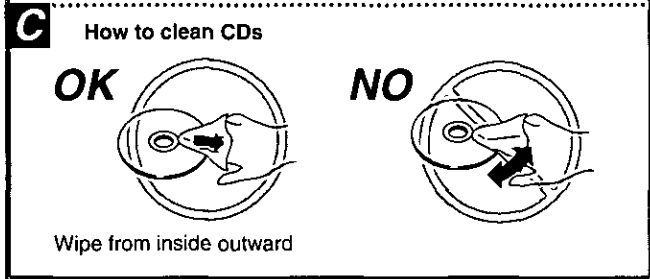
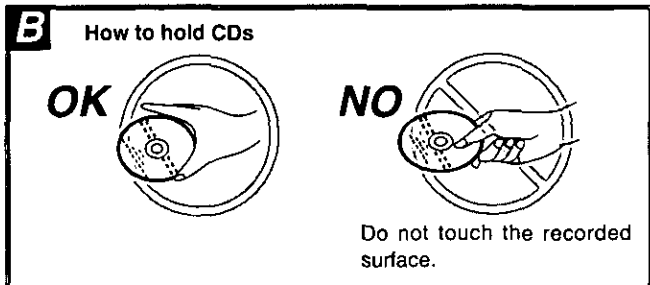
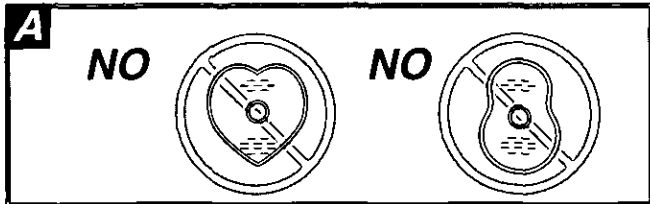

Concerning CDs

With this changer, you can only play CDs having this mark:
However, do not use irregular shape CDs. CDs of the sort can damage the unit. (A)



Handling precautions B - C

- If you are taking the CD from a cold to a warm environment, moisture may form on the CD. Wipe this off with a soft, dry, lint-free cloth before using the CD.
- Do not write on the label side with a ball-point or other writing instrument.
- Do not use record cleaning sprays, benzene, thinner, static electricity prevention liquids or any other solvent.
- Do not attach labels or stickers to CDs. (Do not use CDs with exposed adhesive from tape or left over peeled off stickers.)
- Do not use scratch-proof protectors or covers other than those specified for use with this system.
- Do not use CDs printed with label printers available on the market.

Storage precautions

Be sure to store CDs in their cases to protect them from dust, scratches, and warping.

Do not place or store CDs in the following places

- Locations exposed to direct sunlight
- Humid or dusty locations
- Locations directly exposed to a heat vent or heating appliance
- In the glove compartment or on the rear deck of an automobile

Concerning cassette tapes

Selection of cassette tapes

Tapes can get caught on the capstans. Use caution with the following types of tapes.

Cassette tapes exceeding 100 minutes

These tapes are made of a thin film material. Do not repeatedly advance and stop the tape, fast-forward it or rewind it.

Endless-tapes

For this unit, it is recommended to use tapes which are appropriate to the auto reverse mechanism.

Always read the instructions provided with your tapes.

Tape slack D

Tape slack may cause the tape to break.

Erasure prevention E

Use a screwdriver or similar object to break out the tab.

To re-record on a protected cassette

Cover the hole with adhesive tape.

Do not cover the detection hole on high-position tapes.

Storage precautions

Do not place or store tapes in the following places;

- In high temperature (95°F/35°C or higher) or high humidity (80% or higher) areas
- In a strong magnetic field (near a speaker, on top of a TV, etc.) This can erase a recording.
- Locations exposed to direct sunlight

A

Before use

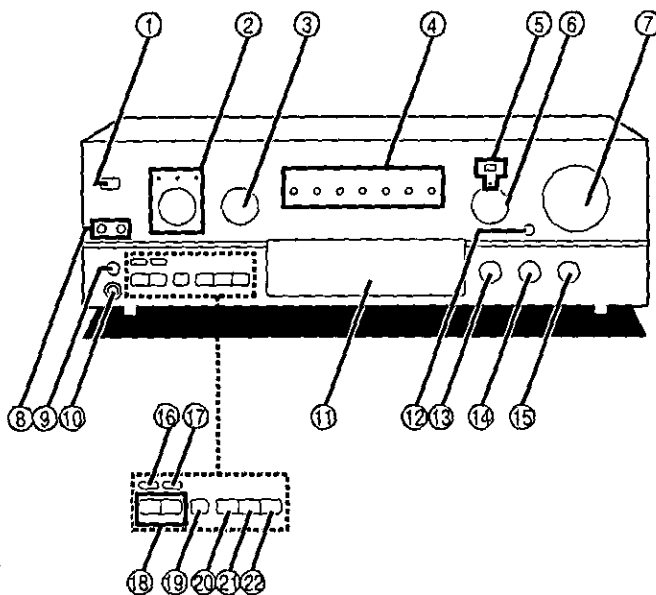
**Front panel controls**

No.	Name	Ref. page
-----	------	-----------

Receiver

- | | | |
|---|---|----|
| ① | Power "⏻/⏻" switch (POWER, ⏻/⏻) | 18 |
| | Press to switch the unit from on to standby mode or vice versa. In standby mode, the unit is still consuming a small amount of power. | |
| ② | DSP mode selector (DSP) | 40 |
| ③ | SFC mode selector (SFC MODE) | 42 |
| ④ | Input indicators (INPUT) | |
| ⑤ | Digital input select button/indicator (DIGITAL INPUT) | 22 |
| ⑥ | Input selector (INPUT SELECTOR) | 18 |
| ⑦ | Volume control (VOLUME) | 18 |
| ⑧ | Speaker select buttons (SPEAKERS A, B) | 18 |
| ⑨ | Help/reset button (-HELP, -RESET) | 53 |
| ⑩ | Headphones jack (PHONES) | 35 |
| ⑪ | Display | |
| ⑫ | Tape monitor button (TAPE MONITOR) | 18 |
| ⑬ | Bass control (BASS) | 35 |
| ⑭ | Treble control (TREBLE) | 35 |
| ⑮ | Balance control (BALANCE) | 35 |
| ⑯ | Digital signal processor on/defeat button (-DSP ON/DEFEAT) | 18 |
| ⑰ | Subwoofer button (SUBWOOFER) | 36 |
| ⑱ | Tuning buttons (TUNING ∇, ▲) | 18 |
| ⑲ | Presetting button (PRESET) | 21 |
| ⑳ | Band select button (BAND) | 18 |
| ㉑ | FM mode select button (FM MODE) | 18 |
| ㉒ | Memory button (MEMORY) | 20 |

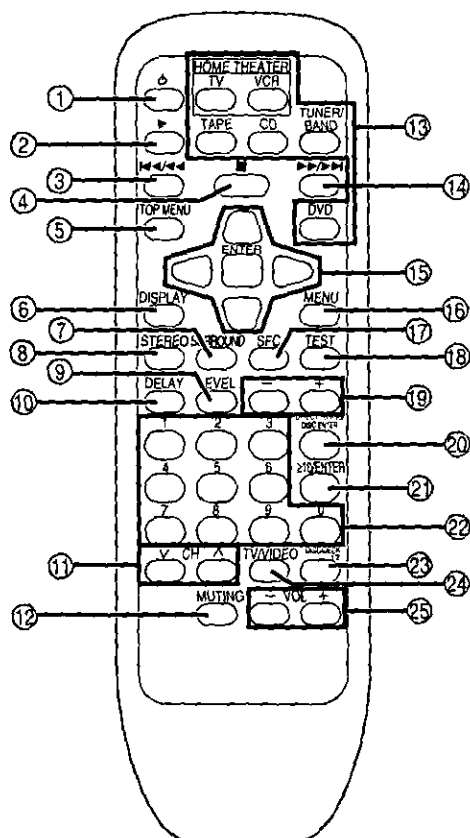
B**Remote control**

- | | | |
|---|--|--------|
| ① | Power button (⏻) | 44 |
| ② | ▶ button (▶) | 45 |
| ③ | ◀◀/▶▶ button (◀◀/▶▶) | 45 |
| ④ | ■ button (■) | 45 |
| ⑤ | Top menu button (TOP MENU) | 49 |
| ⑥ | Display button (DISPLAY) | 49 |
| ⑦ | Surround mode select button (SURROUND) | 44 |
| ⑧ | Stereo mode select button (STEREO) | 44 |
| ⑨ | Speaker channel select button (LEVEL) | 41, 44 |
| ⑩ | Delay time button (DELAY) | 43, 44 |
| ⑪ | Channel up/down buttons (∇CH/▲) | 45 |
| ⑫ | Muting button (MUTING) | 35, 44 |
| ⑬ | Input select buttons (TV, VCR, TAPE, CD, TUNER/BAND, DVD) | 44 |
| ⑭ | ▶▶/▶▶▶▶ button (▶▶/▶▶▶▶) | 45 |
| ⑮ | Cursor/enter buttons | 49 |
| ⑯ | Menu button (MENU) | 49 |
| ⑰ | SFC mode select button (SFC) | 44 |
| ⑱ | Test button (TEST) | 41, 44 |
| ⑲ | Delay time/level adjust buttons (-, +) | 41, 44 |
| ⑳ | Direct tuning/disc enter button (DIRECT TUNING/DISC ENTER) | 19, 45 |
| ㉑ | ≥10/enter button (≥10/ENTER) | 24, 45 |
| ㉒ | Numbered buttons | 19, 45 |
| ㉓ | Disc/deck 1/2 select button (DISC/DECK 1/2) | 45 |
| ㉔ | TV/video select button (TV/VIDEO) | 47 |
| ㉕ | Volume buttons (-VOL+) | 41, 44 |

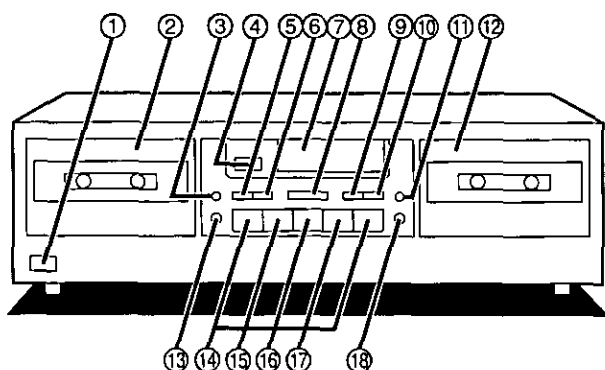
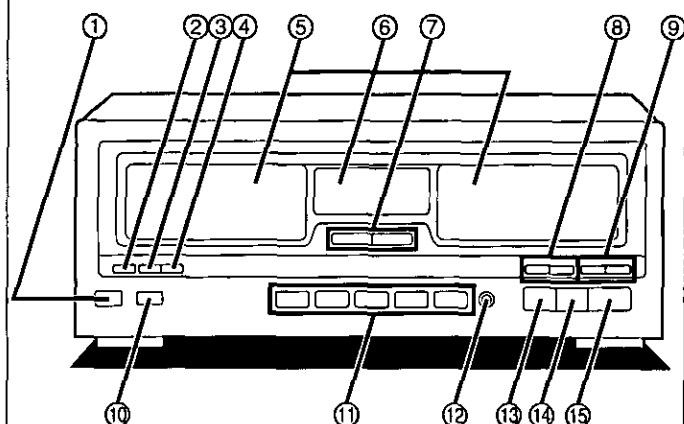
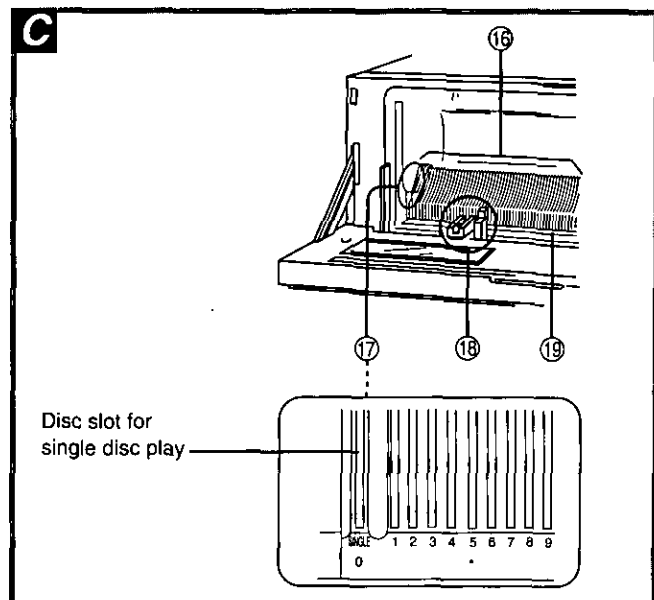
A**B****C****Front panel controls**

No.	Name	Ref. page
-----	------	-----------

Cassette deck**A**

- | | | |
|---|---|----|
| ① | Power "STANDBY ϕ /ON" switch (POWER, STANDBY ϕ /ON)..... | 31 |
| | Press to switch the unit from on to standby mode or vice versa. In standby mode, the unit is still consuming a small amount of power. | |
| ② | Cassette holder for deck 1 | |
| ③ | Counter reset button (COUNTER RESET) | 34 |
| ④ | Remote control signal sensor (SENSOR) | 13 |
| ⑤ | Synchro-start button (SYNCHRO START)..... | 38 |
| ⑥ | Tape-to-tape recording-speed button (SPEED NOR/Hi)..... | 38 |
| ⑦ | Display | |
| ⑧ | Tape deck select button (DECK 1/2) | 32 |
| ⑨ | Dolby noise-reduction button (DOLBY NR)..... | 31 |
| ⑩ | Reverse-mode select button (REVERSE MODE) | 31 |
| ⑪ | Rec pause button (● REC PAUSE)..... | 37 |
| ⑫ | Cassette holder for deck 2 | |
| ⑬ | Open button for deck 1 (▲ OPEN)..... | 31 |
| ⑭ | Rewind/fast-forward buttons (◀◀, ▶▶) | 34 |
| ⑮ | Reverse-side playback button (◀)..... | 31 |
| ⑯ | Stop button (■) | 32 |
| ⑰ | Forward-side playback button (▶) | 31 |
| ⑱ | Open button for deck 2 (▲ OPEN)..... | 37 |

CD changer**B**

- | | | |
|---|---|----|
| ① | Power "STANDBY ϕ /ON" switch (POWER, STANDBY ϕ /ON) | 22 |
| | Press to switch the unit from on to standby mode or vice versa. In standby mode, the unit is still consuming a small amount of power. | |
| ② | Single disc play button (SINGLE ▶) | 23 |
| ③ | Direct programming button (DIRECT) | 29 |
| ④ | Programming button (PROGRAM) | 28 |
| ⑤ | Windows | |
| ⑥ | Display | |
| ⑦ | Disc skip buttons (DISC SKIP, -, +) | 23 |
| ⑧ | Search buttons (◀◀, ▶▶) | 23 |
| ⑨ | Track skip buttons (◀◀, ▶▶) | 23 |
| ⑩ | Remote control signal sensor (SENSOR) | 13 |
| ⑪ | Disc group buttons (DISC GROUPING PLAY, A, B, C, D, E) | 25 |
| ⑫ | Group enter button (GROUP ENTER) | 25 |
| ⑬ | Stop button (■) | 22 |
| ⑭ | Pause button () | 22 |
| ⑮ | Play button (▶) | 22 |

Disc slot section**C**

For an explanation on how to open the front panel, see page 14 "How to set discs".

- | | | |
|---|---|--|
| ⑮ | Disc slots | |
| ⑰ | Disc slot for single disc play (SINGLE) | |
| ⑱ | Loader carriage | |
| ⑲ | Slot numbers | |

Before use

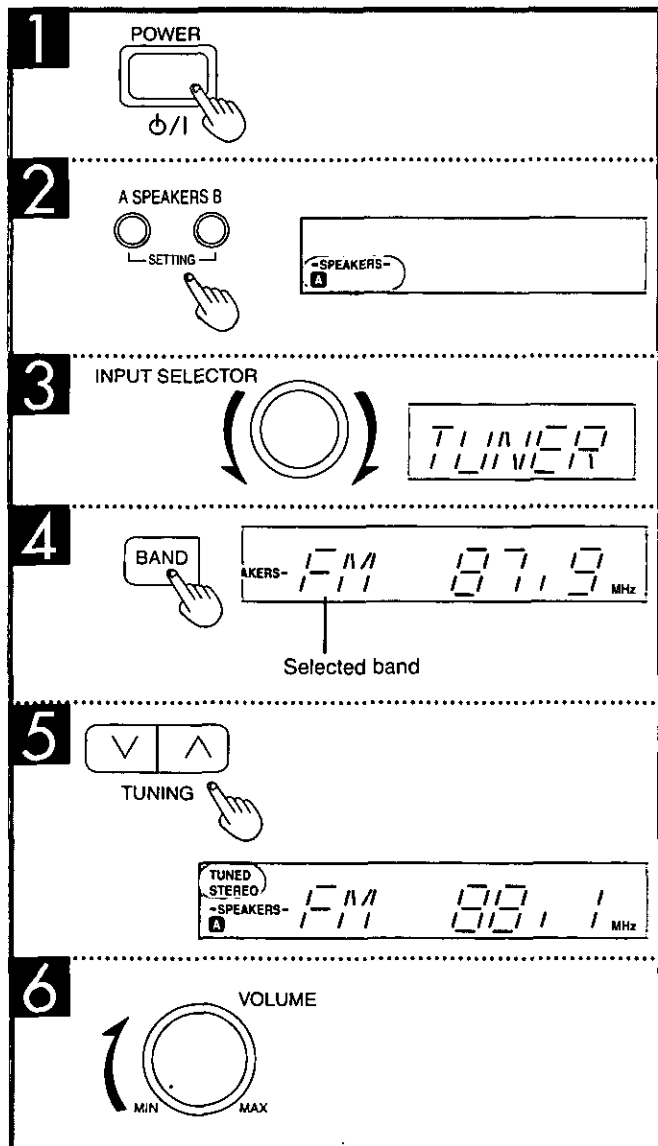
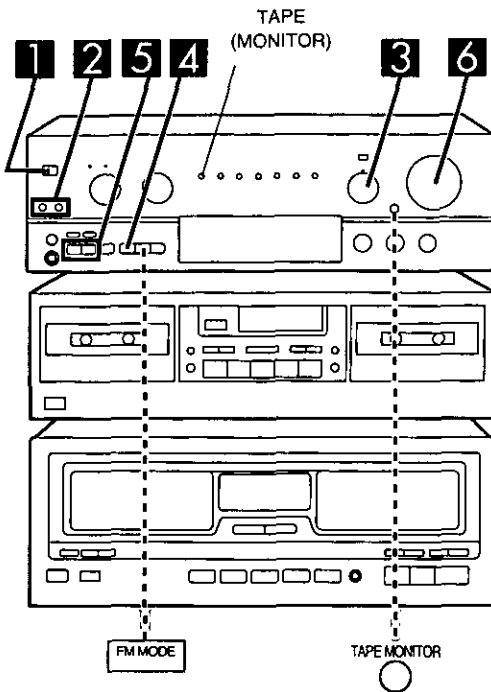

Listening to radio broadcasts

To listen to the radio without presetting stations

Sequential tuning

Use the tuning buttons to tune-in radio stations.

Before operation, set [VOLUME] to the "MIN" position.

- 1** Press [POWER] on the receiver.
- 2** Press [A] to turn on SPEAKERS A.
If the button is pressed once more, the indicator will switch off and no sound will be heard from the speakers.
- 3** Turn [INPUT SELECTOR] to select "TUNER".

If the "TAPE (MONITOR)" indicator and another source indicator are on, press [TAPE MONITOR] and check the indicator goes out.
If you are using a graphic equalizer, turn TAPE (MONITOR) on.

- 4** Press [BAND] to select "FM" or "AM".
- 5** Press [TUNING (V) or (^)] to tune to the desired frequency.

"TUNED" lights up when tuned.

"STEREO" lights up when an FM stereo broadcast is received.

To make an automatic search for a station

If [TUNING (V) or (^)] is held down for an instant until the frequency begins to scroll, the stations are tuned in automatically when one is found.

Note

Tuning may stop automatically if any jamming is encountered.

- 6** Adjust the volume.

If noise is excessive in the FM stereo mode

Press [FM MODE].

("STEREO" will go out, and "MONO" will light up.)

The broadcast will be monaural, but noise will be reduced.

If the button is pressed once more, the stereo mode resumes.

If there is hissing or thumping while the radio is playing

Press and hold [-DSP ON/DEFEAT] to select "DEFEAT".

(→ Page 42 for details about DSP DEFEAT)

For your reference

The tuner can pick up interference from DVD players. If this occurs turn the DVD player off.

When you finish listening

Be sure to reduce the volume, and switch the power to the standby condition by pressing [POWER] of the receiver.

The power for the system can thereafter be switched between on and the standby condition by using the power switch of the receiver (provided that the power cords are connected as on page 7).

Direct tuning

by remote control only

Specify the frequency using the numeric buttons on the remote control to directly tune to the station.

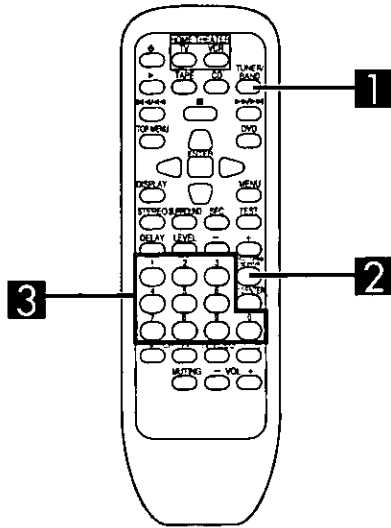

1 Press [TUNER/BAND].

This will set the remote control to operate the tuner. The selector on the receiver will change to "TUNER". Each time the button is pressed, the band will change as follows, FM \rightleftharpoons AM.

2 Press [DIRECT TUNING/DISC ENTER].

3 While cursor display is flashing (approx. 10 seconds) Press the numbered buttons to enter the frequency.

If the desired FM frequency is 107.9 MHz, press

[1] \rightarrow [0] \rightarrow [7] \rightarrow [9].

If the frequency has been input correctly, the displayed frequency will blink once.

Note

1. If no button is pressed while the cursor display is flashing, the display will return to the frequency which is currently being received. To re-specify the frequency, repeat the procedure from step 2.
2. If the frequency has not been input correctly, "ERROR" will be displayed. In this case, re-enter the frequency.

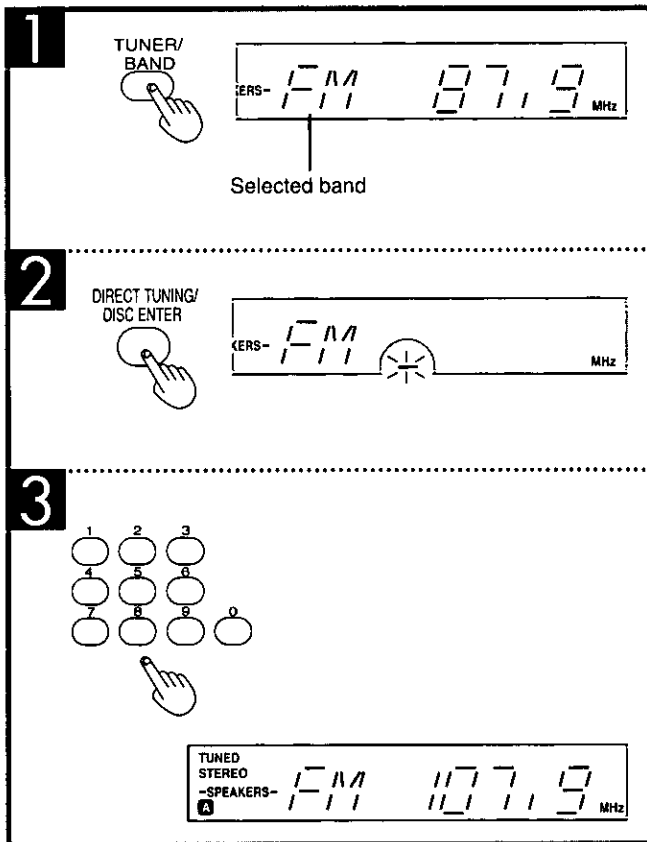

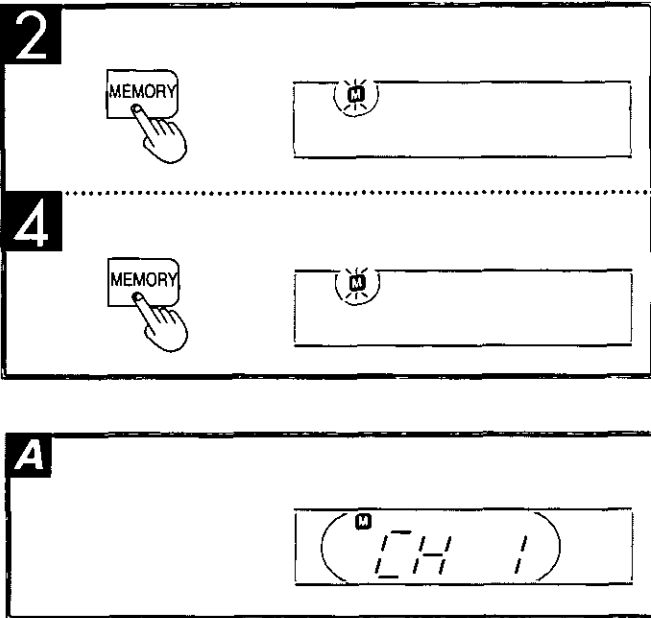
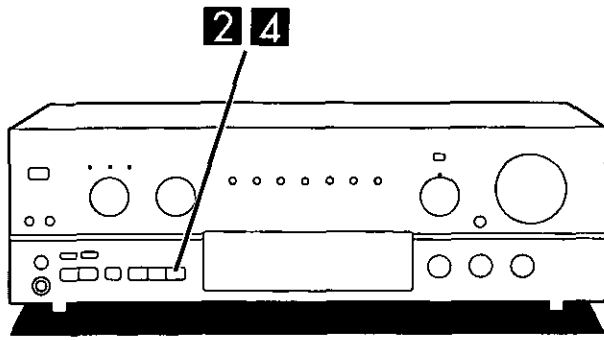

Listening to radio broadcasts

Preset tuning

Presetting radio stations into the memory channels of this unit makes selecting stations simple.

A total of 30 FM and AM stations can be preset.

Please remember this

If a new station is preset into a channel, the setting for the station which was previously entered in that channel will be automatically erased.

Automatic memory presetting

Automatic memory presetting allows this unit to search for stations and then preset them into memory.

1 Turn to the lowest frequency in FM.
(⇒ Page 18–19.)

2 Press and hold [MEMORY].
Automatic memory presetting will start.
All the FM stations the unit can receive are preset in channels 1 to 30.

3 Turn to the lowest frequency in AM.
Holding the buttons down lets you scroll through channels faster.
(⇒ Page 18–19.)

4 Press and hold [MEMORY].
Automatic memory presetting will start.
All the AM stations the unit can receive are preset in channels 21 to 30. (Any FM stations in these channels will be replaced.)

When a station is preset

The memory indicator and the preset channel number will be displayed for approximately 1 second. (A)

When presetting is completed

The last station to be preset will be displayed.

Note

Frequencies may not be preset correctly in cases where the broadcast waves are too strong or too weak. In such cases, carry out presetting manually (⇒ Page 21).

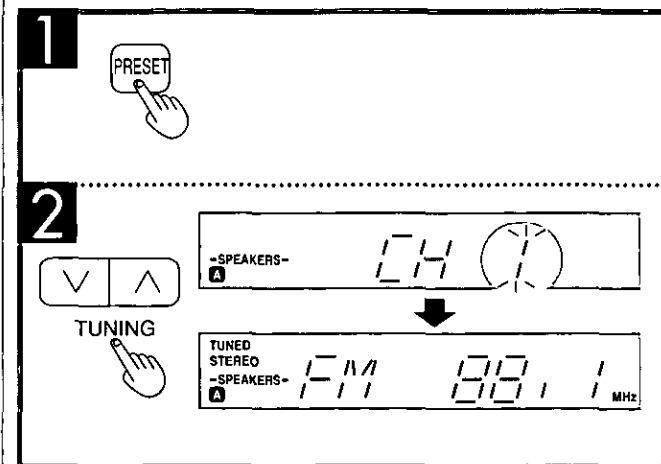
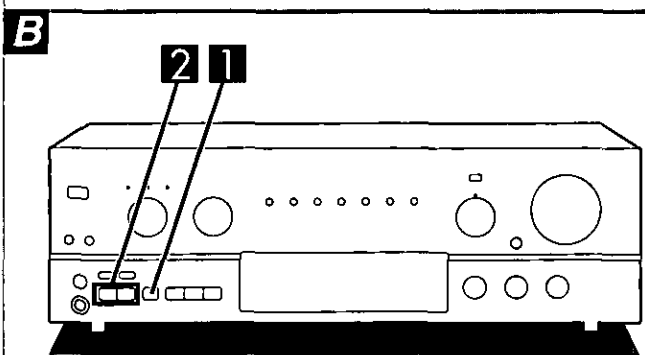
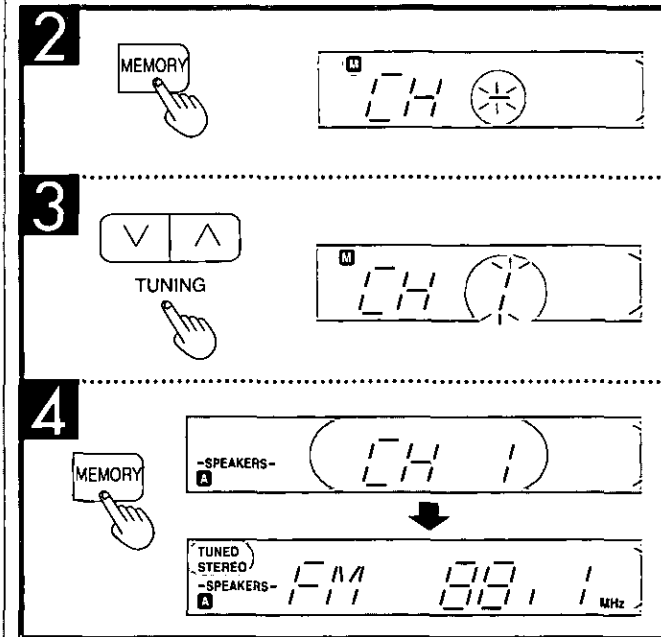
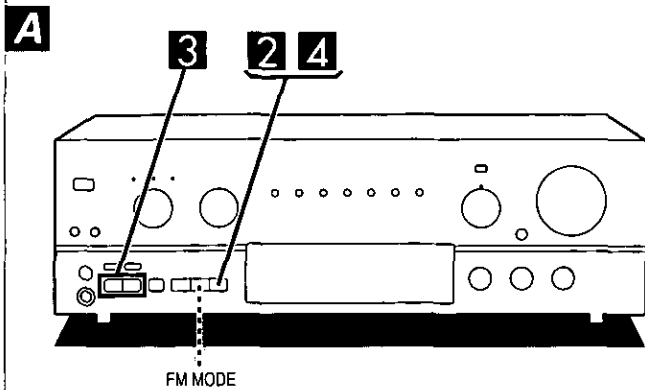

Listening to radio broadcasts

Manual memory presetting **A**

The desired stations can be preset into the desired channels by the user.

- 1 Set to the desired frequency.**
(→ Page 18–19.)

If interference or static is keeping you from enjoying an FM broadcast, press [FM MODE] and change to monaural. You can preset the station in monaural just as in stereo.

- 2 Press [MEMORY].**
To cancel the memory function, press [MEMORY] again.
- 3 Press [TUNING (V) or (^)] to select the desired channel.**
Holding the buttons down lets you scroll through channels faster.
- 4 Press [MEMORY].**
The channel will blink on the display.

To continue presetting
Repeat steps 1 through 4.

To listen to preset channels **B**

- 1 Press [PRESET].**
- 2 Press [TUNING (V) or (^)].**
Holding down the buttons lets you scroll through channels faster.

The channel number flashes for approximately 5 seconds. Select the desired channel number during that time. After 5 seconds, the display will change from the channel number to the frequency.

Note

If you press [PRESET] while the channel number is displayed, the display will change to the frequency.

To confirm the channel number of the station being received

Press [PRESET].
(The channel number flashes for approximately 5 seconds.)

Note

The channel number is not displayed if you change the frequency or FM mode setting.

For your reference

Even if the power supply cord is disconnected from the household AC outlet, the memory will retain its contents for approximately one month.

If frequency presettings are accidentally erased

Program the presettings once again.
The power supply cord should remain connected for one hour or more for the memory back-up to be effective.

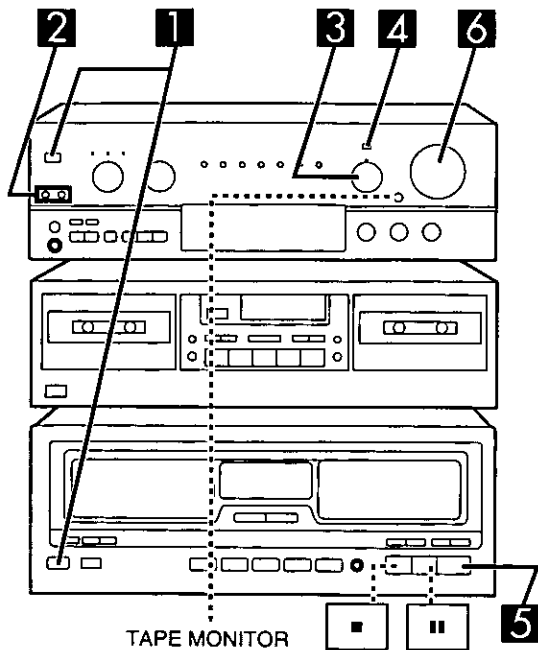

TAPE MONITOR

1

POWER

POWER

STANDBY \odot / ON

DISC
CHECKING

↓

DISC

2

A SPEAKERS B

SETTING

SPEAKERS
A

3

INPUT SELECTOR

CD

4

DIGITAL INPUT

ANALOG

DIGITAL → ANALOG

5

▶

On the CD changer's display

Disc number in play Play indicator

TRACK MIN SEC

Elapsed play time

6

VOLUME

MIN MAX

Listening to compact discs

Sequential play

The changer plays all the tracks on all the discs in order and stops automatically when the last track on the last disc finishes playing.

Before starting, load your discs (⇒ Page 14).

- 1** Press [POWER] on the receiver and CD changer. First switch on the power of the receiver.

The unit will switch on. Momentarily, the message "CHECKING DISCS" will appear on the display. When it goes out, the last disc played will be displayed.

If the "TAPE (MONITOR)" indicator and another source indicator are on, press [TAPE MONITOR] and check the indicator goes out. If you are using a graphic equalizer, turn TAPE (MONITOR) on.

- 2** Press [A] to turn on SPEAKERS A. If the button is pressed once more, the indicator will switch off and no sound will be heard from the speakers.
- 3** Turn [INPUT SELECTOR] to select "CD".
- 4** Press [DIGITAL INPUT] to select "ANALOG". Each time the button is pressed the display switches.
- 5** Press [▶]. Play will begin.
- 6** Adjust the volume.

To stop play

Press [■]. The display will show the total number of track and the total playing time of the current disc. (⇒ page 23.) Press [▶] to re-start play.

Note

It takes roughly 3 seconds from the time you press [■] until the disc is returned to the slot.

To temporarily stop play

Press [⏸]. The "⏸" indicator will light up. Press [▶] to resume play.

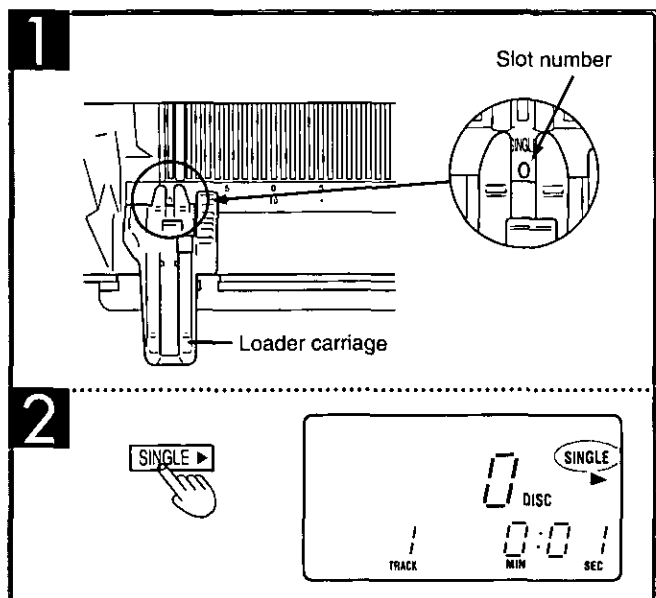
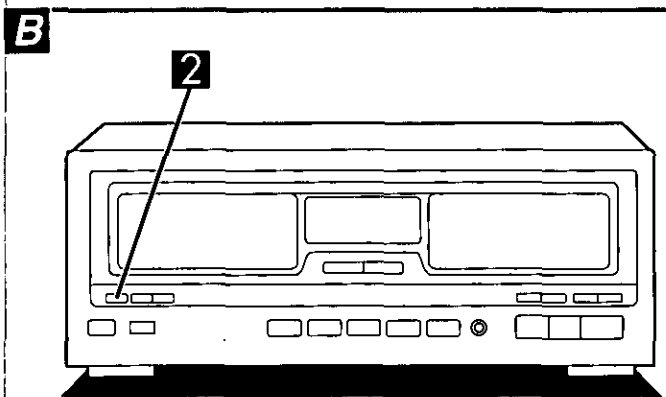
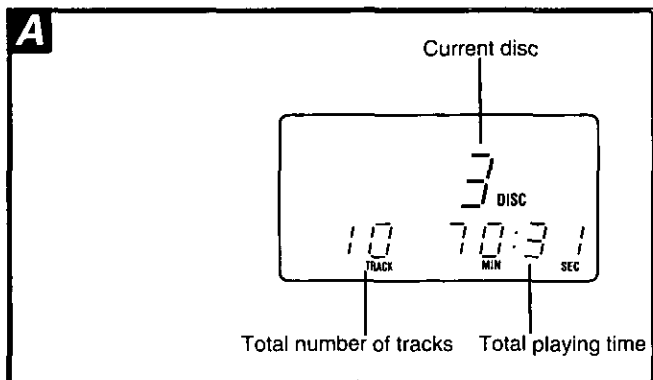
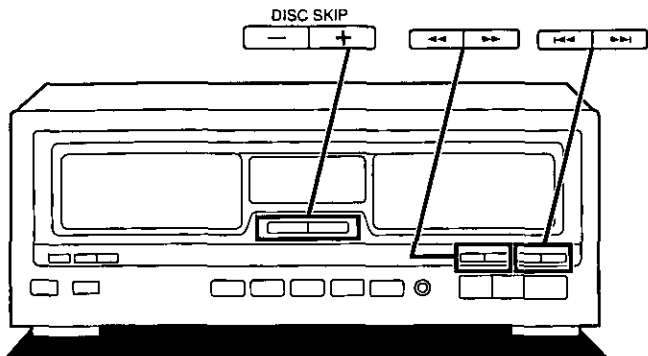

Listening to compact discs

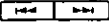
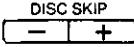
To search for the desired position	
To skip tracks	
To skip discs	

Displayed information when play is stopped

The total playing time displayed includes the silent sections between tracks. For this reason, it may be a few seconds longer than the playing time indicated on the disc.

When you open the front panel, the total number of tracks and the total playing time go out.

After listening is finished

Be sure to reduce the volume level, and switch the power to the standby condition by pressing [POWER] on the receiver.

Single disc play

Single disc play is convenient when you want to playback a specific disc right away, without going through the usual selection procedure, for example, to listen to a disc you just bought.

- 1** Open the front panel, and set the disc in slot No. 0. Face the label to the right and flip the loader upwards to set the disc.
- 2** Close the front panel and press [SINGLE ].

The changer plays all the tracks in order and stops automatically when the last track finishes playing.

To cancel single disc play mode

- Skip to another disc with [DISC SKIP (-) or (+)].
- Select a group.
- Select another disc with the numeric buttons of the remote control.

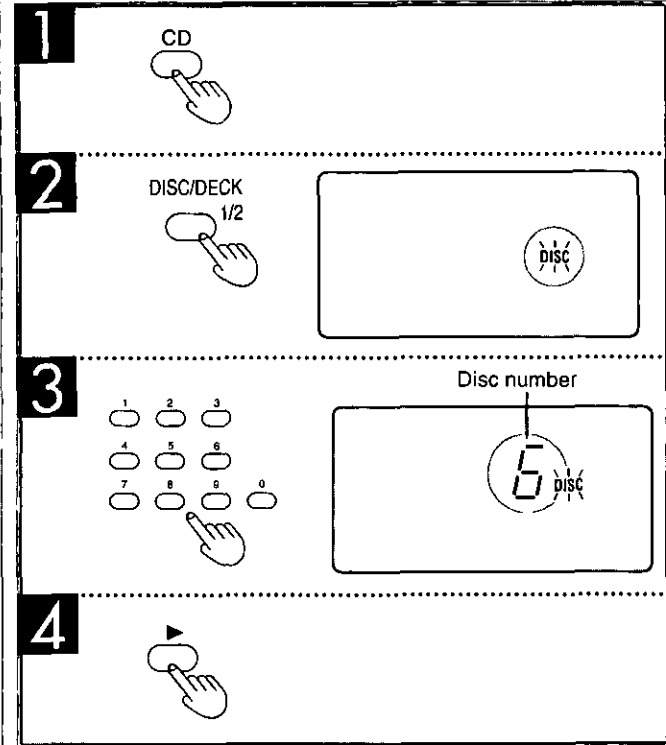
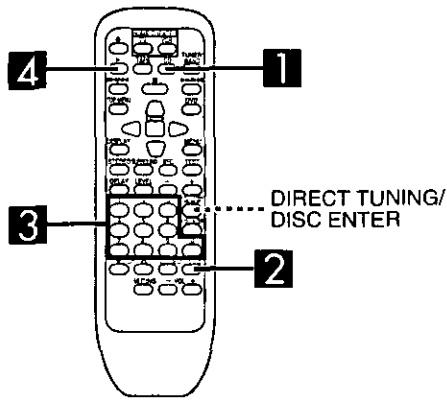
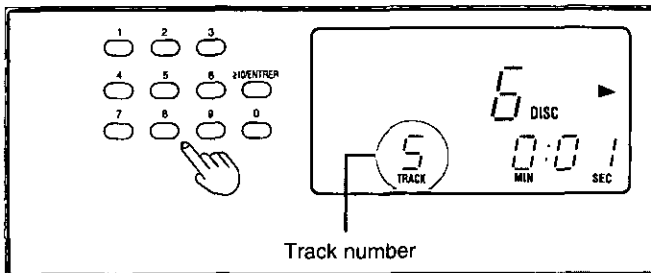
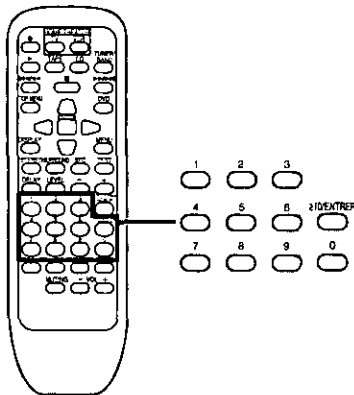
A**B**

Listening to compact discs

Direct access play

(Only available from the remote control.)

To directly access a specific disc **A**

- 1** Press [CD].
This will set the remote control to operate the CD changer.
- 2** Press [DISC/DECK 1/2].
- 3** [Within 7 seconds]
Select the disc you want with the numbered buttons.

To select a disc from 1 to 9
For example: "6"
[6]

To select a disc from 10 or higher
For example: "19"
[1] → [9]
Push the buttons within 7 seconds of each other.

Note

When selecting discs, [≥10/ENTER] does not respond to touch.

- 4** [Within 7 seconds]
Press [▶].
The changer will start playing the selected disc from the first track.

For your reference

- If you press [DIRECT TUNING/DISC ENTER] instead of [▶] to select a disc, the disc number will be displayed but play will not start automatically.
- When in the stop mode, if you select an empty slot, the message "NO DISC" will appear on the display.
- While a disc is playing, if you select an empty slot, the changer will automatically play the next disc available.
- If you select "0", the changer will switch to the single disc play mode.

To directly access a specific track **B**

After selecting a disc, select a track with the numbered buttons.

Press the numbered button(s) to select the track.

To select a track from 1 to 9
For example: "6"
[6]

To select a two-digit track number 10 or higher
For example: "19"
[≥10/ENTER] → [1] → [9]

Push the buttons within 7 seconds of each other.

Play will begin from the selected track.

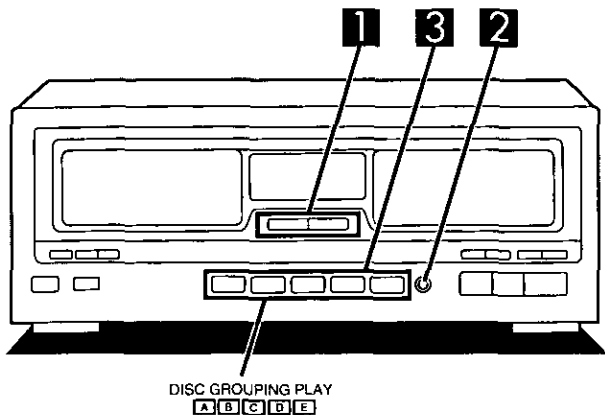

Disc grouping play

With disc grouping play, you can register discs into any of the five available groups (A-E) and then play only the discs in a specific group.

- The same disc can be registered in as many groups as you like.
- Each group can hold up to 60 discs.
- You can name each group.

To make groups

- 1 (In the stop mode)
Press [DISC SKIP (-) or (+)] to select the disc.

Note

- You cannot select slot No. 0.
- The changer skips over empty slots.

For your reference

You can also select a disc number by using the remote control. (→ page 24.)

- 2 Press [GROUP ENTER].

- 3 [Within 7 seconds]
Press the [DISC GROUPING PLAY] button you want.
(This inputs the disc in the group.)

For example: To input disc in group A.
Press [A].

- 4 Repeat steps 1, 2 and 3 until you have completed all items.

For your reference

The group contents will remain stored in memory even after the unit is switched off.

However, if the power cord is unplugged or the power supply is otherwise interrupted for an extended length of time, the contents will be erased from memory.

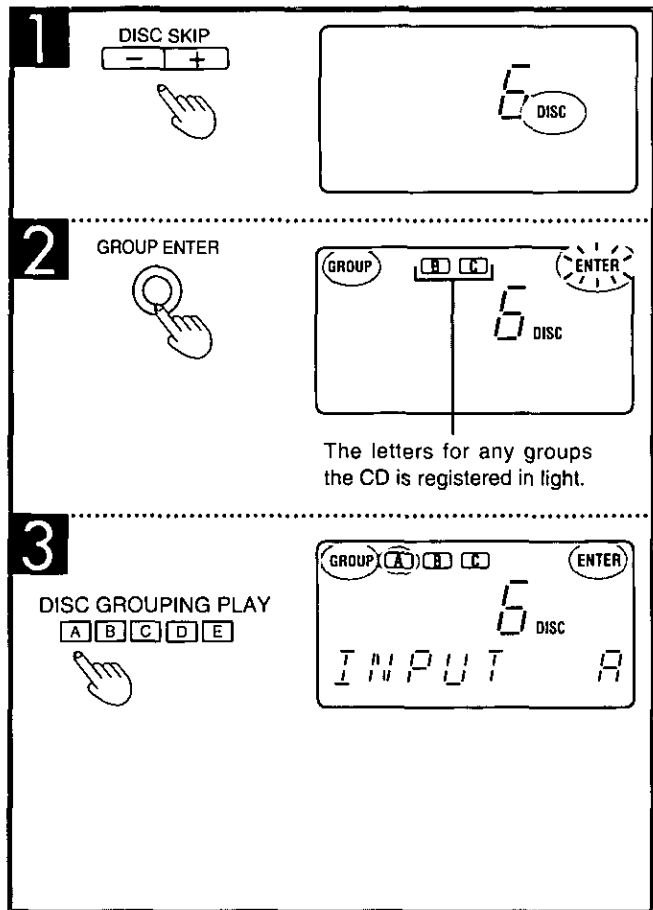

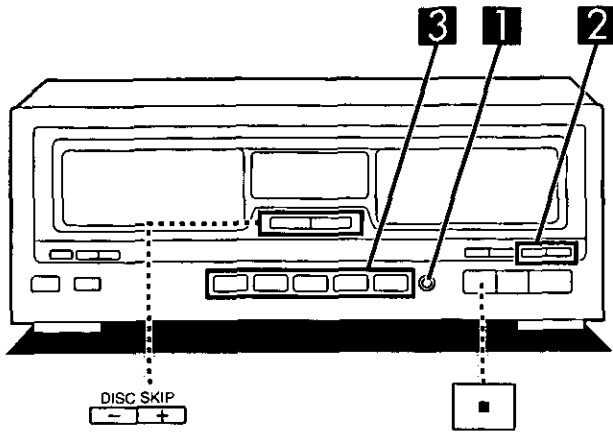

1 **GROUP ENTER**

GROUP [A] [B] [C] [ENTER]

5 DISC

If any groups have been registered already, their letters will light up.

2

GROUP [ENTER]

BALLADS

3

DISC GROUPING PLAY

GROUP [ENTER]

BALLADS

Listening to compact discs

To name groups

You can name your groups. The changer has several preset names to choose from.

- 1** [During sequential play or while stopped]
Press **[GROUP ENTER]**.
- 2** [Within 7 seconds]
Select the name you want with **[◀◀]** and **[▶▶]**.
Names change in rotation as shown below, every time you press **[◀◀]** or **[▶▶]**.

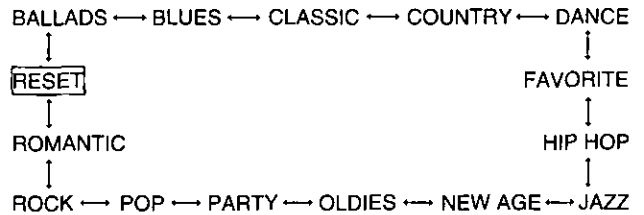

- 3** [Within 7 seconds]
Press the **[DISC GROUPING PLAY]** button for the group you want to name.
For example: To name group A
Press **[A]**.
- 4** Repeat steps 1, 2 and 3 to name other groups.

To cancel names

Select "RESET" in step 2 and then the name of the group you want to cancel in step 3. Thereafter, the group will appear as "GROUP ... (A,B,C,D or E)."

To check what discs are in what groups

[During sequential play or while stopped]

1. Press the **[DISC GROUPING PLAY]** button (A, B, C, D or E) you want and then press **[■]**.
2. Press either **[DISC SKIP (-) or (+)]**.
Every time you press **[DISC SKIP]**, the next disc number in order is displayed.

Note

After checking, if you press the button of a group that is lit on the display, the disc grouping mode disengages.

Listening to compact discs

To start play **A**

Unless otherwise specified, the changer selects sequential play.

[During sequential play or while stopped]

Press the [DISC GROUPING PLAY] button of the group you want.

For example: To hear group A

Press [A].

Note

- Unnamed groups will be displayed as "GROUP A, B, C ..." and so forth.
- If you press the group button of a group which has no discs registered in it, the message "NO INPUT" will appear on the display.

To cancel disc grouping play mode

[In the stop mode]

Press the [DISC GROUPING PLAY] button indicated on the display.

The group indication on the display will go out.

To cancel discs from groups **B**

1

[In the stop mode]

Press [DISC SKIP (-) or (+)] to select the disc.

2

Press [GROUP ENTER].

3

[Within 7 seconds]

Press the [DISC GROUPING PLAY] button you want.

For example: To cancel disc No. 6 from group A.

Press [A].

If the disc is registered in more than one group, you can cancel it from all groups in a single operation by pressing [■] in step 3 (in the stop mode).

A

DISC GROUPING PLAY
A B C D E

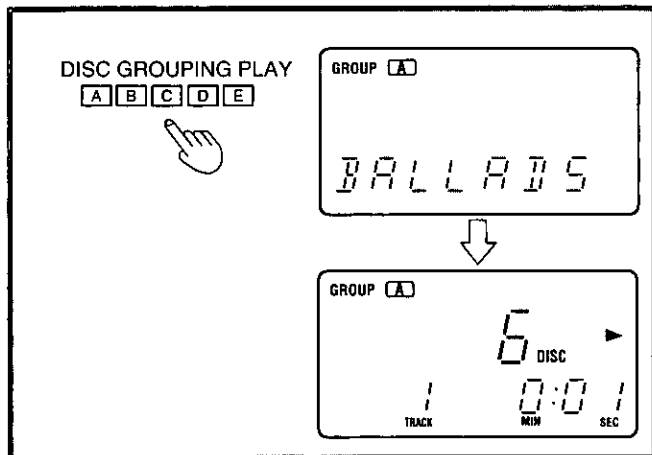
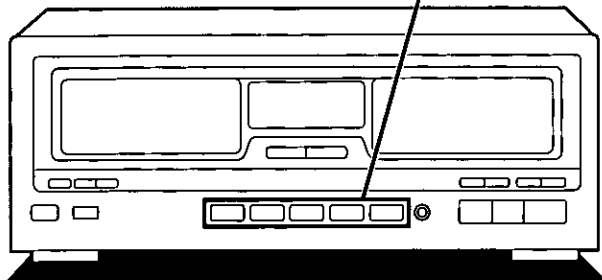

B

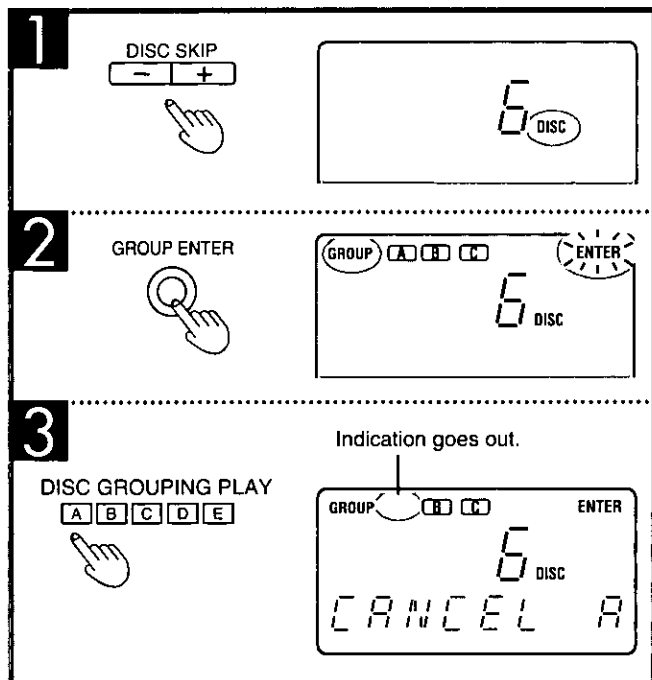
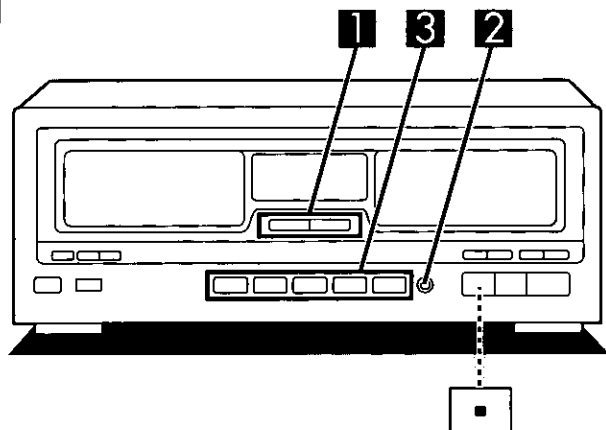

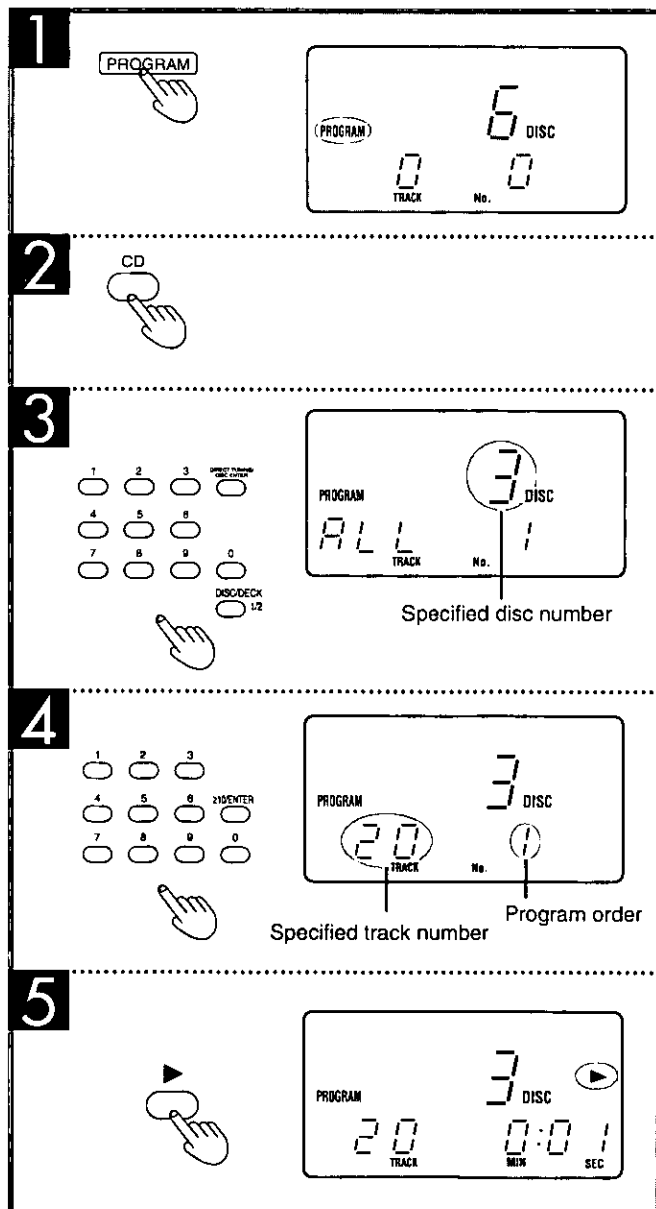
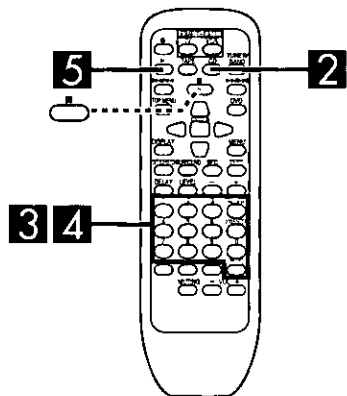
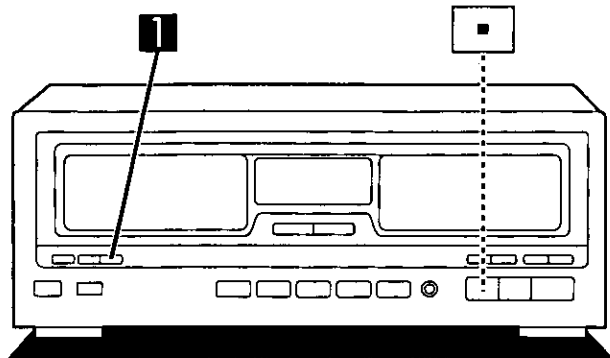

Listening to compact discs

Program play

Program play lets you playback your favorite tracks in the sequence you want to hear them. The program can hold up to 32 items.

- 1** [In the stop mode]
Press **[PROGRAM]**.
- 2** Press **[CD]**.
This will set the remote control to operate the CD changer.
- 3** Select the disc(s) with the numbered buttons.
To select disc 3.
DISC/DECK 1/2 → **3** → **DIRECT TUNING/DISC ENTER**

"ALL" indicates that the whole disc is selected. To program by disc, repeat the above. (The count increases by one for each operation.) You can select slot No.0.
- 4** Press the numbered button(s) to specify the track.
To select track No.20.
[≥10/ENTER] → **[2]** → **[0]**

To program tracks from the same disc, repeat this step.

Repeat steps 3 and 4 until you have completed all entries.

"PGM FULL" is displayed if you attempt to enter a 33rd selection.

If you enter non-existing disc(s) or track(s), the corresponding indicator illuminates and the entry is included in the count. During play, the changer will cancel the non-existing entry.

- 5** Press **[▶]** to start play.
To enter other selections during play, repeat steps 3 and 4.

To clear all programmed contents

[In the stop mode]

Press **[■]**.

To quit the program mode

[In the stop mode]

Press **[PROGRAM]**.

The changer will return to the sequential play mode.

If the mode is exited in this fashion, it is possible to re-enter the mode and listen to the same program after enjoying other modes of play. If discs are replaced, the new discs are included in the program. If a disc is removed or the new disc doesn't have the programmed track number, those entries are canceled as the program is played.

For your reference

The program is stored even if the unit is turned off or disconnected from its power supply. Extended disconnection will eventually result in erasure of the program.

Special note on recording programs

The changer needs time to change discs and find tracks. It will take the changer slightly longer than the total track time to record everything. How much longer depends on the program.

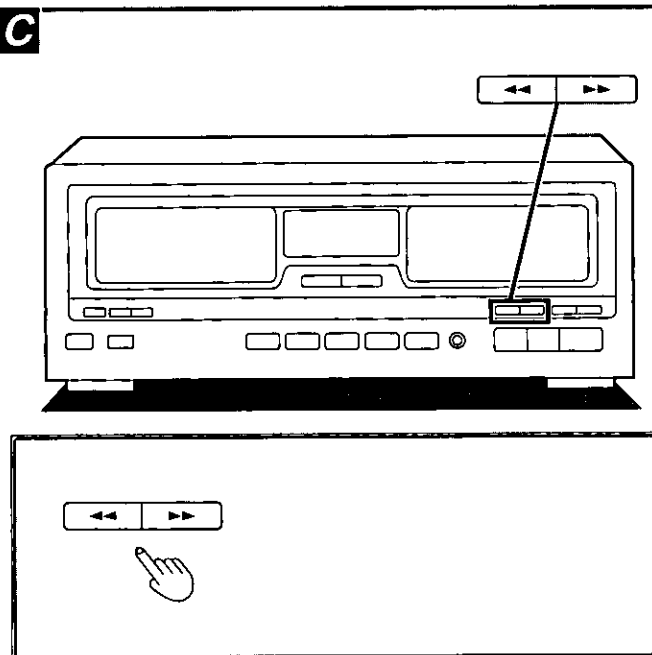
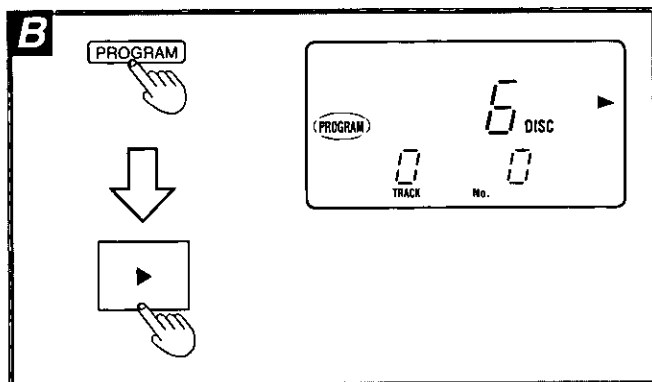
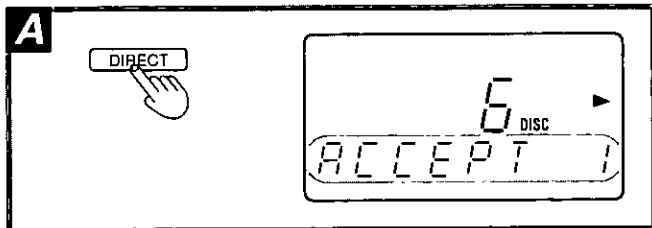
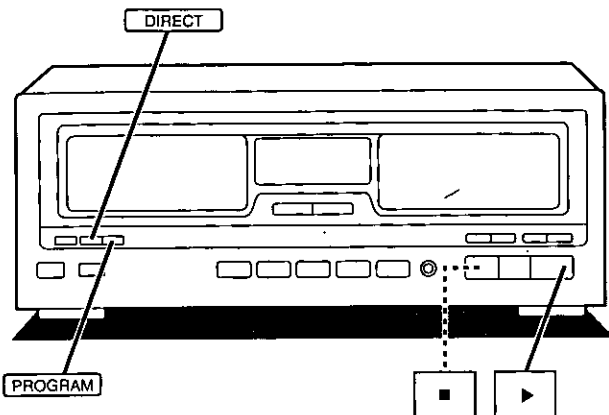

Direct programming

If, while listening to a certain track, you decide that you want to add that track to your program, you can with direct programming.

[While the track you want to program is playing]

Press [DIRECT].

The current track will be added to the end of the program. When you make a program as explained under "Program play", and then perform the above procedure without clearing the program first, the selected track is added to the end of the program.

Note

- You cannot add to the program if already full, that is, if 32 selections have already been programmed. If you press [DIRECT] in this case, the message "PGM FULL" will be displayed. Therefore, direct programming is possible only when 31 or less tracks have been programmed.
- During program play, the [DIRECT] button does not respond to touch.

To listen to programmed tracks

[In the stop mode]

Press [PROGRAM] and check "PROGRAM" appears on the display, then press [▶].

The program will start from the first track.

To clear all programmed contents.

[In the stop mode]

Press [■].

Search function

You can search rapidly forward or backward on the disc for specific sections.

[In the play or pause mode]

Press and hold [◀◀] or [▶▶].

◀◀: You can search backward.

▶▶: You can search forward.

Release the button when you reach the desired point. The changer will return to the previous mode (play or pause).

In the sequential/disc grouping play mode

When the changer finishes searching the current disc, it starts searching the next one.

In the single disc play mode

You can search forward or backward only within the current disc.

In the program play mode

You can search forward or backward only within the current track.

Listening to compact discs

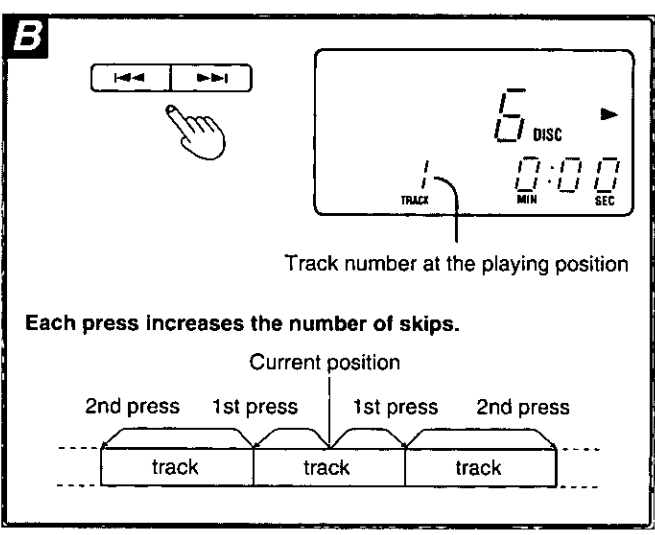
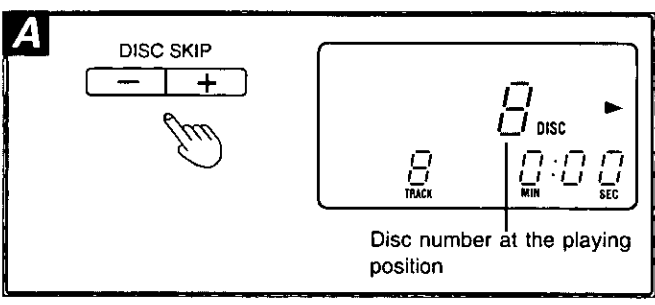
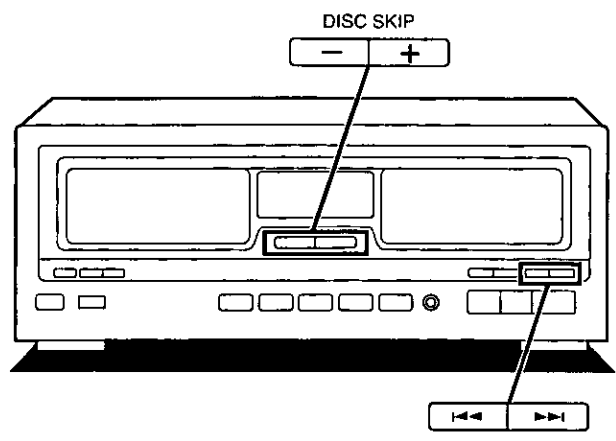

Skip function

To skip discs **A**

Use this function to skip discs to select a disc you wish to listen to.

You can use this function in stop, sequential play and disc grouping play modes.

Press [DISC SKIP (-) or (+)] until you reach the desired disc.

- : Skips to the preceding disc.
- +: Skips to the next disc.

Note

- The changer skips over empty slots.
- This function does not work during program play.
- If you attempt to use this function during single disc play, the changer will cancel single disc play.

To skip tracks **B**

Use this function to skip tracks to select a track you wish to listen to.

Press either [⏮] or [⏭] until you reach the desired track.

- ⏮: You can skip backward.
- ⏭: You can skip forward.

In the sequential/single disc/disc grouping/program play mode

In the program play mode, you can skip from one track to another in the programmed sequence.

In any other mode, you can skip forward and backward within the current disc only.

- ⏮: You can skip to the beginning of the track being played. If you press this button again quickly, you can skip to the beginning of the previous track.
- ⏭: You can skip as many tracks as the number of times you press the button.

You can also skip tracks when the changer is in the stop mode or pause mode.

Listening to cassette tapes

Types of tapes which can be played on this unit:

Normal position/TYPE I	✓
High position/TYPE II	✓
Metal position/TYPE IV	✓

The unit automatically identifies the type of tape.

The procedures described below are an example of playback on Deck 1.

1 Press [POWER] on the receiver and cassette deck.
First switch on the power of the receiver.

2 Press [A] to turn on SPEAKERS A.
If the button is pressed once more, the indicator will switch off and no sound will be heard from the speakers.

3 Turn [INPUT SELECTOR] to select "TAPE".

If you cannot select "TAPE", press [TAPE MONITOR] to cancel the tape monitor function.
If you are using a graphic equalizer, turn TAPE (MONITOR) on.

4 Press [▲ OPEN] on Deck 1, and then insert the cassette tape.
Close the cassette holder by hand.

To play back on Deck 2, press the button (4) for Deck 2.

5 Press [DOLBY NR] to listen to tapes recorded with Dolby B-type noise-reduction.
("Dolby noise-reduction system" → page 32.)

6 Press [REVERSE MODE] to select the appropriate reverse mode.

Each time the button is pressed, the indicator will change in the order:

↔ : One side only.

↻ : Both sides repeatedly (up to 8 times).

∞ : Both sides, once only.

("Reverse function" → page 32.)

7 Press [▶] (or [◀]).

Playback will begin.

▶: To begin from the forward side.

◀: To begin from the reverse side.

8 Adjust the volume.

(Continued on next page)

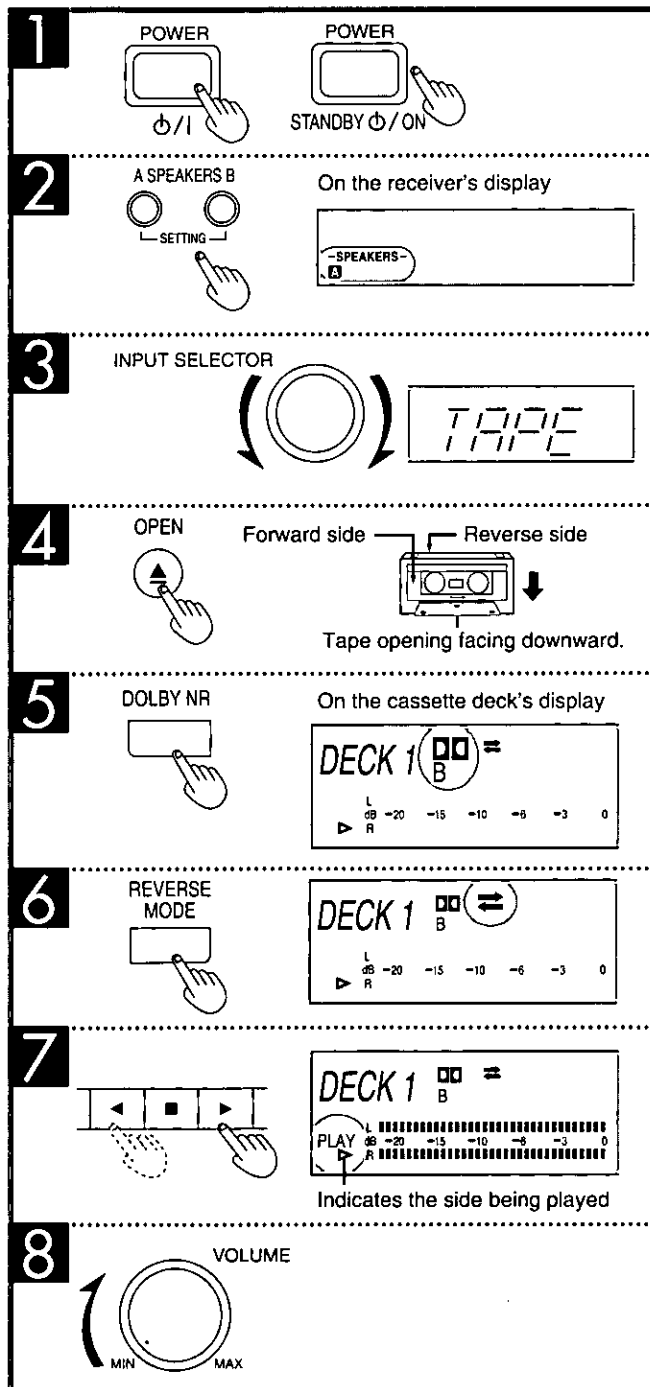
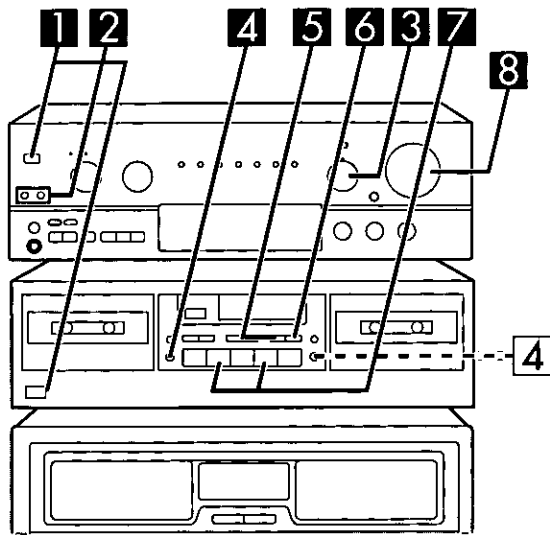

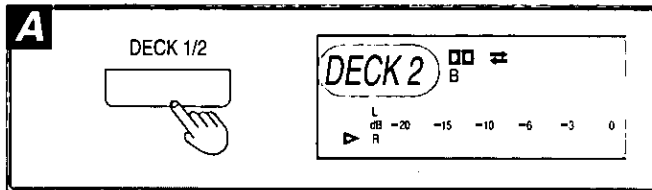
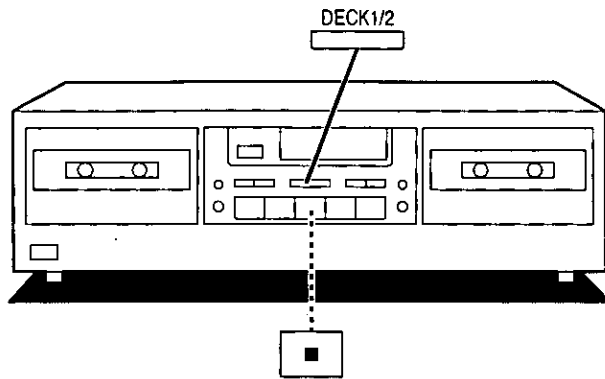

Listening to cassette tapes

To stop playback

Press [■].

After listening is finished

Be sure to reduce the volume level, and switch the power to the standby condition by pressing [POWER] of the receiver.

To change the Deck to be used

Press [DECK 1/2] to select the Deck you want to play.

Each time the button is pressed, the indicator will change:

DECK 1 \rightleftharpoons DECK 2

The indicator changes only if a tape is loaded in the both decks.

Reverse function

The reverse function on this unit has three modes (\rightleftharpoons , \rightleftarrows , ∞). Read the descriptions below and select the mode as desired.

Mode	Tape travel
\rightleftharpoons	Only one side of the tape (either the forward side or the reverse side) will be played, and operation will automatically stop when playback has been completed.
\rightleftarrows	Both sides of the tape will be played repeatedly eight times, and then operation will automatically stop. (If playback is begun from the reverse side, the forward side will be played seven times.)
∞	When there is a tape in only one of the decks Both sides of the tape will be played once, and then operation will automatically stop. (If playback is begun from the reverse side, the forward side will not be played.) When there is a tape in each of the decks The forward and reverse sides of the tape in Deck 1 will be played, followed by the forward and reverse sides of the tape in Deck 2, and after this operation is repeated eight times, operation will automatically stop. (If playback is begun from Deck 2, the tape in Deck 1 will be played seven times.)

Dolby noise-reduction system

The Dolby noise-reduction system is designed to effectively reduce the annoying high-frequency "hissing" noise which typical of cassette tapes. During recording, the system functions to increase the high-frequency sound level, and then, during playback, that same portion is weakened to bring it back to the previous level. This unit is equipped with the Dolby B NR-type.

Dolby B-type noise-reduction

Noise is reduced to about one-third.

Use this system when playing back tapes recorded by the Dolby-B noise-reduction system, such as prerecorded music tapes, etc.

Dolby noise reduction manufactured under license from Dolby Laboratories Licensing Corporation.

"DOLBY" and the double-D symbol  are trademarks of Dolby Laboratories Licensing Corporation.

Listening to cassette tapes

Series playback

Both sides of the tape in Deck 1 will be played, followed by both sides of the tape in Deck 2. (Repeated up to eight times.)

Preparation

Load the tapes to be played into Deck 1 and Deck 2. Note that for series playback it is not possible to select different types of Dolby NR for Deck 1 and Deck 2. It is recommended that you use two tapes which were recorded using the same type of Dolby NR (or both recorded without Dolby NR).

- 1** Press [DOLBY NR] to listen to tapes recorded by Dolby B-type noise-reduction.
- 2** Press [REVERSE MODE] to select the "∞" mode.
- 3** Press [DECK 1/2] to select Deck 1.
- 4** Press [▶].
Series playback will begin from the forward side of the tape in Deck 1.

To stop playback

Press [■].

For your reference:

It is also possible to begin series playback from the reverse side of the tape in Deck 1 or from Deck 2. ("Reverse function" → page 32.)

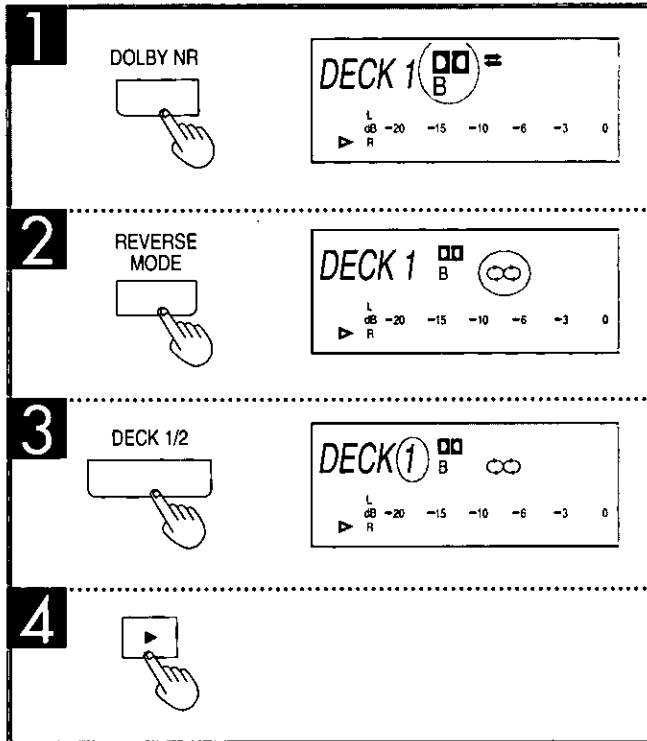
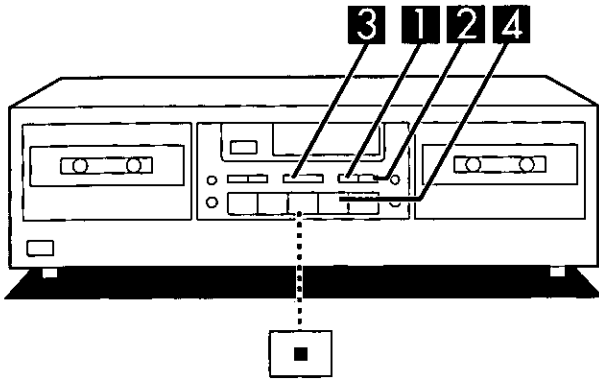

A

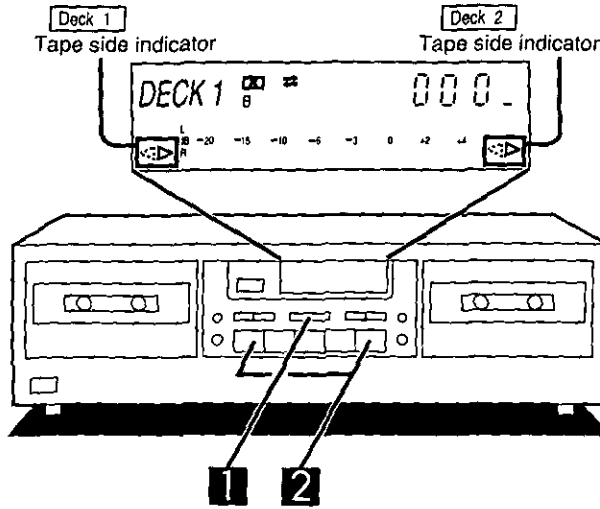

1 DECK 1/2

2

Tape side indicator	Rewind	Fast forward

B

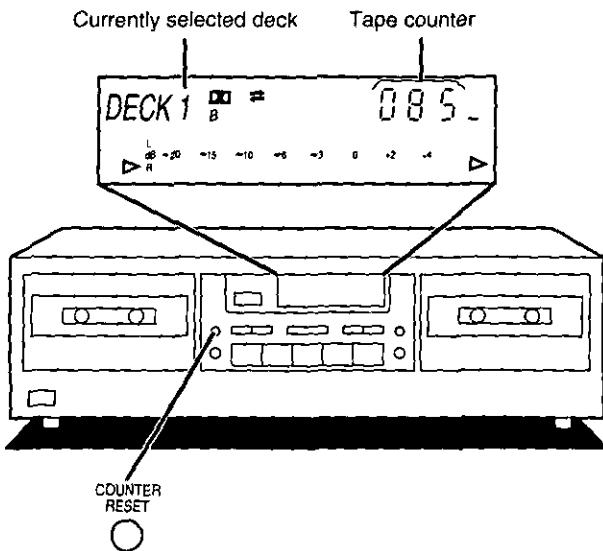

Listening to cassette tapes

To fast-forward or rewind the tape **A**

- 1** Press [DECK 1/2] to select the Deck (1 or 2).
- 2** Press [<<] or [>>].

Because this unit is capable of playing back both sides of the tape, the operation changes in accordance with the direction of the tape side indicator.

The tapes in Deck 1 and Deck 2 can be advanced or rewound at the same time.

Tape counter **B**

The tape counter indicates the amount of tape travel as a numerical value based on the number of revolutions of the tape hub. As you switch between Deck 1 and Deck 2, the tape counter shown on the display changes too.

To reset the tape counter

Press [COUNTER RESET].
 The tape counter of the currently selected deck will revert back to "000", while that of the other deck will remain unchanged.

For your reference:
 When the tape is traveling in the reverse direction, the value displayed on the tape counter will count down. After "000" is reached, the display will switch to "999" and will then continue counting down.

Other functions

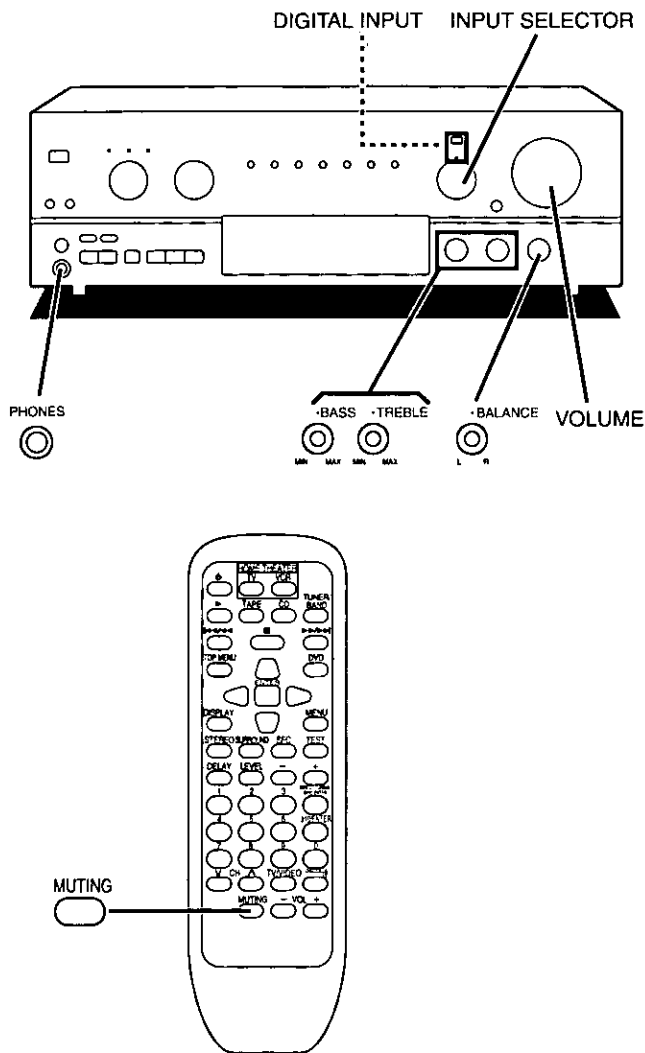

To adjust the tone quality **A**

Turn [BASS] to adjust the low frequency sound.
Turn [TREBLE] to adjust the high frequency sound.

To adjust the sound balance **B**

Turn [BALANCE] to adjust the left/right sound balance.

To mute the sound level **C**

by remote control only

Press [MUTING].

The message "MUTING ON NOW" runs repeatedly from right to left across the display as long as the muting function is on.
Press once again to return to the previous volume level.

Note

Muting is cancelled when the receiver is turned off.

To enjoy external sources **D**

Turn [INPUT SELECTOR] to select and start the desired source.

(Refer to the appropriate operating instructions for details.)

The indicator corresponding the select source lights and the source is shown on the display.

VCR : To watch video tapes

TV : To watch TV

DVD : To watch DVD

PHONO: To listen to phono discs

Note

To watch a video (or DVD) or the TV, set the TV to either, the TV mode or VIDEO mode.

If you are using VCR and you select TAPE, CD, TUNER, or PHONO

The picture will remain on the screen.

Press [DIGITAL INPUT] to select "DIGITAL" if you have used digital connection for TV, DVD, or CD.

The DIGITAL INPUT indicator lights.

Only Dolby Digital, DTS or PCM signals (44.1 kHz or 48 kHz) can be reproduced through the digital terminal:

The digital input signal of sampling frequencies 96 kHz and other signal formats such as MPEG cannot be reproduced on the receiver.

To listen through headphones **E**

- ① Reduce the volume.
- ② Connect the headphones.
Plug type: 6.3 mm (1/4 in.) stereo
- ③ Adjust the volume.

Select STEREO or turn SPEAKERS A and B off when using headphones. Turning the speakers off automatically engages STEREO mode and ensures no sound is heard from the subwoofer.
If SURROUND is used, the sound heard through the headphones will seem unusual.

Note

Avoid listening for prolonged periods of time to prevent hearing damage.

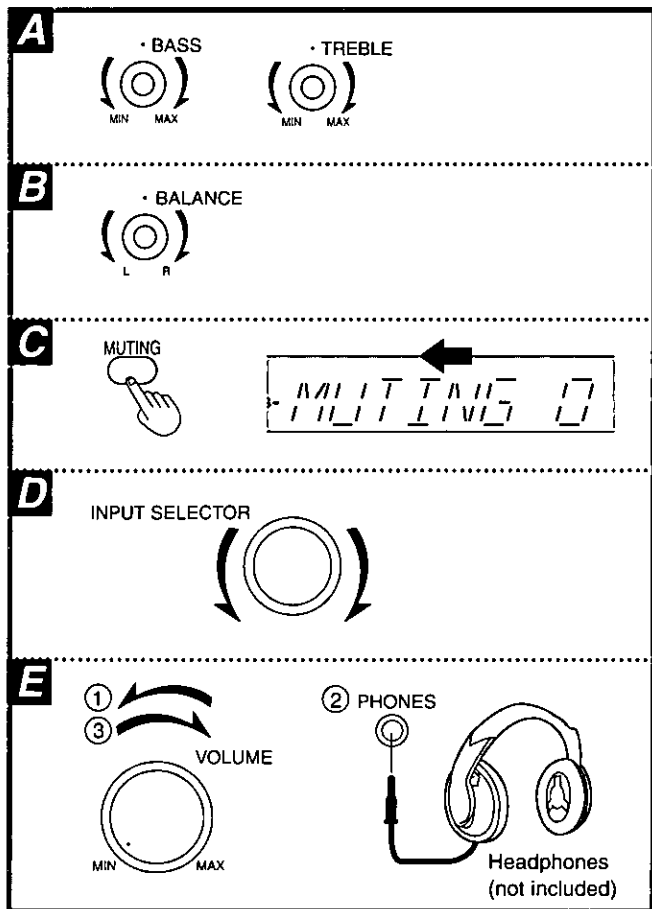

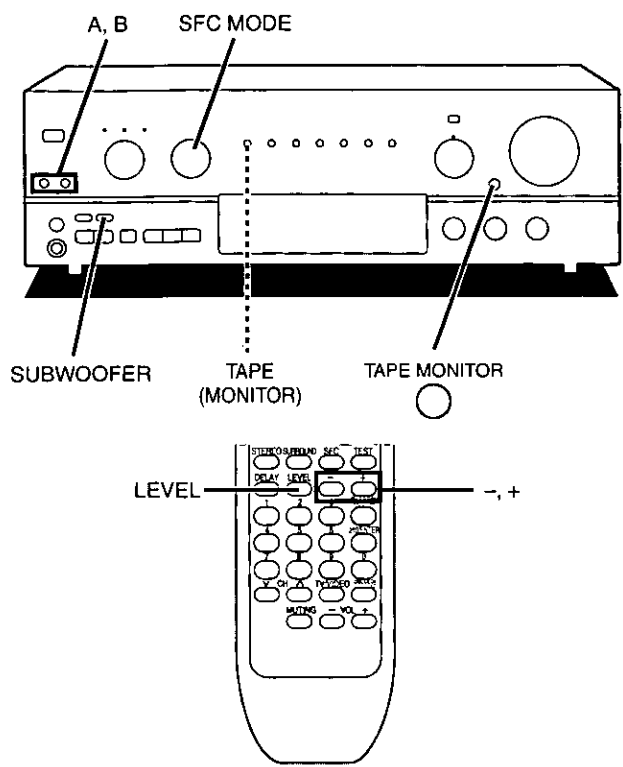

A TAPE MONITOR

B

① A SPEAKERS B
SETTING

② A SPEAKERS B
G

③ SFC MODE

④ A SPEAKERS B
SETTING

C SUBWOOFER

Other functions

The TAPE (MONITOR) indicator **A**

This indicator lights in the following two situations:

1. While TAPE is selected.
2. While TAPE MONITOR is in use.

To use the tape monitor

The tape monitor can be used to check the recorded sound when connecting a 3 head tape deck (not included) or using graphic equalizer connected to the TAPE terminals.

If [TAPE MONITOR] is pressed while a source other than TAPE is selected, the "TAPE (MONITOR)" indicator lights and the tape monitor comes on.

Press [TAPE MONITOR] again to turn the tape monitor off.

Leave the tape monitor off when using the tape deck included with this system.

Note

- The tape monitor cannot be used when TV, DVD, or CD digital input is being used.
- If you are using the tape monitor and you select a digital input source, the tape monitor switches off.
- Depending on the setting on the graphic equalizer, there may be some distortion (→ page 8).

Dynamic range compression **B**

"Dynamic range compression" (DR COMP) is a function for compressing the dynamic range (reproduction level range) of audio signals. It is used for viewing movie software late at night or at other times when high volume levels are not desirable.

This function only works with DR COMP compatible Dolby Digital format software.

The factory setting is "OFF".

① Press [A] and [B] at the same time.

"SETTING" appears on the display.

② Press [A] to select "DR COMP".

Each time the button is pressed the display switches as follows.

SIZE → DISTANCE → FILTER → DR COMP

③ Turn [SFC MODE] to select the setting.

Each time the selector is turned the display switches as follows.

OFF → STANDARD → MAX

The factory setting is OFF.

④ Press [A] and [B].

"COMPLETE" appears on the display.

For your reference

When DR COMP is on, scenes that already have a low sound level will be heard as they are. When scenes that are loud occur, the function acts to reduce the peak level.

The sound field will remain intact even if DR COMP is functioning.

Using a subwoofer **C**

Turn subwoofer output on if you connect a subwoofer (→ page 12.)

Press [SUBWOOFER] to select "ON".

Turn the subwoofer off when using STEREO or reduce its volume.

To adjust subwoofer volume

- ① Press [LEVEL].
- ② Press [+] or [-].

The level can be adjusted between -10 and +10, with the current level of the front speakers being zero.

Making a recording

Note

You cannot record a source connected through the receiver's digital terminals.

Recording from the radio or external source (Deck 2 only)

Types of tapes which can be used for recording:

Normal position/TYPE I	✓
High position/TYPE II	✓
Metal position/TYPE IV	✓

Preparation

Wind the tape past the leader tape section so that recording can begin straight away.

1 Turn on the power of the systems.

2 Press [**▲ OPEN**] on Deck 2, and then insert the cassette tape.
Close the cassette holder by hand.

3 Press [**DOLBY NR**] to record with Dolby B-type noise-reduction system.

When recording a tape without using a Dolby NR system, press so that the indicators go off.

4 Press [**REVERSE MODE**] to select the desired reverse mode.

Each time the button is pressed, the indicator will change in the order:

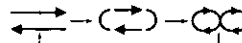

→ : Only one side will be recorded, and then operation will automatically stop.

↔, ∞ : Both sides (the forward side first, and then the reverse side) will be recorded, and then operation will automatically stop.

5 Press [**● REC PAUSE**].

The unit will be in the recording standby mode.

6 Turn [**INPUT SELECTOR**] to select the source to be recorded.

Any source can be selected except TAPE.
When recording CD, DVD, or TV, ensure the source is connected through the corresponding analog terminals (⇒ page 8–9) and "ANALOG" input is selected (⇒ page 22).

7 Press [**▶**] (or [**◀**]) to begin recording, and play the source to be recorded.

▶ : To begin recording from the forward side.

◀ : To begin recording from the reverse side.

Note

When recording on both sides of the tape, be sure to press [**▶**].

To stop recording

Press [**■**].

To temporarily stop recording

Press [**● REC PAUSE**].

To resume recording

Press either [**◀**] or [**▶**], corresponding to the side of the tape side indicator ("◀" or "▶") which is lit.

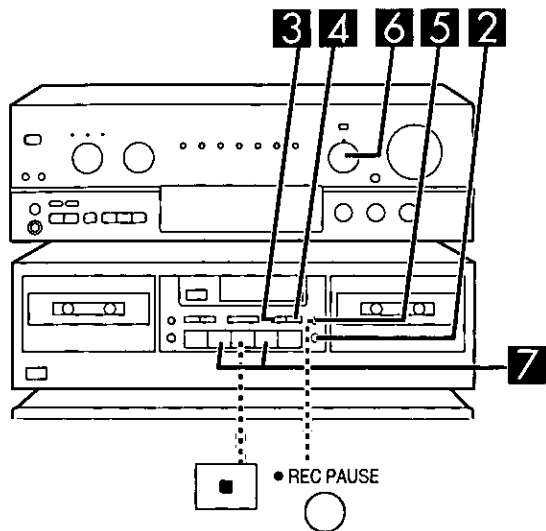

2 OPEN

Forward side → Reverse side

3 DOLBY NR

On the cassette deck's display.

4 REVERSE MODE

5 ● REC PAUSE

6 INPUT SELECTOR

7

Making a recording

Tape-to-tape recording

Use Deck 2 to record the sound being played back on Deck 1.

Preparation

Load tapes which have been advanced to the end of the leader tape into both decks.

Deck 1: For playback Deck 2: For recording

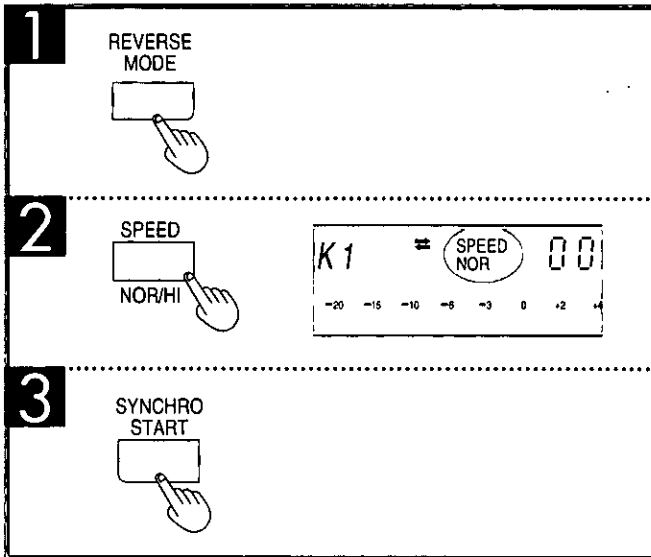
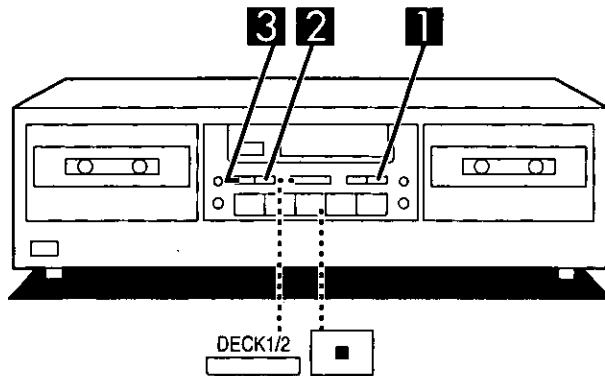

1 Press [REVERSE MODE] to select the desired reverse mode.

Each time the button is pressed, the indicator will change in the order:



→ : Only one side of the tape will be recorded, and then operation will automatically stop.

⇌ : Both sides of the tape (first the forward side and then the reverse side) will be recorded, and then operation will automatically stop.

If the recording tape is longer than the playback tape, the playback tape will be played repeatedly as many as eight times until the recording tape is finished.

∞ : Both sides of the tape (first the forward side and then the reverse side) will be recorded once, and then operation will automatically stop.

Note

To record on only one side of the tape, set the tape side indicators ("◀" or "▷") on Deck 1 and Deck 2 in accordance with the tape sides to be played back and recorded.

To record on both sides of the tape, set the tape side indicators on both Deck 1 and Deck 2 to the forward side (▷).

2 Press [SPEED] to select the recording speed.

Each time the button is pressed, the indicators will change in the order: NOR → HI → (off).

NOR: normal speed

HI: approx. double speed

3 Press [SYNCHRO START].

Recording will begin.

To stop recording

1. Press [DECK 1/2] to select Deck 2.
2. Press [■].

Note

In order to avoid operation errors later, be sure to switch off the [SPEED] button (the "NOR" and "HI" indicator will go out) after the tape-to-tape recording has finished.

For your reference:

- The Dolby effects will be recorded as they are on the tape being played back.
- Because the signal being recorded from Deck 1 onto Deck 2 does not pass through the amplifier, it is possible to change the setting of the amplifier's input selector during recording in order to listen to some other sound source.

Note

- When recording with the recording speed set to hi-speed, noise interference may be recorded onto the tape if there is a television set nearby, so make the recording in a location separated from the television set or switch off the television set during recording.
- Noise reduction does not work during playback of tape-to-tape recordings. If the tape was recorded with noise reduction, listen at low treble. Lower the treble with the receiver's treble control before playback.

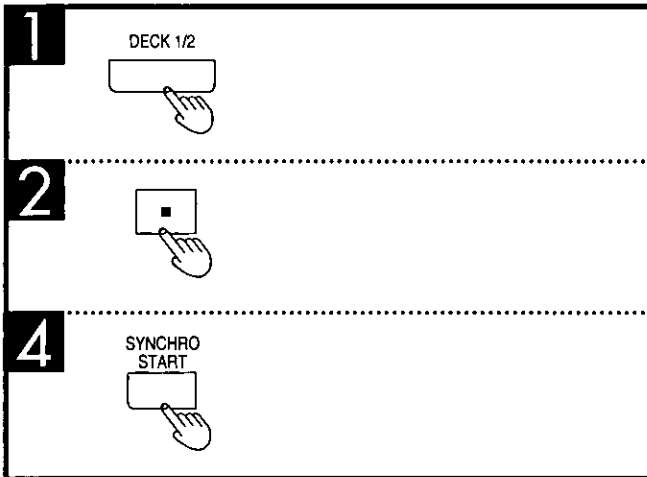
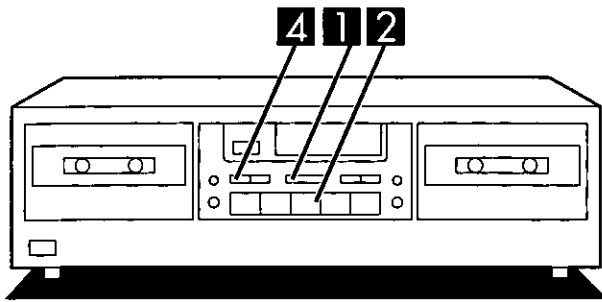
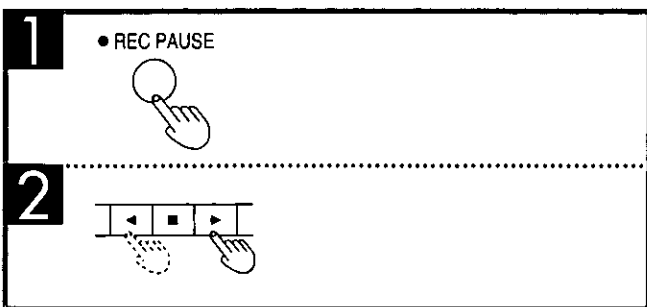
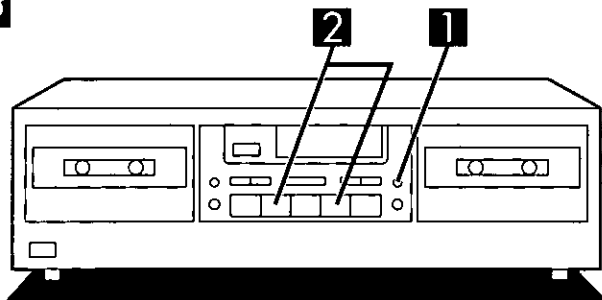
A**B****Making a recording****To record selected tracks **A****

- 1** [During recording]
Press [DECK 1/2] to select Deck 1.
- 2** Press [■].
Deck 1 will stop, and Deck 2 will record a 4-second silent interval and then enter the recording standby mode.
- 3** Operate Deck 1 to find the track you wish to record.
It is also possible to change the playback tape at this time.
- 4** Press [SYNCHRO START].
Recording will resume.

To cut unwanted parts during recording **B**

- 1** Press [● REC PAUSE] during recording.
Deck 2, which was recording, will enter the pause mode, and Deck 1 will continue playback.
(If you were recording at hi-speed, Deck 1 will change to normal speed while Deck 2 is on pause, but will return to hi-speed when you resume recording.)
- 2** [When Deck 1 reaches a part you wish to record]
Press either [◀] or [▶], corresponding to the tape side indicator which is lit.
Deck 2 will resume recording.

To make blank tapes (Deck 2 only)

1. Switch the amplifier to an input source which is not being used.
2. Insert the recorded tape into DECK 2.
3. Press [DOLBY NR] so that the Dolby NR indicator is off.
4. Press [REVERSE MODE] to select reverse mode.
5. Press [● REC PAUSE].
6. Press [◀] or [▶], whichever side you want to erase.

Note

To erase both sides of the tape, be sure to press [▶].

To record on a VCR

You can record audio and video sources on a VCR when it is connected to the "VCR" terminals on the receiver.

1. Switch the receiver to the input source that you want to record.

Note

- Recording from the tape deck is not possible.
2. Begin recording on the VCR and start the desired source.
(Refer to the appropriate operating instructions for details.)

Digital Signal Processor (DSP)

You can take advantage of the following modes with this unit. The DSP modes can be set for each source. Once you have set the mode for a source, the mode is engaged whenever that source is selected.

These modes are automatically switched to STEREO if SPEAKERS B is selected or both speakers are turned off. When SPEAKERS B is turned off or SPEAKERS A is selected, the mode is switched back to the latest mode.

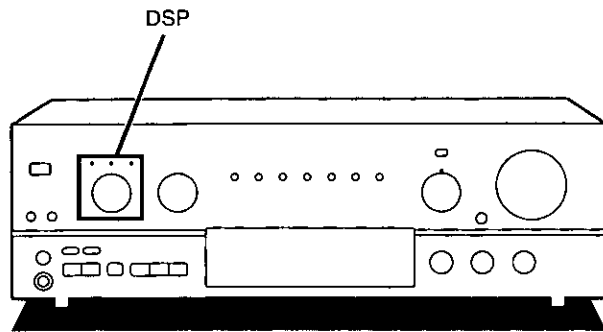

STEREO mode **A**

Use this mode when you want to listen to stereo sources, whether they are digital or analog, or when you want to playback Dolby Digital or DTS sources through two channels. The sounds usually fed through the other speakers are down-mixed so they are output through the left and right front speakers. There may be surround change in the overall sound when surround sources are down mixed.

Turn [DSP] to select "STEREO".

SURROUND mode **B**

By selecting this mode while digital input is being used, the unit automatically determines the kind of digital source being used (Dolby Digital, Dolby Surround, or DTS), and processes it accordingly. Select this mode also when you are playing back an analog source, VCR for example, that has been recorded in Dolby surround.

Turn [DSP] to select "SURROUND".

The following indicators light depending on the source.

PRO LOGIC

When playing analog sources.

When playing digital sources with PCM signals.

When playing Dolby Digital sources that contain Dolby Pro Logic.

DIGITAL

When playing Dolby Digital sources.

dts

When playing DTS sources.

If the beginning of a track is cut off when playing CDs

The beginning of a track may not be heard if you play CDs in STEREO mode.

You can solve this by engaging the PCM FIX mode.

Press and hold [DIGITAL INPUT] for four seconds.

"PCM FIX" appears on the display.

This mode can be selected for each source, but is cancelled when the unit is turned off.

Note

- The PCM FIX mode can be selected in STEREO mode only.
- Dolby Digital and DTS source cannot be played while PCM FIX mode is on.
- Noise can occur if DTS sources are played while PCM FIX mode is engaged. To avoid this, be sure to turn PCM FIX mode off after use.

Manufactured under license from Dolby Laboratories. "Dolby", "Pro Logic" and the double-D symbol are trademarks of Dolby Laboratories. Confidential Unpublished Works. © 1992-1997 Dolby Laboratories, Inc. All right reserved.

Manufactured under license from Digital Theater Systems, Inc. US Pat. No. 5,451,942 and other world-wide patents issues and pending. "DTS" and "DTS Digital Surround" are trademarks of Digital Theater Systems, Inc. © 1996 Digital Theater Systems, Inc. All right reserved.

A

B

Dolby Pro Logic

Dolby Digital

DTS

Software with the following mark can be played back in these modes.

DIGITAL
dts
SURROUND

Adjusting speaker output level

Adjust speaker level so the output from all the speakers is the same apparent level when sitting where you would normally enjoy a source.

1 Turn [DSP] to select "SURROUND".

2 Press [A] to turn on SPEAKERS A.
You cannot adjust SPEAKERS B.

3 **by remote control only**

Press [TEST] to output the test signal.

"TEST" appears on the display.

The signal is output from each speaker in order for about two second each.

- L: Front speaker (Left)
- C: Center speaker
- R: Front speaker (Right)
- RS: Surround speaker (Right)
- LS: Surround speaker (Left)
- SW: Subwoofer

Speakers set as "NONE" or "OFF" are skipped.

Note

DSP switches to SURROUND mode when the test starts.

4 **by remote control**

Press [VOL (-) or (+)] to set the volume level normally used for enjoying the source.

Note

Use [BALANCE] if the left right balance of the front speakers is off.

5 **by remote control only**

Press [LEVEL] to select speaker channel to adjust.

The current channel appears on the display.

Press again to change the speaker channel.

Speaker set as "NONE" or "OFF" are skipped.

6 **by remote control only**

Press [-] or [+] to adjust the level to the same apparent level as the front speakers.

The four channels can be adjusted between -10 dB and +10 dB, with zero being the current level of the front speakers.

7 Repeat 5 and 6 for each speaker channel.

To stop the test signal

Press [TEST].

Note

The test signal will not be output if DSP DEFEAT is engaged. Ensure DSP is ON (→ page 42).

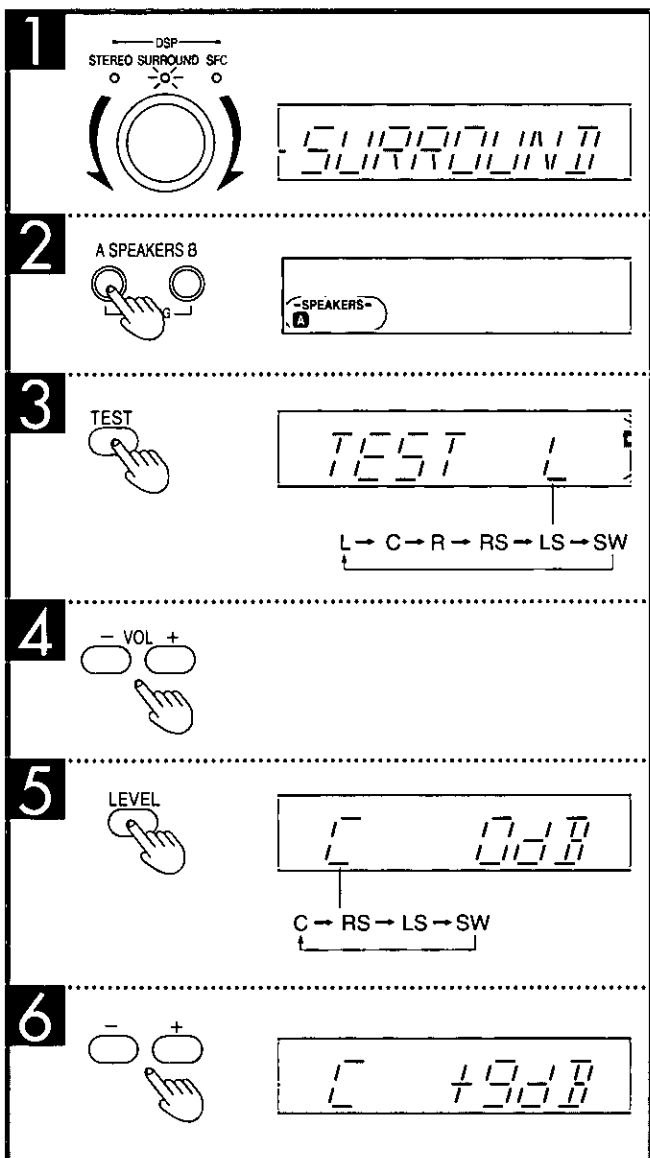
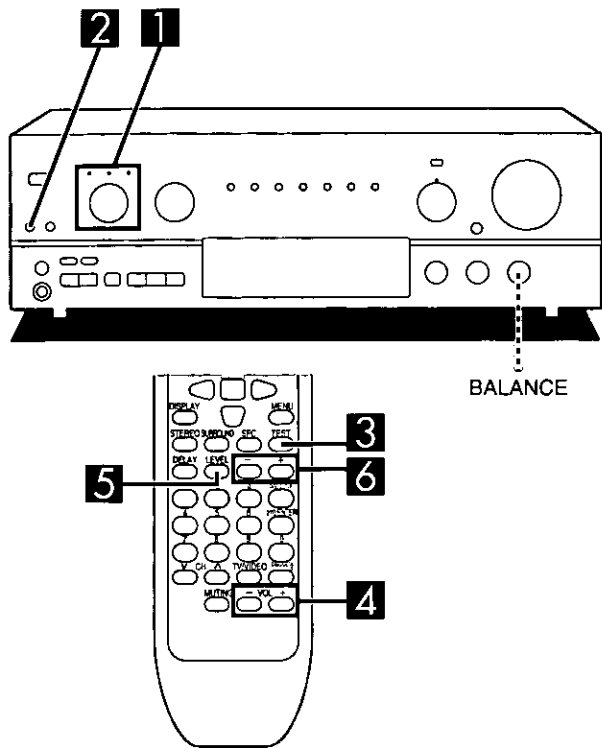

Digital Signal Processor (DSP)

SFC mode

The SFC (Sound Field Control) function gives presence and spread thereby enhancing and enriching the music or movies. Read the following explanations better understand how to make your selection.

Note

SFC is designed to add surround-like effects to stereo sources. Select the appropriate mode when playing back Dolby Digital, DTS, or Dolby Surround sources.

HALL

This mode imparts a reflection and spread which will make you feel as if you are in a large concert hall.

CLUB

Like jazz club, this mode provides an exciting and intimate atmosphere. It simulates the sound field of a relatively small room having a low ceiling and hard reflective surfaces, for a "live" sound with enhanced presence to bring the performers up close.

LIVE

Primarily for vocal pieces, this mode adds gloss to the vocals and you'll feel as though you were hearing a live stage performance.

THEATER

You can clearly perceive the directions and source of the movie. Real ambience of sound can also be recreated naturally using this mode.

SIM Surr (SIMULATED)

Choose this mode if little or no sound will be heard from the surround speakers.

You can feel as if you were in a more expanded space adding to the actual sound from the source.

This mode also adds effect to monaural sources by outputting sound from surround speakers.

1 Turn [DSP] to select "SFC".

2 Turn [SFC MODE] to select the desired SFC mode.

Note

Dolby Digital and DTS sources cannot be played with SFC modes.

If reception is weak or "TUNED" fails to light completely while playing the radio

Press and hold [-DSP ON/DEFEAT] until "DEFEAT" appears on the display.

Press and hold again to turn DSP on. The STEREO mode is selected.

This allows you to play back sound without it passing through the digital signal processor (DPS). When this is selected, no sound will go through the center or surround speakers or the subwoofer.

Note

When "DEFEAT" is selected the sound mode indicators (STEREO, SURROUND and SFC) go out and these modes can not be selected.

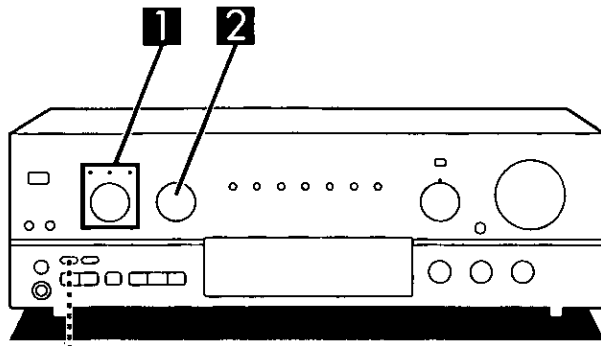

-DSP ON/DEFEAT

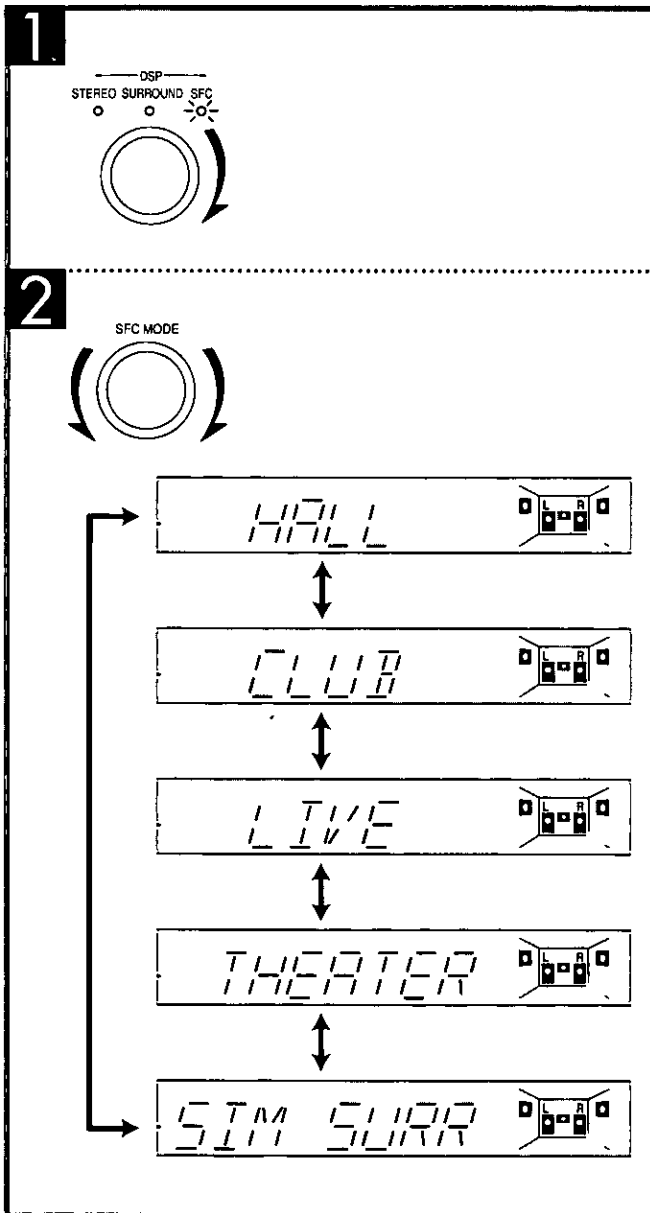

Adjusting field of sound

To adjust speaker level **A**

by remote control only

1 Press [LEVEL] to select the speaker channel to adjust.

Each time the button is subsequently pressed, the speaker whose level is to be set is selected in the listened sequence. Speakers set for which "NONE" or "OFF" has been set are skipped.

2 Press [-] or [+] to adjust the output level.

Channels C, RS, LS, and SW can be adjusted between -10 dB and +10 dB.

To adjust delay time **B**

You can adjust only surround channel only in SFC mode.

by remote control only

1 Press [DELAY].

When the button is pressed, the current delay time is displayed.

2 Press [-] or [+] to set the time.

Select a delay time to suit your individual needs. Delay time can be set at 10 milliseconds (ms) intervals between 10 and 100 ms.

The factory setting for each mode is 50 ms.

For your reference

Settings for volume level and delay time can be done for each SFC mode.

A

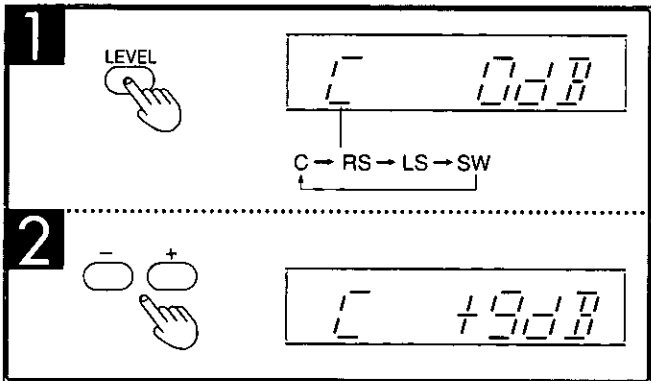
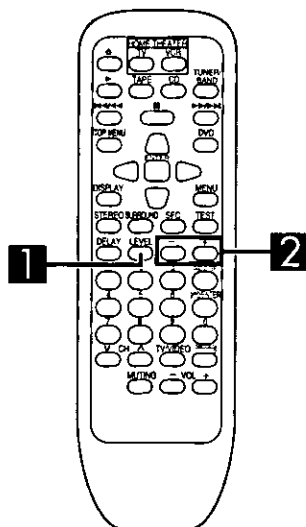

B

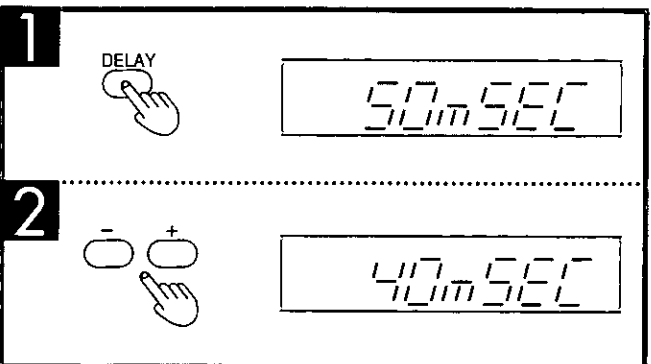
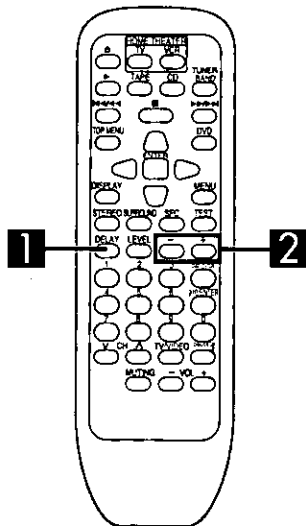

Using the remote control

This remote control can be used to operate the receiver you purchased and some other Panasonic and Technics cassette decks, CD players, TVs, VCRs, and DVD players, provided they are equipped with a remote control sensor.

It is also possible to change-over the remote control code so that the remote control can operate TVs and VCRs which have not been manufactured by this company. (➔ page 50)

To operate the receiver

Point the remote control toward the receiver

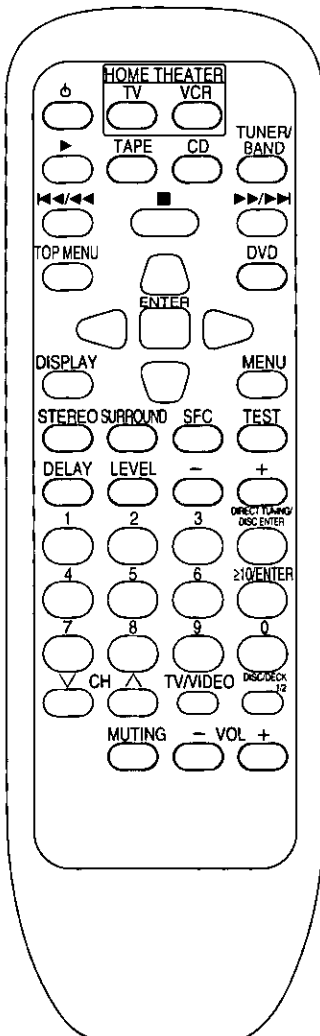



Remote control operation

<p>To turn the receiver ON/OFF</p>	<p>TUNER/BAND ➔ </p>
<p>To select an input source and switch the remote control to each operation mode</p>	<p>TAPE VCR TV DVD CD TUNER/BAND</p> <p>Note</p> <ul style="list-style-type: none"> • PHONO can not be selected with this remote control. • TAPE MONITOR cannot be controlled with the [TAPE] button.
<p>To turn on the STEREO mode</p>	<p>STEREO </p>
<p>To turn on the SURROUND mode</p>	<p>SURROUND </p>
<p>To turn SFC on and select the desired mode</p>	<p>SFC </p> <p>Changes as follows each time the button is pressed.</p> <p>HALL -- CLUB -- LIVE -- THEATER</p> <p>└ SIM SURR (SIMULATED) ┘</p>
<p>To output a test signal</p>	<p>TEST </p> <p>Press once more to stop the signal.</p>
<p>To select the speaker channel and adjust its output level</p>	<p>LEVEL ➔ </p> <p>When the SURROUND or SFC modes are on You can adjust the level of the center and surround speakers and the subwoofer.</p> <p>When the STEREO mode is on You can adjust the level of the subwoofer.</p>
<p>To change the surround channel delay time</p>	<p>When the SFC mode is on</p> <p>DELAY ➔ </p>
<p>To mute the sound level</p>	<p>MUTING </p> <p>The message "MUTING ON NOW" runs repeatedly from right to left across the display as long as the muting function is on. Press once more to return to the original volume.</p>
<p>To adjust the volume level</p>	<p> VOL </p>

To operate the receiver (continued)

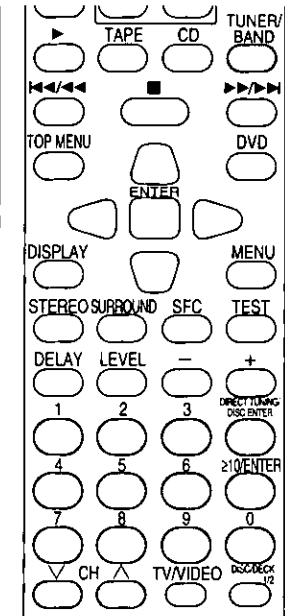

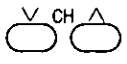
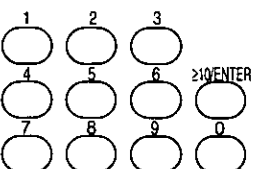
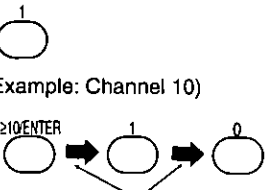
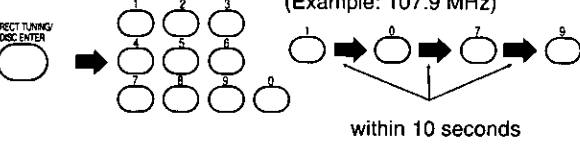

Make sure the remote control is in the tuner operation mode. (⇒ Page 44.)

<p>Point the remote control toward the receiver</p>  	<h3>To listen to radio broadcasts</h3>	
	<p>To select "FM" or "AM"</p>	<p>TUNER/BAND</p>  <p>Changes as follows each time the button is pressed. FM ⇌ AM</p>
	<p>To select the desired channel sequentially (Preset tuning)</p>	<p>CH</p> 
	<p>To select the desired channel directly (Preset tuning)</p>	<p>(Example: Channel 1)</p>  <p>(Example: Channel 10)</p>  <p>within 10 seconds</p>
<p>To select radio stations by frequency (Direct tuning)</p>	<p>(Example: 107.9 MHz)</p>  <p>within 10 seconds</p>	

To operate the cassette deck

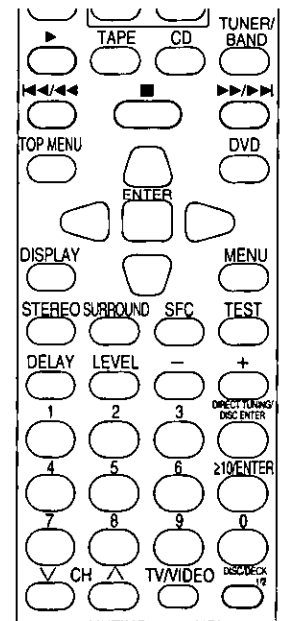
Turn the cassette deck ON before trying to operate it by remote control.

Make sure the remote control is in the cassette deck operation mode. (⇒ Page 44.)

<p>Point the remote control toward the cassette deck</p>  	<p>To select the tape deck (DECK 1/DECK 2)</p>	
	<p>DISC DECK 1/2</p> 	
	<p>To start playback</p>	
	<p>To fast-forward or rewind the tape</p>	<p>While the tape is stopped</p> 
<p>To stop playback</p>		

To operate the CD changer

Turn the CD changer ON before trying to operate it by remote control.
 Make sure the remote control is in the CD changer operation mode. (⇒ Page 44.)

Point the remote control toward the CD changer

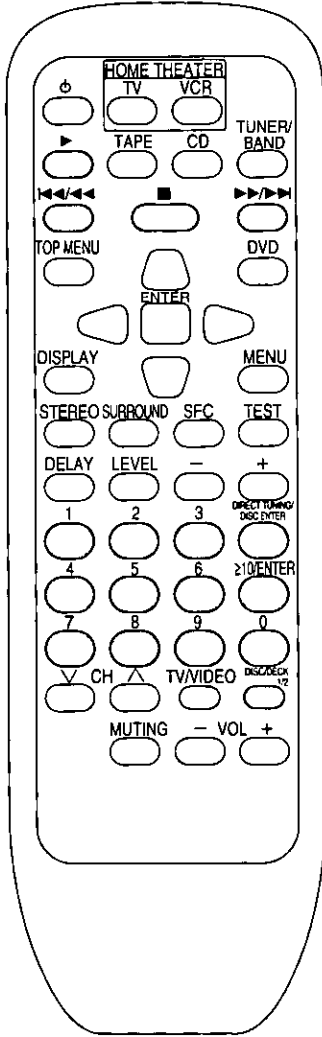

To start play



To start play from the desired disc

For SL-MC59

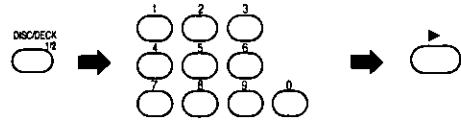

Select the disc number.
 (When selecting discs, [≥10/ENTER] does not respond to touch.)

For your reference



If you press this button instead of [▶] shown in the above procedure, the CD changer will stop and display the disc number. To start the disc, press [▶].

For 5 CD changer

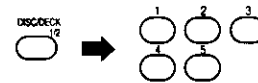

To start play from the desired track

Select the track number.

(Example: Track 1)

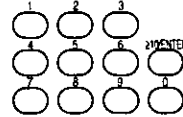

(Example: Track 10)

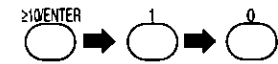

To skip a track



To stop play



To watch TV broadcasts

The procedures below are examples for when a TV and VCR are connected to the receiver as shown in this manual. This remote control transmitter is designed for use with a home theater system. If you press [TV] (or [VCR]) and [⏻] in succession, the TV (or VCR) and receiver will be turned on and the selector on the receiver will change to TV (or VCR). Press [⏻] within 3 seconds of pressing [TV] (or [VCR]).

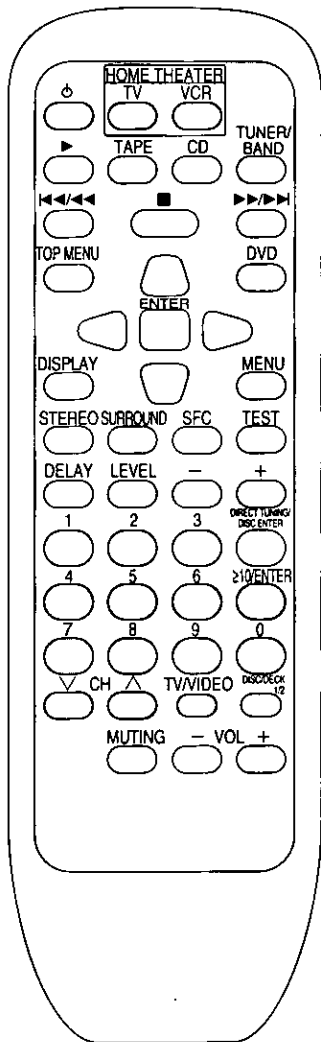

To watch TV broadcasts

Point the remote control toward the TV and the receiver



Switch ON the TV and the receiver.
The receiver will switch to TV input.

Point the remote control toward the TV



Set the TV/VIDEO mode on the TV to "TV".

Point the remote control toward the TV

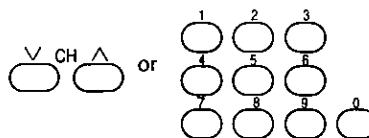

Select the desired channel.

Note

If you allow more than 3 seconds to pass between pressing [TV] and [⏻], only the TV will be operated.
Do not use this remote control to turn the TV ON and OFF if you are not using the receiver.

To watch TV broadcasts with a VCR tuner

Point the remote control toward the TV and the receiver



Switch ON the TV and the receiver.

Point the remote control toward the VCR and the receiver



Switch ON the VCR.
The receiver will switch to VCR input.

Set the input selector on the VCR to the "TUNER" position

Point the remote control toward the VCR

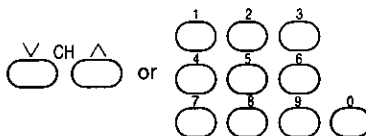

Select the desired channel.

Point the remote control toward the TV

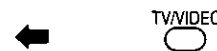

Set the TV/VIDEO mode on the TV to "VIDEO".

Note

If you allow more than 3 seconds to pass between pressing [VCR] and [⏻], only the VCR will be operated.
Do not use this remote control to turn the VCR ON and OFF if you are not using the receiver.

To switch OFF the TV To switch OFF the VCR



Note

Turn the receiver OFF last.



This button is used when using ENTER to select a channel on a TV or VCR which has not been manufactured by this company.

To watch video tapes

The procedure below are examples for when a TV and VCR are connected to the receiver as shown in this manual.

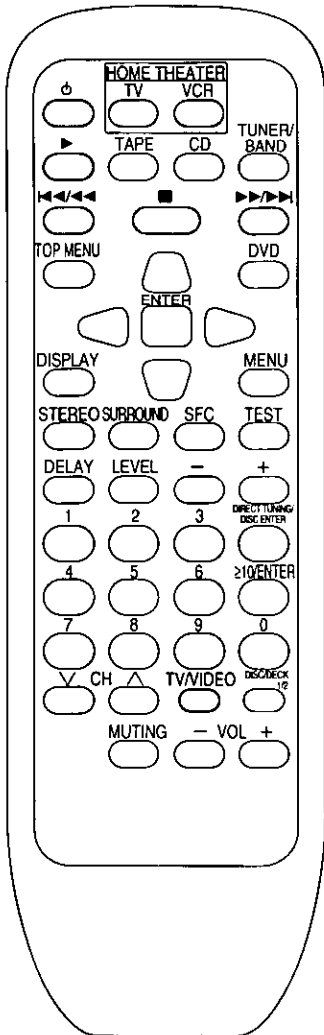

To watch video tapes

Point the remote control toward the TV and the receiver

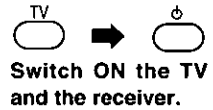

Point the remote control toward the VCR and the receiver

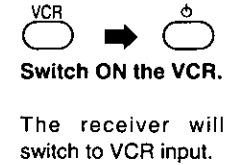

Point the remote control toward the TV

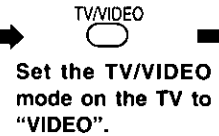

Point the remote control toward the VCR



To fast-forward or rewind the video tape

In the stop mode



To stop playback



To switch OFF the TV



To switch OFF the VCR



Note

Turn the receiver OFF last.

To operate a DVD player

The procedures below are examples for when a TV and DVD player are connected to the receiver as shown in this manual. **Make sure the remote control is in the DVD player operation mode.** (→ Page 44.) Actual operations depend on your equipment and software.

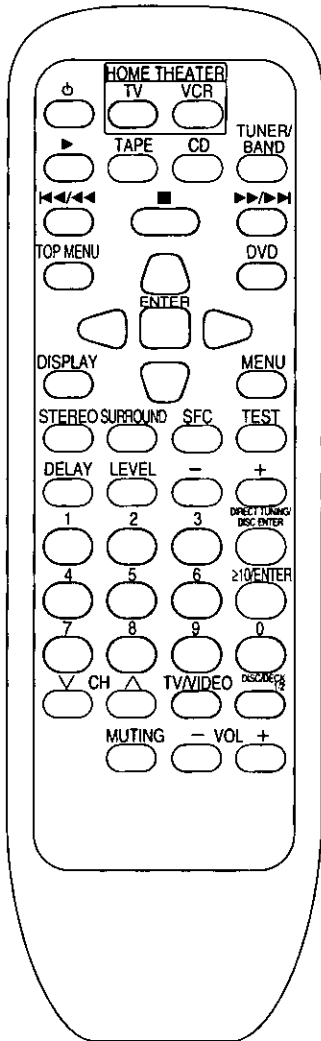

To enjoy DVDs

Point the remote control toward the TV and the receiver



Switch ON the TV and the receiver.

Point the remote control toward the DVD player and the receiver

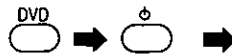

Switch ON the DVD player.

The receiver will switch the DVD input.

Point the remote control toward the TV



Set the TV/VIDEO mode on the TV to "VIDEO".

Point the remote control toward the DVD player.

Play will begin.

[DVD changer only]
To start play from the desired disc

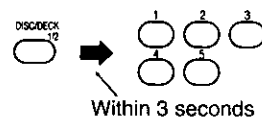

Select disc number.

To select the top menu

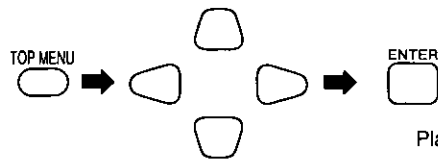

Play will begin.

To use the menu

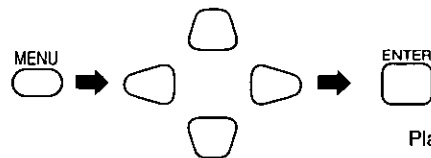

Play will begin.

To use on-screen graphic controls
(Graphic user interfaces, GUI, are a feature of some DVD players. See your player's manual for details.)

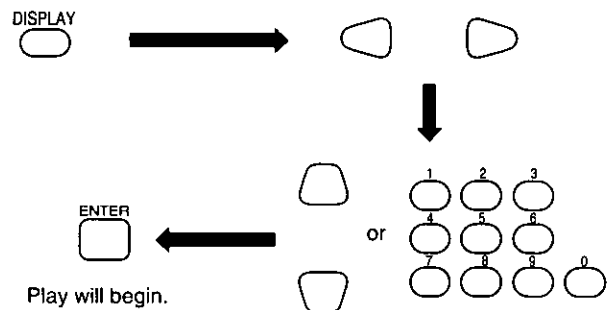

Play will begin.

To skip to the beginning of a track or chapter



To stop play



To switch OFF the TV



To switch OFF the DVD player



Note

Turn the receiver OFF last.

Changing the remote control code

Changing the remote control code in either of the following circumstances:

- If the Panasonic TV or VCR does not operate as a result of a difference in the remote control code.
- If you wish to operate some other make of TV or VCR.
(→ pages 47 and 48 for the buttons which can be used.)

Note

Even after changing the code there may be cases where certain operations cannot be done or operation is not possible at all.

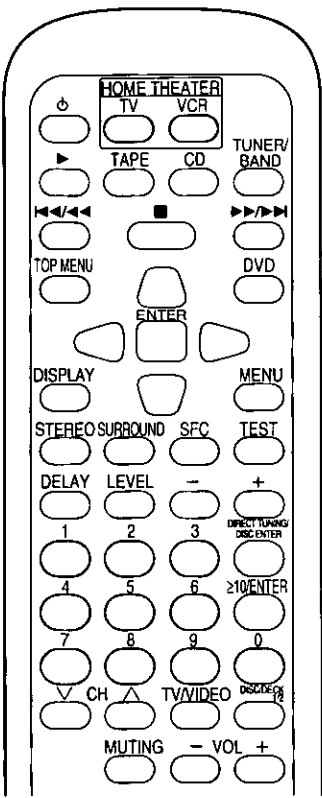

How to change the remote control code

TV
VCR

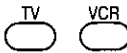

Hold down the button corresponding to the component you wish to operate.

Continue to hold the button down and...

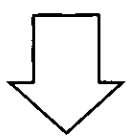

Aim the remote control at the component you wish to operate and carefully and slowly press the numbered buttons to enter the appropriate two-digit code number.
(Refer to the table below for the code number.)

When the two-digit code number is entered, the remote control will automatically output the on/off signal.

If the remote control has been correctly changed to the code for the component to be operated, the component will be switched ON or OFF.

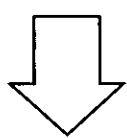

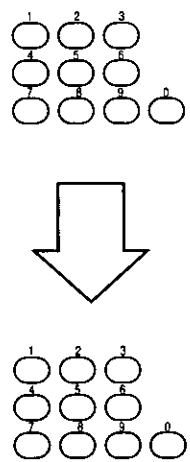

Remote control operation

TV				VCR			
Manufacturer	Code No.	Manufacturer	Code No.	Manufacturer	Code No.	Manufacturer	Code No.
Panasonic	01,02,20	RCA	03,07,09,13,23	Panasonic	01,02,09,33	Philips	02,09,12
Sony	04		24,25	Sony	05,06,07,35,36	Pioneer	09
Fisher	14	Sanyo	14	37	Quasar	01,02,09,33	
G-E	02,03,07,09	Sharp	08,21	Fisher	13,14,15,18	RCA	02,03,04,09,10
Gold Star	07,15	Sylvania	06,07,15	Funai	08,30		11,12,23,24,26
Hitachi	05,07	Symphonic	17	G-E	02,03,11	Sanyo	14,18
JVC	12	Toshiba	10,21	Gold Star	27	Sharp	16,17
LXI	03,06,07,10,14	Zenith	18,26	Hitachi	09,10,11	Shintom	32
	15			JVC	19,25,31,38,39	Sylvania	02,09,12,30
Magnavox	06,07,11,15,22			40		Symphonic	30
Mitsubishi	07,15,16,21			LXI	10,13,14,15,18	Toshiba	23,24
NEC	07,15				27,30	Zenith	20
Philco	06,07			Magnavox	02,09,12		
Philips	06			Mitsubishi	21,22,28,29		
Pioneer	02,10,19			NEC	19,25,31,38		
Quasar	02			Philco	02,09,12,30		

Note

Changes to the codes are cancelled when the remote control's batteries are replaced. Repeat the above operation to reenter the code.

Reference for speakers

The speaker indicators

This part of the display indicates which speakers sound comes from.

The corresponding indicators will not light if you selected "NONE" during the speaker setting procedure, or if you turned the subwoofer off.

The surround and center speaker indicators do not light when STEREO mode is selected (➔ page 40).

Front, center, and surround channel settings

The following settings may be necessary if you replace the speakers included with this unit. They should be performed in this case to get the most from this unit's reproduction modes (➔ page 40, 42).

Set the SIZE, DISTANCE, and FILTER for your speakers.

In SIZE

Set the type (LARGE or SMALL) and presence of your speakers. Select "LARGE" if the speakers can produce bass (below around 100 Hz). Select "SMALL" if the speakers cannot produce bass. If you aren't using center or surround speakers select "NONE" so the sound is produced through the front speakers.

In DISTANCE

Enter the distance of each speaker from the listening position so the sound from the speakers reaches the listening position at the same time. The unit calculates the delay time for the center and surround speakers based on these distances.

In FILTER

Enter the cutoff frequency for your subwoofer based on the bass capability of your front speakers. The factory setting is 100 Hz.

1 Press [POWER] on the receiver.

2 Press [A] and [B] at the same time.
"SETTING" appears on the display.

3 Press [A] to select what you want to set.
Each time the button is pressed the display switches as follows,
SIZE → DISTANCE → FILTER → DR COMP

4 When "SIZE" is selected

① Press [B] to select the speaker channel to be set.

Each time the buttons is pressed the display switches as follows.

FRONT → CENTER → SURROUND

② Turn [SFC MODE] to set the type (LARGE, SMALL) of the speaker.

Each time the selector is turned the display switches as follows.

Front:
LARGE ↔ SMALL

Center, Surround:
LARGE ↔ SMALL ↔ NONE

The factory settings are as follows.

Front speakers: LARGE

Center and surround speakers: SMALL

③ Repeat steps ① and ② to complete the size settings for the front, center and surround speakers.

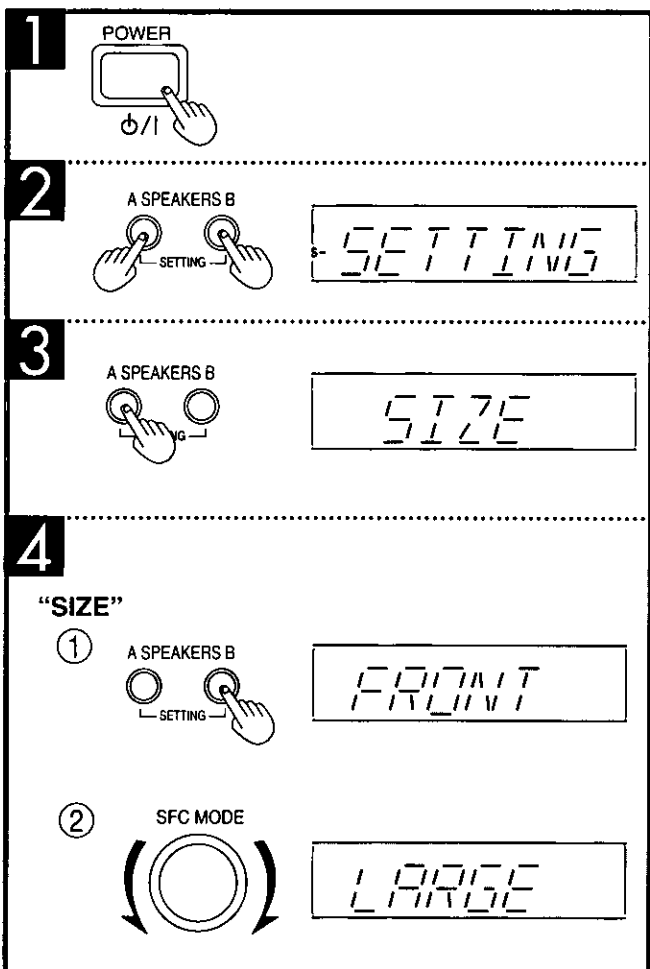
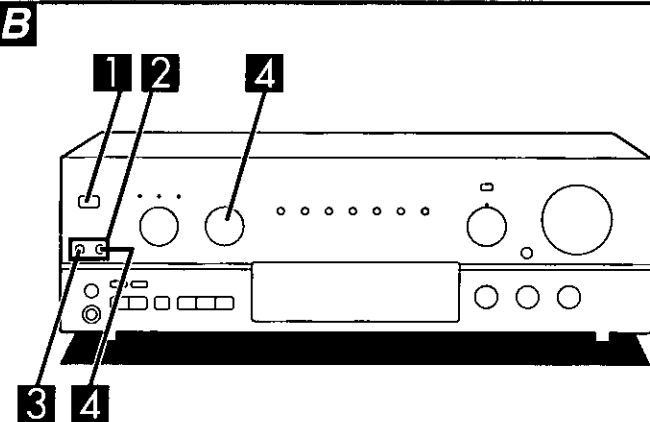
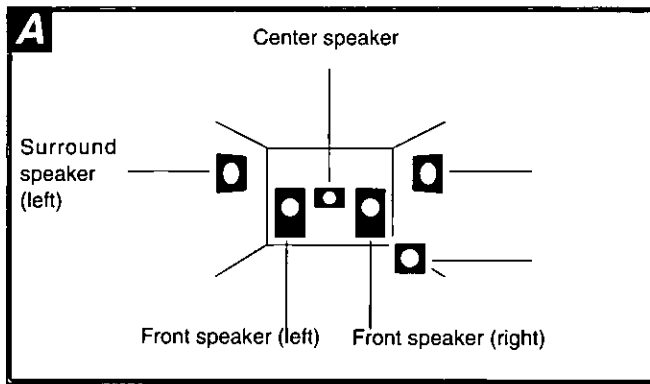

Preparatory steps

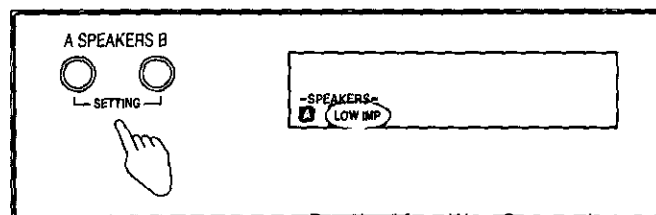
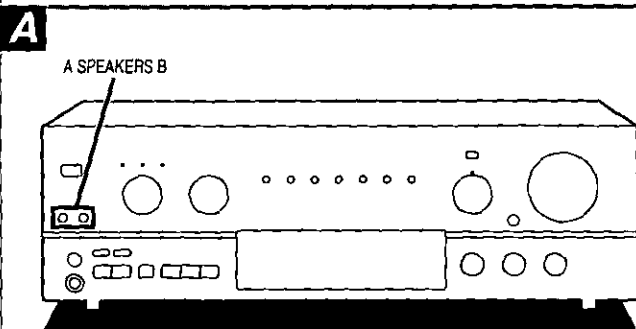
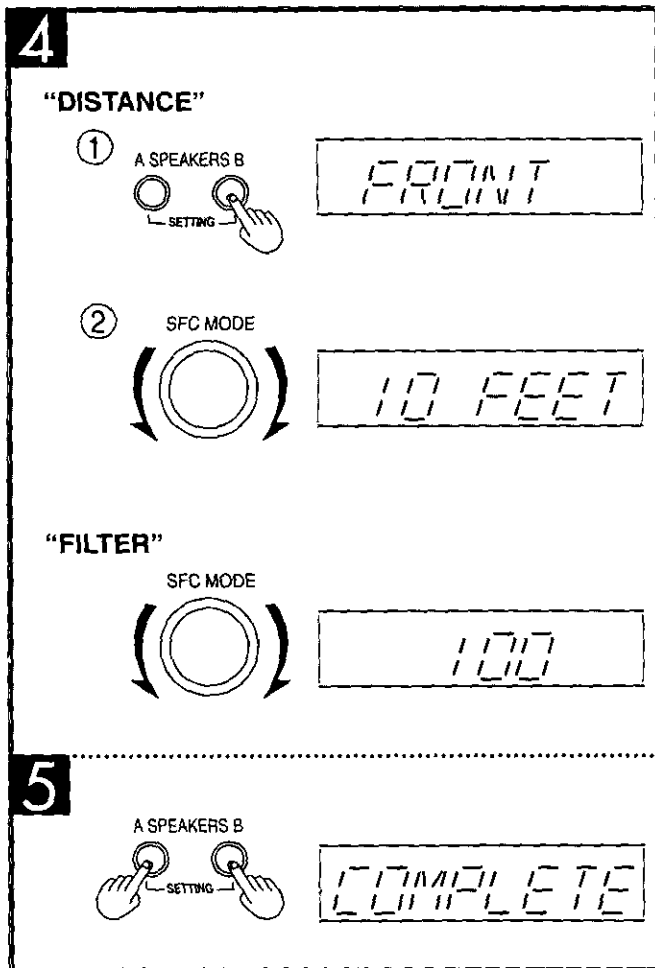
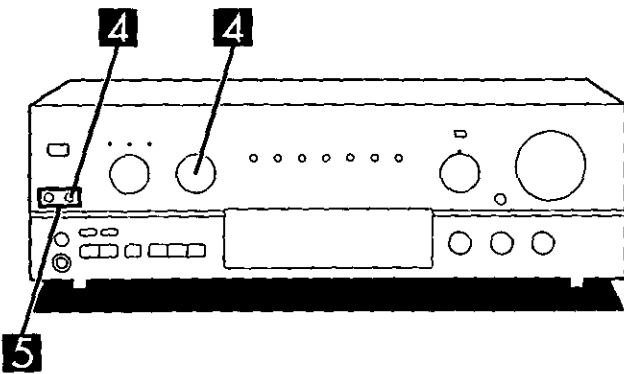

4 When "DISTANCE" is selected

- ① Press [B] to select the speaker channel to be set.
Each time the selector is turned the display switches as follows.
FRONT → CENTER → SURROUND
- ② Turn [SFC MODE] to set the distance.
Distance can be set at 1 foot intervals between 3 feet to 20 feet.
The factory settings are as follows.
Front and center speakers: 10 FEET
Surround speakers: 5 FEET
- ③ Repeat steps ① and ② to complete the distance settings for the front, center and surround speakers.

When "FILTER" is selected

- Turn [SFC MODE] to set the cut off frequency.
Each time the buttons is pressed the display switches as follows.
100 ↔ 150 ↔ 200 (Hz)

- 5 Press [A] and [B] at the same time.
"COMPLETE" appears on the display.

If you allow about 10 seconds to elapse between setting, the procedure is cancelled, all settings are returned to how they were, and the previous display is restored. Begin again if this occurs.

For your reference:

The settings remain as they are until changed by the above procedure, even after the power has been turned off.

For front speakers with an impedance under 8 Ω ^A

Press and hold [A] or [B] until "LOW IMP" lights up on the display.

If even one of the speakers being used has an impedance under 8 Ω, press and hold down either [A] or [B] for 4 seconds or more to set the impedance on the main unit to low.

(Press and hold down once again for 4 seconds or more to turn it off.)

Note that when "LOW IMP" is illuminated, speakers A and B cannot both be used at the same time.

To change a speaker:

e. g. To use speaker B, press [A] ("A" goes out), and then press [B] to activate speaker B.

Note

No settings are necessary when using the speakers included with this unit. Settings may need to be changed if you replace the speakers.

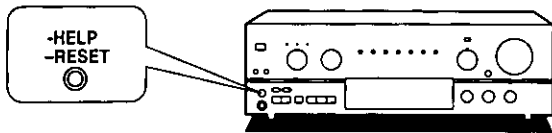

If you make a mistake in operation or if sound output stops due to some operation which was performed, the HELP function displays information which can be useful for indicating the method by which this condition can be remedied.

If "ERROR" or scrolling characters (for instance, "SPEAKER OFF NOW") appear on the display during operation, carry out the following operation.

Press [-HELP, -RESET].

The method for remedying this situation will be displayed.

For your reference

If the above button is pressed for 2 seconds or more until "RESET" appears on the display, the operation settings for the unit will be initialized to the settings made at the time of shipment.

However, any stations which have been preset into memory will not be erased at this time.

Listening caution



Selecting fine audio equipment such as the unit you've just purchased is only the start of your musical enjoyment. Now it's time to consider how you can maximize the fun and excitement your equipment offers. This manufacturer and the Electronic Industries Association's Consumer Electronics Group want you to get the most out of your equipment by playing it at a safe level. One that lets the sound come through loud and clear without annoying blaring or distortion-and, most importantly, without affecting your sensitive hearing.

We recommend you to avoid prolonged exposure to excessive noise.

Sound can be deceiving. Over time your hearing "comfort level" adapts to higher volumes of sound. So what sounds "normal" can actually be loud and harmful to your hearing.

Guard against this by setting your equipment at a safe level BEFORE your hearing adapts.

To establish a safe level:

- Start your volume control at a low setting.
- Slowly increase the sound until you can hear it comfortably and clearly, and without distortion.

Once you have established a comfortable sound level:

- Set the dial and leave it there.

Taking a minute to do this now will help to prevent hearing damage or loss in the future. After all, we want you listening for a lifetime.

Maintenance

Head care (Only for cassette deck)

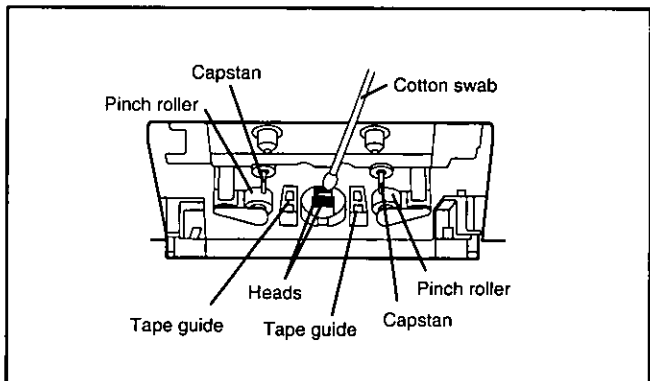

To assure good sound quality for recording and playback, be sure to clean the heads after approximately every 10 hours of use.

- 1) Press [OPEN] to open the cassette holder.
- 2) **Switch off the power of the cassette deck.**
- 3) Clean the heads, pinch roller, capstan shaft and the tape guide with a cotton swab (or with a soft, lint-free cloth) slightly moistened with isopropyl alcohol.

Do not use any solution other than alcohol for head cleaning.

If the surfaces are dirty

To clean this unit, wipe with a soft, dry cloth.

If the surfaces are extremely dirty, use a soft cloth dipped in a soap-and-water solution or a weak detergent solution.

- Never use alcohol, paint thinner or benzine to clean this unit.
- Before using chemically treated cloth, read the instructions that came with the cloth carefully.

Receiver SA-G90

■ **AMPLIFIER SECTION**

Rated minimum sine wave RMS power output
 20 Hz–20 kHz both channel driven
 0.05% total harmonic distortion

100 W per channel (8 Ω)

1 kHz continuous power output both channels driven

0.05% total harmonic distortion 105 W per channel (8 Ω)

Total harmonic distortion

rated power at 20 Hz–20 kHz 0.05% (8 Ω)

half power at 1 kHz 0.03% (8 Ω)

Power output at 1 kHz each channel driven

0.9% total harmonic distortion

Front 2 X 100 W (8 Ω)

Center 100 W (8 Ω)

Surround 2 X 100 W (8 Ω)

Low frequency damping factor

30 (8 Ω)

Load impedance

Front

A or B 4–8 Ω

A and B 8 Ω

Center 8 Ω

Surround 8 Ω

Dynamic headroom

2 dB (8 Ω)

Frequency response

PHONO RIAA standard curve ±0.8 dB

CD, TAPE, DVD, TV, VCR 10 Hz–70 kHz, ±3 dB

Input sensitivity

PHONO 0.4 mV (3 mV, IHF'66)

CD, TAPE, DVD, TV, VCR 27 mV (200 mV, IHF'66)

S/N (IHF A)

PHONO 70 dB (80 dB, IHF'66)

CD, TAPE, DVD, TV, VCR 75 dB (85 dB, IHF'66)

Input impedance

PHONO 47 kΩ

CD, TAPE, DVD, TV, VCR 22 kΩ

Tone controls

BASS 50 Hz, +10 to –10 dB

TREBLE 20 kHz, +10 to –10 dB

Subwoofer frequency response (–6 dB)

7–200 Hz

Digital input

Optical CD, DVD, TV

■ **FM TUNER SECTION**

Frequency range 87.9–107.9 MHz

Sensitivity 11.2 dBf (2 μV, IHF'58)

50 dB quieting sensitivity

MONO 18.3 dBf (4.5 μV, IHF'58)

STEREO 38.3 dBf (45 μV, IHF'58)

Total harmonic distortion

MONO 0.2%

STEREO 0.3%

S/N

MONO 73 dB

STEREO 67 dB

Frequency response 20 Hz–15 kHz, +1 dB, –2 dB

Alternate channel selectivity 65 dB

Capture ratio 1.5 dB

Image rejection at 98 MHz 40 dB

Spurious response rejection at 98 MHz 75 dB

AM suppression 50 dB

Stereo separation

1 kHz 40 dB

10 kHz 30 dB

Antenna terminal 75 Ω (unbalanced)

■ **AM TUNER SECTION**

Frequency range 530–1710 kHz

Sensitivity 20 μV, 330 μV/m

Selectivity 55 dB

IF rejection at 1000 kHz 50 dB

■ **VIDEO SECTION**

Output voltage at 1 V input (unbalanced) 1±0.1 Vp-p

Maximum input voltage 1.5 Vp-p

Input/output impedance 75 Ω

■ **GENERAL**

Power supply AC 120 V, 60 Hz

Power consumption 380 VA, 290 W

Dimensions (W X H X D) 430 X 158 X 320.5 mm
 (16–15/16" X 6–7/32" X 12–5/8")

Mass 9.6 kg (21.3 lb.)

Power consumption in standby mode: 1 W

Note:

- Specifications are subject to change without notice. Mass and dimensions are approximate.
- Total harmonic distortion is measured by the digital spectrum analyzer.

CD changer SL-MC59

■ **AUDIO**

No. of channels 2 (left and right, stereo)

Frequency response 2–20,000 Hz, ±1 dB

Output voltage 2 V (at 0 dB)

Dynamic range 92 dB

S/N 100 dB

Total harmonic distortion 0.007% (1 kHz, 0 dB)

Wow and flutter Below measurable limit

DA converter MASH (1 bit)

Output impedance Approx. 1 kΩ

Load impedance More than 10 kΩ

■ **PICKUP**

Wavelength 780 nm

■ **GENERAL**

Power supply AC 120 V, 60 Hz

Power consumption 11 W

Dimensions (W X H X D) 430 X 170 X 387 mm
 (16–15/16" X 6–11/16" X 15–1/4")

Mass 6.3 kg (13.9 lb.)

Power consumption in standby mode: 2.8 W

Note:

- Specifications are subject to change without notice. Mass and dimensions are approximate.

Cassette deck RS-TR180

■ CASSETTE DECK SECTION

Deck system	Stereo cassette deck
Track system	4 track, 2 channel
Recording system	AC bias
Bias frequency	80 kHz (approx.)
Erasing system	AC erase
Heads	
DECK 1	Playback head (Permalloy) X 1
DECK 2	Recording/Playback head (Permalloy) X 1 Erasing head (Double-gap ferrite) X 1

Motors

DECK 1	Capstan/Reel table drive (DC servo motor) X 1
DECK 2	Capstan/Reel table drive (DC servo motor) X 1

Tape speed 4.8 cm/s (1-7/8 ips)

Wow and flutter 0.18% (WRMS)

Fast forward and rewind times

Approx. 120 seconds with C-60 cassette tape

Frequency response (Dolby NR off)

TYPE I (NORMAL)	40 Hz-14 kHz, ±3 dB 20 Hz-17 kHz
TYPE II (HIGH POSITION)	40 Hz-14 kHz, ±3 dB 20 Hz-17 kHz
TYPE IV (METAL)	40 Hz-15 kHz, ±3 dB 20 Hz-18 kHz

S/N

(signal level=max recording level, HIGH POSITION type tape)

NR off	54 dB (A weighted)
Dolby B NR on	64 dB (A weighted)

Input sensitivity and impedance

REC (IN) 500 mV/47 kΩ

Output voltage and impedance

PLAY (OUT) 500 mV/500 Ω

■ GENERAL

Power supply AC 120 V, 60 Hz

Power consumption 18 W

Dimensions (W X H X D) 430 X 131 X 286 mm
(16-15/16" X 5-5/32" X 11-1/4")

Mass 3.8 kg (8.5 lb.)

Power consumption in standby mode: 3.6 W

Note:

Specifications are subject to change without notice.

Mass and dimensions are approximate.

Front speakers SB-A28

Type	3 way 3 speaker bass-reflex
Speaker(s)	
Woofer	30 cm (11-13/16") cone type
Midrange	10 cm (3-15/16") cone type
Tweeter	6.5 cm (2-9/16") cone type
Impedance	8 Ω
Input power	240 W (MUSIC) 120 W (DIN)
Output sound pressure level	89 dB/W (1.0 m)
Crossover frequency	3 kHz, 6 kHz
Frequency range	35 Hz-35 kHz (-16 dB) 43 Hz-31 kHz (-10 dB)
Dimensions (W X H X D)	380 X 900 X 285 mm (14-31/32" X 35-7/16" X 11-7/32")
Mass	12 kg (26.4 lb.)

Note:

Specifications are subject to change without notice.

Mass and dimensions are approximate.

Surround speakers SB-S948

Type	1 way 2 speaker Bass-reflex
Speaker(s)	
Full range	8 cm (3-5/32") corn type X 2
Impedance	8 Ω
Input power	200 W (MUSIC) 100 W (DIN)
Output sound pressure level	86 dB/W (1.0 m)
Frequency range	135 Hz-20 kHz (-16 dB) 165 Hz-18 kHz (-10 dB)
Dimensions (W X H X D)	170 X 240 X 100 mm (6-11/16" X 9-7/16" X 3-15/16")
Mass	1.6 kg (3.53 lb.)

Note:

Specifications are subject to change without notice.

Mass and dimensions are approximate.

Center speaker SB-C938

Type	1 way 2 speaker bass-reflex
Speaker(s)	
Full range	8 cm (3-5/32") cone type X 2
Impedance	8 Ω
Input power	220 W (MUSIC) 110 W (DIN)
Output sound pressure level	87 dB/W (1.0 m)
Frequency range	130 Hz-20 kHz (-16 dB) 170 Hz-18 kHz (-10 dB)
Dimensions (W X H X D)	320 X 130 X 100 mm (12-5/8" X 5-1/8" X 3-15/16")
Mass	1.7 kg (3.8 lb.)

Note:

Specifications are subject to change without notice.

Mass and dimensions are approximate.

Product service

Do not attempt to remove the cover(s) or repair the unit yourself. Refer servicing to qualified personnel only.

Product information

For product service, product information or assistance in product operation, refer to the servicenter list.

When getting service

Before bringing in your changer for service, be sure to remove all discs.

If the disc in play doesn't return to its slot when you press [■], hold the button down for about 4 seconds. The disc should return to the slot.

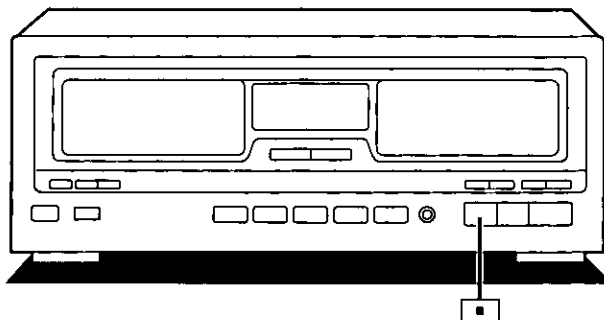

Troubleshooting guide

Before requesting service for this unit, check the chart below for a possible cause of the problem you are experiencing. Some simple checks or a minor adjustment on your part may eliminate the problem and restore proper operation.

If you are in doubt about some of the check points, or if the remedies indicated in the chart do not solve the problem, refer to the directory of Authorized Service Centers (enclosed with this unit) to locate a convenient service center, or consult your dealer for instructions.

For detailed instructions, contact an authorized servicer in the U.S.A. and Panasonic Canada Inc. Customer Care Centre in Canada.

In the U.S.A. 1-800-211-7262 or web site

(<http://www.panasonic.com>)

In Canada 905-624-5505 or web site

(www.panasonic.ca)

Problem	Probable cause(s)	Suggested remedy	Page(s)
---------	-------------------	------------------	---------

Common Problems			
Sound is not heard when the power is switch on.	The power cord plug is not fully inserted.	• Confirm the plug is fully inserted.	–
	Incomplete or incorrect connection to the speaker systems, etc.	• Check all connections.	7–12
	The speakers indicators are off.	• Turn on the speaker indicators.	18
	The tape monitor function is on.	• Press the tape monitor button.	18, 36
	The input selector is set incorrectly.	• Select the correct source.	18
When listening to stereo sound, the sound lacks depth (i.e. thin bass, tinny sound).	One of the speakers is connected out of phase [(+) → (-), (-) → (+)].	• Reconnect the speakers maintaining proper polarity [i.e., (+) → (+), (-) → (-)].	11, 12
When listening to stereo sound, the left and right sounds are reversed.	The left and right speaker connections, or source connections, are reversed.	• Check all connections and correct them if necessary.	7–12
A low-pitched noise ("hum" or "buzz") is heard.	A power cord, fluorescent light, etc., is near the connection wires.	• Try separating this unit as far as possible from the electric appliance.	–
Sound is not heard from one of the speaker systems.	The speaker wires are disconnected.	• Check and correct the connections of the speaker wires.	–
	The balance control is set too far to one side.	• Set so that sounds are heard at the center, between the speaker systems.	35
Cannot play CD, DVD, or TV.	The DIGITAL input mode is set to DIGITAL or ANALOG.	• Change the setting to suit the type of connection you have made.	35
Sound suddenly stops or none is heard when the power is switched on. "OVERLOAD" appears on the display of receiver.	The protection circuitry has functioned because the positive and negative speaker wires are shorted; speakers with a lower impedance than the receiver rated impedance are being used; the speakers are under strain through excessive volume, excessive power, or by being used in a high temperature environment.	• Switch off the power, and, after determining and correcting the cause, switch the power on.	–
		• Use a speaker system of the right impedance rating.	11, 12
"F70" appears on the display of receiver.		• Turn off the power and then turn it on again, or disconnect the AC power supply cord and then connect it to your household AC outlet again. (If "F70" remains on the display, consult an authorized service center or your dealer.)	–

While enjoying the surround modes			
Sound is not heard from the center, surround or subwoofer speakers.	The presence setting of the speaker has been incorrectly set to "NONE" or "OFF".	• Set the type and presence setting of each speaker correctly.	51, 52
	The presence mode setting has been incorrectly set to "STEREO".	• Set the SURROUND mode.	40
SURROUND and SFC cannot be selected.	DSP is off.	• Select "DSP ON".	42
	Speaker B is on.	• Turns SPEAKERS B off.	40
Cannot play Dby Digital or DTS sources.	The PCM FIX mode may be on.	• Turn PCM FIX mode off.	40
	An SFC mode is on.	• Switch to SURROUND or STEREO mode.	40

Problem	Probable cause(s)	Suggested remedy	Page(s)
---------	-------------------	------------------	---------

While listening to FM broadcasts			
Hissing is heard during stereo broadcasts, but not during monaural ones.	Modulation for the two types is different so some noise may be heard during stereo broadcasts.	<ul style="list-style-type: none"> ● Reduce the treble sound by using the treble control of the receiver. ● Changing the location and direction of the antenna. 	35
	Excessive noise in both stereo and monaural broadcasts.	<ul style="list-style-type: none"> ● Use an outdoor antenna. ● Use an antenna with more elements. 	10
"STEREO" and "TUNED" indicators flicker.	Antenna location and direction poor.	<ul style="list-style-type: none"> ● Select "DSP DEFEAT". 	10
	Station is distant.		10
Stereo broadcasts highly distorted.	DSP is on.	<ul style="list-style-type: none"> ● Use an outdoor antenna. ● Use an antenna with more elements. 	42
	Building or mountain nearby.		10
Sound is distorted, "popping" noise is heard, and/or the volume level becomes low.	Broadcast signals are being disturbed by nearby automobile traffic or airplanes.	<ul style="list-style-type: none"> ● Relocate the antenna and the connection wires to a place farther away from where automobiles pass. 	-

While listening to AM broadcasts			
Unusual "beat" sound is heard.	A television is on nearby.	<ul style="list-style-type: none"> ● Separate the two or turn the television off. 	-
	Adjacent signal is interfering.	<ul style="list-style-type: none"> ● Reduce the treble. 	35
	DSP is on.	<ul style="list-style-type: none"> ● Select "DSP DEFEAT". 	42
Low-pitched "hum" sound is heard when the a station is tuned.	Power cord is near the antenna wires.	<ul style="list-style-type: none"> ● Separate the power cord from the wires. 	-
	Electronic interference from the power cord is fed to the speakers.	<ul style="list-style-type: none"> ● Use an outdoor antenna. 	-
A continuous or intermittent hiss is heard.	Interference from other appliances, fluorescent light, TVs, small motors, etc., through discharge and oscillation.	<ul style="list-style-type: none"> ● Separate this system from such appliances. ● Install noise-prevention equipment on this unit or on the electric appliance. 	-

While using the cassette deck			
Previously recorded sound has not been erased.	Erase head is dirty.	<ul style="list-style-type: none"> ● Clean the head. 	53
Sound output is hoarse or unsteady.	Heads are dirty.	<ul style="list-style-type: none"> ● Clean the heads. 	53
	Tape is damaged.	<ul style="list-style-type: none"> ● Try operation with a new cassette; if there is no problem with the new cassette, discard the damaged cassette. 	-
Poor sound quality (especially in the high treble and low bass ranges).	The Dolby noise-reduction function is off.	<ul style="list-style-type: none"> ● Press [DOLBY NR] button. 	32
Sound is low, poor tone, intermittent sound, noise.	Heads, capstan and/or pinch roller are dirty.	<ul style="list-style-type: none"> ● Clean the heads, capstan and/or pinch roller. 	53
	Tape is damaged.	<ul style="list-style-type: none"> ● Try operation with a new tape. 	-
There is a lot of noise, and the treble is drowned out.	The heads have been magnetized.	<ul style="list-style-type: none"> ● Demagnetize the heads with a commercially sold magnetic eraser. 	-
Recording is not possible.	One of the tape-to-tape recording-speed indicators is illuminated.	Switch off whichever tape-to-tape recording-speed indicator is illuminated (by pressing the SPEED button).	38
Recorded sound is TV noise.	This unit is placed near a TV.	<ul style="list-style-type: none"> ● Try placing this unit further away from a TV. 	-

Problem	Probable cause(s)	Suggested remedy	Page(s)
While listening to compact discs			
Changer will not play.	A disc(s) or other foreign object(s) has fallen inside the changer.	• Open the front panel and remove the object.	-
	Moisture has collected in the changer.	• Allow the changer to dry out for about one hour before using it.	-
The disc in the changer does not play.	The disc label is facing left.	• Set the disc with the label facing right.	14
	The disc is dirty.	• Wipe the disc with a soft cloth.	15
	The disc is scratched.	• Replace the disc with a new one.	-
	The disc is warped.		
The disc is not within specified standards.			
Play stops before changing to the next disc.	The front panel is open.	• Close the panel.	-
A certain music passage can't be played correctly.	The disc is dirty.	• Wipe the disc with a soft cloth.	15
	The disc is scratched.	• Replace the disc with a new one.	-
There is noise from the tuner or disturbance on the TV screen.	Caused by high-frequency signals from this changer.	• Use the changer further away from the tuner or TV. • If the tuner or TV's antenna is the indoor type, use an outdoor one.	-
The error message "NO PGM" appears on the display, when program play is started.	Play was started without a track being programmed.	• Program a track.	28
The error message "ERROR" appears on the display, and the changer stops operating.	The mechanism of the changer has been improperly adjusted.	• Turn the unit off and then back on again.	-
The error message "F-26" appears on the display and the changer stops operating.	The servo LSI has malfunctioned.	• Unplug the changer from its outlet, replug it in and turn the changer ON again.	-
The error message "TAKE OUT" appears on the display and the changer stops operating.	A disc has been put in the slot of the disc in play.	• Remove the disc whose number is displayed and press the stop button.	-
	Because of light or noise, the changer has detected a disc in the slot of the disc being played, even though it is empty.	• Check whether there is a disc in the displayed slot. With the front panel close, hold down [■] for at least 4 seconds.	-

While using the remote control transmitter			
Remote control transmitter does not function.	Batteries are incorrectly installed.	• Insert the batteries so that the positive (+) and negative (-) polarities are correct.	13
	The remote control transmitter batteries are drained.	• Replace them with new batteries.	13
	There is an obstruction between the remote control transmitter and the system components.	• Remove the obstruction.	-
	The remote control transmitter is not correctly facing the system components.	• Face the remote control transmitter correctly toward the system components.	13

While using the graphic equalizer (Option: SH-GE50)			
Sound is distorted.	The TAPE, EQ switch on the back of the receiver is switched to TAPE.	• Set to EQ.	8
No sound.	Input on the graphic equalizer is set incorrectly.	• Correct the setting. Read the graphic equalizer's operating instructions for details.	-

No.	GROUP					DISC NAME
0	SINGLE					
1	A	B	C	D	E	
2	A	B	C	D	E	
3	A	B	C	D	E	
4	A	B	C	D	E	
5	A	B	C	D	E	
6	A	B	C	D	E	
7	A	B	C	D	E	
8	A	B	C	D	E	
9	A	B	C	D	E	
10	A	B	C	D	E	
11	A	B	C	D	E	
12	A	B	C	D	E	
13	A	B	C	D	E	
14	A	B	C	D	E	
15	A	B	C	D	E	
16	A	B	C	D	E	
17	A	B	C	D	E	
18	A	B	C	D	E	
19	A	B	C	D	E	
20	A	B	C	D	E	
21	A	B	C	D	E	
22	A	B	C	D	E	
23	A	B	C	D	E	
24	A	B	C	D	E	
25	A	B	C	D	E	
26	A	B	C	D	E	
27	A	B	C	D	E	
28	A	B	C	D	E	
29	A	B	C	D	E	
30	A	B	C	D	E	

No.	GROUP					DISC NAME
31	A	B	C	D	E	
32	A	B	C	D	E	
33	A	B	C	D	E	
34	A	B	C	D	E	
35	A	B	C	D	E	
36	A	B	C	D	E	
37	A	B	C	D	E	
38	A	B	C	D	E	
39	A	B	C	D	E	
40	A	B	C	D	E	
41	A	B	C	D	E	
42	A	B	C	D	E	
43	A	B	C	D	E	
44	A	B	C	D	E	
45	A	B	C	D	E	
46	A	B	C	D	E	
47	A	B	C	D	E	
48	A	B	C	D	E	
49	A	B	C	D	E	
50	A	B	C	D	E	
51	A	B	C	D	E	
52	A	B	C	D	E	
53	A	B	C	D	E	
54	A	B	C	D	E	
55	A	B	C	D	E	
56	A	B	C	D	E	
57	A	B	C	D	E	
58	A	B	C	D	E	
59	A	B	C	D	E	
60	A	B	C	D	E	

Write your group names in here.

GROUP	GROUP NAME
A	
B	
C	
D	
E	

Reference

Panasonic

Technics

Quasar

**For Product Information, Operating Assistance, Literature Request, Dealer Locations, and all Customer Service inquiries please contact:
1-800-211-PANA (7262), Monday-Friday 9 am-9 pm; Saturday-Sunday 9 am-7 pm, EST.**

**Web Site: <http://www.panasonic.com>
You can purchase parts, accessories or locate your nearest servicenter by visiting our Web Site.**

Accessory Purchases:

1-800-332-5368 (Customer Orders Only)
Panasonic Services Company 20421 84th Avenue South, Kent, WA
98032 (6 am to 5 pm Monday-Friday; 6 am to 10:30 am Saturday; PST)
(Visa, MasterCard, Discover Card, American Express, Check)

Factory Servicenters Locations			
<p>CALIFORNIA 6550 Katella Avenue Cypress, CA 90630</p> <p>800 Dubuque Avenue S. San Francisco CA 94080</p> <p>20201 Sherman Way Suite 102 Canoga Park, CA 91306</p> <p>3878 Ruffin Road Suite A San Diego, CA 92123</p> <p>COLORADO 1640 South Abilene Street Suite D Aurora, CO 80012</p> <p>FLORIDA 3700 North 29th Avenue Suite 102 Hollywood, FL 33020</p>	<p>GEORGIA 8655 Roswell Road Suite 100 Atlanta, GA 30350</p> <p>ILLINOIS 9060 Golf Road Niles, IL 60714</p> <p>1703 North Randall Road Elgin, IL 60123 (Pick-up/Drop-off only)</p> <p>MARYLAND 62 Mountain Road Glen Burnie, MD 21061</p> <p>MASSACHUSETTS 60 Glacier Drive Suite G Westwood, MA 02090</p>	<p>MICHIGAN 37048 Van Dyke Avenue Sterling Heights, MI 48312</p> <p>MINNESOTA 7850-12th Avenue South Airport Business Center Bloomington, MN 55425</p> <p>OHIO 2236 Waycross Road Civic Center Plaza Forest Park, OH 45240</p> <p>PENNSYLVANIA 2221 Cabot Blvd. West Suite B Langhorne, PA 19047</p> <p>Chartiers Valley Shopping Center 1025 Washington Pike Bridgeville, PA 15017</p>	<p>TENNESSEE 3800 Ezell Road Suite 806 Nashville, TN 37211</p> <p>TEXAS 7482 Harwin Drive Houston, TX 77036</p> <p>13615 Welch Road Suite 101 Farmers Branch TX 75244</p> <p>WASHINGTON 20425-84th Avenue South Kent, WA 98032</p> <p>HAWAII 99-859 Iwaiwa Street Aiea, Hawaii 96701 Phone (808) 488-1996 Fax (808) 486-4369</p>

Service in Puerto Rico
Matsushita Electric of Puerto Rico, Inc. Panasonic Sales Company/Factory Servicenter:
Ave. 65 de Infanteria, Km. 9.5, San Gabriel Industrial Park, Carolina, Puerto Rico 00985
Phone (787) 750-4300 Fax (787) 768-2910

Panasonic Consumer Electronics Company, Division of Matsushita Electric Corporation of America
One Panasonic Way Secaucus,
New Jersey 07094
<http://www.panasonic.com>

Panasonic Sales Company, Division of Matsushita Electric of Puerto Rico, Inc. ("PSC")
Ave. 65 de Infanteria, Km. 9.5
San Gabriel Industrial Park, Carolina,
Puerto Rico 00985

Panasonic Canada Inc.
5770 Ambler Drive
Mississauga, Ontario
L4W 2T3
www.panasonic.ca



Free Manuals Download Website

<http://myh66.com>

<http://usermanuals.us>

<http://www.somanuals.com>

<http://www.4manuals.cc>

<http://www.manual-lib.com>

<http://www.404manual.com>

<http://www.luxmanual.com>

<http://aubethermostatmanual.com>

Golf course search by state

<http://golfingnear.com>

Email search by domain

<http://emailbydomain.com>

Auto manuals search

<http://auto.somanuals.com>

TV manuals search

<http://tv.somanuals.com>