

Compact Disc Changer SL-MC7 SL-MC4

Operating Instructions

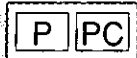

The photograph shows SL-MC7.



Technics®

Before connecting, operating or adjusting this product, please read these instructions completely. Please save this manual.

RQT4941-P

Supplied accessories

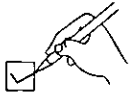

Please check and identify the supplied accessories.

- AC power supply cord (RJA0065-A) 1 pc.

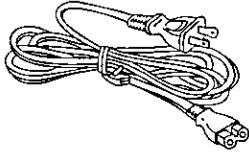

- Stereo connection cable (RJL2P004B08A) 1 pc.

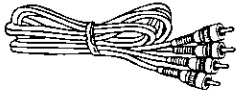

- Remote control transmitter (EUR645270) 1 pc.

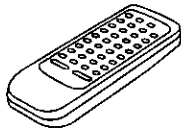

- Notebook-like binder [Liner notes organizer]
[SL-MC7] (RFA0623-K1)
[SL-MC4] (RFA0622-K1) 1 pc.

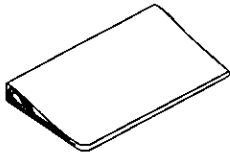

- Numbered stickers [SL-MC7] (RQLA0326)
[SL-MC4] (RQLA0321) 1 pc.

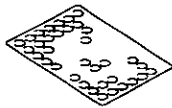

- Batteries 2 pcs.

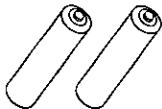

Use numbers indicated in parentheses when asking for replacement parts.

(Only for U.S.A.)

To order accessories contact 1-800-332-5368 or web site (<http://www.panasonic.com>).

Dear Customer

Thank you for purchasing this Technics product. For optimum performance and safety, please read these instructions carefully.

These operating instructions are applicable to the SL-MC7 and SL-MC4 models. These operating instructions, however, fundamentally explain the operation of SL-MC7.

Table of contents

Before use

Precautions	4
Connections	5
Preparing the remote control	5
Controls	6
Setting/Removing discs	7

Operations

Sequential play	8
Direct play	9
Single disc play	9
Program play	10
Direct programming	10
Random play	12
One disc random play	12
Full random play	12
Repeat function	13
ID scan function	13
Disc grouping play	14
To make groups	14
Playing back discs in a group	15
To name groups	16
CD-TEXT function	17
Displaying a CD's information	17
To search discs or tracks using text information (TEXT SEARCH)	18
Entering CD information manually (TEXT EDIT)	19
Time mode selection	20

Reference

A note on compact discs	21
The liner notes organizer	21
Troubleshooting guide	22
Maintenance	22
Product service	23
Technical specifications	23
Disc index	Back cover

The model number and serial number of this product can be found on either the back or the bottom of the unit. Please note them in the space provided below and keep for future reference.

MODEL NUMBER _____

SERIAL NUMBER _____

User memo:

DATE OF PURCHASE _____

DEALER NAME _____

DEALER ADDRESS _____

TELEPHONE NUMBER _____

THE FOLLOWING APPLIES ONLY IN THE U.S.A. _____

CAUTION:

This equipment has been tested and found to comply with the limits for a Class B digital device, pursuant to Part 15 of the FCC Rules. These limits are designed to provide reasonable protection against harmful interference in a residential installation. This equipment generates, uses and can radiate radio frequency energy and, if not installed and used in accordance with the instructions, may cause harmful interference to radio communications. However, there is no guarantee that interference will not occur in a particular installation. If this equipment does cause harmful interference to radio or television reception, which can be determined by turning the equipment off and on, the user is encouraged to try to correct the interference by one of the following measures:

- Reorient or relocate the receiving antenna.
- Increase the separation between the equipment and receiver.
- Connect the equipment into an outlet on a circuit different from that to which the receiver is connected.
- Consult the dealer or an experienced radio/TV technician for help.

Any unauthorized changes or modifications to this equipment would void the user's authority to operate this device.

This device complies with Part 15 of the FCC Rules. Operation is subject to the following two conditions: (1) This device may not cause harmful interference, and (2) this device must accept any interference received, including interference that may cause undesired operation.

CAUTION!

THIS PRODUCT UTILIZES A LASER. USE OF CONTROLS OR ADJUSTMENTS OR PERFORMANCE OF PROCEDURES OTHER THAN THOSE SPECIFIED HEREIN MAY RESULT IN HAZARDOUS RADIATION EXPOSURE. DO NOT OPEN COVERS AND DO NOT REPAIR YOURSELF. REFER SERVICING TO QUALIFIED PERSONNEL.

CAUTION:

TO PREVENT ELECTRIC SHOCK MATCH WIDE BLADE OF PLUG TO WIDE SLOT, FULLY INSERT.

WARNING:

TO REDUCE THE RISK OF FIRE, ELECTRIC SHOCK OR PRODUCT DAMAGE, DO NOT EXPOSE THIS APPLIANCE TO RAIN, SPLASHING, DRIPPING OR MOISTURE.

	CAUTION RISK OF ELECTRIC SHOCK DO NOT OPEN	
<p>CAUTION: TO REDUCE THE RISK OF ELECTRIC SHOCK, DO NOT REMOVE SCREWS. NO USER-SERVICEABLE PARTS INSIDE. REFER SERVICING TO QUALIFIED SERVICE PERSONNEL.</p>		



The lightning flash with arrowhead symbol, within an equilateral triangle, is intended to alert the user to the presence of uninsulated "dangerous voltage" within the product's enclosure that may be of sufficient magnitude to constitute a risk of electric shock to persons.



The exclamation point within an equilateral triangle is intended to alert the user to the presence of important operating and maintenance (servicing) instructions in the literature accompanying the appliance.

Precautions

Before using this unit please read these operating instructions carefully. Take special care to follow the warnings indicated on the unit itself as well as the safety suggestions listed below. Afterwards keep them handy for future reference.

Safety

- 1. Power Source** -- The unit should be connected to power supply only of the type described in the operating instructions or as marked on the unit.
- 2. Polarization** -- If the unit is equipped with a polarized AC power plug (a plug having one blade wider than the other), that plug will fit into the AC outlet only one way. This is a safety feature. If you are unable to insert the plug fully into the outlet, try reversing the plug. If the plug should still fail to fit, contact your electrician to replace your obsolete outlet. Do not defeat the safety purpose of the polarized plug.
- 3. Power Cord Protection** -- AC power supply cords should be routed so that they are not likely to be walked on or pinched by items placed upon or against them. Never take hold of the plug or cord if your hand is wet, and always grasp the plug body when connecting or disconnecting it.
- 4. Nonuse Periods** -- When the unit is not used, turn the power off. When left unused for a long period of time, the unit should be unplugged from the household AC outlet.

Installation

Environment

- 1. Water and Moisture** -- Do not use this unit near water—for example, near a bathtub, washbowl, swimming pool, or the like. Damp basements should also be avoided.
- 2. Condensation** -- Moisture may form on the lens in the following conditions...
 - immediately after a heater has been turned on.
 - in a steamy or very humid room.
 - when the unit is suddenly moved from a cold environment to a warm one.If moisture forms inside this unit, it may not operate properly. To correct this problem, turn on the power and wait about one hour for the moisture to evaporate.
- 3. Heat** -- The unit should be situated away from heat sources such as radiators and the like. It also should not be placed in temperatures less than 5° C (41° F) or greater than 35° C (95° F).

Placement

- 1. Ventilation** -- The unit should be situated so that its location or position does not interfere with its proper ventilation. Allow 10 cm (4") clearance from the rear of the unit.
- 2. Foreign Material** -- Care should be taken so that objects do not fall into and liquids are not spilled into the unit. Do not subject this unit to excessive smoke, dust, mechanical vibration, or shock.
- 3. Magnetism** -- The unit should be situated away from equipment or devices that generate strong magnetic fields.
- 4. Stacking** -- Do not place heavy objects, other than system components, on top of the unit.
- 5. Surface** -- Place the unit on a flat, level surface.

- 6. Carts and Stands** -- The unit should be used only with a cart or stand that is recommended by the manufacturer. The unit and cart combination should be moved with care. Quick stops, excessive force, and uneven surfaces may cause the unit and cart combination to overturn.



- 7. Wall or Ceiling Mounting** -- The unit should not be mounted to a wall or ceiling, unless specified in this operating instructions.

Maintenance

Clean the cabinet, panel and controls with a soft cloth lightly moistened with mild detergent solution.

Do not use any type of abrasive pad, scouring powder or solvent such as alcohol or benzene.

Service

- 1. Damage Requiring Service** -- The unit should be serviced by qualified service personnel when:
 - (a) The AC power supply cord or the plug has been damaged; or
 - (b) Objects have fallen or liquid has been spilled into the unit; or
 - (c) The unit has been exposed to rain; or
 - (d) The unit does not appear to operate normally or exhibits a marked change in performance; or
 - (e) The unit has been dropped, or the enclosure damaged.
- 2. Servicing** -- The user should not attempt to service the unit beyond that described in the operating instructions. All other servicing should be referred to an authorized service personnel.

For the address of an authorized servicenter:

In the U.S.A. 1-800-211-7262 or web site

(<http://www.panasonic.com>)

In Canada 905-624-5505 or web site

(www.panasonic.ca/fdbckca.htm)

Cautions on moving this unit

Before moving the changer to another location, be sure to remove all discs from the slots and turn off the changer.

Failure to do so will expose the compact discs and the changer to the risk of severe damage.

CAUTION

The changer mechanism automatically locks when power is turned off, to protect it against damage in transport. Therefore, always press [POWER] and make sure "OFF" appears on the display before you unplug the changer.

Other cautions

Outside light or noise may sometimes cause the changer to detect a disc when there isn't one. However, the changer always correctly detects the disc when in the play mode.

Do not leave the front panel open. Infiltrating dust or other matter may lead to damage or malfunctions.

Connections

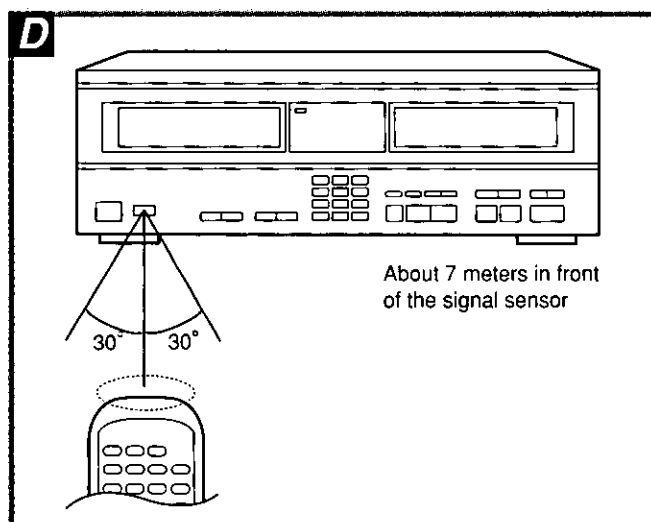
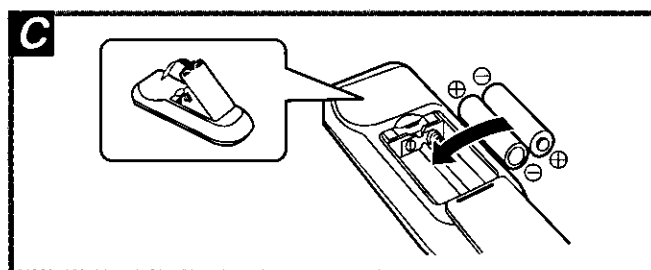
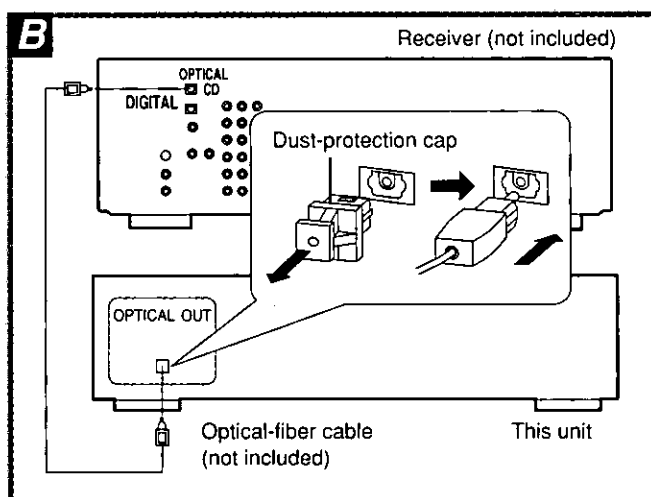
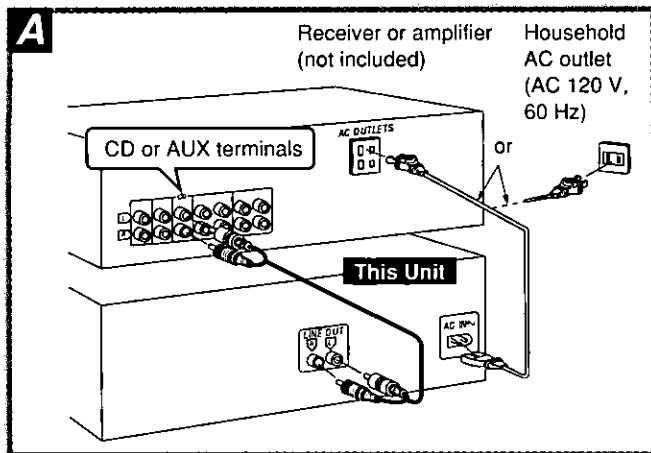

Note

- Set the changer on a flat, level surface.
- Before connecting the changer to your audio system, make sure that the power of the changer and all other system components is turned off. **A**

Stereo connection cable



Memory retention

The information and presetting you enter is retained in the unit's memory even if the unit is disconnected from the AC power source. The period of retention for each type of information is as follows:

- program play (⇒ page 10) and disc grouping play (⇒ page 14); approximately one week
- text editing (⇒ page 19); unlimited.

Digital connection **B**

Remove the dust cap and connect this unit to other digital equipment with an optical fiber terminal, such as a receiver or digital surround processor.

- Leave the cap attached when this terminal is not being used.

For your reference

If you have DTS format CDs, you can enjoy six channel playback by connecting this unit to a receiver or digital surround processor that has a DTS decoder.

- Note** Use only the optical fiber terminal when playing back DTS format discs. DTS signals can only be correctly output through the digital terminal. Connection through the stereo LINE OUT terminals will result in noise and could possibly damage your speakers.
- DTS is a trademark of Digital Theater Systems, L.P.

Preparing the remote control

Battery installation **C**

Check the (+) and (-) sides.

Use of batteries

- Do not mix old and new batteries, or batteries of different types (manganese and alkaline, etc.).
- Never subject batteries to excessive heat or flame; do not attempt to disassemble them; and be sure they are not short-circuited.
- If the remote control is not to be used for a long period of time, remove the batteries and store them in a cool, dark place.
- Do not attempt to recharge alkaline or manganese batteries.
- Do not use rechargeable type batteries.

When you need to replace these batteries

Use two R6/LR6, AA, UM-3 or equivalent batteries.

Correct method of use **D**

Operation notes

- Do not place obstacles between the remote control signal sensor and remote control unit.
- Do not expose the remote control signal sensor to direct sunlight or to the bright light of an inverter fluorescent light.
- Take care to keep the remote control signal sensor and end of the remote control unit free from dust.
- If this system is installed in a rack with glass doors, the glass doors' thickness or color might make it necessary to use the remote control a shorter distance from the system.

To prevent damage

- Never place heavy items on top of the unit.
- Do not disassemble or reconstruct the unit.
- Do not spill water or other liquids into the unit.

A

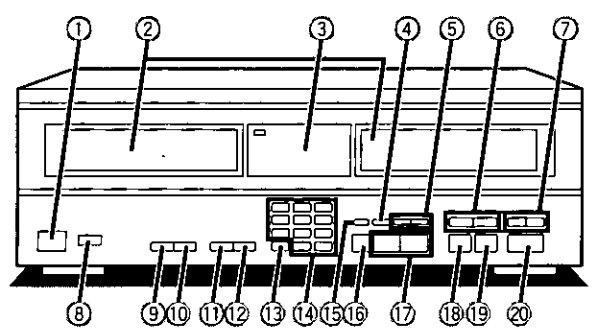

B

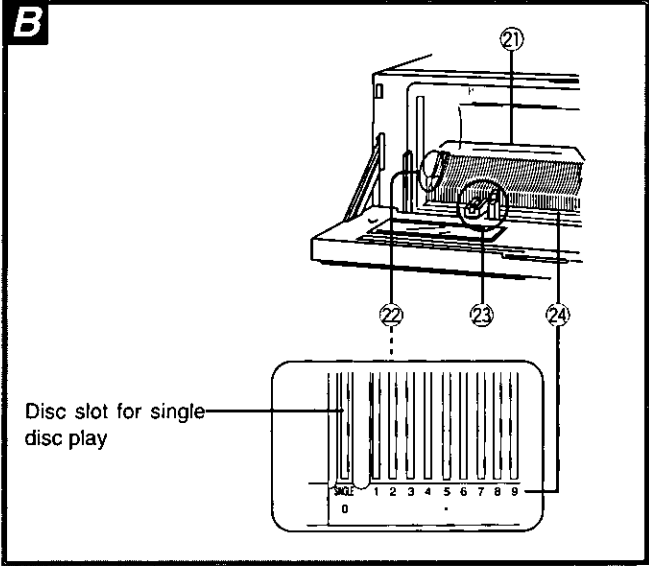

C

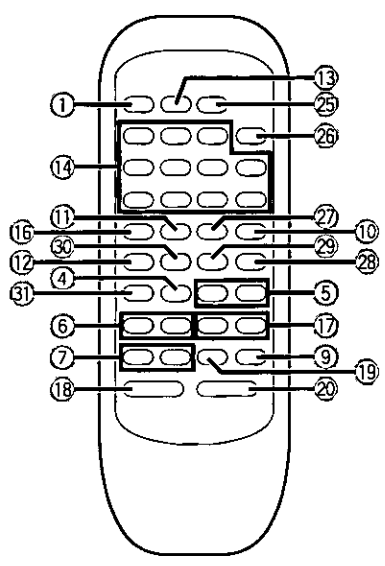

Controls

Main unit

- ① **Standby/on switch (⏻/⏻, POWER)**
Press to switch the unit from on to standby mode or vice versa. In standby mode, the unit is still consuming a small amount of power.
- ② **Windows**
- ③ **Display**
- ④ **Text mode button (TEXT MODE)**
- ⑤ **Text search buttons (∨, ∧, TEXT SEARCH)**
- ⑥ **Search/Text character select buttons (◀◀, ▶▶, SEARCH/CHARACTER)**
- ⑦ **Track skip/Text cursor buttons (◀◀, ▶▶, SKIP/CURSOR)**
- ⑧ **Remote control signal sensor**
- ⑨ **Single disc play button (SINGLE ▶)**
- ⑩ **ID scan button (ID SCAN)**
- ⑪ **Random mode button (RANDOM MODE)**
- ⑫ **Programming button (PROGRAM)**
- ⑬ **Disc/Caps button (DISC, CAPS)**
- ⑭ **Numeric buttons**
- ⑮ **Text edit button (TEXT EDIT)**
- ⑯ **Disc enter button (DISC ENTER)**
- ⑰ **Disc skip buttons (DISC SKIP, -, +)**
- ⑱ **Stop button (■)**
- ⑲ **Pause button (⏸)**
- ⑳ **Play button (▶)**

Disc slot section

For an explanation on how to open the front panel, see page 7 "How to set discs".

- ⑳ **Disc slots**
- ㉑ **Disc slot for single disc play (SINGLE)**
- ㉒ **Loader carriage**
- ㉓ **Slot numbers**

Remote control

Buttons ①, ④, ⑤, ⑨ to ⑫, and ⑰ to ⑳ have the same functions as the corresponding buttons on the main unit.

- ㉔ **Search button (◀◀ SEARCH ▶▶)**
- ㉕ **Track skip buttons (◀◀ SKIP ▶▶)**
- ㉖ **Disc selector button (DISC)**
- ㉗ **Numeric/group select buttons**
- ㉘ **Group button (GROUP)**
- ㉙ **Group enter button (GROUP ENTER)**
- ㉚ **Repeat button (REPEAT)**
- ㉛ **Direct programming button (DIRECT PROGRAM)**
- ㉜ **Recall button (RECALL)**
- ㉝ **Clear button (CLEAR)**
- ㉞ **Time mode button (TIME MODE)**

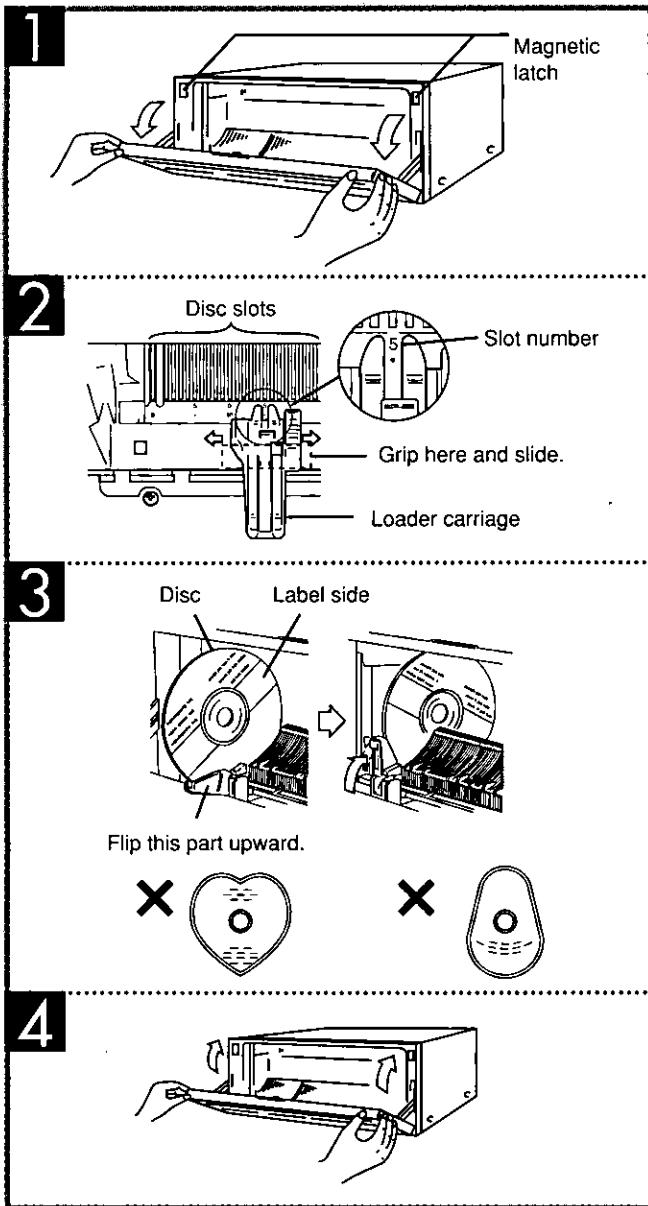
A

Setting/Removing discs

How to set discs

A

- 1 Pull gently on both ends to open the front panel.

Caution

- Unless setting or removing discs, keep hands out of the changer while open. You could injure yourself if you get entangled in the internal mechanism.
- Keep cassette tapes away from the magnetic latches.

- 2 Slide the loader carriage to the slot where the disc is to be inserted.

Note

Slot No. 0 (SINGLE) is reserved for single disc play. (→ page 9.)

- 3 Set the disc on the loader and flip the loader upwards.

Caution

- Do not use 3" (8 cm) discs fitted with expander rings. Expander rings could damage the disc slots.
- Do not use cleaning discs or warped discs. These could damage your changer.
- Do not use discs with poorly attached labels or stickers. Adhesive protruding from peeled off stickers can cause the changer to malfunction.
- Do not put anything other than discs in the changer.
- Do not use irregular shaped CDs (heart-shape, etc.).

- 4 Close the front panel gently.

Note

If you leave the front panel open while a disc is in play the changer will stop when the disc is finished.

How to remove discs

B

1. Open the front panel.
2. Slide the loader carriage to the slot you want.
3. Press the eject button on the loader carriage.

Special notes

You can set and remove discs while another disc is playing.

- Do not set a disc in the slot of the disc being played (slot flashes). The disc in play is returned to its slot when finished. If two discs somehow jam in a slot, they could be damaged. When this happens, the message "TAKE OUT" will appear on the display. Remove the disc that doesn't belong in the slot and press the stop button.
- Do not open the CD front panel and press the eject button when "CHECKING DISCS" appears in the display. The CD mechanism will be damaged if the eject button is pressed at this time.
- Sometimes the front panel cannot be opened while a disc is playing. In this case, wait until you can open it.

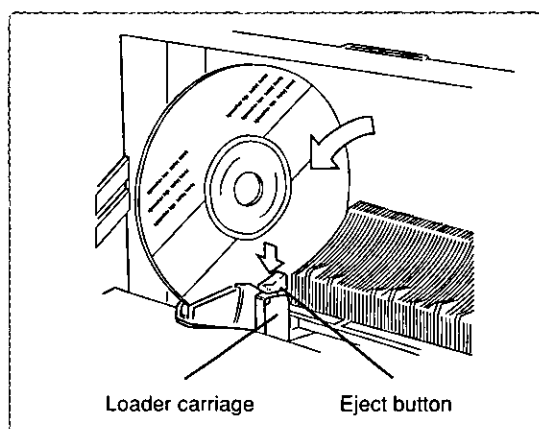
B

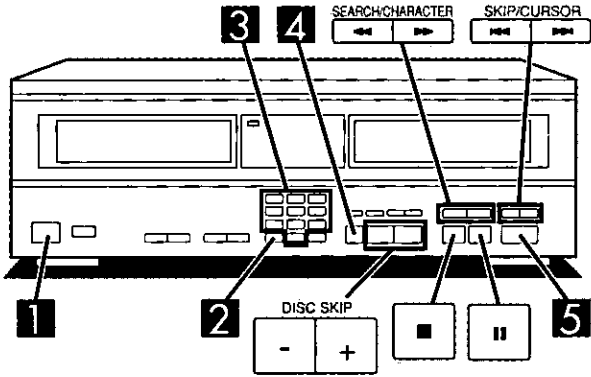

1

2

3

4

5

Sequential play

The changer plays all the tracks on all the discs in order and stops automatically when the last track on the last disc finishes playing.

Before starting, load your discs.
Perform steps 2 to 4 within 7 seconds of each other.

- 1 Press [POWER].**
The unit will switch on.
First, the message "CHECKING DISCS" will be displayed and then the number of the disc previously played. If it was a CD-TEXT disc then the name of the album will also be displayed (→ page 17).

Steps 2 and 3 are not necessary if you want to begin play from this disc.

- 2 Press [DISC/CAPS].**
- 3 Press the numeric button(s) to select the disc.**
To select a disc numbered over 10:
For example: "11"
[1] → [1]
For your reference
You can also select a disc with [DISC SKIP] (- or +) instead of doing steps 2 and 3.

- 4 Press [DISC ENTER].**
- 5 Press [▶].**
The changer plays all the loaded discs, from the selected disc, all the way through to the disc before it.
Text information will be displayed in place of the time if it is a CD-TEXT disc (→ page 17).

To stop play

Press [■].

The display showing the number of tracks and the total playing time is cleared if the front panel is opened.

To temporarily stop play

Press [⏸].

To search for a position

Press and hold either [◀] (backward) or [▶] (forward) during play. In program or random play modes, searching can only be done on the current track.

To skip tracks

Press either [◀] (backward) or [▶] (forward) during play. In program play, skipping goes in the programmed order.

Note

You cannot skip backwards in random mode.

To skip discs

Press either [-] (backward) or [+] (forward) either while a disc is playing or stopped.

Note

This does not work during full disc random play mode or program play.

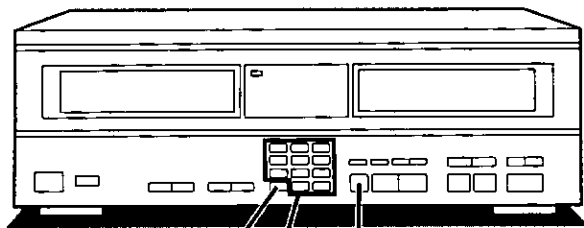
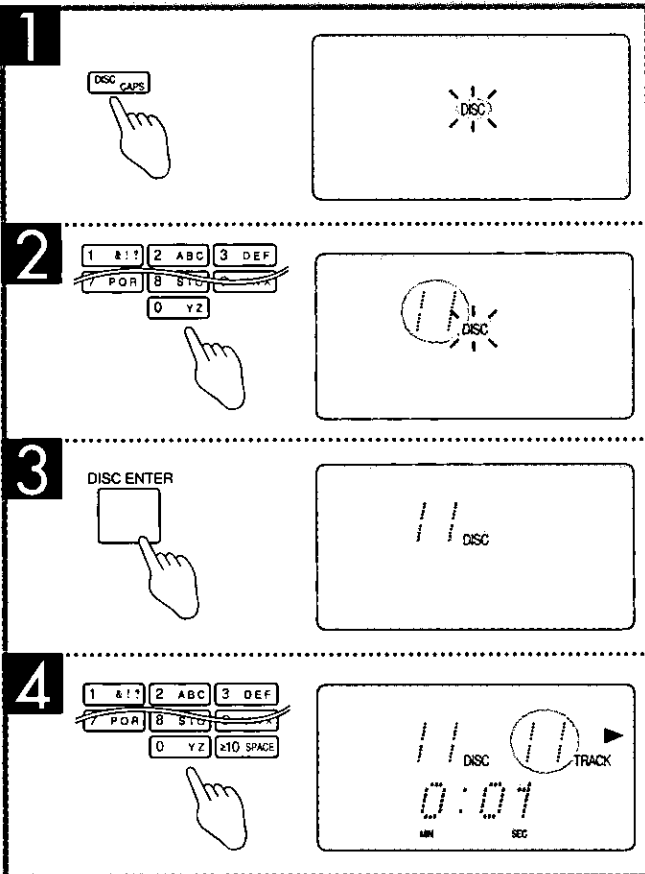
A**1 2 4 3****Direct play**

You can start play from the disc and track of your choice. Perform steps 1 to 3 within 7 seconds of each other.

- 1** Press [DISC/CAPS].
- 2** Press the numeric button(s) to select the disc.
(→ step 3 on page 8)
- 3** Press [DISC ENTER].
- 4** Press the numeric button(s) to select the track.
Play starts at the selected track and continues through to the end of that CD.
To select a track numbered higher than 10:
For example: "11"
≥10 → 1 → 1

Single disc play

Single disc play is a convenient way of playing back a specific disc, one you just bought, for example, without having to go through the usual selection procedure.

- 1** Set a disc in slot No. 0.
- 2** Press [SINGLE ▶].
The changer plays all the tracks on the disc in slot 0 and then stops automatically.

Note

Single disc play is canceled if you skip discs.

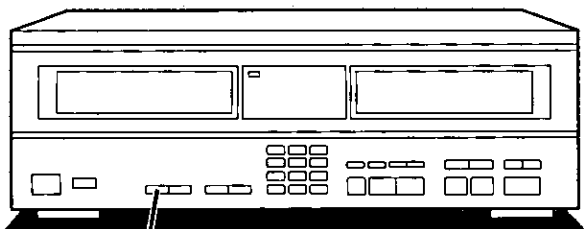
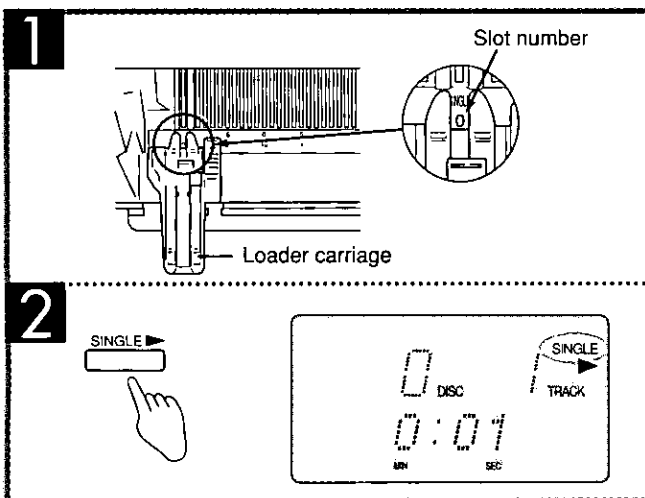
B**2**

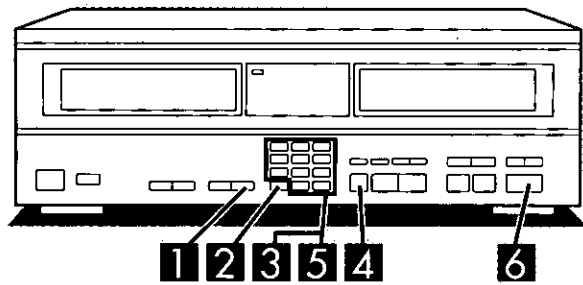

1		
2		
3		
4		
5		
6		

A

--	--

Program play

Program play lets you playback your favorite tracks in the sequence you want to hear them. The program can hold up to 32 items. Perform steps 2 to 4 within 7 seconds of each other.

[In the stop mode]

- 1** Press [PROGRAM].
- 2** Press [DISC/CAPS].
- 3** Press the numeric button(s) to select the disc(s).
- 4** Press [DISC ENTER].
The "AL" indication shows that all the tracks on the disc are selected.

To program disc numbers only, repeat steps 2-4. Slot No. 0 can also be programmed.
- 5** Press the numeric button(s) to select the track.

Repeat this step if you want to enter tracks from the same disc.

Repeat steps 2-5 until you have completed all entries.

Note

- PGM FULL is displayed if you try to enter a 33rd item.
- Empty slots and track numbers that don't exist on the discs can be programmed but clear when play starts.

- 6** Press [▶].
The changer plays the tracks in the programmed order and then stops automatically.

To enter additional selections during play, repeat steps 2-5.

Direct programming

(Only available from the remote control.)

This function allows you to add a track to your program while listening to it.

[While the track you want to program is playing]

Press [DIRECT PROGRAM].

When you make a program as explained under "Program play" above, and then perform this procedure without clearing the program first, the selected track is added to the end of the program. To listen to programmed tracks, press [PROGRAM] and check "PROGRAM" appears on the display, then press [▶].

Note

- If you press [DIRECT PROGRAM] and there are already 32 items in the program, "PGM FULL" is displayed and the track cannot be added.
- During program play, [DIRECT PROGRAM] does not respond to touch.

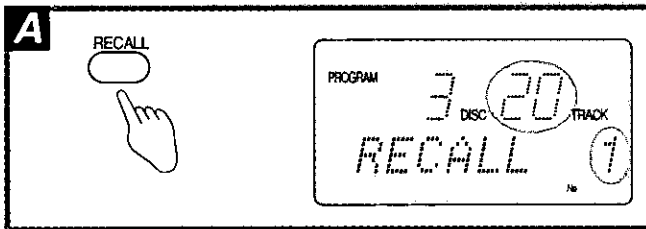
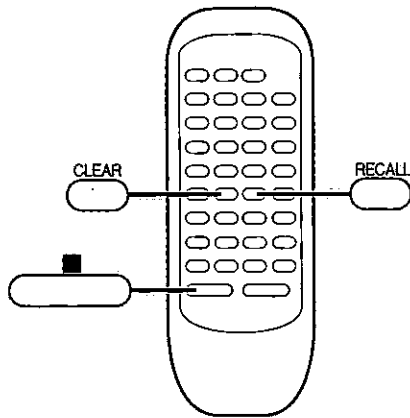

Program play

To check programmed contents

(Only available from the remote control.)

Press [RECALL].

The programmed tracks are displayed in order each time it is pressed.

To clear programmed contents

(Only available from the remote control.)

[In the stop mode]

To clear a specific item from the program

Press recall until the item is displayed, then press [CLEAR].

To clear the last item on the program

Press [CLEAR].

To clear the entire contents of the program

Press .

To cancel the program mode

[In the stop mode]

Press [PROGRAM].

The [PROGRAM] indicator goes out.

The contents of the program are stored in the memory.

To replay your program

1. Press [PROGRAM].
2. Press .

Special note on recording programs

The changer needs time to change the discs and find the tracks. Consequently, it will take the changer slightly longer than the total track time to record everything. Exactly how much longer depends on the contents of the program.

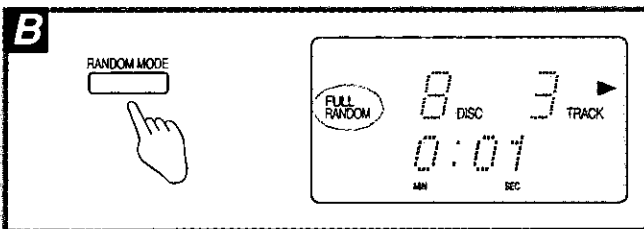
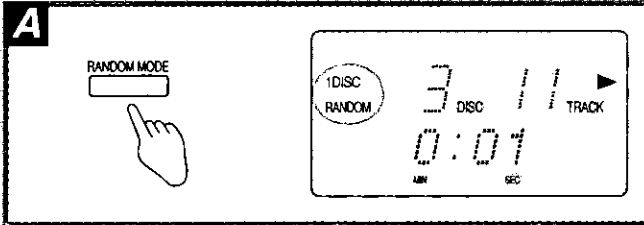
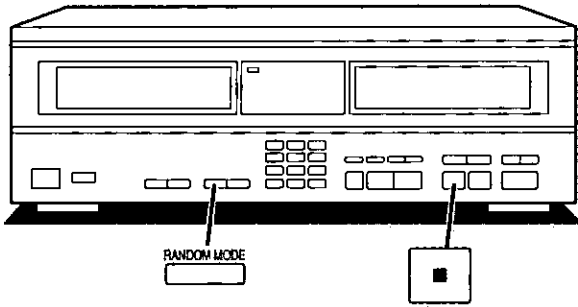

Random play

The tracks will be played in random order. There are two types of random play as described below.

One disc random play A

The changer will play all tracks on the current disc in random order. Then, it will choose a new disc randomly, excluding the discs already played, and play all tracks on that disc in random order.

[In the stop or play mode]

Press [RANDOM MODE] to select "1 DISC RANDOM".

Each time the button is pressed
 1 DISC RANDOM → FULL RANDOM → (Off)

For your reference

In the single disc play mode

Only tracks from the disc in slot No. 0 are played in random order.

In the disc grouping play mode. (→ page 14.)

The discs in the chosen group are played as in one disc random play above.

Full random play B

Tracks are played in random order from amongst all the tracks on all the loaded discs. In this mode, it is possible that a track will be played twice, or not played at all.
 (A maximum of 250 tracks are played.)

[In the stop or play mode]

Press [RANDOM MODE] to select "FULL RANDOM".

Each time the button is pressed
 1 DISC RANDOM → FULL RANDOM → (Off)

Note

The disc in slot No. 0 will not be played.

In the disc grouping play mode. (→ page 14.)

The discs in the chosen group are played as in full random play above.

To cancel random play mode

Press [■].

The "1 DISC (or FULL) RANDOM" indicator will go out.

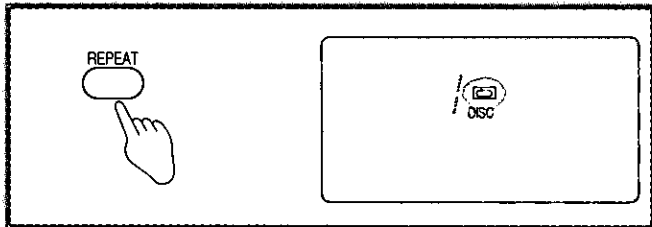
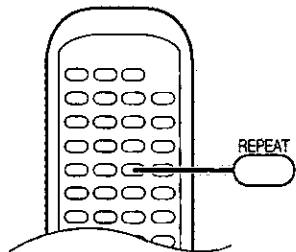
A

Repeat function

(Only available from the remote control.)
This repeats play in the chosen mode.

[Before or during play]
Press [REPEAT].

.....
To cancel repeat mode
Press [REPEAT].

To repeat a track or set of tracks

1. Program the track or tracks (➔ page 10).
2. Press [REPEAT] so "DISC" is displayed.
3. Press [▶].

For your reference

In random mode, the order is different each time the process is repeated.

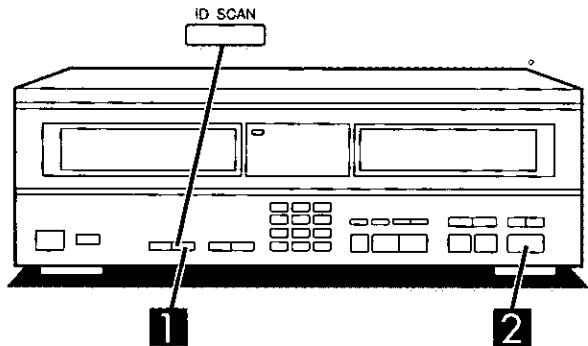
B

ID scan function

This function helps you find a particular track. It searches through the tracks and then plays a 10 second piece of each track around the loudest part of the track.

1 Press [ID SCAN].
ID scan will start.

[When the desired track has been found]

2 Press [▶].
The changer will play the track from the beginning.

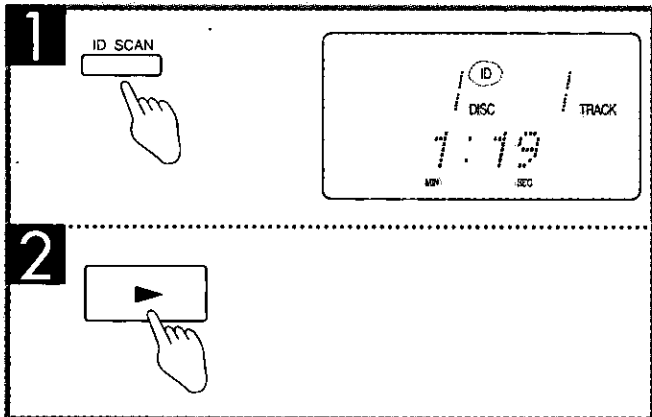

.....
To cancel ID scan

Press [ID SCAN].
The "ID" indicator will go out.
The changer will continue to play from the track being played.

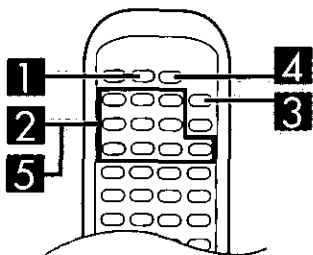

1		
2		
3		
4		
5		

Disc grouping play

(Only available from the remote control.)

You can put discs into 5 groups (A–E). You can then play the discs in those groups.

- Each disc can belong to more than one group.
- [SL-MC7] Each group can include up to 110 discs.
- [SL-MC4] Each group can include up to 60 discs.
- Each group can be named.

To make groups

Perform steps 1 to 5 within 7 seconds of each other.

You cannot select slot No. 0.

[During sequential play or while it is on stopped]

- 1 Press [DISC].**
- 2 Press the numeric button(s) to select the disc.**
To select a disc numbered over 10
For example: "19"
[1] → [9]
- 3 Press [GROUP ENTER].**
If the disc is already registered in a group, the group's letter lights up.
- 4 Press [GROUP].**
- 5 Press the numeric button corresponding to the group (A, B, C, D or E).**
The disc chosen in step 2 is registered into the selected group.

Repeat steps 1–5 to register other groups.

To check what discs are in what groups

(While stopped)

1. Press [GROUP].
2. Press the numeric button corresponding to the group.
3. Press [■].
4. Press [DISC SKIP] (– or +).
The numbers of the discs in the group will be displayed each time the buttons are pressed.

Disc grouping play

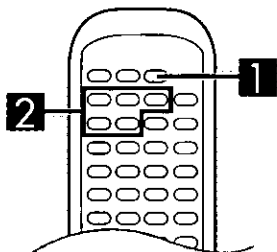

To cancel discs from groups

1. Press [DISC].
2. Select the disc you want to clear with the numeric buttons.
3. Press [GROUP ENTER].
4. Press [GROUP].
5. Press the numeric button corresponding to the group.
The selected group indication on the display will go out.

For your reference

If the disc is registered in more than one group, you can cancel it from all groups in a single operation by pressing [■] in step 4 (in the stop mode).

Playing back discs in a group

[While stopped or during sequential play]

First, follow the steps on the previous page to register the groups.

- 1 Press [GROUP].
- 2 Press the numeric button corresponding to the group.

To cancel disc grouping play mode

[While the changer is stopped.]

Press [GROUP] and then the numeric button corresponding to the group shown on the display.

Note

- The name of the group is shown if it has been named (→ page 16).
- If you press the group button of a group which has no discs registered in it, the message "NO INPUT" will appear on the display.

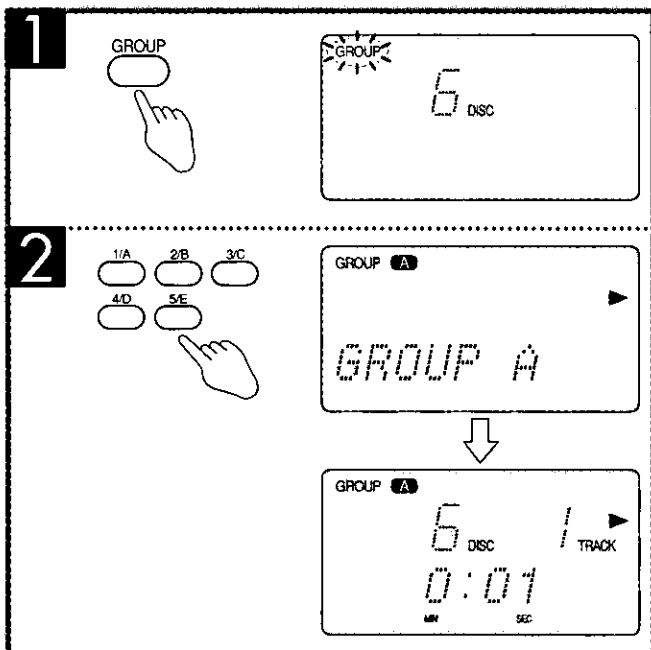

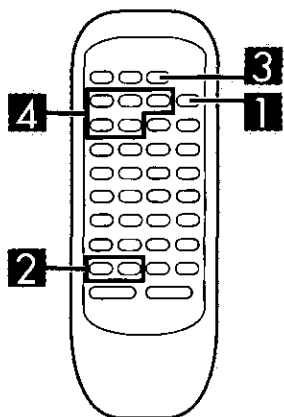

1 Press [GROUP ENTER].

2 Press [SKIP] (◀◀ or ▶▶) to select the name.

3 Press [GROUP].

4 Press the numeric button corresponding to the group you want to name.

Disc grouping play

To name groups

You can name your groups. The changer has several preset names to choose from.

[During sequential play or while stopped]

- 1** Press [GROUP ENTER].
- 2** Press [SKIP] (◀◀ or ▶▶) to select the name. The pre-entered names will appear in the following order when the buttons are pushed.

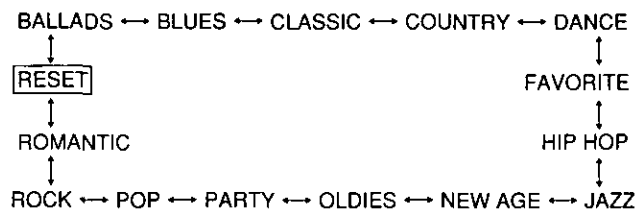

- 3** Press [GROUP].
- 4** Press the numeric button corresponding to the group you want to name.

Repeat steps 1–4 to name the other groups.

To cancel names

1. Press [GROUP ENTER].
2. Select "RESET" in step 2.
3. Press [GROUP].
4. Select the group name you want to clear. It will now be shown as "GROUP A...E".

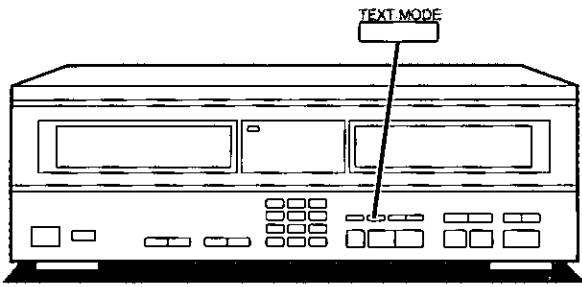

CD-TEXT function

This function shows the title of the CD, the name of the artist, or the song title. There are discs with this information already stored on them, called CD-TEXT discs, but this function also works with ordinary discs.

Note

- The information on CD-TEXT discs is automatically read when they begin playing. The title of the CD and the artist name must be entered manually for ordinary discs. Enter this information before doing the following (→ page 19).
- Song titles cannot be displayed with ordinary discs.

Displaying a CD's information

Press [TEXT MODE].

The display is changed in the following order:

In the stop mode

ALBUM (Album title) → ARTIST (Artist name) → Total playing time

In the play mode

SONG → ALBUM → ARTIST → time display
(Song title) (Album title) (Artist name)

Song titles are displayed whenever a track is changed, even if the time display is chosen.

Note

- Up to 32 characters of text information can be displayed while the changer is stopped. The entire text is displayed during playback, even if it is longer than 32 characters.
- Song titles are not displayed after a certain number of tracks if there are many tracks on the disc or if titles are exceptionally long.
- Text information is attached to the slot. Any information entered into memory will be displayed for that slot until another CD-TEXT disc is played in that slot or the information is entered manually (→ page 19).
- Some CD-TEXT discs do not have information about the artist or track. Nothing is displayed if this is the case.
- Only one artist name per disc is displayed. It will be the name of the main artist on the disc and does not change with each track.

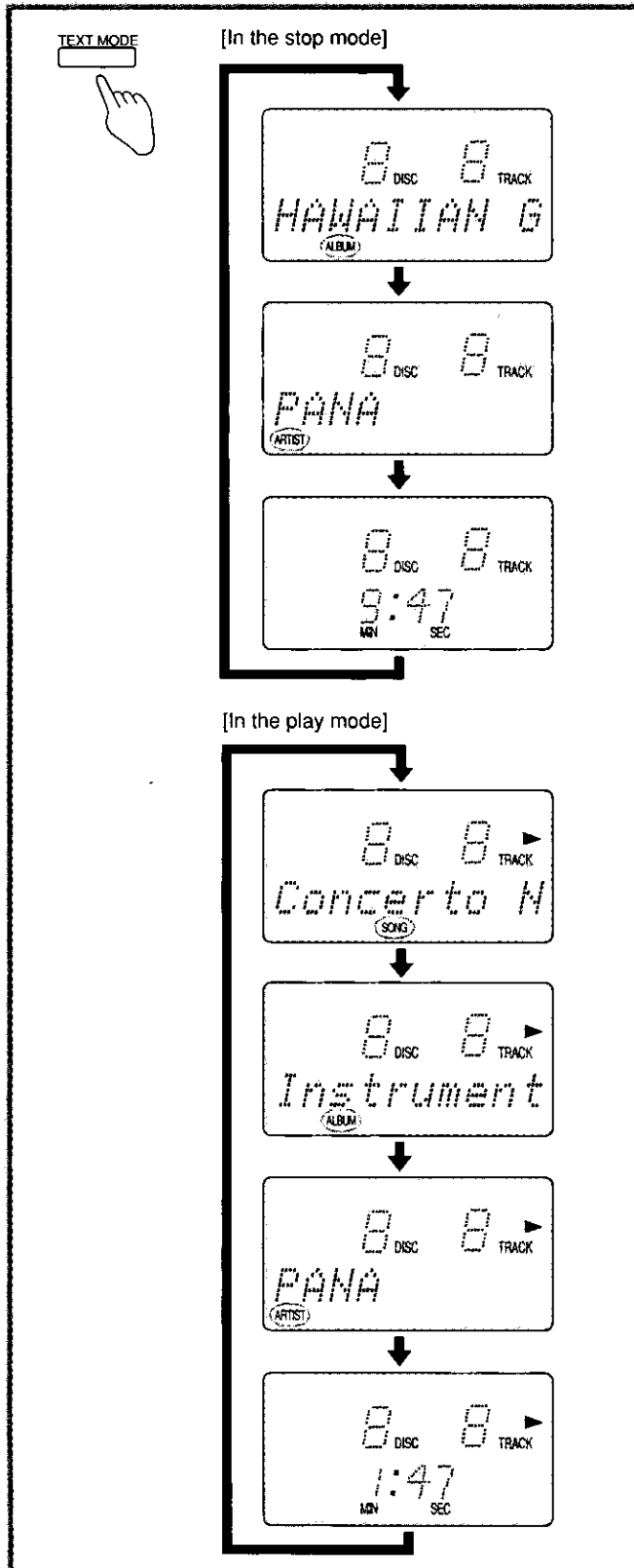

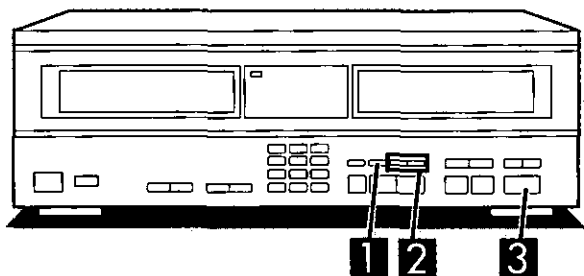

A

1 **TEXT MODE**

2 **TEXT SEARCH**

3

B

1 **TEXT MODE**

2 **TEXT SEARCH**

3

CD-TEXT function

To search discs or tracks using text information (TEXT SEARCH)

There are 3 search modes: album title, artist name or song title.

Note

You cannot text search in program play/random play/ID scan mode.

To find a specific CD (Album search/Artist search)

- 1** Press [TEXT MODE] to select "ALBUM" or "ARTIST".
- 2** Press [TEXT SEARCH] (V or ^) to select the disc.
 V: Changes in reverse alphabetical order.
 ^: Changes in alphabetical order.
- 3** Press [▶].
 The changer will start playing the selected disc.

For your reference

- In the disc grouping play mode, the search is limited to the selected group.
- A text search can be performed while a disc is playing. In this case, the display will not show the information about the disc currently playing.

To find a specific song (Song search)

This function only works with CD-TEXT discs that have song information on them.

[During play]

- 1** Press [TEXT MODE] to select "SONG".
- 2** Press [TEXT SEARCH] (V or ^) to select the track.
- 3** Press [▶].
 Play begins at the selected track and then continues through to the last track on the disc before.

CD-TEXT function

Entering CD information manually (TEXT EDIT)

32 characters worth of text information can be entered each for the album name and artist name. This can be done for each disc loaded in the changer.

Note

- The information entered for the CD is attached to the slot. If the CD is moved to another slot, the information will not be displayed.
- The information on CD-TEXT discs takes preference over manually entered information, so any information entered will be cleared once a CD-TEXT disc is played in a slot.

Perform steps 1 to 3 within 7 seconds of each other.

[while stopped]

- 1 Press [DISC/CAPS].**
- 2 Select a disc with the numeric buttons.**
- 3 Press [DISC ENTER].**
- 4 Press [TEXT MODE] to select "ALBUM" or "ARTIST".**
- 5 Press [TEXT EDIT].**
The display is now ready for text to be entered.
- 6 Press [DISC/CAPS] to select the input mode.**
The display changes as follows every time the button is pressed.
A (CAPITALS) → a (lower case) → 1 (numerals)
- 7 Press the numeric buttons to enter the text.**
To continue entering characters with the same numeric button, press [SKIP/CURSOR] (▶▶).
The character is entered if a different numeric button or [SKIP/CURSOR] (▶▶) is pressed, and the cursor moves to the next position.
Repeat steps 6 and 7 to enter more characters.

numeric button	Characters, symbols, and functions		
1	!	"	# \$ % & ' () * + , - . / : ;
	< = > ? @ [\] ^ _ { } ~	▣	▤
	ı ç £ ¤ ¥ ¦ § ¨ © ª « ¬ ® ¯ ° ±		
	² ³ ´ µ ¶ · ¸ ¹ º » ¼ ½ ¾ ¿	À Á Â Ã	
	Ä Å Æ Ç È É Ê Ë Ì Í Î Ï Ñ Ò Ó	Ô Õ Ö × Ø Ù Ú Û Ü Ý Þ ß à á â ã	
ä å æ ç è é ê ë ì í î ï ð ñ ò ó ô	õ ÷ ø ù ú û ü ý þ ÿ		
2	A	B	C
3	D	E	F
4	G	H	I
5	J	K	L
6	M	N	O
7	P	Q	R
8	S	T	U
9	V	W	X
0	Y	Z	
≥10	SPACE		

In the numeral mode, the numeral corresponding to the numeric button is entered. In the other modes, the character displayed changes in the order shown in the chart each time the numeric button is pressed.

(Continued on next page)

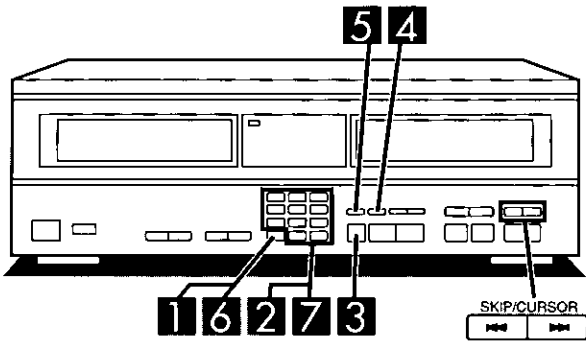

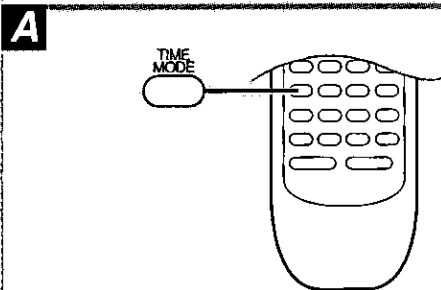
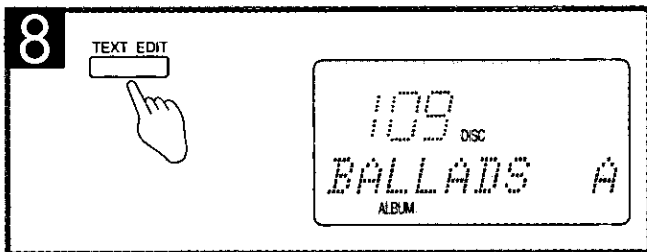
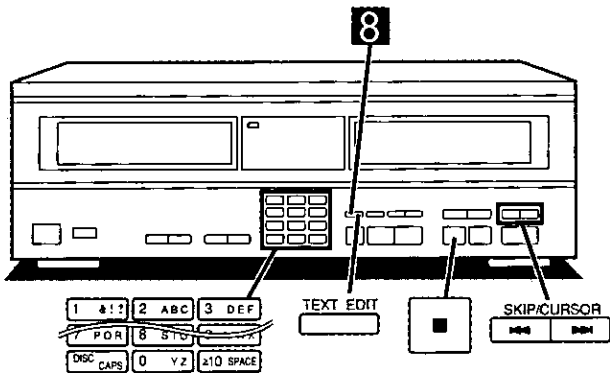

TIME MODE

① Track number and elapsed play time of the current track

② Total remaining time on the disc

③ Track number and remaining time of the current track

④ Total elapsed play time on the disc

CD-TEXT function

8 Press [TEXT EDIT].

The text you entered is confirmed and displayed.

Canceling the text editing mode

The information entered can be cleared at any time before step 8.

Press [■].

Note

Letters and symbols appearing on the display may vary slightly from the printed listing.

Changing information you have entered

1. Display the information you want to change.
2. Press [TEXT EDIT].
3. Move the cursor to the character you want to change with [SKIP/CURSOR] (◀◀ or ▶▶).
4. Enter the new character with the numeric buttons.
5. Press [TEXT EDIT].

Clearing information you have entered

1. Display the information you want to change.
2. Press [TEXT EDIT].
3. Press [CLEAR] on the remote control.
4. Press [TEXT EDIT].

Time mode selection

(Only available from the remote control.)

You can see various information about the time on the disc you are playing.

[In the play or pause mode]

Press [TIME MODE].

The display changes in the order shown in the diagram.

In all play modes

When track number 21 or greater is playing, display ③ shows "----". ① is displayed if play is stopped and then started again.

In the program/random play mode

The displayed information will alternate between displays ① and ③ each time the button is pressed.

Time information remains displayed in the text information display area as long as the unit is in time mode.

A note on compact discs

This unit can only play discs with these marks.

However, do not use irregular shaped CDs (heart-shape, etc.). CDs of this sort can damage the unit. (A)

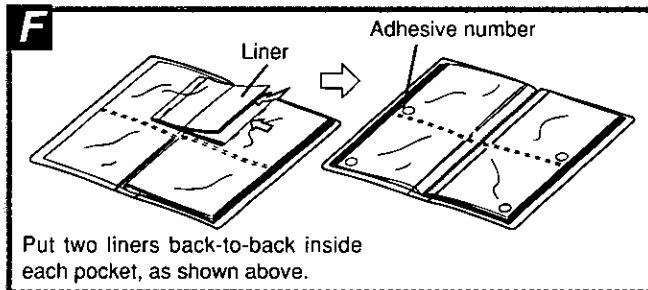
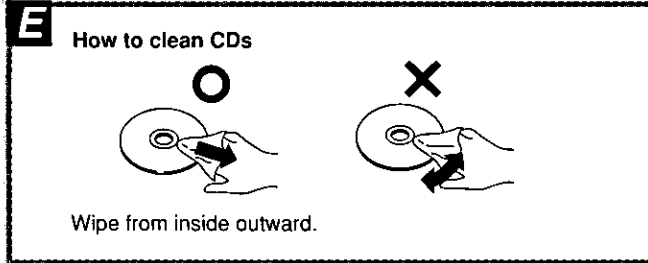
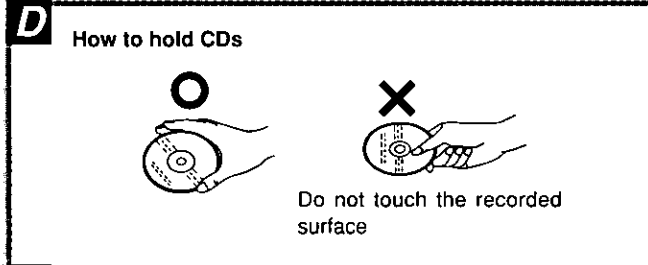
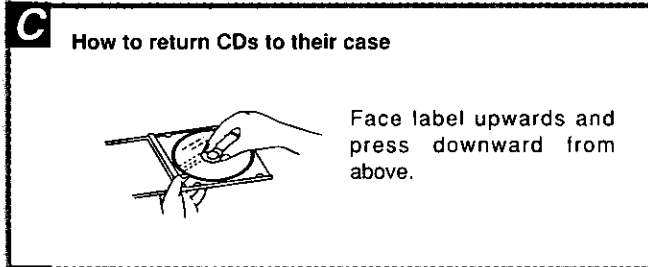
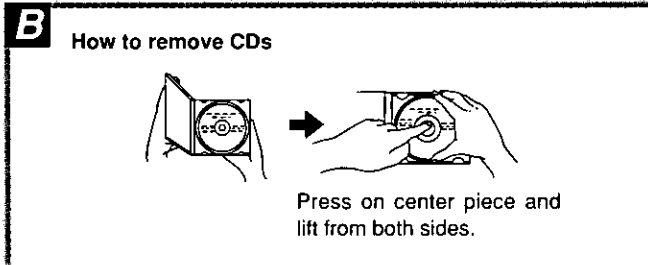
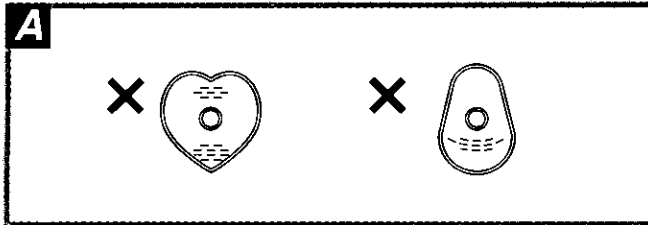

Handling precautions

Handle CDs as shown on the left (B-E).

- If you are taking the disc from a cold to a warm environment, moisture may form on the disc. Wipe this off with a soft, dry, lint-free cloth before using the disc.
- Do not write on the label side with a ball-point pen or other writing instrument.
- Do not use record cleaning sprays, benzene, thinner, static electricity prevention liquids or any other solvent.
- Do not use discs with poorly attached labels or stickers. Adhesive protruding from peeled off stickers can cause the changer to malfunction.

Storage precautions

Be sure to store discs in their cases to protect them from dust, scratches, and warping.

Do not place or store discs in the following places:

- Locations exposed to direct sunlight
- Humid or dusty locations
- Locations directly exposed to a heat vent or heating appliance
- In the glove compartment or on the rear deck of an automobile

The liner notes organizer

Your changer comes with a notebook-like binder (liner notes organizer) in which you can keep your CD liners. There are also numbered stickers to indicate slot numbers in the binder. This is a convenient way to keep track of what disc is in what slot.

Troubleshooting guide

Before requesting service for this unit, check the chart below for a possible cause of the problem you are experiencing. Some simple checks or a minor adjustment on your part may eliminate the problem and restore proper operation.

If you are in doubt about some of the check points, or if the remedies indicated in the chart do not solve the problem, refer to the directory of Authorized Service Centers (enclosed with this unit) to locate a convenient service center, or consult your dealer for instructions.

For detailed instructions, contact an authorized servicenter in the U.S.A. and Panasonic Canada Inc. Customer Care Centre in Canada.

In the U.S.A. 1-800-211-7262 or web site (<http://www.panasonic.com>)

In Canada 905-624-5505 or web site (www.panasonic.ca/faq.html)

Reference pages indicated in black circles. (For example: ⑦)

Problem	Probable cause(s)	Suggested remedy
Changer will not play.	A disc(s) or other foreign object(s) has fallen inside the changer.	• Open the front panel and remove the object.
	Moisture has collected in the changer.	• Allow the changer to dry out for about one hour before using it.
The disc in the changer does not play.	The disc label is facing left.	• Set the disc with the label facing right. (⑦)
	The disc is dirty.	• Wipe the disc with a soft cloth. (②)
	The disc is scratched.	• Replace the disc with a new one.
	The disc is warped.	
	The disc is not within specified standards.	
Play stops before changing to the next disc.	The front panel is open.	• Close the panel.
A certain music passage can't be played correctly.	The disc is dirty.	• Wipe the disc with a soft cloth. (②)
	The disc is scratched.	• Replace the disc with a new one.
There is noise from the tuner or disturbance on the TV screen.	Caused by high-frequency signals from this changer.	• Use the changer further away from the tuner or TV. • If the tuner or TV's antenna is the indoor type, use an outdoor one.
The error message "NO PGM" appears on the display, when program play is started.	Play was started without a track being programmed.	• Program a track. (⑩)
The error message "ERROR" appears on the display, and the changer stops operating.	The mechanism of the changer has been improperly adjusted.	• Turn the unit off and then back on again.
The error message "F-26" appears on the display and the changer stops operating.	The servo LSI has malfunctioned.	• Unplug the changer from its outlet, replug it in and turn the changer ON again.
The error message "TAKE OUT" appears on the display and the changer stops operating.	A disc has been put in the slot of the disc in play.	• Remove the disc whose number is displayed and press the stop button.
	Because of light or noise, the changer has detected a disc in the slot of the disc being played, even though it is empty.	• Check whether there is a disc in the displayed slot. With the front panel closed, hold down [■] for at least 4 seconds.
The changer does not respond correctly to remote commands.	The batteries have run out.	• Replace batteries with new ones.
	There is an obstruction between the remote control and the changer.	• Remove the obstruction.
	The batteries are inserted incorrectly. [The (+) and (-) polarities are reversed.]	• Reinsert batteries so that the polarities are correct.

Maintenance

If the surfaces are dirty

To clean this unit, wipe with a soft, dry cloth.

If the surfaces are extremely dirty, use a soft cloth dipped in a soap-and-water solution or a weak detergent solution.

- Never use alcohol, paint thinner or benzine to clean this unit.
- Before using chemically impregnated cloth, read the instructions that came with the cloth carefully.

Product service

Do not attempt to remove the cover(s) or repair the unit yourself.
Refer servicing to qualified personnel only.

Product information

For product service, product information or assistance in product operation, refer to the servicenter directory.

Having your unit serviced

Before bringing in your changer for service, be sure to remove all discs.

If the disc in play doesn't return to its slot when you press [■], hold the button down for about 4 seconds. The disc should return to the slot.

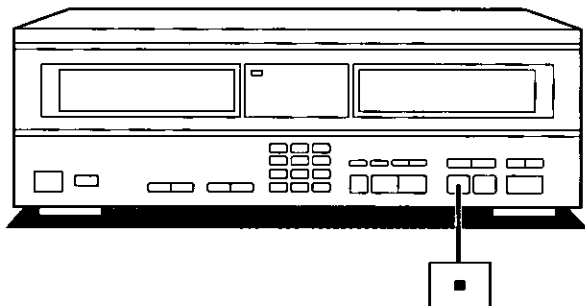

Technical specifications

AUDIO

No. of channels	2 (left and right, stereo)
Frequency response	2–20,000 Hz, ±1 dB
Output voltage	2 V (at 0 dB)
Dynamic range	92 dB
S/N	100 dB
Harmonic distortion	0.007% (1 kHz, 0 dB)
Wow and flutter	Below measurable limit
DA converter	MASH (1 bit)
Output impedance	Approx. 1 kΩ
Load impedance	More than 10 kΩ

PICKUP

Wavelength	780 nm
------------	--------

GENERAL

Power supply	AC 120 V, 60 Hz
Power consumption	11 W
Dimensions (W×H×D)	430×171×392 mm (16-15/16"×6-11/16"×15-7/16")
Weight	[SL-MC7] 7.1 kg (15.6 lb.) [SL-MC4] 6.4 kg (14.1 lb.)

Note: Specifications are subject to change without notice.
Weight and dimensions are approximate.

Disc index

Fill in the index to remind yourself which slots and groups you have put your CDs in.

No	GROUP					DISC NAME
0	SINGLE					
1	A	B	C	D	E	
2	A	B	C	D	E	
3	A	B	C	D	E	
4	A	B	C	D	E	
5	A	B	C	D	E	
6	A	B	C	D	E	
7	A	B	C	D	E	
8	A	B	C	D	E	
9	A	B	C	D	E	
10	A	B	C	D	E	
11	A	B	C	D	E	
12	A	B	C	D	E	
13	A	B	C	D	E	
14	A	B	C	D	E	
15	A	B	C	D	E	
16	A	B	C	D	E	
17	A	B	C	D	E	
18	A	B	C	D	E	
19	A	B	C	D	E	
20	A	B	C	D	E	
21	A	B	C	D	E	
22	A	B	C	D	E	
23	A	B	C	D	E	
24	A	B	C	D	E	
25	A	B	C	D	E	
26	A	B	C	D	E	
27	A	B	C	D	E	
28	A	B	C	D	E	
29	A	B	C	D	E	
30	A	B	C	D	E	
31	A	B	C	D	E	
32	A	B	C	D	E	
33	A	B	C	D	E	
34	A	B	C	D	E	
35	A	B	C	D	E	
36	A	B	C	D	E	
37	A	B	C	D	E	
38	A	B	C	D	E	
39	A	B	C	D	E	
40	A	B	C	D	E	
41	A	B	C	D	E	
42	A	B	C	D	E	
43	A	B	C	D	E	
44	A	B	C	D	E	
45	A	B	C	D	E	
46	A	B	C	D	E	
47	A	B	C	D	E	
48	A	B	C	D	E	
49	A	B	C	D	E	
50	A	B	C	D	E	
51	A	B	C	D	E	
52	A	B	C	D	E	
53	A	B	C	D	E	
54	A	B	C	D	E	
55	A	B	C	D	E	

No	GROUP					DISC NAME
56	A	B	C	D	E	
57	A	B	C	D	E	
58	A	B	C	D	E	
59	A	B	C	D	E	
60	A	B	C	D	E	
61	A	B	C	D	E	
62	A	B	C	D	E	
63	A	B	C	D	E	
64	A	B	C	D	E	
65	A	B	C	D	E	
66	A	B	C	D	E	
67	A	B	C	D	E	
68	A	B	C	D	E	
69	A	B	C	D	E	
70	A	B	C	D	E	
71	A	B	C	D	E	
72	A	B	C	D	E	
73	A	B	C	D	E	
74	A	B	C	D	E	
75	A	B	C	D	E	
76	A	B	C	D	E	
77	A	B	C	D	E	
78	A	B	C	D	E	
79	A	B	C	D	E	
80	A	B	C	D	E	
81	A	B	C	D	E	
82	A	B	C	D	E	
83	A	B	C	D	E	
84	A	B	C	D	E	
85	A	B	C	D	E	
86	A	B	C	D	E	
87	A	B	C	D	E	
88	A	B	C	D	E	
89	A	B	C	D	E	
90	A	B	C	D	E	
91	A	B	C	D	E	
92	A	B	C	D	E	
93	A	B	C	D	E	
94	A	B	C	D	E	
95	A	B	C	D	E	
96	A	B	C	D	E	
97	A	B	C	D	E	
98	A	B	C	D	E	
99	A	B	C	D	E	
100	A	B	C	D	E	
101	A	B	C	D	E	
102	A	B	C	D	E	
103	A	B	C	D	E	
104	A	B	C	D	E	
105	A	B	C	D	E	
106	A	B	C	D	E	
107	A	B	C	D	E	
108	A	B	C	D	E	
109	A	B	C	D	E	
110	A	B	C	D	E	

Write your group names here.

GROUP	GROUP NAME
A	
B	
C	
D	
E	

Panasonic Consumer Electronics Company, Division of Matsushita Electric Corporation of America
 One Panasonic Way Secaucus, New Jersey 07094
<http://www.panasonic.com>

Panasonic Sales Company, Division of Matsushita Electric of Puerto Rico, Inc. ("PSC")
 Ave. 65 de Infantería. Km. 9.5 San Gabriel Industrial Park, Carolina, Puerto Rico 00985

Panasonic Canada Inc.
 5770 Ambler Drive, Mississauga, Ontario L4W 2T3
www.panasonic.ca



RQT4941-P

H1298P0

Free Manuals Download Website

<http://myh66.com>

<http://usermanuals.us>

<http://www.somanuals.com>

<http://www.4manuals.cc>

<http://www.manual-lib.com>

<http://www.404manual.com>

<http://www.luxmanual.com>

<http://aubethermostatmanual.com>

Golf course search by state

<http://golfingnear.com>

Email search by domain

<http://emailbydomain.com>

Auto manuals search

<http://auto.somanuals.com>

TV manuals search

<http://tv.somanuals.com>