

Technika

EXCLUSIVELY FROM **TESCO**

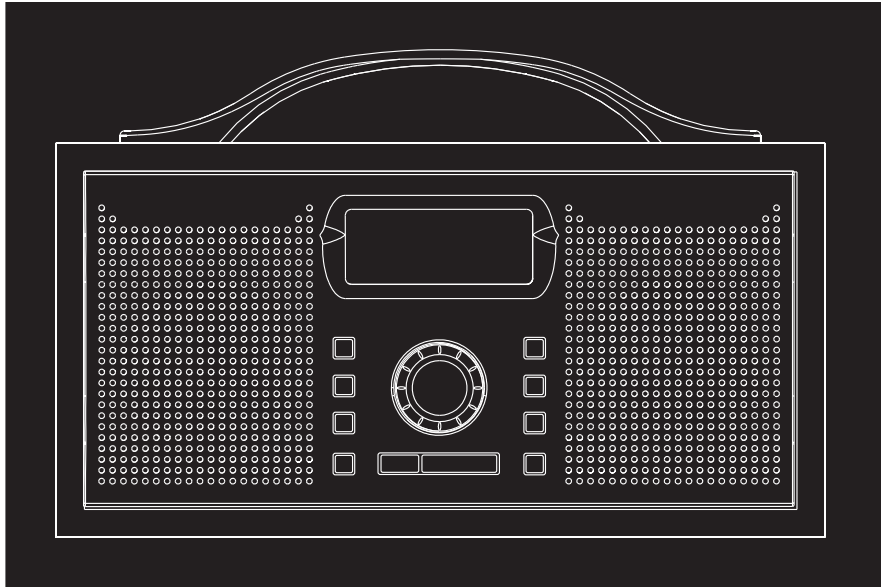

DAB-109F

Owner's Handbook

DAB Digital Radio with dual alarms

IMPORTANT SAFETY INFORMATION

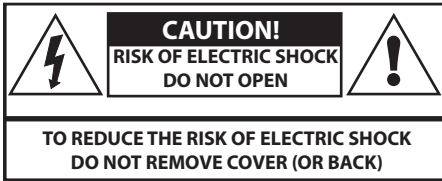

This symbol indicates that there are important operating and maintenance instructions in the literature accompanying this unit.



This symbol indicates that dangerous voltage constituting a risk of electric shock is present within this unit.

Read these instructions.

Keep these instructions.

Heed all warnings.

Follow all instructions.

Do not use this apparatus near water.

Clean only with a slightly damp cloth.

Do not block any ventilation openings.

Install in accordance with the manufacturer's instructions.

Do not install or operate near any heat sources such as radiators, stoves, or other apparatus that produce heat.

Unplug this apparatus during lightning storms or when unused for long periods of time.

Refer all servicing to qualified service personnel. Servicing is required when the apparatus has been damaged in any way, such as the power-supply cord or plug is damaged, liquid has been spilled or objects have fallen into the apparatus, the apparatus has been exposed to rain or moisture, does not operate normally, or has been dropped.

Warning: To reduce the risk of fire or electrical shock, do not expose this product to rain or moisture. The product must not be exposed to dripping and splashing and no object filled with liquids such as a vase of flowers should be placed on the product.

No naked flame sources such as candles should be placed on the product.

Caution: Changes or modifications not expressly approved by the manufacturer could void the user's authority to operate this device.

Caution: Usage of controls or adjustments or performance of procedures other than those specified herein may result in hazardous exposure.

IMPORTANT

This equipment generates, uses and can radiate radio frequency energy and, if not installed and used in accordance with the instructions, may cause harmful interference to radio communication. However, this is no guarantee that interference will not occur in a particular installation. If this equipment does cause harmful interference to radio or television reception, which can be determined by turning the equipment off and on, the user is encouraged to try to correct the interference by one of the following measures:

- Reorient or relocate the receiving antenna.
- Increase the separation between the equipment and receiver.
- Connect the equipment into an outlet on a circuit different from that to which the receiver is connected.
- Consult the dealer or an experienced radio/TV technician for help.

ELECTRICAL INFORMATION

Mains Supply: The mains operating voltage of this unit is marked on a rating plate on the rear of the unit.

The means of disconnecting this appliance from the mains supply is the mains plug. This should be unobstructed and readily operable at all times.

INDEX

INDEX

Introduction	2
Unpacking	2
Controls & connections	3
Display features	5
Fitting batteries	5
AC mains operation	6
Battery operation	6
Getting started	6
Station tuning	7
FM reception	7
Presets	7
Alarm functions	8
Sleep mode	9
Scanning	9
Manual tuning	9
Display modes	10
Headphones	11
System reset	11
Care & Maintenance	11
Specifications	11
Warranty	11

INTRODUCTION

Introduction

DAB (Digital Audio Broadcasting) technology allows many more radio stations compared to FM. DAB transmissions do away with problems of hiss and fade that plague AM and FM broadcasts and are less likely to be affected by adverse weather conditions or other sources of interference. In addition to speech and music DAB transmissions carry high levels of data - far greater than the limited RDS information available on FM stations.

Unlike FM, DAB is broadcast on many frequencies. Many countries in Europe, including the UK use Band III (174-230 MHz); others, France for example, use the L-Band (1452-1492 MHz). Germany uses both bands.

Your radio can tune Band III. Countries in Europe that use Band III include: Belgium, Denmark, Holland, Italy, Norway, Portugal, Spain, Sweden, Switzerland. Your radio will tune stations in all these countries.

Your radio cannot receive French or German stations broadcasting in the L-Band though FM services are available all over Europe.

Being digital, DAB transmissions can have a wider frequency range and greater dynamics than that available with FM technology.

FM reception is available on the DAB-109 for use in those locations where there is no usable DAB service.

A headphone output is provided for personal listening.

PRELIMINARIES

UNPACKING

Carefully unpack the unit. If it is damaged, please return it to your nearest Tesco store for replacement. Remember to take your purchase receipt with you.

Retain the User Handbook. If you pass the unit on to a third party make sure you pass on the handbook.

We suggest you retain the packaging. If you dispose of it, do so having regard to any recycling regulations in your area.

CONTENTS

The carton should contain:

- The DAB-109F digital radio
- Power cord
- Operating Manual

If any items are missing or damaged, contact your nearest TESCO store for a replacement. Have your receipt ready when you call. Retain the packaging. If you dispose of it, do so having regard to any recycling regulations in your area.

LOCATION

Place the unit on dry stable surface away from heat and damp and where it is unlikely to fall or be knocked over.

CONTROLS AND CONNECTORS

FRONT VIEW

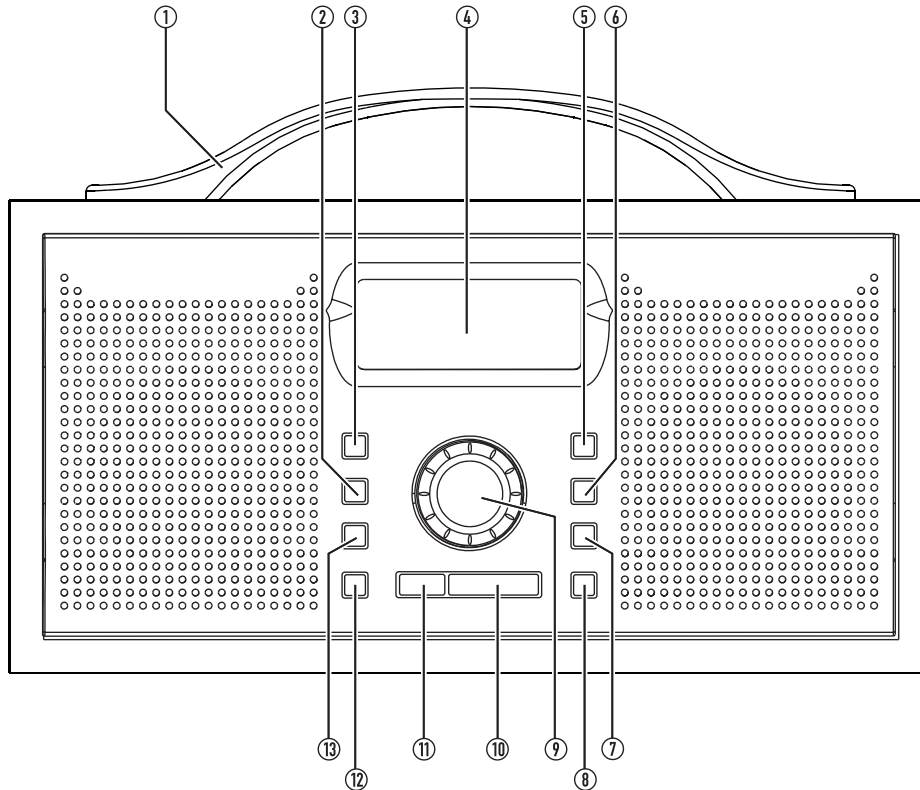

- ① Handle
- ② Presets button
- ③ Jog mode/Select button
- ④ Display
- ⑤ Alarm 1 button
- ⑥ Alarm 2 button
- ⑦ Sleep button
- ⑧ Info button
- ⑨ Volume/Select knob
- ⑩ Snooze button
- ⑪ Standby/On button
- ⑫ DAB/FM button
- ⑬ Menu button

CONTROLS AND CONNECTORS

BACK VIEW

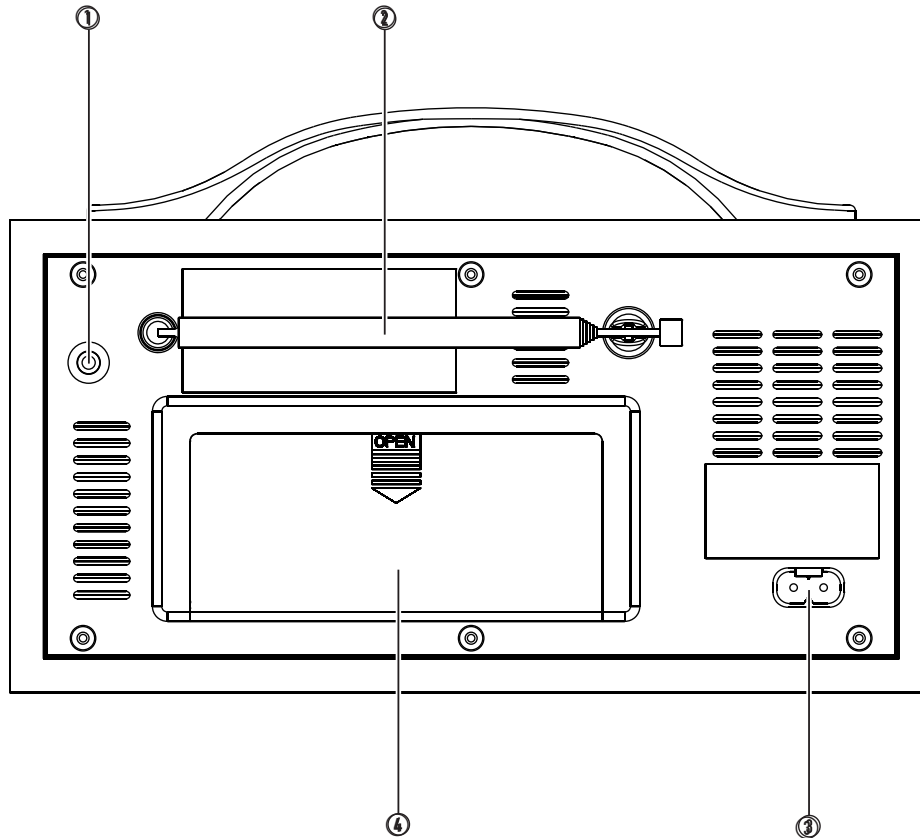

- ① Headphone jack
- ② DAB/FM aerial
- ③ AC Inlet
- ④ Battery compartment

DISPLAY FEATURES

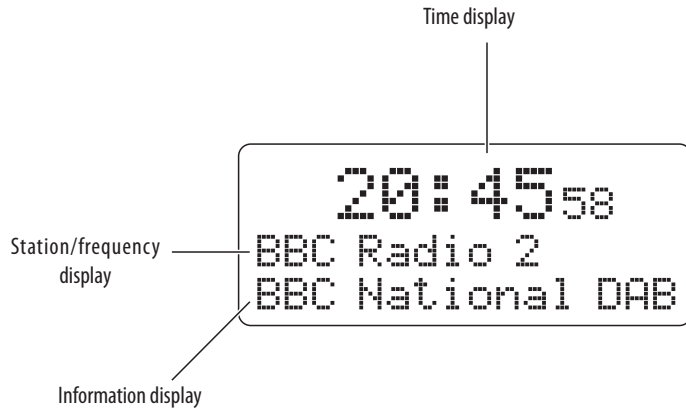

FITTING BATTERIES

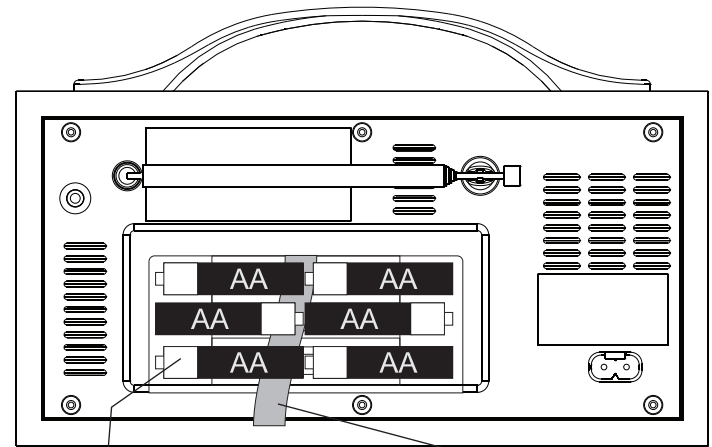

- ① Slide the battery cover off in the direction indicated
- ② Lay the ribbon across the battery compartment (this will assist with removing the batteries when exhausted).
- ③ Fit 6 x AA batteries, observing polarity as shown.
- ④ Slide the battery cover back into position on the radio.

AC MAINS OPERATION

CONNECTING POWER

- Check that the mains voltage marked on the rating plate on the back panel is the same as the voltage in your area.
- Plug the AC power cord into the AC inlet
- Plug the mains plug into the wall socket and switch the mains power on.

STANDBY CONTROL

To turn the radio on:

- Press the **STANDBY/ON**  button.

The display will light and the radio will tune to the last station used. If the power has been disconnected, the clock will set.

To turn the power off:

- Press the **STANDBY/ON**  button.

The radio and display light will switch off. The clock will continue to run whilst mains power is connected.

LOW POWER STANDBY

If preferred, you can change the standard Standby mode to 'Low Power' standby. In Low Power Standby mode the power consumption of your radio will be reduced to less than 1W when set to Standby.

NOTE:- When Low Power Standby mode is set the display will switch off completely when set to Standby and Alarm and Sleep functions are disabled.

To change to low-power Standby mode:

- Press the **STANDBY/ON**  button for at least five seconds.

To return to normal Standby mode:

- Press the **STANDBY/ON**  button for at least five seconds.

BATTERY OPERATION

FITTING BATTERIES

Referring to the diagram on the previous page, fit 6 x AA batteries into the battery compartment. Alkaline batteries are recommended for best performance.

POWER CONTROL

To turn the radio on:

- Press the **STANDBY/ON**  button.

The display will light, the radio will tune to the last station used, and the clock will set.

To turn the power off:

- Press the **STANDBY/ON**  button.

The radio and display will switch off.

NOTE:- The **STANDBY/ON** button functions as a Power On/Off button during battery operation - the display will switch off completely when set to Standby and Alarm and Sleep functions are disabled.

BATTERY DISPOSAL

Dispose of used batteries with regard to the recycling regulations in your area. Do NOT short circuit batteries or throw them into water, the general rubbish or in a fire.

Weak batteries can leak and damage the remote control.

Replace them in good time!

GETTING STARTED

DAB/FM AERIAL

Before using your radio for DAB or FM reception, always unclip and fully extend the aerial. The aerial has a rotating base to enable adjustment for maximum signal strength.

SETTING THE CLOCK

The clock on your radio is automatically set when first used from the time signal broadcast with DAB radio stations.

The clock is not set by the user.

INITIAL SCAN

When your radio is used for the first time:

The radio scans all usable stations (full scan) and stores them alphanumerically -1 Radio, 2 Radio, AA Radio, AB Radio...

The initial scan will take a few minutes. After the scan, the number of stations found will be displayed, the clock will be set, the radio will display the first station in the sequence and begin playing at the default system volume of 10.

Note: If no stations are found after the scan, '0 Services Found'; then 'Service N/A' will be displayed. If this happens, switch the radio off and move it to a location with a stronger signal.

When you switch the radio back on it will automatically repeat the scan process.

ADJUSTING THE VOLUME

To increase the volume:

- Turn the **VOLUME/SELECT** knob clockwise.

To decrease the volume:

- Turn the **VOLUME/SELECT** knob anti-clockwise.

SELECTING A DAB STATION

The stations are stored in an alphanumeric list.

To select another station

- Press the **JOG MODE/SELECT** button to switch to tuning mode.

'Station List' appears on the display.

- Turn the **VOLUME/SELECT** knob to browse through the list of station names on the display.
- When you find the station name you want to listen to, press the **JOG MODE/SELECT** button.

FM RECEPTION

Your radio can also receive FM band radio stations.

To change to the FM band

- Press the **DAB/FM** button.

To auto-tune to FM stations

- Press and **hold** the **JOG MODE/SELECT** button to tune to the next station in the band.

Searching... will appear on the display and the radio will start to search. Tuning will stop automatically when the station is reached.

To manually tune to FM stations

- Press the **JOG MODE/SELECT** button **briefly** to select manual FM tuning mode.

<TUNING> appears on the display.

- Turn the **VOLUME/SELECT** knob to tune manually up or down the band and search for a station.

STEREO/MONO RECEPTION

You can set your radio to switch automatically between stereo and mono FM reception (AUTO mode) or to receive in mono only (MONO mode). Setting to mono mode may improve sound quality in areas where a weak aerial signal results in a high level of background noise.

To switch between FM AUTO and MONO modes

- Press the **MENU** button.

The legend 'Auto' or 'Mono' will be displayed to indicate which mode is set.

STATION PRESETS

DAB and FM presets

Your radio can store up to 10 of your favourite stations as presets on both the DAB and FM bands for quick recall.

To store a preset

- Tune to the station you want to store as a preset.
- Press and **hold** the **PRESETS** button.

A preset number will be displayed on the bottom line of the display.

- To choose a preset location to store your station, turn the **VOLUME/SELECT** knob to find your preferred preset number, then press the **JOG MODE/SELECT** button.

When you store a preset, the display will read 'PRESET SAVED' to confirm the number you selected.

NOTE: You can choose a preset number that is already in use. The new station details will over-write the stored station.

To recall a preset

- Press the **PRESETS** button.
- Turn the **VOLUME/SELECT** knob to find the preset number you want.
- When you find the preset station you want, stop browsing the preset list and the radio will tune to the selected station.

NOTE:- Your radio may have been pre-programmed with a selection of DAB station presets. If so, these stations will be listed on a label fixed to the front panel.

ALARM FUNCTIONS

Your radio includes a dual alarm function. The two alarms, ALARM 1 and ALARM 2 can be set with different wake-up times, then you can set either or both alarms to wake you. You can also choose to be woken by a beep sound, a DAB station preset or an FM station preset. Before using the alarms, you must store your preferred wake-up settings.

STORING PREFERRED WAKE-UP SETTINGS:

- Press and **hold** the **ALARM 1** or **ALARM 2** button to choose the alarm you want to set.

The display will confirm which alarm (ALARM 1 or ALARM 2) you selected. The alarm time will be shown with the hours digits flashing.

- Turn the **VOLUME SELECT** control to set the hours digits.
- Press the **JOG MODE/SELECT** button to confirm the hours setting.

The minutes digits will flash.

- Turn the **VOLUME SELECT** control to set the minutes digits.
- Press the **JOG MODE/SELECT** button to confirm the minutes setting.

The display will now show a DAB preset number .

- Turn the **VOLUME/SELECT** control to choose a DAB preset station to wake to.
- Press the **JOG MODE/SELECT** button to confirm.

The display will now show an FM preset number .

- Turn the **VOLUME/SELECT** control to choose an FM preset station to wake to.
- Press the **JOG MODE/SELECT** button to confirm.

The display will now show a buzzer tone number.

- Turn the **VOLUME/SELECT** control to choose from buzzer tone 1 or 2 for this alarm.
- Press the **JOG MODE/SELECT** button to confirm.

NOTE:- Refer to the previous page (STATION PRESETS) for information on how to store preset stations. If you choose an

unassigned 'free' preset number in error, the alarm will default to the BEEP wake-up setting.

The display will now show the legend 'VOLUME'.

- Turn the **VOLUME/SELECT** control to choose your preferred wake-up volume level.
- Press the **JOG MODE/SELECT** button to confirm the wake-up volume setting.

NOTE:- Ensure that the wake-up volume settings are set at a high enough level to wake you.

ACTIVATING THE ALARMS:

Once you have stored your preferred wake-up settings, you can activate either or both of the alarms to wake you.

To activate your chosen alarm:

- Press the **ALARM 1** or **ALARM 2** button repeatedly to cycle through the wake up options you can choose from the list as shown below-

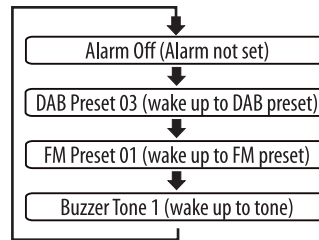

- Set the radio to Standby before going to sleep.

NOTE:- The above examples show DAB preset 3, FM preset 1 and Buzzer tone 1 as preferred wake-up settings.

If either of the alarms have been set to wake you, the ALARM symbols will be displayed in the position shown below.

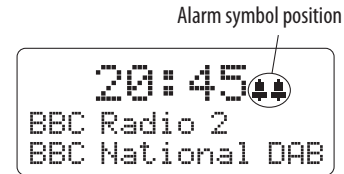

The three symbols are shown below, indicating which alarm is set.



WHEN THE ALARM SOUNDS

The alarm will continue to sound for one hour before switching off automatically.

To switch off the alarm before this time

- Press the **ALARM 1** or **ALARM 2** button to switch off the alarm that is sounding.

To extend the alarm for a further 5 minute 'snooze'.

- Press the **SNOOZE** button to switch off the alarm that is sounding.

The alarm will switch off for a 5 minute period, and the 'z' symbol will show on the display to indicate 'snooze' mode.

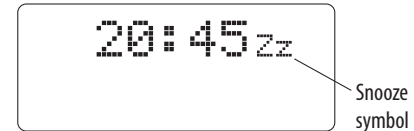

NOTE:- The snooze function can be selected repeatedly until the alarm switches off after one hour.

SLEEP MODE

THE SLEEP FUNCTION

The Sleep function allows you to program your radio to switch itself off after a set period of 90, 80, 70, 60, 30 or 10 minutes.

To activate the Sleep function:

- Press the **SLEEP** button.

The display will show Sleep Timer 90 minutes.

- Now press the **SLEEP** button repeatedly until your required sleep time appears on the display.

After a few seconds the Sleep display will disappear and the 'SLEEP' symbol will appear on the display with confirmation of the sleep minutes you set (8=80 minutes, 6=60 minutes etc).

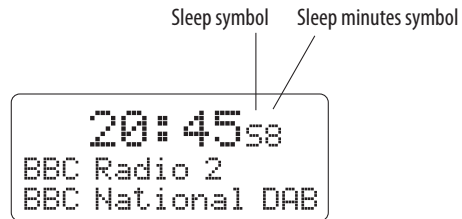

Your radio will continue to play, then will set to Standby when the sleep time expires.

To cancel the Sleep function once set:

- Press the **SLEEP** button during Sleep mode.

SCANNING

When first used, your radio scanned the DAB band for available stations. The station services found were then stored in your radio's memory.

You can re-scan the band at any time if you move to a different area or just to refresh the stored list of available stations.

Two types of scan are available, a Local Scan that scans UK DAB bands for available services and a Full Scan, that scans all bands.

TO START A SCAN

- Switch on the radio and select the DAB band.
- Press the **MENU** button **briefly**.
- Rotate the **VOLUME/SELECT** knob to display your choice of scan - Autoscan local or Autoscan full.
- Press the **JOG MODE/SELECT** button to start the scan.

The scanning display will be shown while the scan takes place.

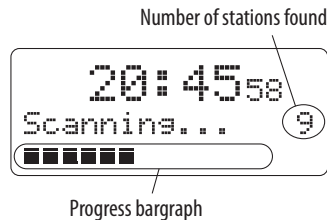

A bargraph shows scan progress and the number of services found is displayed.

MANUAL TUNING

If preferred, you can also tune DAB stations manually.

To Manually tune:

- Press the **MENU** button **briefly**.

The radio will now display the legend 'Manual tune'.

- Press the **JOG MODE/SELECT** button to select manual tuning.
- Rotate the **VOLUME/SELECT** knob to browse the DAB multiplex channels.
- Press the **JOG MODE/SELECT** button to display information about a multiplex channel.

If a station multiplex is located on the selected channel, the multiplex name and frequency will be displayed above a signal strength bargraph.

DISPLAY MODES

DAB DISPLAY MODES

When playing a DAB station you can change the information on the display by changing the display mode.

To change the display mode from the default of Scrolling station text information:

- Press the **INFO** button repeatedly to cycle through the options listed in the chart below.

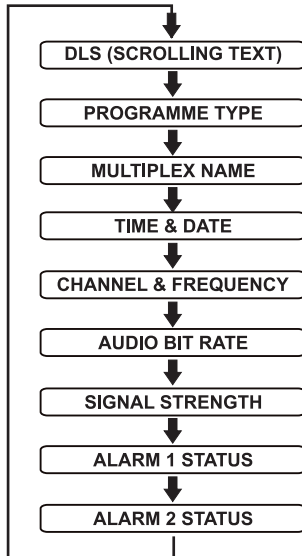

DLS (SCROLLING TEXT): This is a scrolling message giving real-time information - song titles, news headlines, etc.

PROGRAMME TYPE: This describes (when available) the style of the programme being broadcast.

MULTIPLEX NAME (GROUP NAME): is the name of the DAB Multiplex that is currently tuned.

TIME & DATE: Shows the current time and date. Time and date are updated by broadcasted information.

CHANNEL & FREQUENCY: The multiplex channel number and frequency are displayed.

AUDIO BIT RATE: DAB allows broadcasters to vary the BIT RATE (or the amount by which an audio signal can be compressed) depending on the type of broadcast. This enables the amount of stations on a multiplex to be maximised. Speech and News are often broadcast at a lower Bit Rate; music needs a higher Bit Rate for good fidelity.

SIGNAL STRENGTH: This bargraph indicates the quality of the signal being received. The maximum signal strength displayed is indicated by 8 bar segments.

In low signal areas, adjusting the aerial to increase the signal strength indication will improve reception quality.

ALARM 1 STATUS: Briefly displays the status of ALARM 1, then returns to display scrolling text.

ALARM 2 STATUS: Displays the status of ALARM 2, then returns to display scrolling text.

FM DISPLAY MODES

Pressing the **INFO** button repeatedly when in FM mode will cycle the display through the available FM display options.

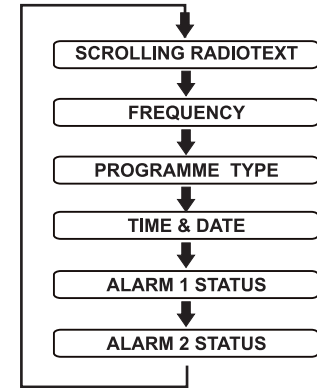

RDS (SCROLLING TEXT): This is a scrolling message giving real-time information - song titles, news headlines, etc.

FREQUENCY: The station frequency is displayed.

PROGRAMME TYPE: This describes (when available) the style of the programme being broadcast.

TIME & DATE: Shows the current time and date. Time and date are updated by broadcasted information.

ALARM 1 STATUS: Briefly displays the status of ALARM 1, then returns to display scrolling text.

ALARM 2 STATUS: Displays the status of ALARM 2, then returns to display scrolling text.

HEADPHONES

There is a headphone output socket on the back panel of the radio. If headphones are connected to this socket for private listening, the speakers will cut out automatically.

SYSTEM RESET

DAB is a terrestrial system and frequencies in different areas vary. If you move the radio to another part of the country performing a Full Scan may not be enough to re program the radio you may need to reset the radio.

To restore the factory settings:

- Press and **hold** the **MENU** button until the display shows 'Press SELECT to confirm reset'.
- Press the **JOG MODE/SELECT** button to confirm reset.

'Restarting' will appear on the display.

The Radio will now search the DAB broadcast stations in your area.

After reset all settings are returned to the factory defaults and any stored presets are erased.

SOFTWARE VERSION

You can display the version of software used in your radio. This will only be necessary as an aid for technicians should your radio ever need service.

To display the software version:

- Press and **hold** the **INFO** button.

The software version will appear on the display.

CARE AND MAINTENANCE

AFTER USING YOUR RADIO

- Set to Standby.
- Switch the unit off at the mains and unplug it if you are leaving it unattended for a long period (holidays etc).

CARE AND CLEANING

All care and cleaning operations should be carried out with the unit unplugged from the mains power. Occasionally wipe the cabinet with a lint free duster. Never clean the unit with liquids or solvents.

SPECIFICATIONS

SPECIFICATIONS

Supply Voltage, AC mains : ...220-240 V~, 50Hz
Supply Voltage, Battery :9V --- (AA/UM3 x 6)
Max. Power Consumption 10 W
DAB:174 -240 MHz
FM:87.5-108 MHz
Net Weight: 1.53 kg



Class II construction double insulated.
This product must not be connected to earth.

WARRANTY

Your Tesco appliance is covered by a warranty for 12 months from the date of purchase. If a fault develops during this period, please contact the TESCO electrical help line on 0845 456 6767. Please have your original purchase receipt with you when you call. This warranty in no way affects your consumer rights.



UK: Waste electrical products /batteries should not be disposed of with household waste. Separate disposal facilities exist, for your nearest facilities. See www.recycle-more.co.uk or in-store for details.

ROI: Produced after 13th August 2005. Waste electrical products/batteries should not be disposed of with household waste. Please recycle where facilities exist. Check with your Local Authority or retailer for recycling advice.

Technika

Tesco Stores Ltd,
Delamare Road, Cheshunt, Herts, EN8 9SL

► **Technika Helpline: 0845 456 6767** (Calls cost up to 4p per minute from a BT landline, other providers may vary)

DAB-109FV0.1

Free Manuals Download Website

<http://myh66.com>

<http://usermanuals.us>

<http://www.somanuals.com>

<http://www.4manuals.cc>

<http://www.manual-lib.com>

<http://www.404manual.com>

<http://www.luxmanual.com>

<http://aubethermostatmanual.com>

Golf course search by state

<http://golfingnear.com>

Email search by domain

<http://emailbydomain.com>

Auto manuals search

<http://auto.somanuals.com>

TV manuals search

<http://tv.somanuals.com>