TEK DSA 600
SERIES

Part No. 070-8180-00
Product Group 47

**THE
DSA 601A
& DSA 602A**
DIGITIZING SIGNAL
ANALYZERS

Tutorial

*Please check for CHANGE INFORMATION
at the rear of this manual.*

First Printing FEB 1991
Revised MAY 1991

Tektronix[®]
COMMITTED TO EXCELLENCE

Instrument Serial Numbers

Each instrument manufactured by Tektronix has a serial number on a panel insert or tag, or stamped on the chassis. The first letter in the serial number designates the country of manufacture. The last five digits of the serial number are assigned sequentially and are unique to each instrument. Those manufactured in the United States have six unique digits. The country of manufacture is identified as follows:

B010000	Tektronix, Inc., Beaverton, Oregon, USA
E200000	Tektronix United Kingdom, Ltd., London
J300000	Sony/Tektronix, Japan
H700000	Tektronix Holland, NV, Heerenveen, The Netherlands

Instruments manufactured for Tektronix by external vendors outside the United States are assigned a two digit alpha code to identify the country of manufacture (e.g., JP for Japan, HK for Hong Kong, etc.).

Tektronix, Inc., P.O. Box 500, Beaverton, OR 97077

Copyright © Tektronix, Inc., 1991. All rights reserved. Tektronix products are covered by U.S. and foreign patents, issued and pending. The following are registered trademarks: TEKTRONIX, TEK, TEKPROBE, SCOPEMOBILE and 

Centronics® is a registered trademark of Data Computer Corporation.

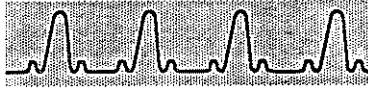

Related Manuals

Other manuals that complete the documentation set for the DSA 601A and DSA 602A Digitizing Signal Analyzers are:

- The *DSA 601A and DSA 602A User Reference* (Tektronix part number 070-8181-00) covers all aspects of front panel operation. Use this manual to quickly gain information about a specific topic, or to get an overview of the menu system.
- The *DSA 601A and DSA 602A Programmer Reference* (Tektronix part number 070-8182-00) describes using a computer to control the DSA through GPIB or RS-232-C interfaces and describes the commands used to program the DSA.
- The *DSA 601A and DSA 602A Quick Reference* (Tektronix part number 070-8183-00) provides an index of operations, and the front-panel steps to invoke each operation.
- The *DSA 600 Series Service Reference* (Tektronix part number 070-8184-00) provides information to maintain and service components of the DSA, and provides a complete board-level description of DSA operation.

About This Manual



If you are unfamiliar with the DSA 601A and DSA 602A, you will want to read this manual first.

Read this manual to familiarize yourself with the DSA 601A and DSA 602A Digitizing Signal Analyzers and to learn about their capabilities. There are examples in this manual that will help you learn how to use the DSA. There are additional manuals that provide reference information and information about programming the DSA.

The first section of this manual presents operator information about physically installing the DSA, installing plug-in units, and connecting cables to the DSA. Examine this information carefully; it contains important safety information.

The remainder of this manual presents a series of examples that will help you quickly learn the capabilities of the DSA.

Contents

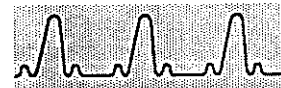

Operator Overview	1
DSA 601A and DSA 602A Digitizing Signal Analyzer Description	3
Description of Signal Digitizing	5
Safety	6
Electrical Connections	8
Installation	11
Getting Started	13
Example 1: Displaying a Waveform	15
Example 2: Managing Multiple Waveforms	29
Example 3: Defining Complex Waveforms	41
Example 4: Using Signal Processing	53
Measurements	65
Stored Waveforms	65
Example 5: Taking Automated Measurements	67
Example 6: Comparing Measurements to a Reference ..	77
Example 7: Taking Delay Measurements Using Cursors .	81
Example 8: Comparing Displayed to Stored Waveforms .	93
Example 9: Using the Disk Drive to Store Waveforms ...	99
Glossary	113
Index	119
Change Information	

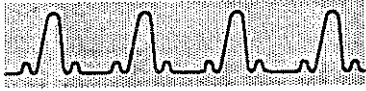



Operator Overview



This section describes the safety precautions, power and signal connections, and procedures you should follow when installing the DSA 601A or DSA 602A Digitizing Signal Analyzer.



DSA 601A and DSA 602A Digitizing Signal Analyzer	
Description	3
Description of Signal Digitizing	5
Safety	6
Terms in Manuals	6
Terms on Equipment	6
Symbols in Manuals	6
Symbols on Equipment	6
Power Source	7
Grounding the DSA	7
Use the Proper Fuse	7
Do Not Remove Covers or Panels	7
Do Not Operate in Explosive Atmospheres	7
Electrostatic Discharge	7
Electrical Connections	8
Front Panel	8
Rear Panel	9
Installation	11



DSA 601A and DSA 602A Digitizing Signal Analyzer Description

The DSA 601A and DSA 602A Digitizing Signal Analyzers provide unprecedented capabilities in capturing and accurately measuring high-speed electrical events. Some of the main features of these DSAs are:

- Fast rise time and bandwidth up to 1 GHz, depending on the plug-in amplifier you use.
- Sweep speeds from 50 picoseconds per division to 100 seconds per division, adjustable in a calibrated 1-2-5 sequence.
- 1 GSample/s (2 GSample/s for the DSA 602A) sampling rate for high system throughput and real-time display.
- Simultaneous display of up to eight waveforms. Each waveform can represent a single input channel, or a complex expression that mathematically combines multiple input channels, or an expanded window of another waveform.
- Up to 12 input channels using four-channel plug-in amplifiers.
- Digital waveform capture, display, and storage.
- A 3.5 inch PC compatible floppy disk drive for storing and recalling waveforms and settings.
- A bright, stable display even with signals of low repetition rate.
- Waveforms are captured with 8-bit vertical resolution, and can have from 512 to 32,768 points each.
- Automatic measurement capability that allows a wide variety of complex measurements on a waveform and gives real time updating. The measurements include rise time, fall time, rms voltage, delay, width, period, and frequency.
- An Autoset function that allows quick adjustment of settings by pressing a single button.

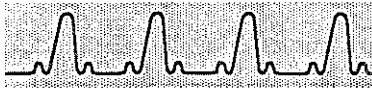

- Menu driven touch-screen operation that simplifies operator control of the DSA. Only the choices that are appropriate are available for selection at any time.
- Programmable control of the DSA that allows you to operate it from an attached computer or instrument controller via the RS-232-C or GPIB interfaces.
- Enhanced Accuracy system that assures accurate, stable waveform data and measurement results.

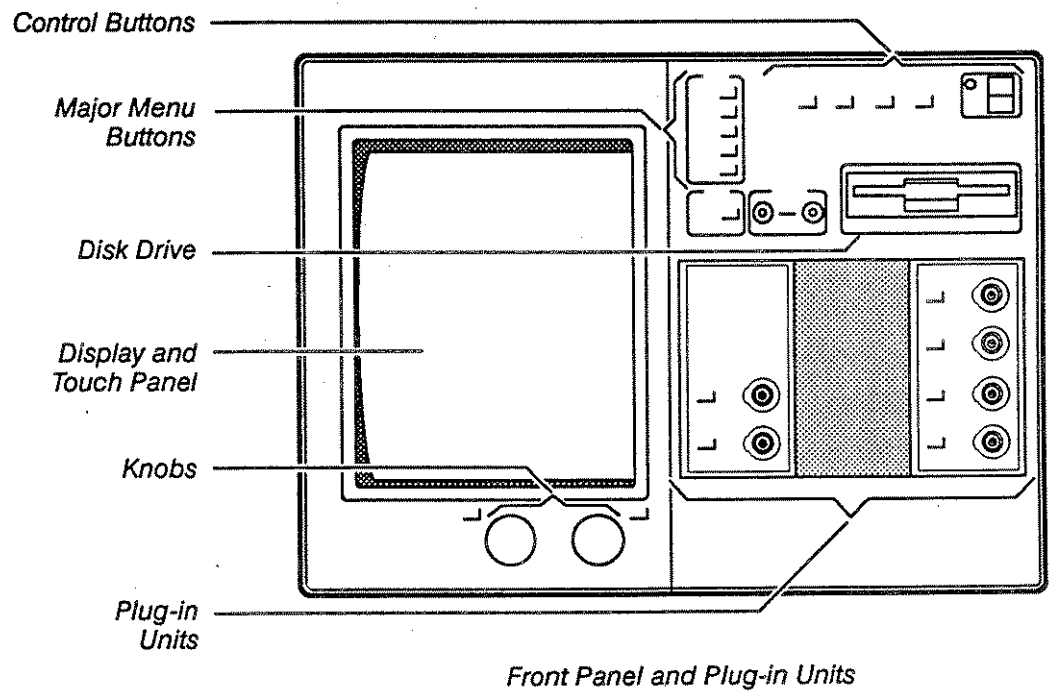

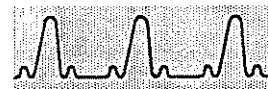

Description of Signal Digitizing

A traditional analog oscilloscope displays a waveform dynamically as a beam sweeps across the display horizontally. Unlike traditional oscilloscopes, the DSA separates a waveform into discrete digital samples.

The DSA operates in two modes: real-time and equivalent-time. When one sweep is sufficient to sample, digitize, and display an entire waveform, the DSA is in real-time operation.

When the sweep is too fast for all of the waveform samples to be digitized, the DSA changes to "equivalent-time" operation. In equivalent time, only part of the waveform is sampled on any given sweep. After several passes, the DSA collects and assembles the samples to display an entire waveform.

The DSA uses real-time operation whenever possible. Whenever the sampling interval, the time between displayed digitized samples of the waveform, is less than 1 nanosecond (500 ps for the DSA 602A), the DSA automatically switches to equivalent time operation. An on-screen indicator (**RT** or **ET**) below the graticule always shows you whether the DSA is in real-time or equivalent-time operation.

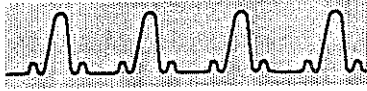

Safety

The following safety information is provided for your protection and to prevent damage to the DSA. This safety information applies to all operators and service personnel.

Terms in Manuals

- **CAUTION** statements identify conditions or practices that could result in damage to the equipment or other property.
- **WARNING** statements identify conditions or practices that could result in personal injury or loss of life.

Terms on Equipment

- **CAUTION** indicates a personal injury hazard not immediately accessible as one reads the marking, or a hazard to property including the equipment itself.
- **DANGER** indicates a personal injury hazard immediately accessible as one reads the marking.

Symbols in Manuals



Static Sensitive Devices

Symbols on Equipment



DANGER
High Voltage



*Protective
ground (earth)
terminal*



ATTENTION
*Refer to
manual*

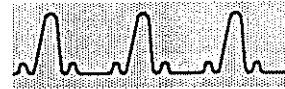

Power Source

The DSA is intended to operate from a power source that will not apply more than 250 V rms between the supply conductors or between either supply conductor and ground.

Grounding the DSA

The DSA is grounded through the power cord. To avoid electric shock, plug the power cord into a properly wired receptacle where earth ground has been verified by a qualified service person. Do this before making connections to the input or output terminals of the DSA.

Without the protective ground, all parts of the DSA are shock hazards. This includes knobs and controls that may appear to be insulators.

Use the Proper Fuse

Using an improper fuse can create a fire hazard. Always use fuses that exactly meet the specifications in the DSA parts list. Match fuse type, voltage rating, and current rating.

Do Not Remove Covers or Panels

To avoid personal injury, do not operate the DSA without the panels or covers.

Do Not Operate in Explosive Atmospheres

The DSA provides no explosion protection from static discharges or arcing components. Do not operate the DSA in an atmosphere of explosive gases.

Electrostatic Discharge

Never apply a voltage to a plug-in amplifier that is outside the range printed on the front panel of the plug-in amplifier. Operate the DSA only in a static-controlled environment.

CAUTION
Operating the DSA without the covers in place may cause overheating and damage.

 **CAUTION**
Applying a voltage outside the range printed on the plug-in amplifier can result in damage. Static electricity is also a hazard.



Electrical Connections

CAUTION
Never install or remove a plug-in unit when the DSA power is on.

Front Panel

The front panel has three compartments for plug-in units. At least one plug-in unit must be installed in the DSA to allow it to sample signals. To install a plug-in unit, place it into a compartment and push it in with firm pressure. To remove a plug-in unit, pull it out of the DSA using the small tab in the lower left corner of the plug-in unit.

The **CALIBRATOR** output connector is located above the compartments for plug-in units.

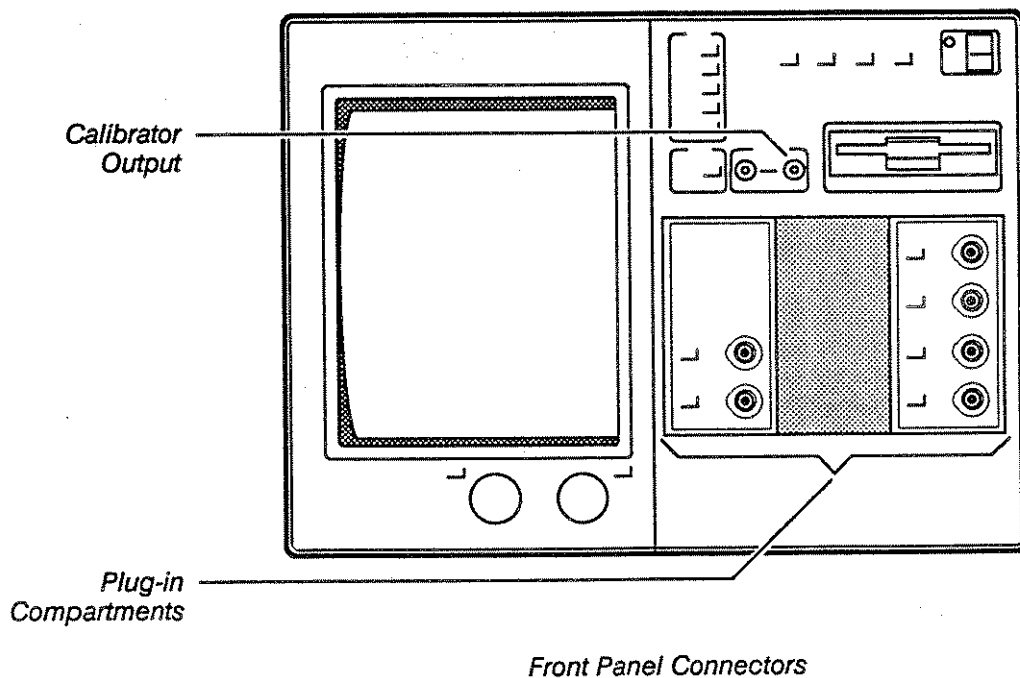

Rear Panel

The **POWER** plug provides AC power to the DSA. The plug is an IEC-style connector; the separate power cord supplied with the DSA should match the physical configuration of electrical outlets in your country.

CAUTION
Set the **LINE VOLTAGE SELECTOR** switch before connecting the DSA to your power system.

Before connecting the power cord from your electrical outlet to the DSA **POWER** plug, make sure that the adjacent **LINE VOLTAGE SELECTOR** switch is set to match the voltage range of the electrical system of your country. The main fuse and **PRINCIPAL POWER SWITCH** are near these controls.

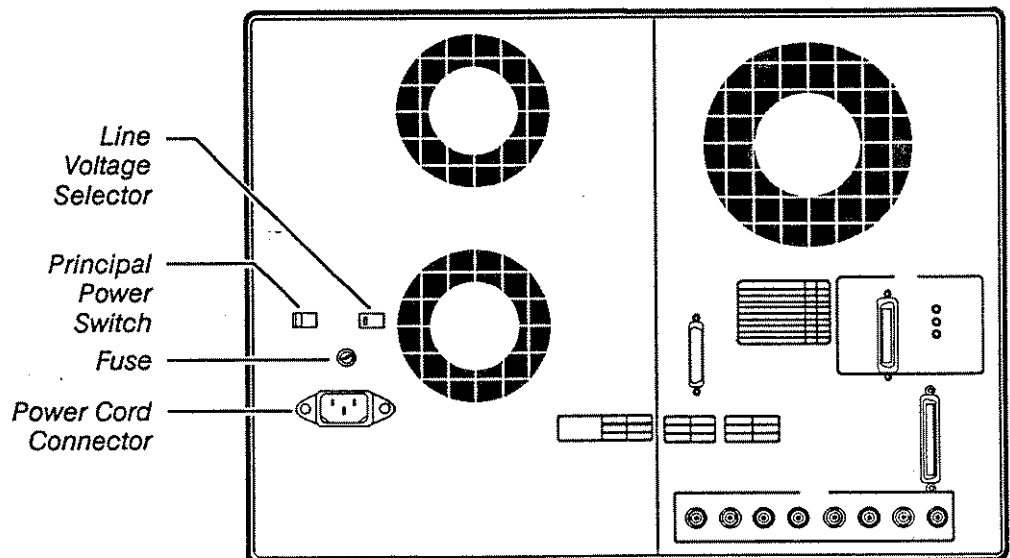

Rear Panel Power Connectors and Switches



The **RS-232-C (DCE)** connector lets you connect a computer, terminal, or modem to the DSA. The **GPIB** section similarly has an **IEEE STD 488 PORT** connector. With these connector configurations, you can make the DSA part of an automated test and measurement system.

The **PRINTER** connector provides a Centronics-style interface so you can connect a printer to the DSA. This lets you make a paper copy of the display by pressing the **HARDCOPY** button on the front panel. Hardcopy information can also be routed through either the **RS-232-C** or **IEEE STD 488 PORT** connector.

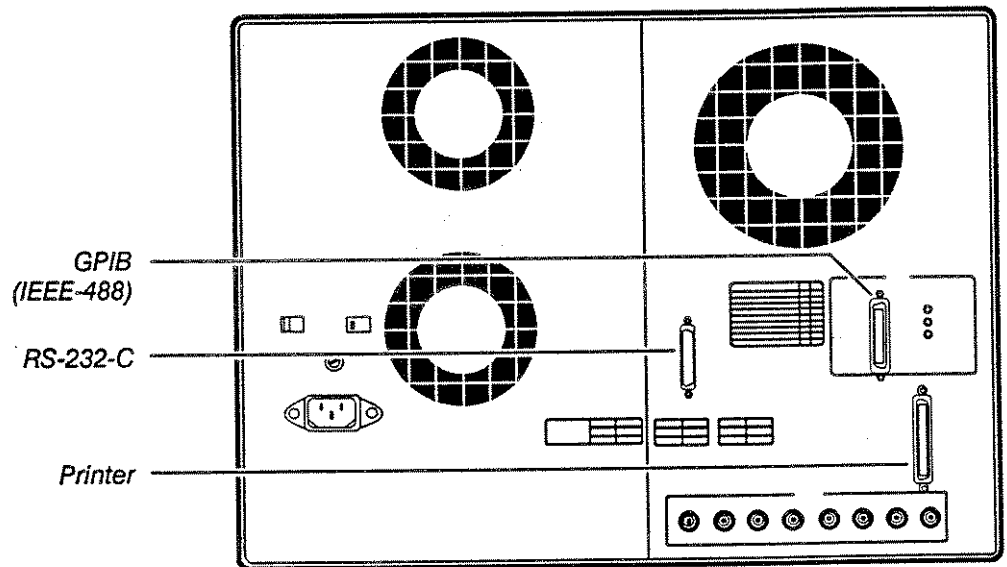

Rear Panel Input and Output Connectors

Installation

Follow this sequence when you install the DSA.

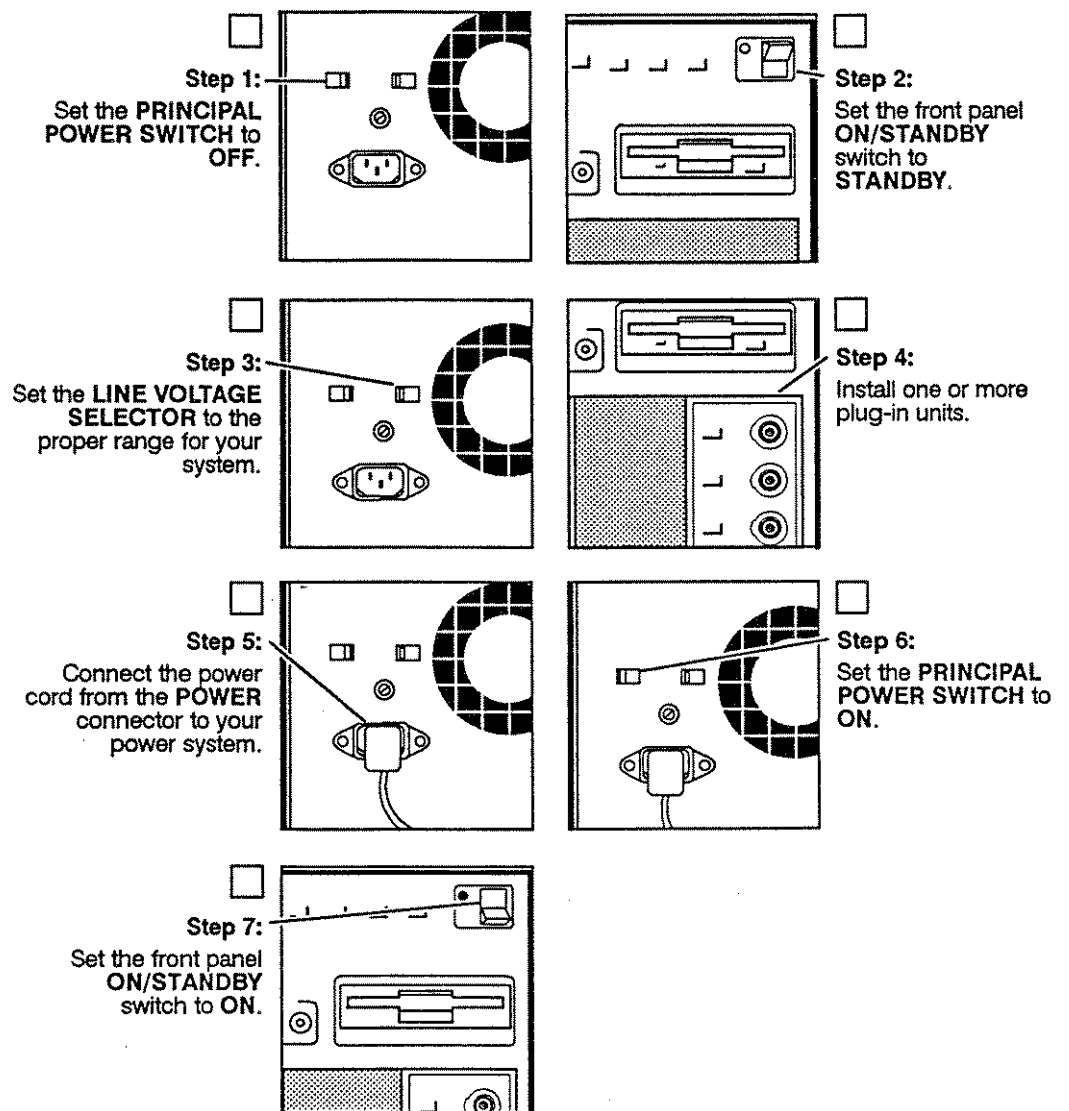

Once the DSA is installed, use the **ON/STANDBY** switch as a power switch.



Getting Started



This section presents four examples that illustrate how to use the DSA 601A and DSA 602A Digitizing Signal Analyzers. You will learn about:

- Using the front panel buttons, touch panel, and on-screen menus
- Creating and removing waveforms
- Using signal inputs
- Using the automatic set-up (Autoset) features
- Using the knobs and assigning knob functions
- Establishing a dual-graticule display
- Creating window (delayed sweep) waveforms

The plug-in amplifier that you use for these examples must be capable of setting channel impedances to 1 M Ω or more.

A pocket signal generator (Tektronix part number 015-0580-00) is included with this manual. You can execute all the examples using just this signal generator, your DSA, and a multichannel plug-in amplifier installed in the left plug-in compartment. You can substitute two single-channel plug-in amplifiers installed in the left and center compartments.

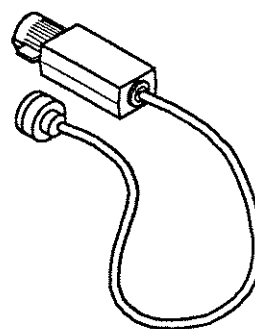

The Pocket Signal Generator

Once you have completed these four examples, you can begin working on your own, or you can examine the other examples in this manual that pertain to your specific work.

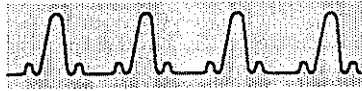

Example 1: Displaying a Waveform	15
Major Menu Buttons	15
The Touch Panel	18
Menu Selectors	18
Connecting Signals	19
Autoset	20
The Knobs	22
Icons	23
Pop-Up Menus	25
Keypad Pop-Up Menu and Knob Resolution	25
Major Menu Knob Assignments	27
Example 2: Managing Multiple Waveforms	29
Selecting Waveforms by Touch	32
Selecting Waveforms Using the All Waveforms Status Menu	34
Labeling Waveforms	35
Displaying Dual Graticules	38
Removing Waveforms	40
Example 3: Defining Complex Waveforms	41
Waveform Descriptions	43
Vertical Adjustment of Complex Waveforms	46
Calculated Waveforms	49
Windows	50
Example 4: Using Signal Processing	53
Trigger Coupling	55
Infinite Persistence Mode	56
Averaging and Enveloping	59
Record Length	63

Example 1: Displaying a Waveform



NOTE
Never install or remove a plug-in unit while the DSA power is on.
Read the Operator Overview section for information about installing your DSA.

This example shows how you can quickly display a meaningful waveform. You will also become familiar with the basic DSA controls.

For this example you will need a DSA 601A or DSA 602A with at least one plug-in amplifier installed in the left compartment. You will also need the pocket signal generator.

You will begin by initializing the DSA to its default settings. Each example in this manual begins with this step.

Major Menu Buttons

To the right of the display is a column of five buttons grouped under the title **MENUS**. Each button has an indicator light that shows which button was pressed last. Associated with each button is a major menu at the bottom of the display.

You may wish to press different major menu buttons and observe the changes on the display. Each major menu presents a group of controls that are related to each other.

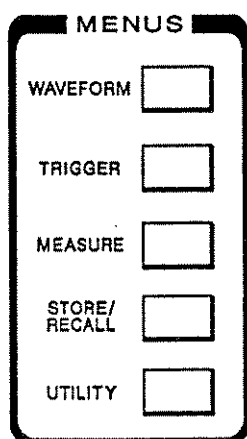

- **WAVEFORM** controls waveform definition, plug-in units, and acquisition.
- **TRIGGER** controls triggering parameters, including trigger source, coupling, and slope.
- **MEASURE** controls the automatic measurement system.
- **STORE/RECALL** controls storage and recall of waveform data and DSA settings.
- **UTILITY** controls general DSA parameters such as display colors, GPIB and RS-232-C settings, disk drive operations, and the clock.

Example 1: Displaying a Waveform

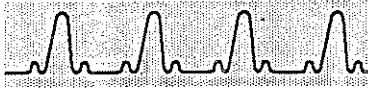

The Store/Recall, Measure and Waveform major menus have two pages each. The Utility major menu has three pages. Pressing the appropriate menu button displays one page of the major menu. Pressing the same button again displays the next page of the major menu.

The Utility 1 major menu contains the selector used to initialize the DSA to default settings.

- Step 1: Press the major menu **UTILITY** button, located in the **MENUS** column. This illuminates the **UTILITY** button's label and displays the Utility 1 major menu, as shown on the next page. If you see a different major menu than that shown on the opposite page, press the **UTILITY** button until the correct major menu appears.

Example 1: Displaying a Waveform

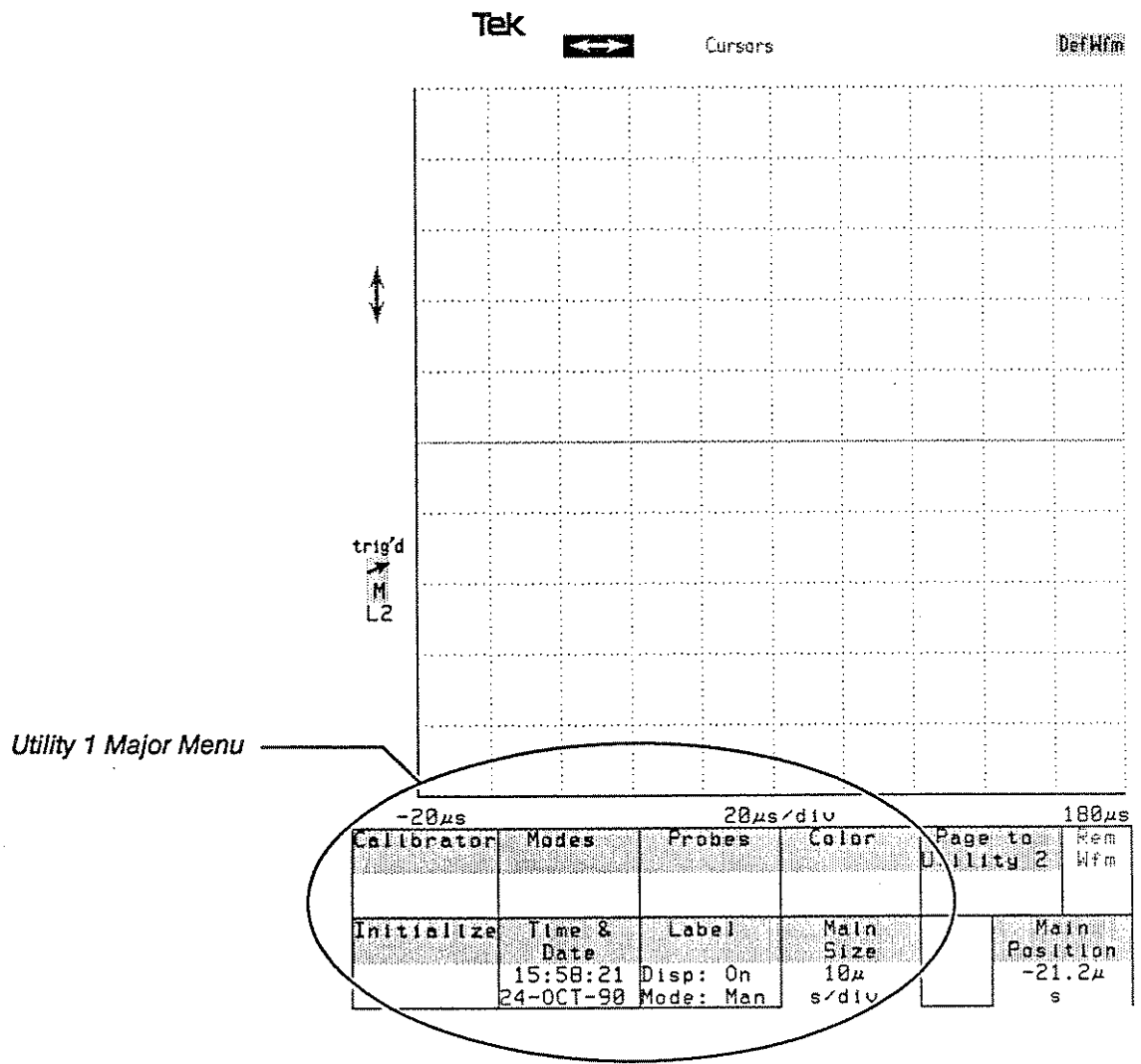
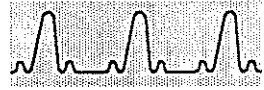

Utility 1 Major Menu on the Display

Example 1: Displaying a Waveform

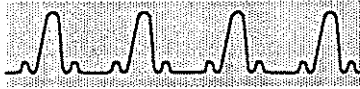

The DSA does not perform any operation until you *remove* your finger from the display.

Be sure that the **ON** label beside the **TOUCH PANEL** button is lighted. This button is below the major menu buttons.

The Touch Panel

You make selections from menus by touching the appropriate selector. Until you remove your finger from the display, the DSA indicates your potential selection by outlining that selector. You can change your potential selection by dragging your finger to the desired selector before withdrawing it.

Menu Selectors

The Utility 1 major menu has eight utility selectors in ruled boxes. The top half of each selector shows the name of the selector on a shaded background, while the bottom displays the current status on a black background.

Selectors can be normal brightness, like the ones you see in the Utility 1 major menu. Selectors that are normal brightness indicate the appropriate choices in the DSA's current state. A selector appears very dim if it cannot be selected in the current state. Bright appearance indicates a selector is already selected or being used.

The **Initialize** selector operates when you touch it and withdraw your finger:

- Step 2: Touch the **Initialize** selector in the major menu area. Then touch the **Initialize** selector displayed in the pop-up menu to verify your selection.

Pressing the **UTILITY** button and then touching the **Initialize** selectors will always set the DSA to its default state. The verification pop-up menu provides an extra step in the Initialization process to help avoid accidental initialization.

Example 1: Displaying a Waveform

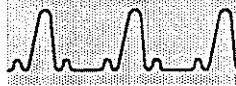

Initialize Setting Selector

Verify Selection					
Cancel			Initialize		
Calibrator	Modes	Probes	Color	Page to	Rem
				Utility 2	Wfm 1
					L4
					Main
Initialize	Time & Date	Label	Hue		Saturation
	10:30:22	Disp: On	130		55
	6-NOV-90	Mode: Man	*		%

The Utility 1 Major Menu

Connecting Signals

To view a signal, you must connect it to an input connector on the plug-in amplifier.

- Step 3: Connect the large end of the pocket signal generator to the CH 1 connector of the left plug-in amplifier. Leave the other end of the pocket signal generator unconnected.

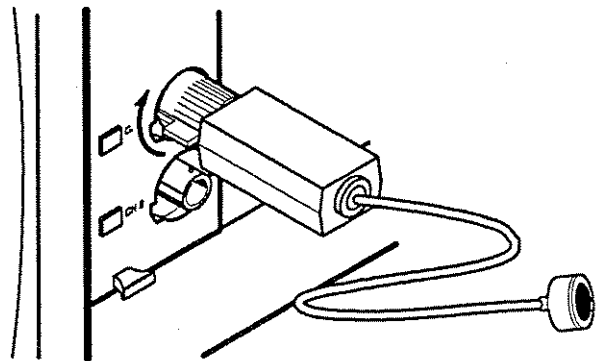

The Pocket Signal Generator Connected for Example 1

Example 1: Displaying a Waveform



Beside each plug-in amplifier input connector is a CH # (where # can be 1, 2, 3, or 4) button. Pressing the button is a quick way to display that channel. The light behind the CH # label indicates the channel is being displayed.

- Step 4: Press the CH 1 button near the input connector that you have connected to the pocket signal generator.



Look at the trigger icon (↗) to the left of the graticule. (The letter M refers to the Main time base trigger.) The word Inot! appears above the trigger icon when the DSA is not triggered. This icon always shows you the status of the trigger.

Autoset

You now see an unstable waveform on the display.

- Step 5: Press the AUTOSSET button.

AUTOSSET
Button

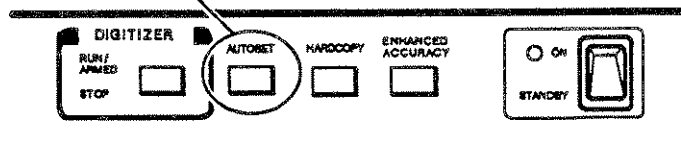

For best Autoset operation, the DSA should be in the Enhanced Accuracy Mode.

The Autoset feature quickly displays the desired data by automatically setting the horizontal, vertical, and trigger parameters to display a portion of the waveform. This display should be similar to the illustration appearing on the following page. The small arrow (↗) at the left of the waveform shows you the trigger point.

Example 1: Displaying a Waveform

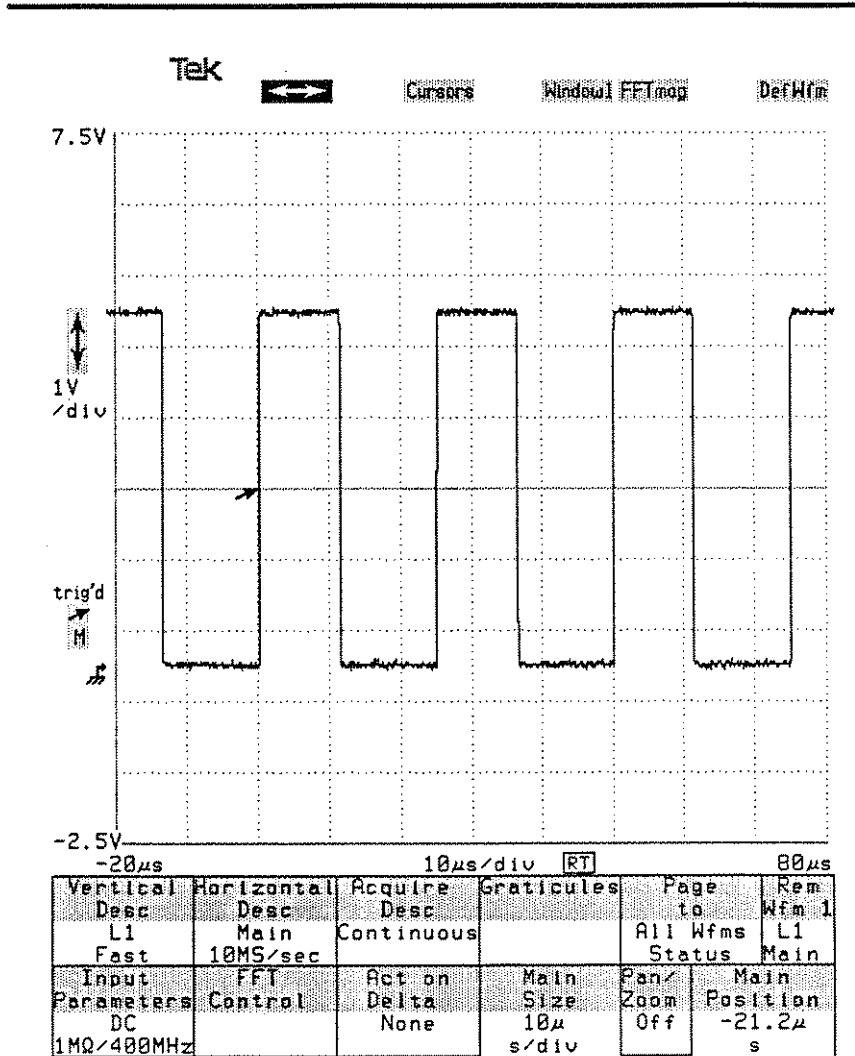

Pocket Signal Generator Signal after Pressing the AUTOSET Button

Example 1: Displaying a Waveform



The Knobs

There are two control knobs located below the display. They adjust different things at different times. The Knob menu above each knob displays the current *knob assignment*.

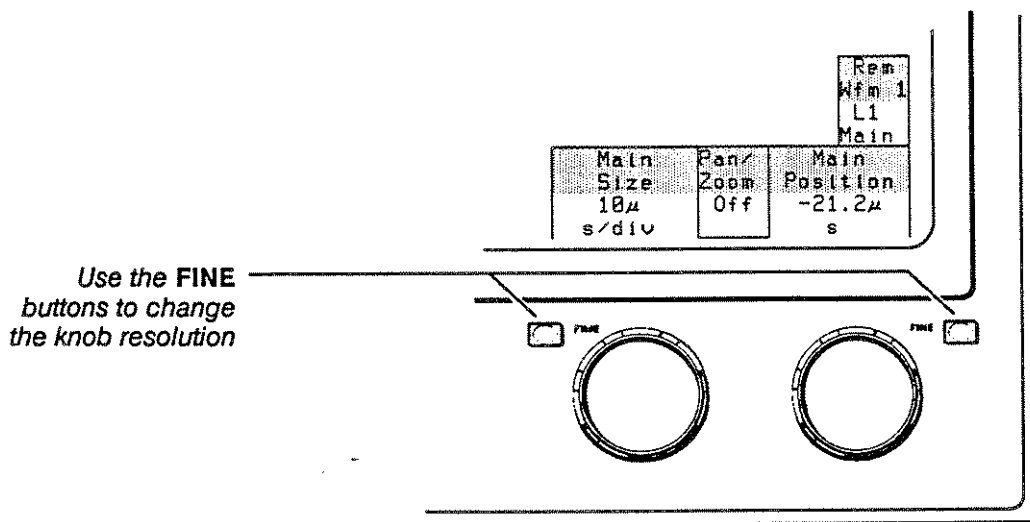

Use the **FINE** buttons to change the knob resolution

The Knobs and the Knob Menu

Two selectors on the knob menu have no bottom ruling. These always show the current knob assignment. At present they show that the left knob controls the Main Size (Main time base size per division) parameter, and the right knob Main Position (Main time base position). The bottom half of each selector shows the current value of that parameter.

Always glance at the knob labels before using the knobs.

Selectors may perform specific tasks, assign the knobs, or do both. Each knob assignment remains in effect until you change it with another selector or by pressing a major menu button.

- Step 6: Turn each knob left and right, and observe that the waveform changes. Restore the waveform to its original

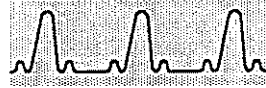

appearance by turning the knobs or by pressing the **AUTO-SET** button above the plug-in compartments.

When you turn the knobs, you will feel clicks instead of smooth motion. Each click represents a minimum change; the DSA "counts clicks" to measure knob motion. Depending on the value the knobs are assigned to, each click changes the value by some linear increment, a multiplicative factor, or the next number in a 1-2-5 sequence.

Icons

To control the vertical size and offset of a waveform, you need to reassign the knobs. You will use an icon to perform this reassignment.

Above and to the left of the graticule are several icons. These icons are always available on the display regardless of the major menu being shown. The trigger icon \rightarrow , the vertical icon \updownarrow , and the horizontal icon \leftrightarrow assign the knobs. Since the current knob assignment is horizontal (main) size and position, the horizontal icon \leftrightarrow is highlighted.

- Step 7: Touch the vertical icon \updownarrow to change the knob assignment. Observe that the icon brightens (highlights) and that the knob labels in the Knob menu change to **Vertical Size: L1** and **Vertical Offset: L1**. (The letter **L** indicates that the plug-in amplifier in use is installed in the left plug-in compartment. The right compartment is indicated with **R**; the center with **C**.)
- Step 8: Turn each knob left and right to observe the changes to the vertical characteristics of the waveform.

When all parts of the waveform are above or below the trigger indicator arrow \rightarrow , the waveform is not triggered and the display is not stable. When the waveform is not triggered, the notation **Inot! trig'd** appears above the trigger icon \rightarrow . The following illustration shows the location of the horizontal, vertical, and trigger icons in the display.

Example 1: Displaying a Waveform

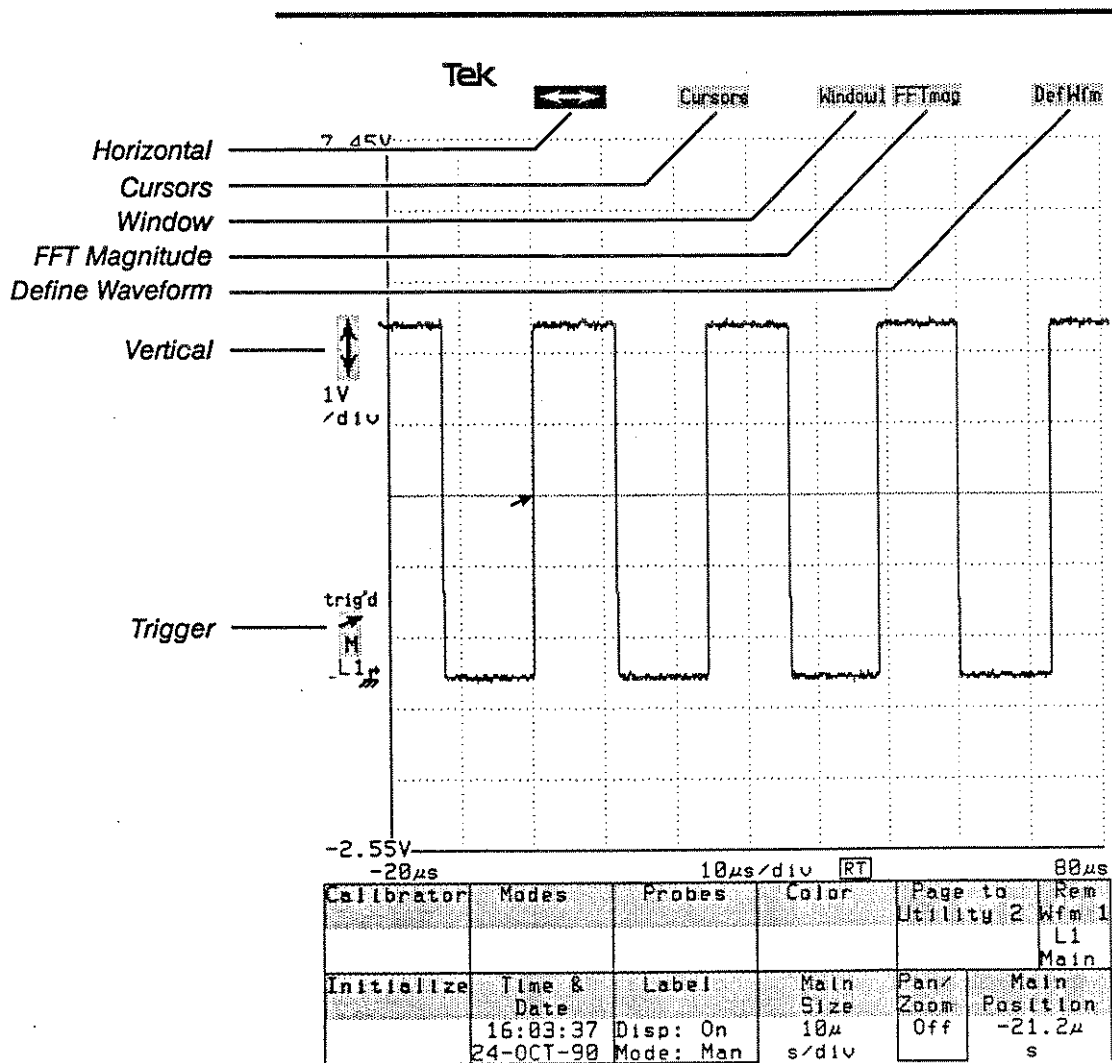

Icons

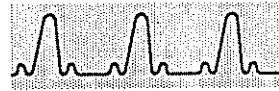

Pop-Up Menu

When you touch some menu selectors, they display pop-up menus. These menus are a temporary dialog with you, and cover up a portion of the graticule. Most pop-up menus disappear automatically when you are through with them. Some pop-up menus provide **Exit** selectors to let you remove them.

To remove a pop-up menu, touch the selector that displayed it, or touch an empty part of the graticule.

If you inadvertently display a pop-up menu and wish to remove it, touch the selector that displayed the pop-up menu. This selector is highlighted during the time that the pop-up menu is displayed. Or, you can touch a part of the graticule that has no waveforms on it.

Keypad Pop-Up Menu and Knob Resolution

The knobs can be adjusted to fine or coarse resolution using the **FINE** buttons beside the knobs, or by using the Keypad pop-up menu. This menu also allows you to enter a numeric value for a knob parameter. The Keypad pop-up menu is displayed by touching either knob label selector in the Knob menu.

- Step 9: Press the **FINE** button next to the right knob, and turn the knob.

Observe that the waveform movement is now finer than it was before. This lets you be precise in positioning the waveform.

Example 1: Displaying a Waveform

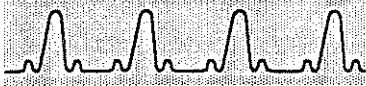

Numeric Entry & Knob Res				
Vert Size: L1		Vert Offset: L1		
Numeric Entry			Knob Res	
7	8	9	p	Coarse
4	5	6	n	Medium
1	2	3	μ	Fine
0	.	CHS	m	Set to Min 1m
Back	Enter	Set to Max		
Space				10

Knob Labels

Vertical Desc	Horizontal Desc	Acquire Desc	Graticules	Page to	Rem Wfm 1
L1	Main	Continuous		All Wfm 1	Status Main
Fast	10MS/sec				
Input Parameters	FFT Control	Act on Delta	None	Vertical Size: L1	Vertical Offset: L1
DC				1	1.9
1MQ/400MHz			V/div	L1	V

The Knob Menu and Keypad Pop-Up Menu

Look at the **Set to Min** and **Set to Max** selectors to see the valid range of any parameter.

The Keypad pop-up menu can also set a parameter to its minimum or maximum, using the **Set to Min** or **Set to Max** selectors.

- Step 10: Touch the **Vertical Size: L1** knob label to display the Keypad pop-up menu.
- Step 11: Touch the **Set to Max** selector in the Keypad pop-up menu.

Example 1: Displaying a Waveform

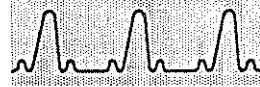

Vertical size is now the maximum (10) volts per division.

You can directly enter any value you wish using the Keypad pop-up menu.

- Step 12: Touch the **Vertical Size: L1** knob label, then touch the following selectors: **7**, **5**, **0**, and **m**. Notice the entry line being formed above the **Numeric Entry** label in the pop-up menu. (Use **Back Space** to remove incorrect entries.) Touch **Enter** to complete the entry.

Vertical size is now set to 750 mV per division.

Major Menu Knob Assignments

Each major menu assigns the knobs to different parameters. When you select a major menu, the knob assignments will be the assignments that were in effect when that major menu was last active.

Pressing a major menu button can change knob assignments.

For example, with the Waveform major menu selected, the current knob assignments are **Vertical Size: L1** and **Vertical Offset: L1**.

- Step 13: Press the **UTILITY** major menu button in the **MENUS** column.

The knob assignment changes to **Main Size** and **Main Position** because that was the last assignment made using the Utility 1 major menu.

- Step 14: Press the **WAVEFORM** major menu button in the **MENUS** column.

The knob assignment changes back to **Vertical Size: L1** and **Vertical Offset: L1**.

Example 1: Displaying a Waveform



Example 2: Managing Multiple Waveforms



NOTE
Never install or remove a plug-in unit while the DSA power is on.
Read the Operator Overview section for information about installing your DSA.

This example demonstrates multiple waveforms and graticules on the display. It also shows how to select and manage waveforms.

For this example you will need a DSA 601A or DSA 602A with a multichannel plug-in amplifier installed in the left compartment. You will also need the pocket signal generator.

- Step 1: Initialize the DSA: Press the **UTILITY** button in the **MENUS** column and touch **Initialize**. Touch **Initialize** in the pop-up menu. The Initialize pop-up menu provides a second step in the initialization process. This extra step helps prevent accidental initialization.
- Step 2: Connect the large end of the pocket signal generator to the **CH 1** connector of the left plug-in amplifier.

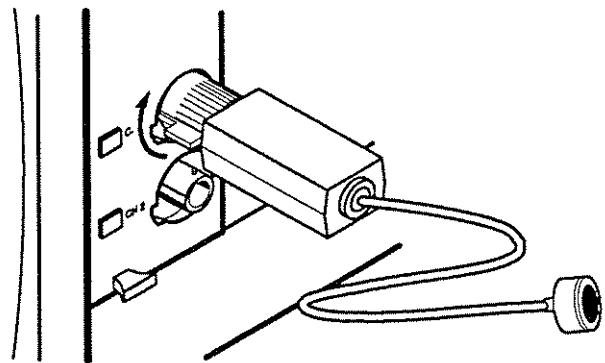

Initial Connection of the Pocket Signal Generator for Example 2

- Step 3: Press the **CH 1** button on the left plug-in amplifier.
- Step 4: Press the **AUTOSET** button.

Example 2: Managing Multiple Waveforms

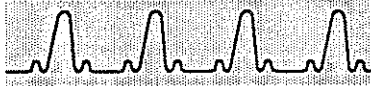

Adding a second waveform is similar to displaying the first waveform.

- Step 5: Connect the free end of the pocket signal generator to the CH 2 connector of the left plug-in amplifier.
-

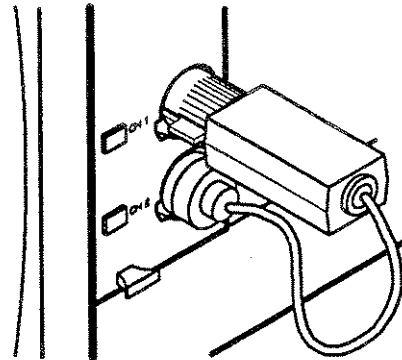

- Final Connection of the Pocket Signal Generator for Example 2

- Step 6: Press the CH 2 button on the left plug-in amplifier. A second, noisier waveform is displayed.

Example 2: Managing Multiple Waveforms

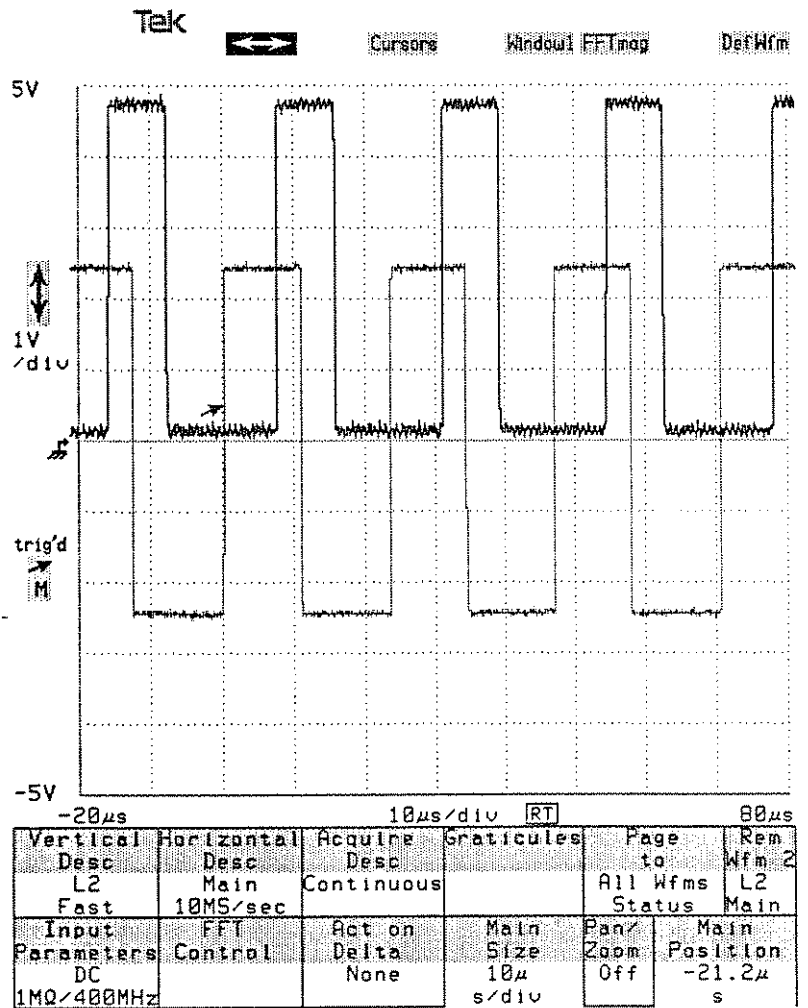

Graticule with Two Waveforms

Example 2: Managing Multiple Waveforms

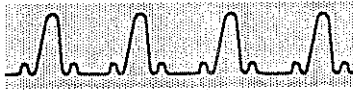

You should be aware of several important points about this display:

- Both waveforms share the Main time base, and so both waveforms are displayed within the same span of time. The horizontal axis labels apply to both waveforms. This may not hold true for the vertical axis.
- Each waveform is displayed as a different color. (See Color Display in the *User Reference* for more information about changing colors in the display.) The selected waveform is highlighted (brightened).
- The Horizontal and Vertical axes are the color of the selected waveform. The DSA can display up to eight waveforms at once, but there is always one selected waveform. Most menu selectors, the knobs, the status displays, and Autoset apply to or operate on the selected waveform.
- The channel labels on the left plug-in amplifier are lighted to show that the two channels are being displayed.

Selecting Waveforms by Touch

You touch a waveform to make it the selected waveform. An outline box in the display indicates your potential selection; if only one waveform passes through the outlined area, it will become the selected waveform when you remove your finger from the display. If several waveforms pass through the outlined area, repeatedly touching the same area will select the waveforms in succession.

- Step 7: Touch the waveforms to change selections. Try touching an area with one waveform, and an area where both waveforms appear.

The Waveform major menu shows the status of the selected waveform.

- Step 8: Look at (don't touch) the Vertical Desc selector.

The waveform vertical description is also called the waveform expression.

Example 2: Managing Multiple Waveforms



The **Vertical Desc** selector shows the description of the selected waveform.

Vertical Desc	Horizontal Desc	Acquire Desc	Graticules	Page to	Rem Wfm #
L2 Fast	Main 10MS/sec	Continuous		All Wfms Status	L2 Main
Input Parameters DC 1MΩ/400MHz	FFI Control	Act on Delta None	Main Size 10μ s/div	Pan/Zoom Off	Main Position -21.2μ s

The Waveform Major Menu with the Knob Menu

If the selected waveform displays channel 1 of the left plug-in amplifier, then the **Vertical Desc** selector will show **L1**. (**Fast** is a waveform parameter that is described in Example 3.) Channels can be combined to form a single waveform, for example **L1 + L2** (Example 3 demonstrates combining channels).

The **Rem Wfm #** selector in the Knob menu shows the description of the selected waveform. (It also indicates that the Main time base is being used.) This selector is always on the display, unlike the **Vertical Desc** selector that is a part of the Waveform major menu. You can always look at the **Rem Wfm #** selector to see the description and time base of the selected waveform.

The number (#) in the **Rem Wfm #** selector is assigned by the DSA when the waveform is created. Because up to eight waveforms can be displayed, waveform numbers (#) range from 1 through 8. This selector always shows the number of the selected waveform.

- Step 9: Select each waveform by touching it, and observe the **Vertical Desc** and **Rem Wfm #** selectors.

Example 2: Managing Multiple Waveforms

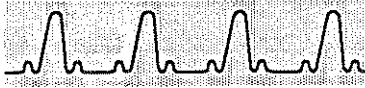

Selecting Waveforms Using the All Waveforms Status Menu

Another method of selecting waveforms presents information about all displayed waveforms. The Waveform major menu has an alternate All Waveforms Status menu. The **Page to All Wfms Status** menu selector of the standard Waveform major menu displays this alternative menu. The **WAVEFORM** button is lighted when either alternative is displayed.

- Step 10: Touch the **Page to All Wfms Menu** selector in the major menu to see the All Waveforms Status menu.

1:L1 Main 1V 10µs	2:L2 Main 1V 10µs		Show Full Wfm Desc	Page to Single Waveform

The All Waveforms Status Menu

The All Waveforms Status menu has a **Page to Single Waveform** selector to return you to the Waveform major menu—or just press the **WAVEFORM** major menu button again.

The All Waveforms Status menu presents one selector for each displayed waveform (up to eight waveforms). These selectors show status information about the waveform they represent. The selector for the selected waveform is highlighted. You can make any waveform the selected waveform by touching its selector. This highlights the new waveform and the representative selector in the All Waveforms Status Menu.

- Step 11: Touch the waveform selector that is not highlighted in the All Waveforms Status menu. Notice that it becomes highlighted and its waveform is highlighted on the graticule.



The All Waveforms Status menu has a **Show Full Wfm Desc** selector that shows a more detailed description of all the waveforms displayed on the screen.

- Step 12:** Touch the **Show Full Wfm Desc** selector. A pop-up menu appears which shows the waveform description for each displayed waveform. The selected waveform is highlighted. Touch **Show Full Wfm Desc** again to return to the All Waveforms Status menu. Finish by touching the **1:L1** selector to select waveform 1, and then touching the **Page to Single Waveform** selector.

Labeling Waveforms

You can label displayed waveforms to help you keep track of them. You can specify a label of up to 10 characters for each waveform. The waveform label moves with the waveform as the signal changes. You can change the position of the label relative to the waveform. The **Label** pop-up menu in the Utility 1 major menu establishes and controls labels.

- Step 13:** Press the **UTILITY** major menu button, and touch the **Label** selector.

The **Display** selector of the **Label** pop-up menu turns on or off the display of all waveform labels.

- Step 14:** If the **Display** selector shows Off, touch it to set it to On.

When you touch the selector for a waveform, you choose the waveform for which you are going to type a label. This selector shows the label characters as you type.

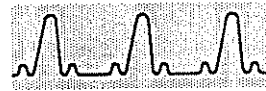

- Step 15: If it is not already highlighted, touch the **Displayed Waveforms** selector.

- Step 16: Touch the selector for waveform 1 (the selector with the L1 vertical description).

The lower portion of this pop-up menu displays selectors that allow you to type a label. The selectors along the very bottom allow you to change the set of available characters to **Upper Case**, **Lower Case**, **Graphics**, **Greek**, or **Numbers** (which include most punctuation). There is also a selector for **Other**, which allows you to type in additional symbols. **Back Space** lets you correct errors. **Erase** removes all label characters. **Exit** removes the pop-up menu.

- Step 17: Type a label of up to 10 characters. You might label the waveform "Channel 1" or use your name. (The label you enter appears in the **Wfm 1** selector as you touch each character.) Finish by touching the **Exit** selector.

Once a label is established, it moves with the waveform. You can control the position of the label relative to the waveform. The **Position** selector of the **Label** pop-up menu assigns the knobs to set the position of the label.

- Step 18: Touch the **Label** selector in the major menu area, and touch the **Position** selector in the **Label** pop-up menu. Use the knobs to position the label horizontally and vertically.

You can attach a label to any specified point on the waveform. You specify the point for the label by adjusting the **Horizontal** and **Vertical** positions of the label using the knobs.

Note that although the horizontal position is indicated in units of time, the label is not attached to any particular time. The label stays at the same horizontal screen location when the **Horizontal Size**, **Horizontal Position**, or **Record Length** are adjusted because the label is actually attached at a certain percentage of the waveform record.

Example 2: Managing Multiple Waveforms

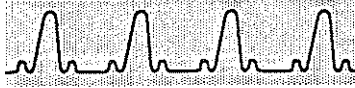

If the Record Length is 4, 8, 16, or 32 K, however, the label changes position on the graticule in order to maintain the same position within the waveform record.

In general, the label is attached to a point in the waveform record, not to the waveform itself.

Waveform labels will always stay on the graticule. If the position or the movement of the waveform would take a label off the display, the edge of the graticule limits the movement of the label.

Displaying Dual Graticules

The Graticules selector can create a dual-graticule display. You can place waveforms on either graticule.

- Step 19: Press the **WAVEFORM** button, then touch the **Graticules** selector. Touch **Create Second Graticule**.

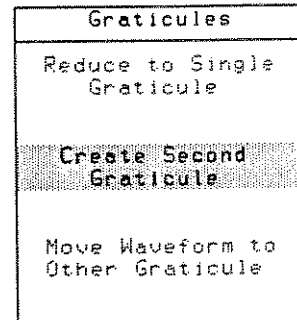

Vertical Desc	Horizontal Desc	Acquire Desc	Graticules	Page to	Rem. Wfm 2
L2	Main	Continuous		All Wfms Status	L2 Main
Fast	10MS/sec				
Input Parameters	FFT Control	Act on Delta	Main Size	Fan/Zoom	Main Position
DC		None	10μ s/div	Off	-21.2μ s
1MΩ/400MHz					

The Graticules Pop-Up Menu

Example 2: Managing Multiple Waveforms

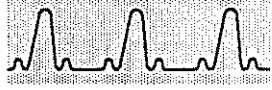

The horizontal (↔) and vertical (↕) icons appear on the graticule of the selected waveform. (This is called the active graticule.) If you select a waveform on the other graticule, it will make that graticule the active graticule.

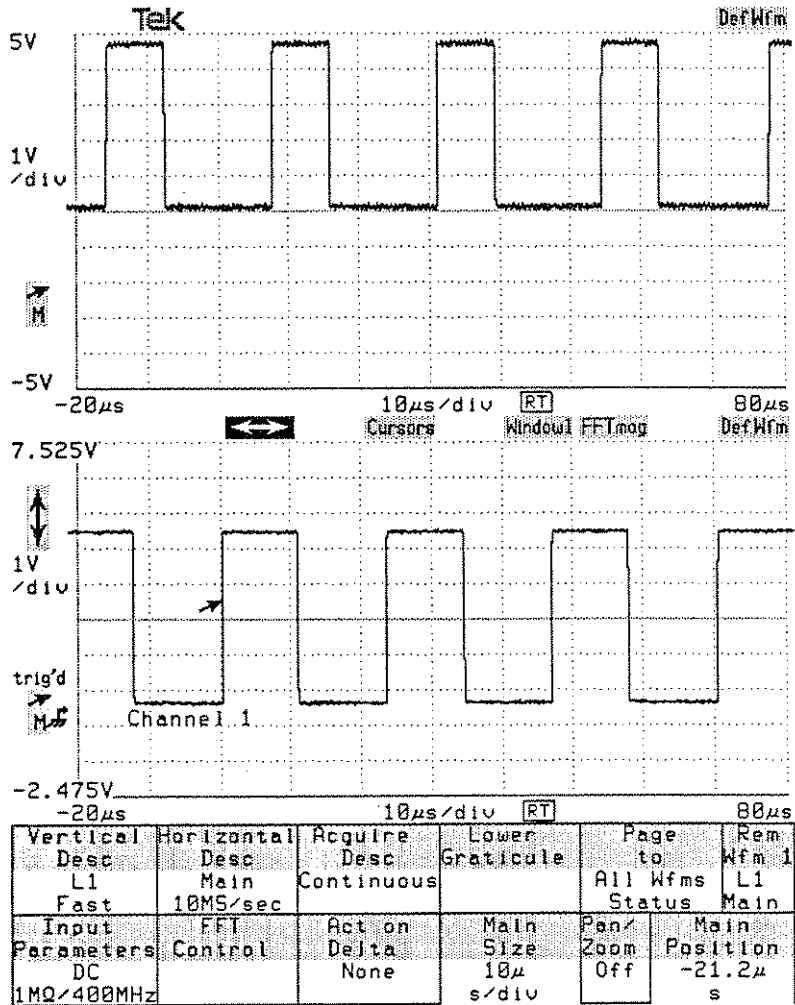

A Dual-Graticule Display

Example 2: Managing Multiple Waveforms

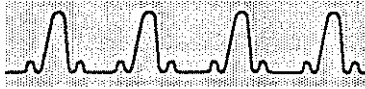

Clear wfm restarts the acquisition and clears the waveform memory. To do this, stop the digitizer, clear all waveforms (waveforms disappear but channels and descriptions remain valid) and restart the digitizer.

- Step 20: Touch the **Lower Graticule** selector in the **Waveform** major menu. Touch **Move Waveform to Other Graticule**; the selected waveform moves to the other graticule.
- Step 21: Touch the **Upper Graticule** selector of the major menu. Touch **Reduce to Single Graticule**.

Removing Waveforms

Use the **Knob** menu to remove waveforms from the display.

- Step 22: Touch the **Rem Wfm #** selector, and then touch **Remove Wfm #** in the pop-up menu.

This will remove one of your waveforms, leaving one on the display. You could remove the remaining waveform using **Remove Wfm #** again. You can also remove the waveform by pressing the **CH #** button that is lighted on the plug-in amplifier.

The light beside a plug-in channel indicates that the channel is displayed in at least one waveform on the display. If the light is on, pressing the channel button will remove *all* waveforms displaying that channel.

- Step 23: Press the **CH #** button beside the lighted plug-in channel to remove the remaining waveform.



Example 3: Defining Complex Waveforms



NOTE

Never install or remove a plug-in unit while the DSA power is on.

Read the Operator Overview section for information about installing your DSA.

This example shows how you can create waveforms that combine signals from more than one channel.

For this example you will need a DSA 601A or DSA 602A with a multichannel plug-in amplifier installed in the left compartment. You will also need the pocket signal generator.

- Step 1: Initialize the DSA: Press the **UTILITY** button in the **MENUS** column and touch **Initialize**. Touch **Initialize** in the pop-up menu.
- Step 2: Connect the large end of the pocket signal generator to the **CH 1** connector of the left plug-in amplifier. Connect the free end of the pocket signal generator to the **CH 2** connector of the left plug-in amplifier.

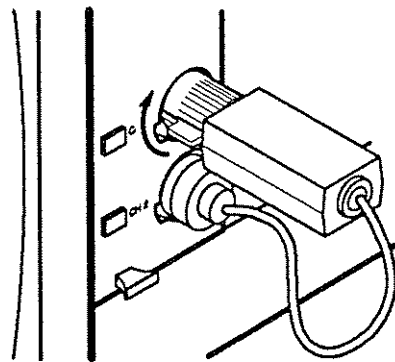

The Pocket Signal Generator Connected for Example 3

Example 3: Defining Complex Waveforms

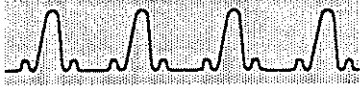

This example uses auto level triggering, which adjusts the trigger level automatically to match the signal. The default trigger mode is auto trigger, not auto level trigger. The Trigger major menu sets the trigger mode to Auto Level.

					Trigger Mode	
					Auto Level	
					Auto	
					Normal	
					Mode	
Trigger Select	Source Desc	Level	Time Holdoff	Auto	Rem Wfm	
Main	L1	0V	2 μ s			
Coupling	Slope	Timer t1	Main Trig Level		Main Time Holdoff	
DC	+	2ns 1ms	0V		2 μ s	

The Mode Pop-Up Menu

- Step 3: Press the **TRIGGER** button in the **MENUS** column, and touch the **Mode** selector in the Trigger major menu. Touch the **Auto Level** selector in the pop-up menu.

Example 3: Defining Complex Waveforms

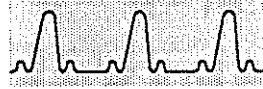

- Step 4: Press the **CH 1** button on the left plug-in amplifier.
- Step 5: Touch the horizontal (\leftrightarrow) icon and turn the left knob to adjust the horizontal size to $10 \mu\text{s}/\text{div}$. *Do not use the **AUTOSET** button!*
- Step 6: Touch the vertical icon (\updownarrow), and use the left knob to adjust the vertical size to $2 \text{ V}/\text{div}$. Use the right knob to move the waveform to the top portion of the graticule. *Make sure all parts of the waveform remain on the graticule.*
- Step 7: Press the **CH 2** button on the left plug-in amplifier. Use the left knob to adjust the vertical size of the new waveform to $2 \text{ V}/\text{div}$. Use the right knob to move the waveform to the bottom portion of the graticule. *Make sure all parts of the waveform remain on the graticule.*

Waveform Descriptions

The next step is to display a waveform that represents the sum of the two signals. Up to now, you have pressed the channel buttons on the plug-in amplifier to display waveforms. That is a shortcut method limited to single-channel waveforms.

The Define Waveform (**DefWfm**) icon defines and creates new waveforms. It is located above the upper right corner of each graticule. Touching the icon presents a pop-up menu that covers the full display. The same pop-up menu is presented when you touch the **Vertical Desc** selector of the Waveform major menu, but the operation is different. The **Vertical Desc** menu selector allows you to view and change the description of an existing waveform; the **DefWfm** icon creates a new waveform.

- Step 8: Touch the **DefWfm** icon.

The **Vertical Desc** selector and the **DefWfm** icon operate differently, although they both display the same pop-up menu.

If you touch the **DefWfm** icon by accident, you can touch the **Cancel** selector to get out of the pop-up menu.

Example 3: Defining Complex Waveforms



Vertical Description					
L1	C1	R	7	8	9 +
L2	C2		4	5	6 -
L3	C3		1	2	3 *
L4	C4		0	.	EEX /
Waveform Functions		Abs()	Avg()	Diff()	Env()
Stored Waveforms	RAM DISK	Exp()	Filter()	Intg()	Intp()
Adjustable Constants		Ln()	Log()	PAGE↑	PAGE↓
Enter Desc	()	,	Back Space		Cancel
Vertical Desc	Horizontal Desc	Acquire Desc	Graticules	Page to	Rem Wfm 2
L2	Main	Continuous		All Wfms	L2
Fast	10MS/sec			Status	Main
Input Parameters	FFT Control	Act on Delta	Main Size	Pan/Zoom	Main Position
DC	dBm	None	10μ	Off	-1.2μ
1MQ/300MHZ	Rectang		s/div		s

The DefWfm Pop-Up Menu

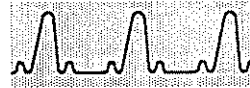

You don't need to display the source waveforms to create a complex waveform.

The selectors in the **DefWfm** pop-up menu are keystrokes for building a waveform description. The keystroke description is shown at the top of the menu. The following selectors are available:

- **Channel Selectors** specify a channel of an installed plug-in amplifier. Only the channel numbers of installed plug-in amplifiers are displayed.
- **Numeric Pad** allows entry of numeric constants and arithmetic operators of addition, subtraction, multiplication, and division.
- **Waveform Functions** specify functions such as logarithms, differentiation, and averaging.
- **Stored Waveforms** specify a previously stored waveform.
- **Adjustable Constants** allow you to vary the values of scalar variables in waveform definitions or function argument lists.
- **Syntax** includes parentheses, **Back Space** (which can be used for successive entries), and **Enter Desc** (which enters your completed description, removes the pop-up menu, and creates the waveform).
- **Cancel** removes the pop-up menu and discards any keystrokes you have entered.

You want to enter a sum description $L1 + L2$.

- Step 9:** Touch **L1**, **+**, **L2**, and **Enter Desc**, all in the pop-up menu.

When you create the new waveform, it is the selected waveform. The waveform description, $L1 + L2$, appears in the **Vertical Desc** selector of the **Waveform** major menu, and in the **Rem Wfm 3** selector in the **Knob** menu.

Example 3: Defining Complex Waveforms



Unless all component waveforms have the same vertical size, a complex waveform will have undefined vertical units.

Vertical Adjustment of Complex Waveforms

You can change the vertical size and offset of only one input channel at a time, even if the selected waveform represents several inputs.

- Step 10: Touch the top waveform to select it.
- Step 11: Touch the vertical icon (\updownarrow) if it is not already highlighted. Turn the right knob counterclockwise two or three clicks.

As the selected L1 waveform moves down, the complex L1 + L2 waveform also moves down.

- Step 12: Set the right knob to fine resolution by pressing the **FINE** button next to the knob.
- Step 13: Touch the bottom waveform to select it. Use the right knob to move the bottom edge of this waveform partially off the display, and then completely off the display.

When the bottom edge of the bottom waveform is partially off the graticule, the complex L1 + L2 waveform becomes ragged. This aberration is caused by a component signal being off the graticule. The selected waveform is off the bottom edge of the display, and this means that the complex waveform that depends on it is affected as well.

- Step 14: Use the right knob to move the L2 waveform back onto the graticule completely.

In the last few steps, you have moved the complex waveform by selecting and moving one of the component waveforms. Since you have the component waveforms on the display this is easy to do. Usually, when you display a complex waveform, you will not be displaying all the waveforms that represent the individual channel signals.

Example 3: Defining Complex Waveforms

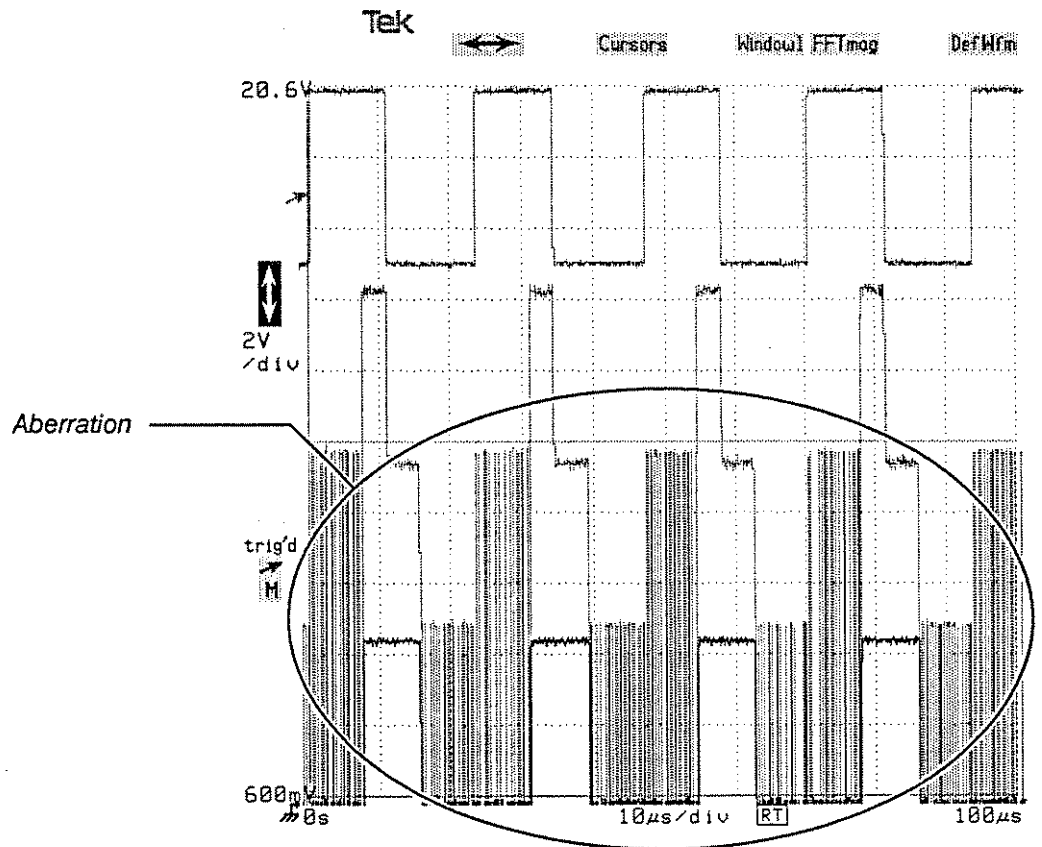
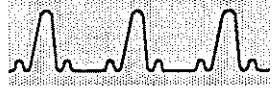

Complex Waveform Aberration Caused by an Off-Graticule Component

You can select this complex waveform and move it with the knobs. However, when you do this you are actually moving only one component input channel of the complex waveform.

Example 3: Defining Complex Waveforms



When the knobs are set to Vertical Size and Vertical Offset, the menu between the knob selectors becomes **Chan Sel**. **Chan Sel** enables choosing input channels. Repeatedly touching this selector lets you choose from all input channels making up the waveform.

Graticules	Page to	Rem Wfm 3
	All Wfms	L1+L2
	Status	Main
Vertical Size: L1	Chan Sel	Vertical Offset: L2
2	L2	10.15
V/div		V

Chan Sel Selector

The Chan Sel Selector in the Knob Menu

- Step 15: Touch the middle (L1 + L2) waveform to select it.
- Step 16: Touch the **Chan Sel** until it shows **L2**. Use the right knob to position the selected waveform up and down.

As you move the selected complex waveform up and down, the L2 waveform moves up and down also. This operates the same as if the L2 waveform were selected.

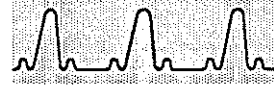

Calculated Waveforms

If your complex waveform is a calculated waveform, you can move it vertically using the knobs without changing the offset of any component channel. The complex waveform you have created and moved in this example is not a calculated waveform; this is indicated by the notation of **Fast** in the **Vertical Desc** selector. Calculated waveforms will show **High Prec** in the **Vertical Desc** selector.

Fast waveforms use integer arithmetic to favor processing speed over accuracy. Calculated waveforms use floating-point arithmetic for maximum accuracy.

You can specify that all complex waveforms you create in the future will be calculated waveforms: Press the **UTILITY** button, and touch the **Modes** selector. In the pop-up menu, touch the **Waveform Scaling** selector until it shows **Forced**. This change does not affect any waveform already on the screen, but it will cause all complex waveforms you create in the future to be calculated waveforms and will cause single channel traces to be created in floating point mode.

For now, leave **Waveform Scaling** set to **Optional**.

The remainder of this example is performed without multiple waveforms on the display.

- Step 17: Select and remove each of the simple waveforms that represent a single input channel. With a simple waveform selected, press the **Rem Wfm #** selector. Remove the remaining simple waveform in the same manner.

Example 3: Defining Complex Waveforms



Windows

A window is a waveform that represents a horizontally magnified portion of another waveform. A window waveform is sampled separately from the main waveform it is magnifying. The **Window1** icon above the graticule creates windows.

- Step 18: Touch the **Window1** icon.

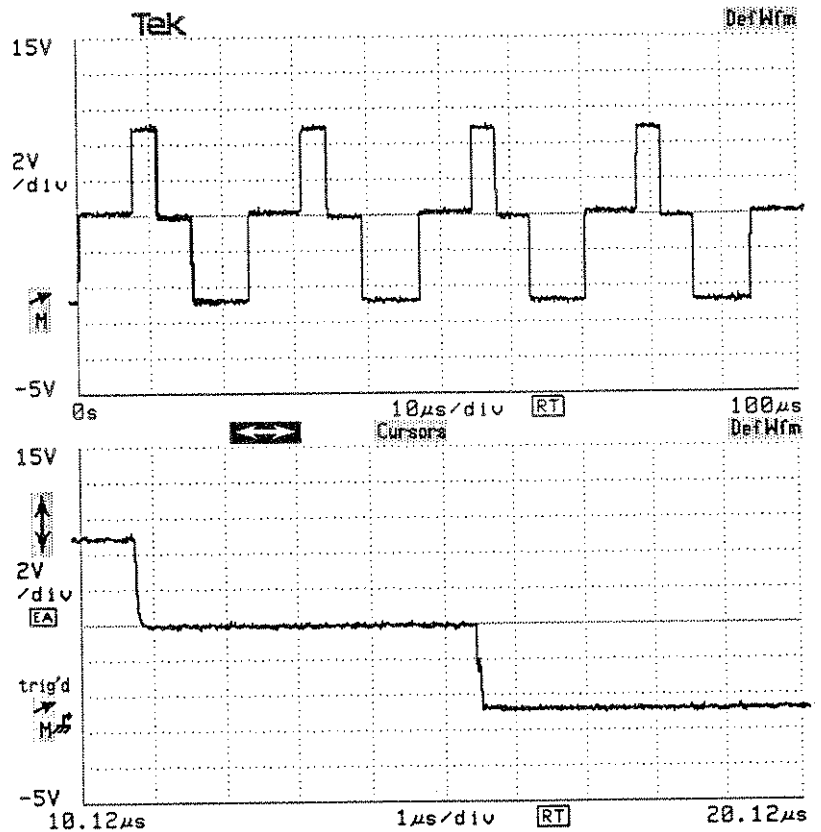
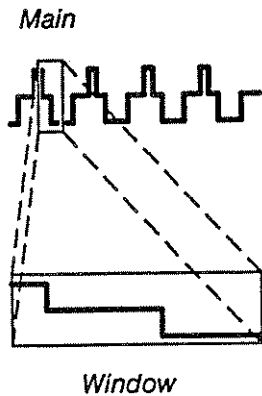

A Window Waveform Display



Window waveforms can be moved from one graticule to another, or combined into a single graticule display.

The DSA automatically adds a second graticule with the window waveform. The main waveform is placed on the top graticule, and its highlighted portion shows what the window waveform is displaying. The vertical description of the window waveform is the same as the main waveform that it expands.

In Example 2, when you created a dual-graticule display, both waveforms shared the same time base. Here the two waveforms have different time bases. This can be seen in the graticule labels.

- Step 19: Touch the horizontal icon (↔) and turn the right **Window1 Position** knob left and right. The highlighted portion of the main waveform moves and the window waveform tracks it.
- Step 20: Turn the left **Window Size** knob left and right one click at a time. The size of the highlighted area on the main waveform changes and the window waveform reflects that change.
- Step 21: Touch the main waveform on the top graticule to select it. The icons move to the top graticule. Turn the left knob counterclockwise one, and then two, clicks. Observe that resizing the main waveform does not affect the window waveform.

You can add another window waveform that is based on the original main waveform, but you cannot take a window of a window. When you made the main waveform the selected one, a **Window2** icon appeared, which allows you to create a second window waveform.

- Step 22: Touch the **Window2** icon above the top graticule. The second window waveform is created, with its own highlighted portion on the main waveform. Both window waveforms always have the same horizontal scale.

The two window waveforms are placed on top of each other. You can separate them vertically. For window waveforms, the Chan

Example 3: Defining Complex Waveforms

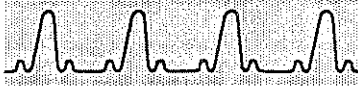

Sel selector includes a **Trc Sep Md** (trace separation mode) setting, which causes the knobs to move the selected window waveform vertically. This moves only the selected waveform.

Lower	Page	Rem
Graticule	to	Wfm 2
	All Wfms	L1+L2
	Status	Wind.
Trace	Chan	Trace
Separation	Sel S	Separation
0	Trc	0
div	SepMd	div

Chan Sel Selector

The Chan Sel Selector in the Knob Menu

- Step 23: Touch the Vertical icon (↕), then touch the Chan Sel selector in the Knob menu repeatedly until it displays **Trc Sep Md**.
- Step 24: Turn either knob and observe that the selected window waveform moves up or down.



Example 4: Using Signal Processing



NOTE

Never install or remove a plug-in unit while the DSA power is on.
Read the Operator Overview section for information about installing your DSA.

This example demonstrates several ways that the DSA can process your signals to provide more meaningful displays.

For this example you will need a DSA 601A or DSA 602A with a multichannel plug-in amplifier installed in the left compartment. You will also need the pocket signal generator.

- Step 1: Initialize the DSA: Press the **UTILITY** button in the **MENUS** column and touch **Initialize**. Touch **Initialize** in the pop-up menu.
- Step 2: Attach the large end of the pocket signal generator to the **CH 1** connector of the left plug-in amplifier. Attach the free end of the pocket signal generator to the **CH 2** connector of the left plug-in amplifier.

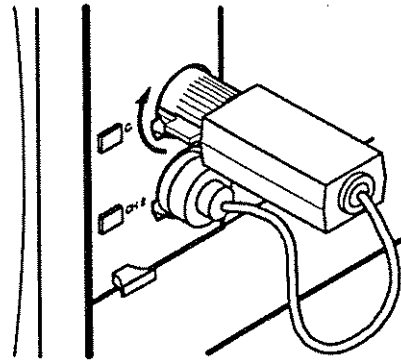

The Pocket Signal Generator Connected for Example 4

- Step 3: Press the **CH 2** button on the left plug-in amplifier. *Do not press the CH 1 button.*
- Step 4: Use the left knob to set the **Main Size** to 20 μ s/div.
- Step 5: Touch the vertical icon (\updownarrow) and use the right knob to move the waveform approximately to the middle of the display.

Example 4: Using Signal Processing



- Step 6: Press the trigger icon (). Use the left knob to move the trigger arrow up and down until you find a point where the triggering is unstable. The trigger arrow should be near the vertical center of the waveform.

The unstable triggering of this waveform is caused by a condition in the signal. During the course of this example, you will determine the cause of the trigger instability.



The Signal with Trigger Instability

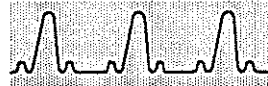

Trigger Coupling

The selectors in the Trigger major menu let you control the DSA's triggering parameters. In Example 3, you used the Mode pop-up menu to set the trigger mode to Auto Level. In this example, you will use the Coupling pop-up menu to change the trigger coupling.

- Step 7: Touch the TRIGGER button in the MENUS column to display the Trigger major menu.
- Step 8: Touch the Coupling selector in the major menu.

The Coupling pop-up menu has a selector for each trigger coupling option; in addition to AC and DC coupling, you can set the trigger coupling to reject low or high frequencies, or to reject noise.

Main Trigger Coupling					
AC		DC			
AC Low Freq Reject					
AC High Freq Reject		DC High Freq Reject			
AC Noise Reject		DC Noise Reject			
Trigger Select	Source Desc	Level	Time Holdoff	Mode	Rem Wfm 1
Main	L2	2.35V	2 μ s	Auto	L2 Main
Coupling	Slope	Timer t1	Main Trig Level	Main Trig	Main Time Holdoff
DC	+	2ns 1ms	2.35V		2 μ s

The Coupling Pop-Up Menu

Example 4: Using Signal Processing



- Step 9: Touch the **DC High Freq Reject** selector to change the trigger coupling to reject high frequencies in the trigger signal.

The triggering of the displayed waveform is now stable. This implies that the trigger instability has something to do with high-frequency noise or a high-frequency aberration.

- Step 10: Reset the trigger coupling to DC: touch the **Coupling** selector, then touch the **DC** selector in the pop-up menu.

Infinite Persistence Mode

Another method for observing waveform noise uses the Infinite Persistence feature, available through the **Horizontal Desc** pop-up menu. This leaves earlier waveform data on the display as new data is added, to build a history of displayed points.

- Step 11: Touch the horizontal icon (\leftrightarrow) and use the left knob to set the **Main Size** (the horizontal time/div) to 50 ns/div. Use the right knob to move the waveform to the right, until the trigger point arrow is two divisions from the left edge of the graticule.
- Step 12: Press the **WAVEFORM** button, and touch the **Horizontal Desc** selector in the Waveform major menu. The Horizontal Description pop-up menu appears.

Example 4: Using Signal Processing

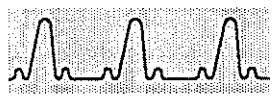
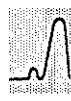

Horizontal Description					
Acquiring Timebase: Main Main Sample Interval: 500ns/point RT Window Sample Interval: 50ns/point					
Main Record Length 1024 points			Window Record Length 1024 points		
Display Persistence Normal Infinite Variable Persist Time 1s			Digitizer Interleave 165/sec Realtime Disabled		
XY Display Mode: X=Displayed Waveform					
Normal YT		Wfm 1 L2 Main			
Displayed Waveforms					
Stored Waveforms RAM DISK					
Vertical Desc	Horizontal Desc	Acquire Desc	Graticules	Page to	Rem Wfm 1
L2 Fast	Main 2MS/sec	Continuous		All Wfms Status	L2 Main
Input Parameters	FFT Control	Act on Delta	Main Trig Level	Main Trig	Main Time Holdoff
DC 1MQ/300MHZ	dBm Rectang	None	200mV		2µs

The Horizontal Desc Pop-Up Menu

- Step 13: Press the Infinite selector in the Horizontal Desc pop-up menu.

Example 4: Using Signal Processing

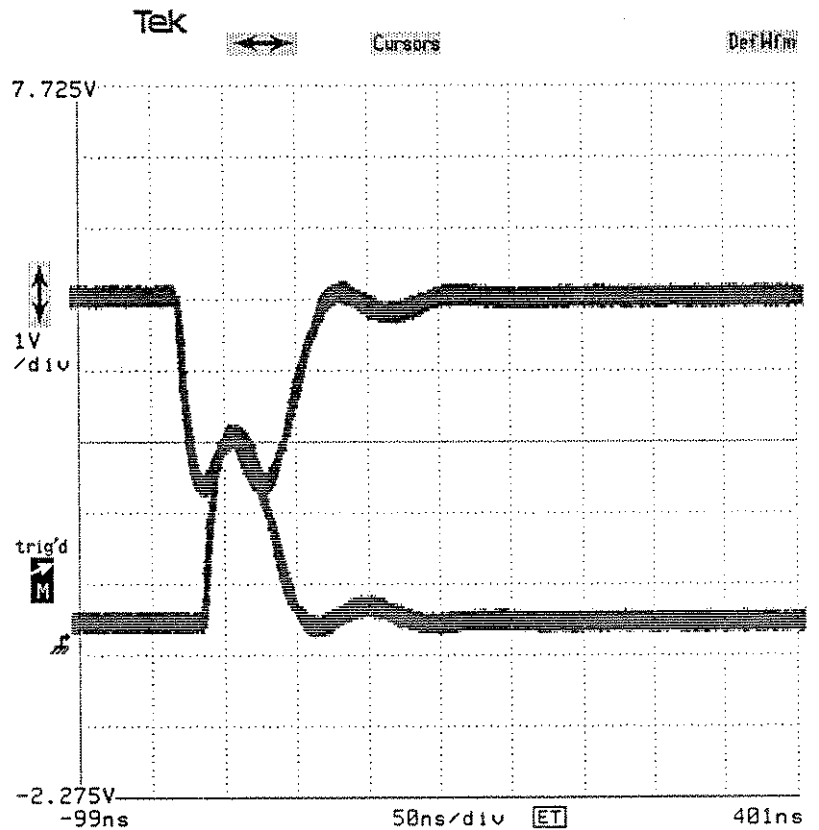
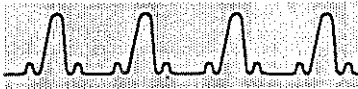

An Infinite Persistence Waveform

The broad waveform bands indicate two different waveform paths. The triggering is unstable because valid trigger events, in this case positive slopes through the trigger level, occur at two different places on the waveform.

Adjusting the trigger level above or below the unstable area will stabilize the triggering.

- Step 14: Touch the trigger icon () at the left of the graticule to assign the knobs to main trigger level and holdoff.

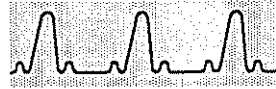

Turn the left knob left and right to adjust the trigger level below, and then above, the unstable area. Leave the trigger level at a point where stable triggering occurs.

- Step 15: Touch the horizontal icon (\leftrightarrow) above the graticule to assign the knobs to main size and position. Turn the left knob counterclockwise to set the **Main Size** to 20 $\mu\text{s}/\text{div}$.

At each knob click, the waveform is cleared and data accumulation begins. This clearing of waveform data prevents inappropriate data from being displayed with an infinite persistence waveform.

- Step 16: Touch **Horizontal Desc** in the major menu and **Normal** in the pop-up menu to turn off infinite persistence display of data.

Averaging and Enveloping

An averaged waveform is one where several waveform records (successive waveform acquisitions) are combined. Each displayed point of the resulting waveform is an average of all the corresponding points from the individual records. This can reduce the apparent noise of the waveform.

Enveloping is similar in that several waveform records are collected. Instead of a single-point average, the envelope displays the maximum and minimum excursions of the samples. This shows the accumulated variation of the signal.

The **DefWfm** pop-up menu has **Avg(** and **Env(** selectors. Typically, an averaged waveform description:

Avg(L1 + L2)

would be entered with the selectors:

DefWfm, Avg(, L1, +, L2,), and Enter Desc.

Example 4: Using Signal Processing

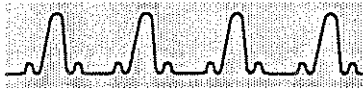

A shortcut is available to apply averaging or enveloping to an existing waveform description. The Waveform major menu's **Acquire Desc** pop-up menu provides **Average N** and **Envelope N** selectors to set these functions on and off.

- Step 17: Touch the **Acquire Desc** selector in the major menu.
- Step 18: Touch the **Average N** selector in the pop-up menu, and then touch **Acquire Desc** in the major menu to remove the pop-up menu.

The averaged waveform now appears less noisy. While the individual waveforms are acquired, the current record number is displayed in the **Acquire Desc** selector. The waveform description in the **Vertical Desc** selector is **Avg(L2)**, showing that averaging has been added to your earlier description.

You can change the number of records in an average from the default value of 32.

- Step 19: Touch **Acquire Desc** in the major menu and then touch **Set AvgN** in the pop-up menu. Adjust the left knob to change the average count. Touch the **Acquire Desc** selector to remove the pop-up menu.

Each time you click the knob, a new average begins. If you want the DSA to stop acquiring data after the required number of samples, you can use the **Average Complete** selector in the **Stop Acquisition After** section of the menu.

- Step 20: Touch **Acquire Desc** in the major menu and **Average Complete** in the pop-up menu. Touch **Acquire Desc** to remove the pop-up menu.

The DSA stops acquiring data when the average is complete, leaving a stable display.

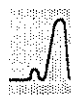

Acquire Description		Stop Acquire After
Set %	99%	% Fill Complete
Set AvgN Average N	32 Off	Average Complete
Set EnvN Envelope N	32 Off	Envelope Complete
Trigger Select	Main	Single Trigger
Trigger Select	Window	Single Sequence
Set Rep (Trigger N)	1	Rep Trig Complete
Create Template		Delta
Page To Autostore Parameters Menu		Next Label REP1
		Run Acquisition
		Continuous

Vertical Desc	Horizontal Desc	Acquire Desc	Graticules	Page to	Rem Wfm 1
L1	Main	Continuous		All Wfms Status	L1 Main
Fast	10MS/sec				
Input Parameters	FFT Control	Action Delta	Adjust Const1		Adjust Const2
DC	dBm	None	1		1
1MQ/300MHz	Rectang				

The Acquire Desc Pop-Up Menu

- Step 21: Touch Acquire Desc in the major menu and Average N in the pop-up menu to turn off averaging. Touch Continuous to restart acquisition.

This is an example of averaging. Enveloping is done similarly, using the Envelope N, Set EnvN, and Envelope Complete selectors.

Example 4: Using Signal Processing



Both averaging and enveloping can be done simultaneously. To do both, you must enter the waveform description from the DefWfm or Vertical Desc pop-up menus. No shortcut is available from the Acquire Desc pop-up menu.

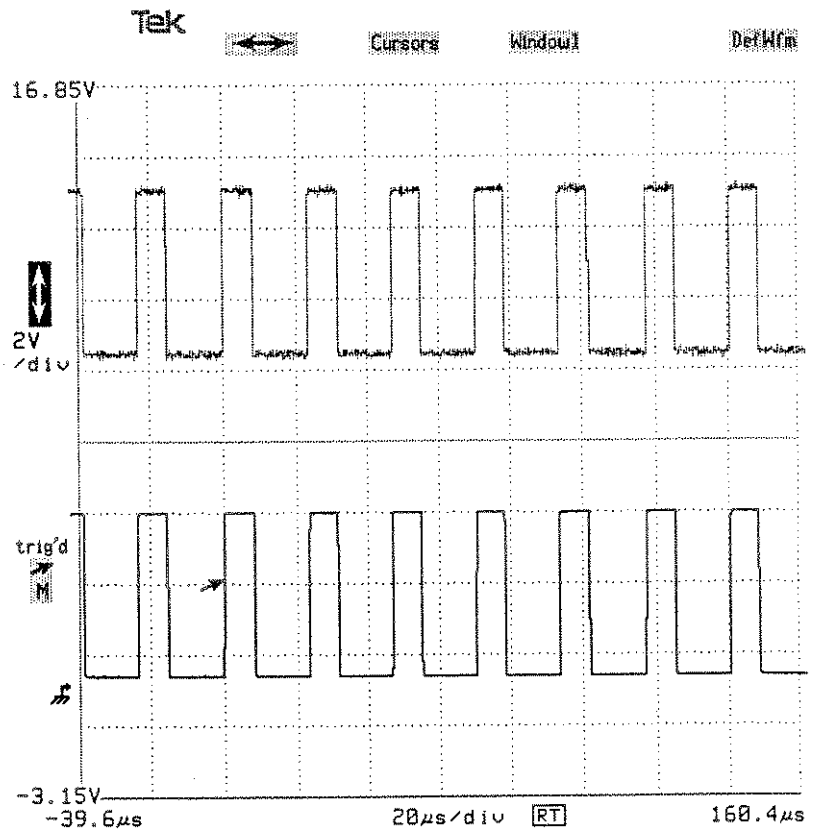

Normal and Averaged Waveforms

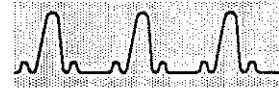

Record Length

You can specify the resolution of waveforms by setting the number of sample points in a waveform. This is important if you use a remote interface to transfer waveform data to a computer.

- Step 22: Touch **Horizontal Desc** in the Waveform major menu. In the **Horizontal Desc** pop-up menu, touch either **Main Record Length** or **Window Record Length** (both selectors assign the knobs identically).
- Step 23: Turn the left **Main Record Len** knob one click at a time to the left and right, and observe the difference in the main waveform.

The right knob similarly controls the window record length. You should be aware of the following attributes of record lengths:

- All Main time base waveforms share the same record length.
- All Window waveforms share the same record length.
- Initialization sets both record lengths to 1024 points.
- Infinite Persistence can only be used with record lengths of 512, 1024, or 2048 points.
- Some record lengths display shortened waveforms. For example, the 4096-point record length has the same resolution as a 5120-point record length, but appears shorter in length. Some computer systems can only handle record lengths from a remote interface that are an exact power of two. These record lengths are provided as a convenience, and visual truncation is a natural result.

Example 4: Using Signal Processing





Measurements



This section presents three examples that illustrate the power and flexibility of the DSA's automated measurement capabilities. The previous section, Getting Started, showed how to operate the DSA in a manner similar to a standard oscilloscope. This section extends your knowledge to automated measurement features that are unique to this DSA. The examples in this section will help you learn about:

- Taking automated measurements.
- Using and setting measurement annotations to control the measured portion of your waveform.
- Setting the measurement default parameters.

The automated measurement system can save you time and help you use the DSA efficiently.

Stored Waveforms

This section also presents two examples that demonstrate storing waveforms to disk and to RAM. The examples in this section will give you practice:

- Using the Utility 3 major menu.
- Comparing displayed and stored waveforms.
- Storing waveforms to RAM.
- Storing waveforms to disk.
- Using the **disk copy** feature.

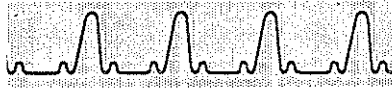

Example 5: Taking Automated Measurements	67
Specifying Measurements	68
Measurement Parameters and Annotations	72
Default Measurement Parameters	74
Example 6: Comparing Measurements to a Reference ..	77
Example 7: Taking Delay Measurements Using Cursors .	81
Options Control	82
Autoset Options	84
The Cursors Major Menu	84
Using Split Dot Cursors	88
Cursor Accuracy Considerations	91
Example 8: Comparing Displayed to Stored Waveforms .	93
Example 9: Using the Disk Drive to Store Waveforms ...	99
Disk Operations	100
Directory Operations	102
File Operations	104

Example 5: Taking Automated Measurements



NOTE
Never install or remove a plug-in unit while the DSA power is on.
Read the Operator Overview section for information about installing your DSA.

This example demonstrates how you can quickly display a dynamic measurement from a displayed waveform.

For this example you will need a DSA 601A or DSA 602A with a multichannel plug-in amplifier installed in the left compartment. You will also need the pocket signal generator.

The first step in taking a waveform measurement is to achieve a good display of that waveform.

- Step 1: Initialize the DSA: Press the **UTILITY** button in the **MENUS** column and touch **Initialize**. Touch **Initialize** in the pop-up menu.
- Step 2: Attach the large end of the pocket signal generator to the **CH 1** connector of the left plug-in amplifier. Attach the free end of the pocket signal generator to the **CH 2** connector of the left plug-in amplifier.

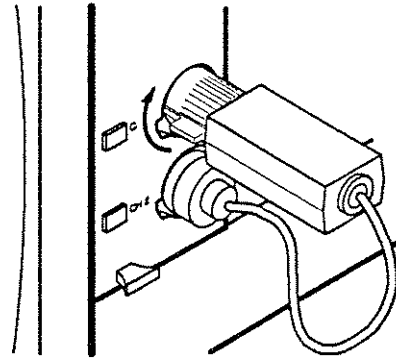

The Pocket Signal Generator Connected for Example 5

- Step 3: Press the **CH 1** button on the left plug-in amplifier.
- Step 4: Press the **AUTOSSET** button.

Example 5: Taking Automated Measurements

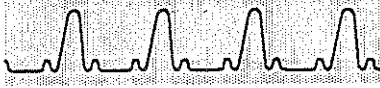

Get a stable waveform display before using the automated measurement system.

You should have a stable display of your signal showing several cycles. Make sure that all of the signal is on the display and that there are no places where the waveform extends above or below the graticule area. If any of the waveform is off of the graticule area, use the control knobs to move the waveform onto the display.

Specifying Measurements

The automated measurement system lets you specify a set of measurements for waveforms. The readouts of these measurements are continually updated to track changes in the signal. Many measurements are available, including rms voltage, peak-to-peak voltage, rise time, and frequency. You may specify up to six measurements to be taken simultaneously.

- Step 5: Press the **MEASURE** button in the **MENUS** column.

			Measure- ments	Page to Statistics Histogram

The Measure Major Menu

The Measure major menu is displayed. Initially, this menu appears mostly blank, because six of the selectors are reserved for your measurement readouts. The **Measurements** selector brings up a pop-up menu to let you choose the measurements you want.

- Step 6: Touch the **Measurements** selector.

Example 5: Taking Automated Measurements

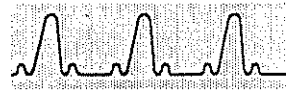

Measurements					
Amplitude	Area	Energy	Timing	Frequency	Freq Domain
Max	Mean		Rise	Fall	Spectral Freq
Mid	RMS		Freq- uency	Period	Spectral Mag
Min	Over Shoot		Delay	Prop- Delay	THD
Peak- Peak	Under Shoot		Cross	Width	
Gain	Energy		Duty Cycle	Phase	
Area +	Area -		Skew	Main+Win Trig Time	
Exit Menu			Clear All		

Peak- Peak 4.960 V	Freq- uency 41.34 kHz		Measure- ments	Page to	Rem Wfm 2
			Main Size 10μ s/div	Statistics Histogram	Main
				Pan/ Zoom Off	Main Position -21.2μ s

The Measurements Pop-Up Menu

Example 5: Taking Automated Measurements



The Amplitude Area Energy, Timing Frequency, and Freq Domain sections of this pop-up menu show the measurements that you can specify. The selectors in these areas turn each measurement on or off. When a measurement is turned on, its selector is highlighted in the menu. Also, one of the selectors in the Measure major menu displays the value of the measurement.

- Step 7: Touch the **Peak-Peak** and **Frequency** selectors.

The **Measurements** pop-up menu does not disappear as soon as you select a measurement, so that several measurements may be turned on at one time.

The readout areas of two of the selectors in the major menu area are no longer empty, but show the measured values you specified. The measurements are displayed and updated continuously.

You may want to view the waveform while watching the measured values.

- Step 8: Touch the **Exit Menu** selector at the bottom of the pop-up.

The measurement readouts apply to the selected waveform. When you select a different waveform, the same set of measurements will be displayed for it.

- Step 9: Press the **CH 2** button on the left plug-in amplifier. Observe that the same measurements are shown. Remove the new waveform by pressing the **CH 2** button a second time.

To remove a measured value from the major menu, simply reverse the process. First, open the **Measurements** pop-up menu by pressing **Measurements**. Touch the selector you would like removed. Then, close the menu. The measurement you deselected no longer appears on the display. For now, leave **Peak-Peak** and **Frequency** selected.

Example 5: Taking Automated Measurements

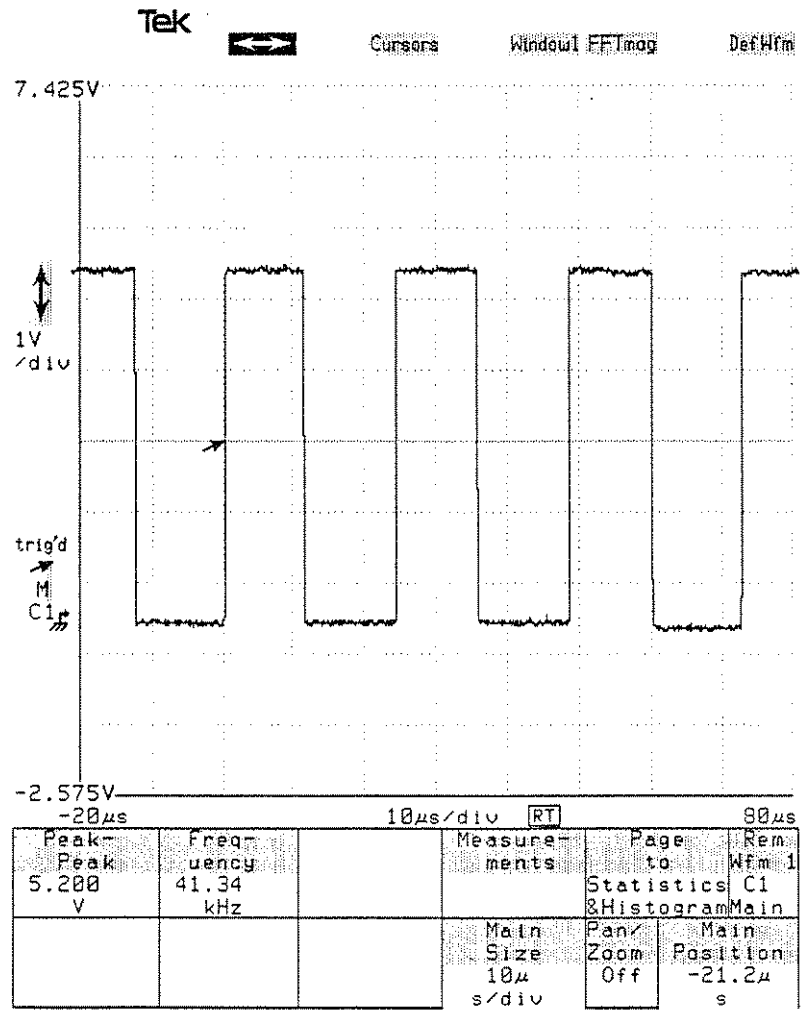
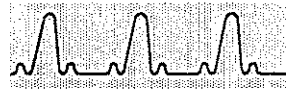

Measurements of a Waveform

Example 5: Taking Automated Measurements



Measurement Parameters and Annotations

For each measurement, additional information and more control is available. Touching the measurement selector in the major menu area does the following:

- Displays annotation lines on the graticule. These annotation lines graphically show the portions of the waveform that the measurement readout value is based on.
- Highlights the portion of the waveform that the measurement is based on. For example, the waveform shows several cycles of a signal, but the measurement system uses only one cycle to determine the frequency value. Only that one cycle is highlighted.
- Displays an individual measurement pop-up menu that documents the annotation lines and allows you to assign the knobs to control various measurement parameters.
- Step 10: Touch the **Frequency** selector in the major menu area. Touch the selector a second time to remove the pop-up menu.

Example 5: Taking Automated Measurements

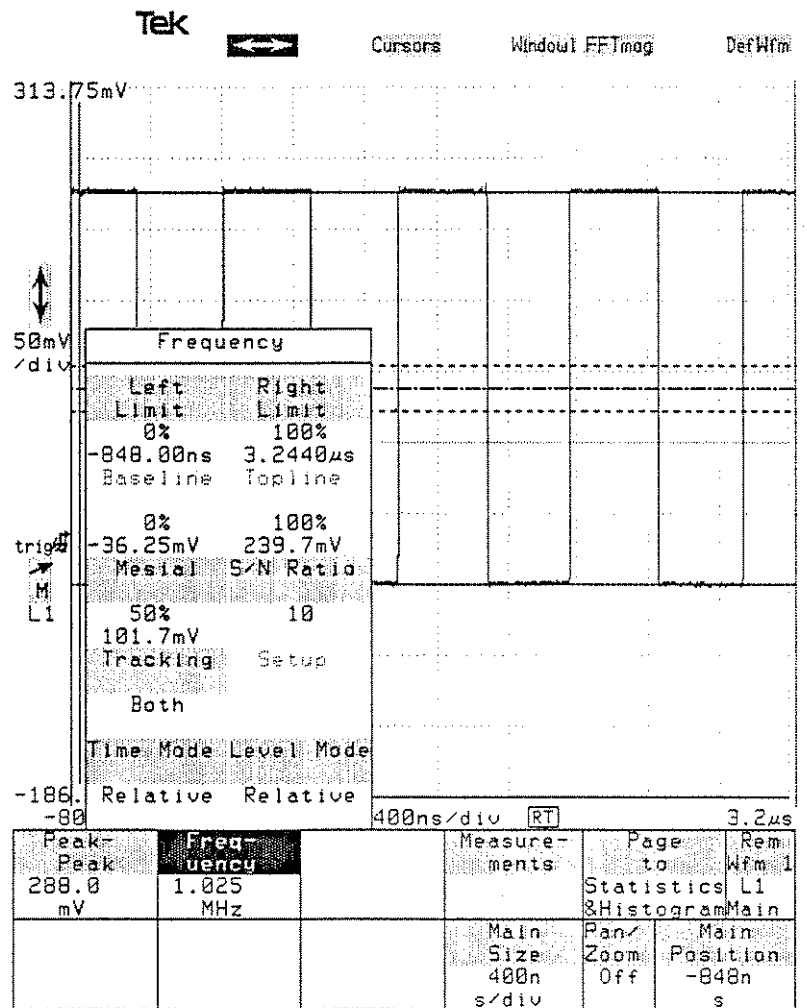
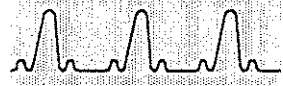

The Frequency Pop-Up Menu and Annotation Lines

Example 5: Taking Automated Measurements



When you change a measurement parameter, you change all measurements on the selected waveform. Other waveforms are not affected.

The annotation lines remain and you can see all of the display. Closely examine the **Frequency** pop-up menu.

- Step 11:** Touch the **Frequency** selector a third time to redisplay the menu. Touch either the **Left Limit** or **Right Limit** selector in the pop-up menu. Touching either selector assigns the knobs to the left limit and right limit measurement parameters.

The knob assignments remain after the pop-up menu is removed so that you can set the limits without a menu covering part of the display. If you want to remove the pop-up menu, touch the **Frequency** selector in the major menu area.

- Step 12:** Turn the left knob clockwise to set the left limit to 50%.

When you used the left limit bar to exclude the portion of the waveform where the measurement was being taken, the DSA took the measurement at the next opportunity on the waveform. This is shown by the highlighted portion of the waveform moving to the right.

- Step 13:** Touch the **Peak-Peak** selector in the major menu area. Observe that the left limit of this measurement is also 50%.

Default Measurement Parameters

Left and right limits are examples of measurement parameters, settings that you change to control the measurement system. Most parameters are shared by all the measurements being taken on any one waveform. This means that each waveform has an associated set of measurement parameters.

Each time a waveform is created, its measurement parameters are copied from the default parameter set. If you are taking measurements on several waveforms and want them all to have the same parameters, you can set the default parameters *before* creating any of the waveforms.

Example 5: Taking Automated Measurements



In addition, you can set the parameters for any waveform to the complete set of defaults at any time. Access the default parameters through the **Measurements** pop-up menu.

- Step 14:** Touch the **Page to Statistics&Histogram** selector on the major menu, and then touch the **Compare & Defaults** selector. Then touch **Default Parameters**.

The pop-up menu changes to show measurement defaults. No one measurement uses all of these parameters, but each parameter is used for one or more measurements.

Changing a default parameter does not affect any existing waveform or current measurement.

The various parameter selectors assign the knobs to one or two of the parameters. After setting the parameters as desired, all waveforms created in the future will initially have these measurement parameters.

- Step 15:** Touch the **Left Limit** or **Right Limit** selector, and use the knobs to set the default left limit of the measurement zone to 20% and the default right limit to 80%.

- Step 16:** Create a new waveform by pressing the **CH 2** button on the left plug-in amplifier.

The left and right limits of the measurement are now 20% and 80%.

- Step 17:** Touch the original waveform (the one showing channel L1) to select it.

The left and right limits of this waveform are unchanged from the original 50% and 100%.

In the **Default Parameters** version of the **Compare Default** pop-up menu, two additional selectors appear:

- **Initialize Defaults** resets the default parameter set to the settings that are in effect at initialization.

Example 5: Taking Automated Measurements

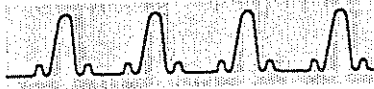

- **Copy Defaults to Sel Wfm** sets all the measurement parameters of the selected waveform to match the current default parameter settings.

Default Parameters				
	Initialize Defaults	Copy Defaults to Sel Wfm		
	LeftLimit	Time Mode	RightLimit	
	0%	Relative	100%	
	Tracking	Level Mode	Slope	
	Both	Relative	+	
Compare Options	Proximal	Distal	Reference Level	
	10%	90%	0	
Default Parameters	Mesial	S/N Ratio	Data Interval	
	50%	10	One Period	
Exit	Baseline	Topline		
	0	0		
Top=6.475V	Mean=0V	$\mu\pm 1\sigma=0\%$	Page	Rem
Btm=-1.525V	RMSΔ=0V	$\mu\pm 2\sigma=0\%$	to	Wfm: 1
Lft=-10μs	PKPk=0V	$\mu\pm 3\sigma=0\%$	Measure-	L1
Rgt=70μs	Hits=0	Wfms=0	ments Menu	Main
Histograms	Statistics	Compare & Defaults	Main Size	Pan/Zoom
Off	Off		10μ	Off
			s/div	Main Position
				-21.2μ
				s

The Default Parameters Pop-Up Menu

Example 6: Comparing Measurements to a Reference



NOTE
Never install or remove a plug-in unit while the DSA power is on.
Read the Operator Overview section for information about installing your DSA.

This example shows how to set up a reference measurement, and then compare other measurements to that reference.

For this example you will need a DSA 601A or DSA 602A with a multichannel plug-in amplifier installed in the left compartment. You will also need the pocket signal generator.

- Step 1: Initialize the DSA: Press the **UTILITY** button in the **MENUS** column and touch **Initialize**. Touch **Initialize** in the pop-up menu.
- Step 2: Attach the large end of the pocket signal generator to the **CH 1** connector of the left plug-in amplifier. Attach the free end of the pocket signal generator to the **CH 2** connector of the left plug-in amplifier.

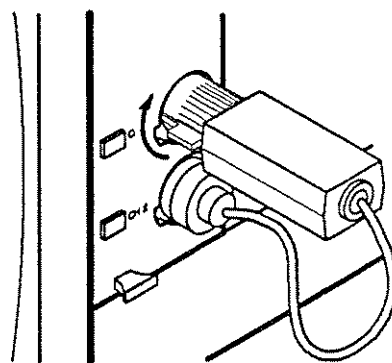

The Pocket Signal Generator Connected for Example 6

- Step 3: Press the **CH 1** button on the left plug-in amplifier.
- Step 4: Press the **AUTOSET** button.
- Step 5: Press the **CH 2** button on the left plug-in amplifier.

Example 6: Comparing Measurements to a Reference



- Step 6: Press the **MEASURE** button, and then touch the **Measurements** selector. Touch the **Peak-Peak** selector.

You will use this peak-to-peak measurement as a reference value, and display the peak-to-peak measurement of the other channel as a difference from this value.

A comparison value can be saved for each measurement. These values apply to all waveforms. You can set the comparison values as a copy of the current measurement values, or you can set the comparison values directly using the knobs.

- Step 7: Touch the **Page to Statistics&Histogram** selector in the Measure major menu.

- Step 8: Touch **Compare & Defaults**, then touch the **Save Current Meas Values as References** selector in the pop-up menu.

The current **Peak-Peak** measurement value is saved as the **Peak-Peak Ref** value. You change this value by touching the **Peak-Peak Ref** selector and using the knobs.

Example 6: Comparing Measurements to a Reference

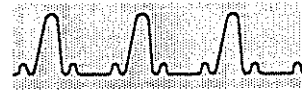

Compare and Reference Values				
	Compare On	Save Current Measurements as References		
	Adjust References			
Compare Options	Peak Peak Ref 5.12000 V			
Default Parameters				
Exit				
Top=6.475V	Mean=0V	$\mu\pm 1\sigma=0\%$	Page to Measurements	Rem Wfm 1
Btm=-1.525V	RMSΔ=0V	$\mu\pm 2\sigma=0\%$		
Lft=-10μs	PkPk=0V	$\mu\pm 3\sigma=0\%$		
Rgt=70μs	Hits=0	Wfms=0		
Histograms	Statistics	Compare & Defaults	Frequency Ref	Frequency Ref
Off	Off		0 Hz	0 Hz

The Compare & Reference Pop-Up Menu

- Step 9: Touch the **Compare** selector to set measurement comparison mode to On. Touch **Exit**, then the **MEASURE** button to return to the Measurements main menu.

The **Peak-Peak** measurement readout in the major menu area is changed to **ΔPeak-Peak**. The numeric readout shows the variance from the reference value.

- Step 10: Select the other displayed waveform by touching it.

The **ΔPeak-Peak** readout shows how much larger this peak-to-peak signal is than the reference peak-to-peak signal of the other waveform.

Example 6: Comparing Measurements to a Reference

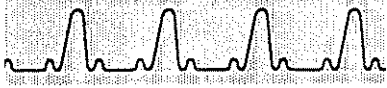

Example 7: Taking Delay Measurements Using Cursors

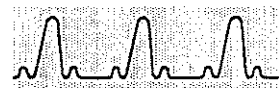

This example shows another way to measure waveform parameters using cursors. When the measurement you want to make is not included in the list of automated measurements, you can use cursors.

You will use the cursors to take two common measurements, pulse width and delay between waveforms. The DSA can do both of these as automated measurements, so you can compare the method of using automated measurements to using cursors.

For this example you will need a DSA 601A or DSA 602A with a multichannel plug-in amplifier installed in the left compartment. You will also need the pocket signal generator.

NOTE
Never install or remove a plug-in unit while the DSA power is on.
Read the Operator Overview section for information about installing your DSA.

- Step 1: Initialize the DSA: Press the **UTILITY** button in the **MENUS** column and touch **Initialize**. Touch **Initialize** in the pop-up menu.
- Step 2: Connect the large end of the pocket signal generator to the **CH 1** connector of the left plug-in amplifier. Attach the free end of the pocket signal generator to the **CH 2** connector of the left plug-in amplifier.

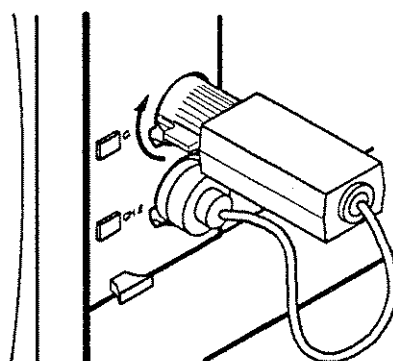

The Pocket Signal Generator Connected for Example 7

Example 7: Taking Delay Measurements Using Cursors

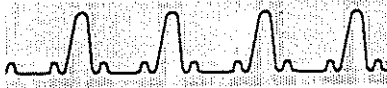

Options Control

This example will autoselect the noisy signal from the pocket signal generator, the one connected to channel 2 of the left plug-in amplifier. Autoset will not reliably trigger on this noisy signal. This is a TTL signal, and you can tell the DSA to use that fact to set the vertical acquisition parameters during autoset.

- Step 3: Press the **UTILITY** button and touch the **Modes** selector.

This pop-up menu has controls for several other DSA parameters.

- **Enhanced Accuracy Mode** set to Automatic will cause the DSA to perform an Enhanced Accuracy calibration whenever the internal temperature of the DSA changes.
- **Vectored Waveforms** controls the appearance of waveforms. The *DSA 601A and DSA 602A User Reference* has a complete discussion of this topic.
- **Waveform Scaling** lets you force all new waveforms to be calculated waveforms. This is discussed in Example 3.
- **Audio Feedback** turns on and off the touch screen beep.
- **Multitrace Pan/Zoom** allows concurrent panning and zooming of multiple traces.
- **Pan/Zoom Pivot** is the point from which the waveform is expanded.
- **Averaging Type** is your choice of either summation or back weighted averaging.
- **Zoom Intp** provides a choice of zoom interpolation algorithms.

Example 7: Taking Delay Measurements Using Cursors



Instrument Modes					
Autoset					
Vertical	Horizontal	Undo Last			
Pk-Pk	Period	AutoSet			
Miscellaneous					
Multitrace	Pan/Zoom	Averaging	Enhanced		
Pan/Zoom	Pivot	Type	Accuracy		
Off	Center	Backweight	Manual		
Vectorized	Zoom	Stored	Wfm	Incremental	
Waveforms	Intrp	Time Fmt	Acquire		
On	Sin(x)/x	Show	Disabled		
	Prefilter	Date			
Waveform	Audio	Default	Cursor		
Scaling	Feedback	Cursor	Hold		
Optional	On	Paired	Off		
		Dots			
Trigger					
DC Level					
Screen					
Calibrator	Modes	Probes	Color	Page to	Rem
				Utility 2	Wfm 1
					L1
					Main
Initialize	Time 2	Label	Main	Pan/	Main
	Date		Size	Zoom	Position
	14:50:15	Disp: On	50μ	Off	-6μ
	10-OCT-90	Mode: Man	s/div		s

The Modes Pop-Up Menu

- **Stored Waveform Time Format** lets you choose to show either date or hundredths of a second under a stored waveform selector.
- **Cursor Hold**, when ON, lets the cursors remain on the screen when you change between major menus. Does not apply to the Measure Menu.

Example 7: Taking Delay Measurements Using Cursors



- **Trigger DC Level** when the Trigger DC Level is **absolute** the trigger maintains the selected trigger level regardless of the vertical offset. When the Trigger DC Level is **screen** the trigger position is fixed relative to the screen.

Autoset Options

In the **Modes** pop-up menu of the Utility 1 major menu, the Autoset controls let you specify vertical and horizontal autoset separately.

Undo Last Autoset helps recover from unexpected results or from accidental selection of the Autoset function.

- Step 4: Touch the **Vertical** selector until **TTL** is displayed.
- Step 5: Press the **CH 2** (not **CH 1**) button on the left plug-in amplifier.
- Step 6: Press the **AUTOSET** button.

The Cursors Major Menu

You will use the cursors to determine the pulse width of the signal. The following steps introduce the use of cursors on a single waveform. You will then use cursors to measure the delay between two different waveforms.

The recommended way of using cursors is to display the waveform(s) first, then invoke the cursors to take the measurement.

- Step 7: Touch the **Cursors** icon located above the graticule.

This icon, like most icons, assigns the knobs, in this case to control the cursor positions. However, the **Cursors** icon is unique in that it behaves much like a major menu button. It replaces the major menu with the special **Cursors** major menu and highlights the **Cursors** icon instead of lighting any major menu button label.

Always display the waveforms *before* invoking the cursors.

Example 7: Taking Delay Measurements Using Cursors

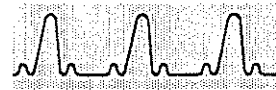

The Cursors major menu has two selectors, the **Cursor Type**, and a **Page to Previous Menu** selector. The remainder of the major menu area displays the cursor positions and distance between cursors. You can select four types of cursors:

- **Vertical Bars**, which you move with the knobs to the desired horizontal position. The major menu shows the positions of the cursors and the distance between them in X-axis units. Also, if the X-axis units are seconds, the inverse of the distance between the cursors is shown. This usually represents frequency.
- **Horizontal Bars**, which you move with the knobs to the desired vertical position. The major menu shows the positions of the cursors and the distance between them in Y-axis units.
- **Paired Dots**, which you move to the desired horizontal position using the knobs. The dots "float" vertically on the waveform; you cannot control the vertical position. The major menu shows both vertical and horizontal positions of the cursors, in graticule units. Also, if the X-axis units are seconds, the inverse of the distance between the cursors is shown. Also shown is the vertical distance of the cursors divided by the horizontal distance.
- **Split Dots**, which operate like paired dots, but on two different waveforms of your choice. The same data is shown as for paired dots.

Example 7: Taking Delay Measurements Using Cursors

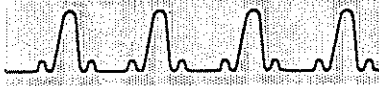

Cursor Type		Move Cursor 2 to	
Vertical Bars	Paired Dots	Wfm 1	Wfm 2
		L1	L2
		Main	Main
Horizontal Bars		Split Dots	
		Coarse Dots Mode Fixed Interval	
$t1 = -10.00\mu s$ $t2 = 70.00\mu s$ $\Delta t = 80.00\mu s$ $1/\Delta t = 12.50kHz$		Cursor Type	Page to Previous Menu
		Vertical Bars	Cursor 2
		Cursor 1	Cursor 2
		-10.00 μs	70.00 μs

The Cursors Major Menu and Cursor Type Pop-Up Menu

The vertical bar cursors are used to take timing measurements. You move them left and right with the knobs to the position you desire.

- Step 8: Touch the **Cursor Type** selector in the Cursors major menu, and touch the **Vertical Bars** selector.

To precisely position the cursors, set the knobs to fine resolution.

- Step 9: Use the left knob to move the left cursor to the first rising edge of the waveform. Use the right knob to move the right cursor to the first falling edge of the waveform that occurs after the first rising edge.

Example 7: Taking Delay Measurements Using Cursors

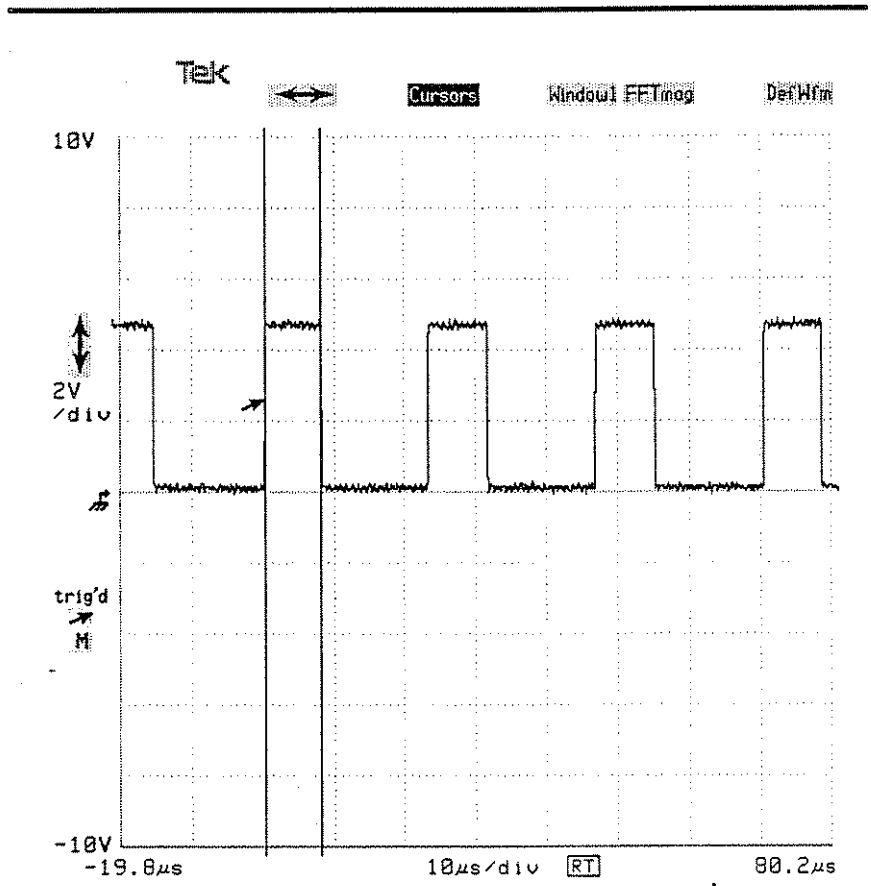
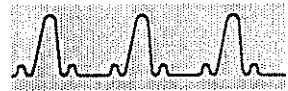

Vertical Bar Cursors Placed On a Waveform

Example 7: Taking Delay Measurements Using Cursors



The major menu area shows the time values of each cursor, and Δt shows the time between the cursors.

The same value can be determined by using the automated measurement system's width measurement.

Each waveform can have its own cursor type. The default cursor type for new waveforms is paired dots.

Using Split Dot Cursors

Dot cursors are small dots that "float" on the waveform. You position them horizontally using the knobs, but their vertical height is determined by the waveform on which they are placed.

Split dot cursors are placed on two different waveforms of your choice. Follow the convention of displaying the waveforms before invoking the cursors.

- Step 10: Press the **CH 1** button on the left plug-in amplifier.
- Step 11: Touch the **Cursor Type** selector in the Cursors major menu, and then the **Split Dots** selector in the pop-up menu.

The pop-up menu is not immediately removed, so that you can select the waveform for the second cursor dot. Until you select the second waveform, both dots are on the selected waveform and operate as paired dots.

To the right of the cursor type selectors, a second set of selectors lists all of the waveforms on the display. The highlighted selector always indicates the waveform with the second cursor.

Each waveform selector for the second cursor shows the waveform description.

Example 7: Taking Delay Measurements Using Cursors



- Step 12: Touch the Wfm1 selector in the Cursor Type pop-up menu.

One dot is now placed on each of the two displayed waveforms.

Cursor Type		Move Cursor 2 to	
Vertical Bars	Paired Dots	Wfm 1	Wfm 2
		L1	L2
		Main	Main
Horizontal Bars	Split Dots		
	Coarse Dots Mode		
	Fixed Interval		
v1 = 40.00mV	t1 = -21.20µs	Cursor Type	Page to Previous Menu
v2 = 4.880V	t2 = 81.10µs	Split Dots	Rem: Wfm: 2
Δv = 4.840V	Δt = 102.3µs	Cursor 1	L2 Main
	1/Δt = 9.775kHz	-21.20µs	Cursor 2
	Δv/Δt = 47.31V/ms		81.10µs

The Cursor Type Pop-Up Menu in Split Dots Mode

The major menu area shows the vertical and horizontal positions of both cursors. It also shows the distance between the cursors in both axes. The Δt readout shows the delay between the cursor positions. The $\Delta v/\Delta t$ readout is the slope and is used to measure the slew rate.

- Step 13: Turn the left knob clockwise to move the left cursor to the first rising edge of the waveform it is on. Change the knob resolution to FINE to position the cursor precisely.
- Step 14: Turn the right knob counterclockwise to move the right cursor to the first rising edge of the other waveform.

Example 7: Taking Delay Measurements Using Cursors

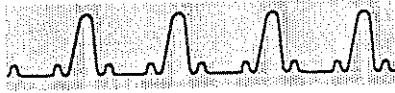

The Δt readout in the major menu area now shows the delay between the two waveforms.

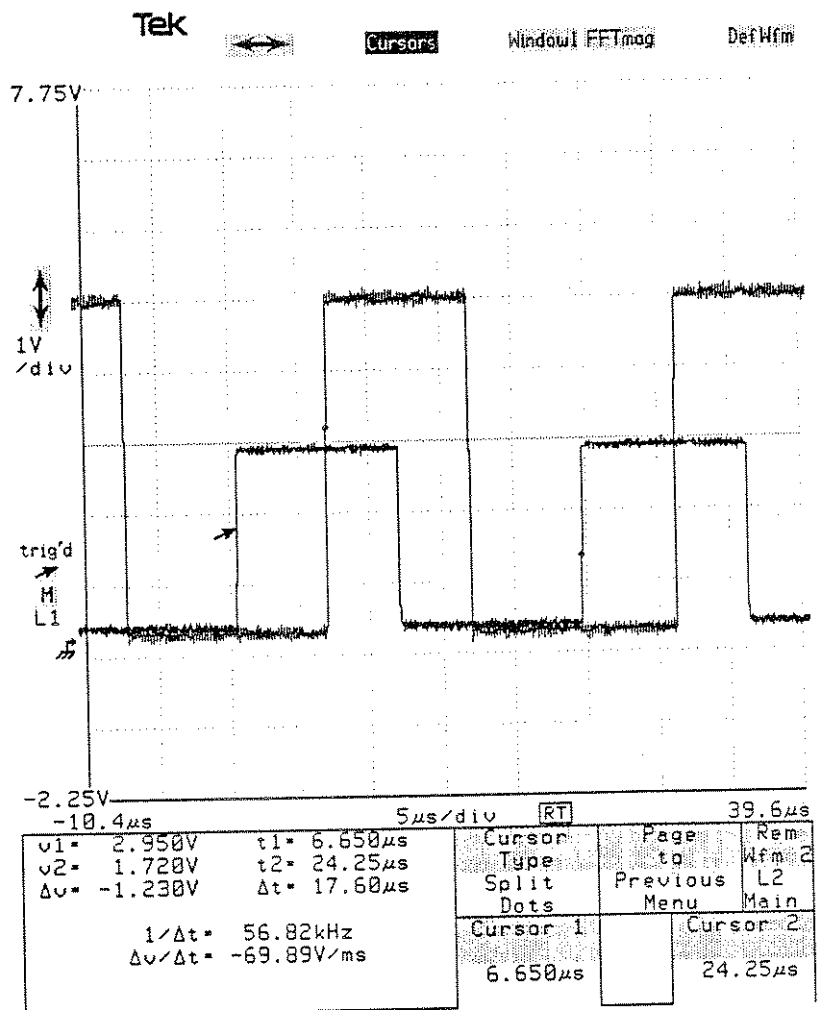

Using Split Dot Cursors to Measure Delay

Example 7: Taking Delay Measurements Using Cursors

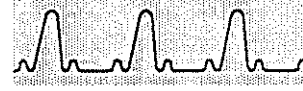

Cursor Accuracy Considerations

Cursor measurements are limited to the resolution of the display. Tips to help you get the most accuracy from measurements are:

- Use the automated measurement system whenever you can, both for convenience and for accuracy.
- Use dot cursors instead of bar cursors to take a more precise measurement. Dot cursors are positioned with waveform resolution (the dot cursor resolution is equal to the waveform sample interval) while bar cursors are positioned with display resolution (the bar cursor resolution is the distance between display pixels).
- Always use the fine knob resolution to perform the final cursor positioning.
- When using dot cursors, use the longest record length that you can. This will provide the greatest number of waveform points for the cursors to track, resulting in greater accuracy.
- Always make the area to be measured as large as possible, and cover as much of the graticule area as you can. This will give the finest resolution.

Example 7: Taking Delay Measurements Using Cursors

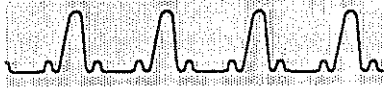

Example 8: Comparing Displayed to Stored Waveforms



This example demonstrates how to store a waveform that is a “snapshot” of a particular moment, and how to use the stored waveform as a basis for comparing other waveforms. This is similar to Example 6, where you used a reference measurement as a basis for comparison. Here, an entire waveform becomes the basis for comparison.

NOTE

Never install or remove a plug-in unit while the DSA power is on.

Read the Operator Overview section for information about installing your DSA.

For this example you will need a DSA 601A or DSA 602A with a multichannel plug-in amplifier installed in the left compartment. You will also need the pocket signal generator.

- Step 1: Initialize the DSA: Press the **UTILITY** button in the **MENUS** column and touch **Initialize**. Touch **Initialize** in the pop-up menu.
- Step 2: Attach the large end of the pocket signal generator to the **CH 1** connector of the left plug-in amplifier. Attach the free end of the pocket signal generator to the **CH 2** connector of the left plug-in amplifier.

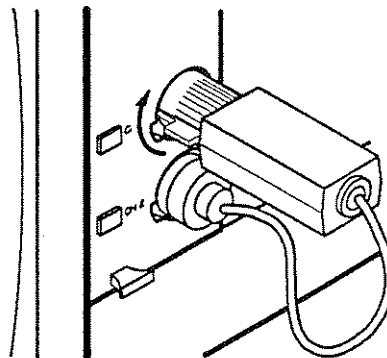

The Pocket Signal Generator Connected for Example 8

- Step 3: Press the **CH 1** button on the left plug-in amplifier.

Example 8: Comparing Displayed to Stored Waveforms

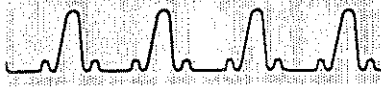

- Step 4: Press the **AUTOSET** button.

You will store this waveform, and then define a new waveform that shows the difference between a signal and the stored waveform. *Storing a waveform* means storing a copy of each data point that forms the waveform on the display.

The **STORE/RECALL** button allows you to store and recall waveforms and front panel settings to either RAM or to the disk drive. (This example describes how to save to RAM; Example 9 describes the disk drive operations.) In addition, you can clear waveforms (discard accumulated data and force reacquisition) and delete waveforms.

- Step 5: Press the **STORE/RECALL** button, then touch the **Store Waveform** selector.
- Step 6: At the top of the pop-up menu are selectors for **RAM** and **DISK**. Touch **RAM**.

Observe the number below the **Set Next STO Index** selector on the pop-up menu. This is the permanent number of the waveform you will store.

- Step 7: Touch **Set Next STO Index**. The control knobs are now set to change the storage number. Turn either knob until 15 is displayed. Touch the **Wfm 1** selector.

Example 8: Comparing Displayed to Stored Waveforms

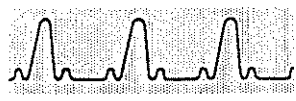

Store Waveform To					
RAM DISK					
Wfm 1					
C1					
Main					
Store All		Set Next			
STO Index		STO1			
Free Stored Wfm RAM					
470016 bytes					
Store	Recall	Delete	Disk	Page	Rem
Waveform	Waveform	Waveform	Copy	to	Wfm 1
				Stored	C1
				Wfm Scan	Main
Store	Recall	Delete	Set Next		Set Next
Setting	Setting	Setting	STO Index		STO Index
			1		1

The Store Waveform Pop-Up Menu

Example 8: Comparing Displayed to Stored Waveforms

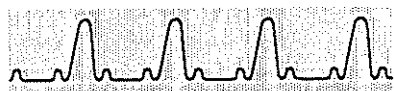

The DSA has stored the waveform in memory location number 15. Once the waveform is stored, there is no reason to leave its source on the display.

- Step 8: Remove the displayed waveform by touching the **Rem Wfm 1** selector and verifying removal in the pop-up menu.

You can display the stored waveform. When displayed, it will not appear "live" because it is displaying a fixed set of data points.

- Step 9: Touch the **DefWfm** icon, followed by **Stored Waveforms, STO 15** (15 is the number that you entered for **Set Next STO Index**), and **Enter Desc**.

You will compare this stored waveform to the signal coming from channel 2 of the left plug-in amplifier.

- Step 10: Touch the **DefWfm** icon, followed by **L2** and **Enter Desc**.
- Step 11: Touch the vertical icon (\updownarrow) and use the right knob to position the L2 waveform at the same height as the stored waveform. Use the horizontal icon (\leftrightarrow) to similarly position the L2 waveform horizontally. Try to overlay the two waveforms as closely as possible.

- Step 12: Touch the stored waveform to select it, and then remove it by touching the **Rem Wfm 1** selector and verifying removal in the pop-up menu.

You can use the **Vertical Desc** pop-up menu to modify the vertical description of the displayed waveform. You will modify it to show the difference between channel L2 and the stored waveform.

- Step 13: Touch the **Vertical Desc** selector, and touch **- (minus), Stored Waveforms, STO 15**, and **Enter Desc**.

Example 8: Comparing Displayed to Stored Waveforms



The method just demonstrated is useful in cases where you are tuning a circuit to a standard of performance. First you save the desired waveform from a circuit of known characteristics, then use the difference waveform to observe other circuit samples. These circuits can then be dynamically tuned to the same performance.

To more accurately quantify the signal variation, you can use the **RMS** measurement.

Example 8: Comparing Displayed to Stored Waveforms



Example 9: Using the Disk Drive to Store Waveforms

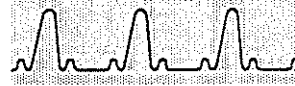

This example is similar to Example 8, where you stored a waveform to RAM, and then used the stored waveform as a basis for comparing other waveforms. Here, you will learn how to use the disk drive to store waveforms and settings, and work with the files you have stored.

NOTE

Never install or remove a plug-in unit while the DSA power is on.

Read the Operator Overview section for information about installing your DSA.

For this example you will need a DSA 601A or DSA 602A with a multichannel plug-in amplifier installed in the left compartment. You will also need the pocket signal generator.

- Step 1: Initialize the DSA: Press the **UTILITY** button in the **MENUS** column and touch **Initialize**. Touch **Initialize** in the pop-up menu.
- Step 2: Attach the large end of the pocket signal generator to the **CH 1** connector of the left plug-in amplifier. Attach the free end of the pocket signal generator to the **CH 2** connector of the left plug-in amplifier.

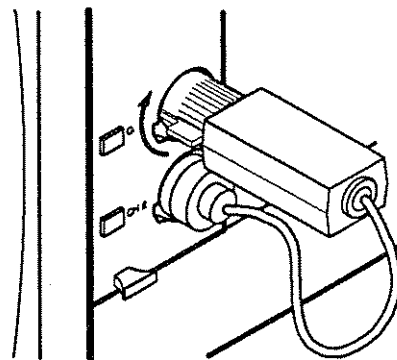

The Pocket Signal Generator Connected for Example 9

- Step 3: Press the **CH 1** button on the left plug-in amplifier.
- Step 4: Press the **AUTOSET** button.

Example 9: Using the Disk Drive to Store Waveforms



Storing a waveform to the floppy disk involves working with the Utility 3 and Store/Recall major menus. The Utility 3 major menu contains commands for controlling the disk drive. As you learned in Example 8, the **STORE/RECALL** button allows you to store and recall waveforms and front panel settings. In addition, you can clear waveforms and delete waveforms.

- Step 5: Touch the **UTILITY** button until the Utility 3 major menu is displayed. (You can also enter the Utility 3 major menu by touching the **Page to** selector until the third menu appears.)

Disk Ops	Directory Ops	File Ops		Page to Utility 1	Rem Wfm 3 C1 Wind.
			Window Size 1μ s/div	Pan/Zoom Off	Window Position -7.5μ s

The Utility 3 Major Menu

The Utility 3 major menu contains three selectors: **Disk Ops** (Operations), **Directory Ops** (Operations), and **File Ops** (Operations). Each of these selectors provides a pop-up menu. At the top of each pop-up menu is a command line that displays the MS-DOS command for each operation. Also in each pop-up menu are DSA selectors that can be used as shortcuts for entering MS-DOS commands. (A complete discussion of each selector is provided in the *DSA 601A and DSA 602A User Reference*.)

Disk Operations

The **Disk Ops** pop-up menu allows you to format, label, and check disks. The **format** selector in the pop-up menu prepares a floppy disk for use. The disk can be either new or previously formatted; however, formatting erases any existing files, so be careful not to format a disk that contains files you need.

Example 9: Using the Disk Drive to Store Waveforms

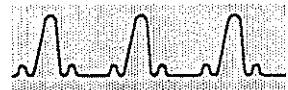

Disk Operations									
A: \>									
File Type	format	label	chkdisk	A:	Enter				
File Data Format									D: RAM
1	2	3	4	5	6	7	8	9	0
Q	W	E	R	T	Y	U	I	O	P
A	S	D	F	G	H	J	K	L	?
Z	X	C	V	B	N	M	_	\$	% Space
Keyboard File List			Erase BackSpace		Exit				
Disk Ops	Directory Ops	File Ops		Page to Utility 1	Rem Wfm 1 L1 Main				
			Main Size 10μ s/div	Pan/Zoom Off	Main Position -21.2μ s				

The Disk Ops Pop-Up Menu

- Step 6: Insert a 3.5 inch disk into the disk drive. Touch the **Disk Ops** selector. Touch the **format** selector in the Disk Operations pop-up menu, then **A:** and **Enter**. The light on the

Example 9: Using the Disk Drive to Store Waveforms

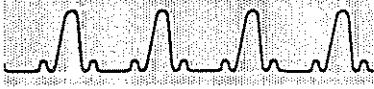

disk drive illuminates to indicate that the disk is being formatted. The dialog area displays status information as the disk is formatted.

Directory Operations

The **Directory Ops** pop-up menu allows you to make, change, remove, and rename directories, or list the existing directories. (See the *DSA 601A and DSA 602A User Reference* for more information about working with directories.) For now you will create two directories.

- Step 7: When the formatting is complete, touch the **Directory Ops** selector. Touch **mkdir, A:**, and **Keyboard**, then type in **T, E, S, T, 1**, and **Enter** to create a directory.

You have now created a directory called TEST1 on drive A: of the newly formatted disk. To verify that you have created the directory:

- Step 8: Touch **dir, A:**, then **Enter**. The TEST1 directory should be displayed in the file list.
- Step 9: To make the second directory, touch **mkdir, A:**, then **Keyboard**. Type in **T, E, S, T, 2**, and **Enter**. Touch **dir, A:**, then **Enter** to verify that you created directory TEST2. Touch **Exit** to return to the Utility 3 major menu.

Example 9: Using the Disk Drive to Store Waveforms

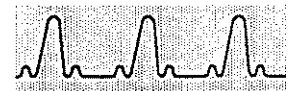

Directory Operations										
A:\>										
File Type	chdir			mkdir			rmdir			A: Enter
File Data Format	rmdir			dir			D: RAM			
1	2	3	4	5	6	7	8	9	0	.
Q	W	E	R	T	Y	U	I	O	P	>
A	S	D	F	G	H	J	K	L	'	*
Z	X	C	V	B	N	M	_	\$	%	Space
Keyboard		File List			Erase		BackSpace		Exit	
Disk Ops	Directory Ops			File Ops			Page to Utility 1		Rem. Wfm 1 L1 Main	
						Main Size 10μ s/div	Pan/Zoom Off	Main Position -21.2μ s		

The Directory Ops Pop-Up Menu

Example 9: Using the Disk Drive to Store Waveforms

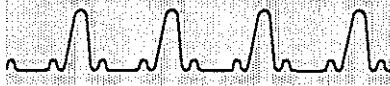

File Operations

The File Ops pop-up menu allows you to specify the file type and data format, and to rename, copy, and delete files. You can also set the file attributes and specify custom file prefixes.

File Operations										
A:\>										
File Type	attrib		rename		copy		A:		Enter	
waveform										
File Data Format	delete		prefix				D:			
binary			STO				RAM			
.WFB										
1	2	3	4	5	6	7	8	9	0	.
Q	W	E	R	T	Y	U	I	O	P	*
R	S	D	F	G	H	J	K	L	?	+
Z	X	C	V	B	N	M	_	\$	%	Space
Keyboard		File List		Erase		BackSpace		Exit		
Disk Ops	Directory Ops		File Ops				Page to Utility 1		Rem Wfm 1 L1 Main	
					Main Size 10μ s/div		Pan/Zoom Off		Main Position -21.2μ s	

The File Ops Pop-Up Menu

Example 9: Using the Disk Drive to Store Waveforms

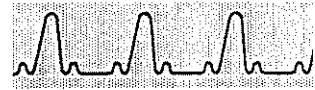

- Step 10: Touch **File Ops**, then touch **File Type** in the file operations pop-up menu until **waveform** appears. Touch **File Data Format** until **binary .WFB** appears.

- Step 11: Touch **Exit** to return to the main menu.

You are now ready to store waveforms to the disk.

- Step 12: Press the **STORE/RECALL** button, then touch the **Store Waveform** selector.

As described in Example 8, the same Store Waveform pop-up menu appears for both DISK and RAM storage.

- Step 13: At the top of the pop-up menu are selectors for **RAM** and **DISK**. Touch **DISK**.

Observe the filename below the **Set Next STO Index** selector on the pop-up menu. This is the filename that will be assigned to this stored waveform. As with storage to RAM, the **STO Index** number can be changed by using the control knobs.

- Step 14: Touch **Set Next STO Index**. The control knobs are now set to change the storage number. Turn either knob and observe how the numbers change. Turn either knob until **STO1.WFB** is displayed. Touch the **Wfm 1** selector.

The light on the disk drive illuminates to indicate that the file is being sent to the disk. After the file has been sent, the pop-up menu disappears.

- Step 15: Remove the displayed waveform by touching the **Rem Wfm 1** selector and verifying removal in the pop-up menu by touching **Remove Wfm 1**.

You can recall and display the stored waveform. When displayed, the waveform will not appear "live" because the DSA is displaying a fixed set of data points.

Example 9: Using the Disk Drive to Store Waveforms

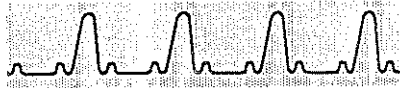

- Step 16: Recall your stored waveform by using **Recall Waveform** in the **STORE/RECALL** major menu. Touch **Recall Waveform**, **DISK**, and touch **STO1.WFB**.

Alternatively, you can recall your stored waveform by touching the **Def Wfm** icon, followed by **Stored Waveforms**, **DISK**, then **STO1.WFB** and **Enter Desc**.

You will compare this stored waveform to the signal coming from channel 2 of the left plug-in amplifier.

- Step 17: Touch the **DefWfm** icon, followed by **L2** and **Enter Desc**.
- Step 18: Touch the vertical icon (\updownarrow) and use the right knob to position the **L2** waveform at the same height as the stored waveform. Use the horizontal icon (\leftrightarrow) to similarly position the **L2** waveform horizontally. Try to overlay the two waveforms as closely as possible.
- Step 19: Touch the stored waveform to select it, and then remove it by touching the **Rem Wfm 1** selector and verifying removal in the pop-up menu.

You can use the **Vertical Desc** pop-up menu to modify the vertical description of the displayed waveform. You will modify it to show the waveform of the difference between channel **L2** and the stored waveform.

- Step 20: Touch the **Vertical Desc** selector, **-** (minus), and **Stored Waveforms**. Select **STO1.WFB** (the waveform you would like to recall), and touch **Enter Desc**.

The method just demonstrated is useful in cases where you are tuning a circuit to a standard of performance. First you save the desired waveform from a circuit of known characteristics, then use the difference waveform to observe other circuit samples. These circuits can then be dynamically tuned to the same performance.

Example 9: Using the Disk Drive to Store Waveforms

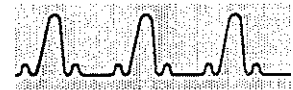

Vertical Description					
L1	C1	R	7	8	9 +
L2	C2		4	5	6 -
L3	C3		1	2	3 *
L4	C4		0		EEF ✓
Waveform		ST01.WFB			
Functions		14:21:46 24-OCT-90			
Stored Waveforms		RAM DISK			
Adjustable Constants					
Enter Desc		()		Back Space Cancel	
Vertical Desc	Horizontal Desc	Acquire Desc	Graticules	Page to All Wfms Status	Rem Wfm
Input Parameters	FFT Control dBm Rectang	Act on Delta None	Main Size 10μ s/div		Main Position -21.2μ s

The Vertical Desc Pop-Up Menu

Example 9: Using the Disk Drive to Store Waveforms



Now that you have stored a waveform to the floppy disk, you can use the **File Ops** selector to rename, copy, or delete files. You can use **copy** to copy a file within a directory, or from one directory to another. (Whenever you copy a file, it is a good idea to give the copy a new filename.)

- Step 21:** Page to Utility 3. Touch **File Ops** then touch **File List**. Touch **copy**, then **A:**, then select **STO1.WFB** (the file you want to copy). To copy this file under a new name to the **TEST1** directory, touch **Space, A:**, keyboard, ****, and select the directory **TEST1**. To enter a new name, touch **Keyboard, **, then type in **F,I,L,E,1, .,W,F,B**, (the new filename). Remember, file and directory names must be eight characters or less. The entry line will appear as: **copy A:STO1.WFB A:\TEST1\FILE1.WFB**. Finally, touch **Enter**.
- Step 22:** To verify the change, touch **Directory Ops** in the main menu. Touch **File List**, dir, **A:**, and select the **TEST1** directory. The file you copied and renamed **FILE1.WFB** is displayed in the File List.

You can rename a file using the **rename** selector.

- Step 23:** Touch **File Ops**.
- Step 24:** Touch the **rename** selector in the **File Ops** pop-up menu. Then touch **A:**, **File List**, then select **STO1.WFB** (the file you want to rename). Touch **Space, A:** then **Keyboard**. Type in **W,F,M,1, .,W,F,B** (the new filename). The entry line will appear as: **rename A:STO1.WFB A:WFM1.WFB**. Finally, touch **Enter**.
- Step 25:** To verify the change, touch **File List** in the pop-up menu. The file, **WFM1.WFB**, is displayed in the file list.

When renaming files, use the same extension as the original file. The extension indicates the type of file, and enables the DSA to manipulate the file accordingly. For example, the extension **WFB** indicates that the file is a waveform file with binary data. The type

Example 9: Using the Disk Drive to Store Waveforms

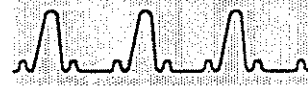

of data must match the extension name or an error will be generated when you attempt to recall the waveform.

Deleting a file is a very simple procedure. You will once again be working in the **File Ops** pop-up menu.

- Step 26:** To delete a file, press the **Utility 3** button until the **Utility 3** main menu is displayed. Touch **File Ops**, the **delete selector, A:**, **File List, WFM1.WFB** (the file you want to delete), then **Enter**. "File not found" will be displayed in the **File List** area. The deleted file path is shown directly above the **File List** area.
- Step 27:** To delete a file in a directory, touch the **delete selector, A:**, the **TEST1** directory, **FILE1.WFB** (the file you want to delete), then **Enter**. To verify the change, touch **Directory Ops, dir, A:**, then select the directory **TEST 1** again. The file will no longer appear in the directory.
- Step 28:** To delete a directory, touch **rmdir, A:**, **keyboard, **, select **TEST2**, then press **Enter**. The directory will disappear from the **File List** of directories. If there are files in the directory, remove them using the **delete selector** in the **File Ops** pop-up menu.

Only empty directories can be deleted.

The rest of this example demonstrates how to copy data stored in RAM to disk. A repetitive trigger acquisition will store ten waveforms to RAM. The ten waveforms will be copied from RAM to disk using the disk copy feature in the **STORE/RECALL** menu.

- Step 29:** Initialize the DSA: Press the **UTILITY** button in the **MENUS** column and touch **Initialize Setting** in the pop-up menu.
- Step 30:** Press **CH 1**, on the left plug-in amplifier.
- Step 31:** Press the **AUTOSET** button. A stable waveform should be displayed.

Example 9: Using the Disk Drive to Store Waveforms



- Step 32: Press the **UTILITY** button and page to the Utility 3 Major Menu.
- Step 33: Change directories to **A:\TEST1:**. Touch **Directory Ops**, then touch **chdir**. Touch **Directory List**. A list of the available directories appears. Touch **A:** then **TEST1**. Touch **Enter** then **Exit**.
- Step 34: Prepare the digitizer to perform a repetitive trigger acquisition. Press the **WAVEFORM** button in the menus column.
- Step 35: Touch **Acquire Desc**. Set the # of acquisitions to 10. Touch **Set Rep Trigger N** and turn either knob until the number 10 appears. You may need to use the fine control.
- Step 36: Touch **Rep Trig Complete**. Notice that the live waveform vanished. Touch the **Acquire Desc** selector to exit from the pop-up.
- Step 37: Acquire the 10 waveforms by pressing the **DIGITIZER** button.

Now you will verify that the waveforms have been acquired and stored in RAM.

- Step 38: Press the **STORE/RECALL** button in the **MENUS** column.
- Step 39: Touch the **Disk Copy** selector, then touch the **RAM** icon. At least 10 stored waveform filenames should appear. Select all the newly stored waveforms by touching **STO REP1:1**. Notice that all stored repetitive trigger acquisition light up.
- Step 40: Touch **Copy Selected Waveforms** to copy all the selected waveforms to the current directory on the disk. Notice that as the waveforms are copied they are listed in the status area as **STO1.WFB**, **STO2.WFB**, etc.

Example 9: Using the Disk Drive to Store Waveforms



- Step 41: To verify that the waveforms are on the disk, touch the **UTILITY** button until the Utility 3 Major Menu appears. Touch **Director Ops**, make sure you are in the **TEST1** directory, then touch **File List**. Notice the list of stored waveforms.

Example 9: Using the Disk Drive to Store Waveforms

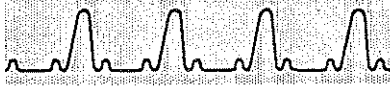



Glossary



Acquisition

The process of sampling the signals coming through input channels, and accumulating the samples into waveforms.

Active Graticule

The graticule in a dual-graticule display that shows the selected waveform.

Annotation Lines

Lines that appear on a waveform to show the measurement parameters.

Autoset

A means of letting the DSA set itself to provide a stable and meaningful display of a given waveform.

Averaging

Displaying a waveform that is the combined result of several acquisitions, thereby reducing apparent noise.

Axis Label

There are three notations on each axis. The first and last notation on each axis show the numeric value of the graticule edge (*not* the edge of the displayed points, which are slightly outside the graticule). The center notation is the scale factor expressed in units per division.

Channel

The input connector on a plug-in unit, to which you attach a probe or cable connected to the signal source. Also, the smallest component of a waveform expression.

Channel Number

The number assigned to a specific signal input connector. It always has two parts: a letter designating the plug-in compartment (L, C, or R), and a number designating the channel of the plug-in unit.



Complex Waveform

A waveform with a waveform description beyond a single channel specification. Any waveform using a numeric value, a function, a reference to a stored waveform, or an arithmetic operator is a complex waveform. However, using the average function does not make a waveform complex.

Control Knob

see Knob

Cursor

Any of four styles of paired markers that you position with the knobs. The DSA displays the positions of the cursors and the distance between them, in axis units.

Default Measurement Parameter

A value from the default set of measurement parameters. The operator can change the default values. Whenever a waveform is created, the measurement parameters are copied from the default set.

Disk

The DSA floppy disk drive enables storing waveforms and settings to PC compatible floppy disks.

Dragging

The act of changing your touch panel selection by moving your finger without removing it from the display. The selection that is activated is the last one that you were touching before removing your finger from the display.

Dual Graticule

A display with two graticules. Each one is half the height of the single graticule.

Entry Line

A text line that shows your input as you enter selections in a pop-up menu.

**Enveloping**

Displaying a waveform that shows the extremes of variation of several acquisitions.

GPIB (General Purpose Interface Bus)

An interface that allows remote computer control of, and data capture from, the DSA.

Graticule

The grid where waveforms are displayed.

Icon

A marker on the edge of the graticule that performs a specific function when touched.

Initialization

Setting the DSA to a completely known, default condition.

Keypad Menu

- A pop-up menu that controls knob resolution and lets you enter specific numeric values for any control to which a knob is assigned.

Knob

One of the two large rotary controls below the DSA screen.

Knob Assignment

The value that a knob will adjust at a given time.

Knob Menu

The on-screen menu that always displays the current knob assignment. The knob menu also lets you display the Keypad menu.

Knob Parameter

see Knob Assignment

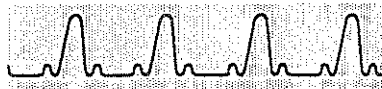
**Label**

An identifying word associated with a waveform or a stored setting. Waveform labels can be displayed with their waveforms.

Major Menu

The menu that is displayed at the bottom of the screen alongside the Knob menu. One of the several major menus is always displayed.

Major Menu Button

A labeled button to the right of the screen that determines which major menu is displayed.

Measurement

An automated numeric readout that the DSA provides directly from the displayed waveform and updates in real time.

Measurement Parameter

One of several controls that you can exercise over the automated measurement process.

Measurement Statistics

One of several controls, including reference values and limits, that determine how measurements are taken. You can change these parameters to control the automated measurements.

Measurement Statistics

One of several controls, including reference values and limits, that determine how measurements are taken. You can change these parameters to control the automated measurements.

Outline Box

A visual feedback mechanism of the touch panel. Your potential selection is always indicated by a box while your finger is touching the screen.

**Plug-In Amplifier**

An amplifier that scales the incoming signal of a channel before sending it to the DSA to be digitized.

Pocket Signal Generator

A device that attaches to the DSA and provides all the signals needed to perform the examples in this Tutorial.

Persistence Mode

A mode of operation where the DSA displays newly acquired waveform data points and keeps the previously acquired data points on the screen.

Pop-up Menu

A temporary menu that provides an interactive dialog for a specific purpose. A sub-menu of a major menu.

Principal Power Switch

The master power switch located on the rear panel of the DSA.

RAM

Random Access Memory.

Record Length

The number of samples (data points) that make up a waveform.

RS-232-C

A serial interface that allows remote computer control of, and data capture from, the DSA.

Selected Waveform

The waveform that is acted on by the knobs and menu selectors, and to which measurement readouts apply.

Selector

An area of a menu that performs some action when you touch it.

**Setting**

The state of the system at a given time.

Stored Waveform

A collection of sampled points that constitute a single waveform acquisition that is saved in memory.

Time Base

The time-dependent specifications that control the acquisition of a waveform. The time base determines when and for how long to acquire and digitize signal data points.

Trigger

An electrical event that is used as a horizontal reference for acquired waveform samplers.

Vertical Description

see Waveform Description

Waveform

The visible representation of an input signal or combination of signals.

Waveform Description

The definition of what the waveform displays. It can include one or more channels combined arithmetically and modified by functions.

Waveform Number

A number assigned by the DSA to identify a waveform. Displayed waveforms are numbered 1 through 8. A new waveform is always given the lowest available number.

Window

A waveform that represents a horizontally expanded portion of another waveform. Window waveforms are acquired using a time base that is independent of the Main time base.



Index



A

- Annotation Lines, 72–74
- Audio Feedback, 82
- Autoset, 20
 - options, 82, 84
- Averaging, 59–62
 - stopping acquisition when complete, 60–61

B

- B Sweep. *See Windows*
- Beep. *See Audio Feedback*
- Buttons
 - AUTOSET, 20
 - HARDCOPY, 10
 - MENUS, 15–16

C

- Calculated Waveforms, 49
- Calibrator, 8
- Channel Selection, 47–49, 51–52
- Clearing Waveforms, 94
- Connectors
 - GPIB, 10
 - power, 9
 - printer, 10
 - RS-232-C, 10
- Creating Waveforms, 20, 30–32
- Cursors, 84–89, 91
 - accuracy, 91
 - split dots, 88–89
 - types, 85–86, 88



D

Default Parameters. *See Measurements*

Delayed Sweep. *See Windows*

Deleting Waveforms, 40, 94

Digitizing

 Definition, 5

 Rate, 3

 Setting Points per Trace, 63

Directory Operations, 102–103

Disk Operations, 100–102

Displaying Waveforms, 20, 30–32

E

Enhanced Accuracy, 82

Enveloping, 59, 61–62

 stopping acquisition when complete, 60–61

Equivalent Time, 5

F

Fast, 49, 82

File Operations, 104–112

Front-Panel Settings, 94

G

GPIB, 4, 10, 63

Graticules

 active, 39

 dual, 38–40, 51



H

Hardcopy, 10
High Prec, 49, 82
Horizontal Adjustment, 23, 51

I

Icons

- Cursors, 24, 84–89, 91
- Def Wfm, 24, 43–45
- horizontal, 23–24, 51
- trigger, 20, 23–24
- vertical, 23–24, 46–49
- Window, 24, 50–52, 54
- Window 2, 51

Initialize, 16–19

K

Keypad Menu

- knob resolution, 25–26
- numeric entry, 27

Knobs

- assignment, 22–23, 27
- clicks, 22–23
- keypad menu, 25–27
- label, 22
- labels, 22–23
- menu, 22, 25–27
- resolution, 25–26

L

Labels, Waveform, 35, 37–38

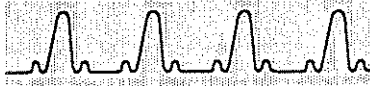

M

Main Position, 22

Main Size, 22

Main Time Base, 22, 32

Measurements

annotations, 72, 73, 74

automated, 68–70, 7–76, 78–79, 88

comparing to a reference, 78–79

default parameters, 74–76

parameters, 72–74

reference, 78–79

specifying, 68–70

Menu

knob menu, 25–27

major menu button, 15–16

pop-up, 25

selector, 18–19

N

Numeric Entry, 27

O

Options, 82–84

P

Plug-In Unit

buttons, 20, 40

compartments, 8

connectors, 19

installation, 8

lights, 20, 32, 40

Pocket Signal Generator, 13

Point Accumulate, 56–59

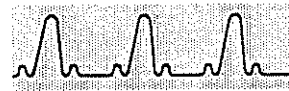

Points per Trace, 63

Power

line voltage selector, 9

ON/STANDBY switch, 11

plug, 9

power-on, 11

PRINCIPAL POWER SWITCH, 9, 11

Printer, 10

R

Real Time, 5

Record Length, 63

Removing Waveforms, 40, 94

RS-232-C, 4, 10, 63

S

Safety, 6–7

Selector. *See Menu, selector*

Settings, storing, 94

Signal Processing

averaging, 59–62

enveloping, 59, 61–62

stopping acquisition when complete, 60–61

Specifications, 3–4

Storing

settings, 94

waveforms, 94–97, 100, 105–106, 108

T

Time Bases, 32, 51

Touch Panel, Touch Screen, 18

Touching

selectors, 18



waveforms, 32

Trace Separation, 51–52

Trigger

auto, 42

icon, 20, 23

indicator, 20, 23

level, 23

V

Vectored Waveforms, 82

Vertical Adjustment, 23, 46–49

channel selection, 47–48

Vertical Description, 32–34, 43–45

W

waveform labels, labels, 38

Waveform Scaling, 82

Waveforms

averaging, 59–62

calculated, 49

clearing, 94

complex, 43–49

creating, 20, 30–32, 43–45

deleting, 40, 94

description, 32–34, 43–45

enveloping, 59, 61–62

labels, 35, 37–38

numbers, 33

point accumulate display, 56–59

removing, 40, 94

scaling, 82

selected, 32–34

selecting, 34

selecting by touch, 32

status, 32–34

stored, 94–97, 100, 105–106, 108

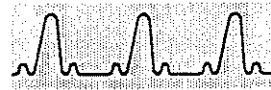

vertical separation, 51 – 52
Window, 50 – 52, 54
position, 51
size, 51
time base, 51
vertical separation, 51 – 52

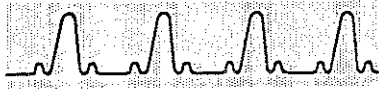

TEKTRONIX

DSA 601A & 602A
DIGITIZING SIGNAL ANALYZERS

TUTORIAL MANUAL

070-8180-00



Data Services

Free Manuals Download Website

<http://myh66.com>

<http://usermanuals.us>

<http://www.somanuals.com>

<http://www.4manuals.cc>

<http://www.manual-lib.com>

<http://www.404manual.com>

<http://www.luxmanual.com>

<http://aubethermostatmanual.com>

Golf course search by state

<http://golfingnear.com>

Email search by domain

<http://emailbydomain.com>

Auto manuals search

<http://auto.somanuals.com>

TV manuals search

<http://tv.somanuals.com>