TEK

Service Reference

Part No. 070-6787-01
Product Group 47

**THE
11A71**

AMPLIFIER

WARNING

The following servicing instructions are for use by qualified personnel only. To avoid personal injury, do not perform any servicing unless you are qualified to do so. Refer to the Safety Summary prior to performing any service.

Please check for CHANGE INFORMATION at the rear of this manual.

Tektronix
COMMITTED TO EXCELLENCE

0-1
 0-2
 0-3
 0-4
 0-5
 0-6
 0-7
 0-8
 0-9
 1-1
 1-2
 1-3
 1-4
 1-5
 1-6
 1-7
 1-8
 1-9
 2-1
 2-2
 2-3
 2-4
 2-5
 2-6
 2-7
 2-8
 2-9
 3-1
 3-2
 3-3
 3-4
 3-5
 3-6
 3-7
 3-8
 3-9
 4-1
 4-2
 4-3
 4-4
 4-5
 4-6
 4-7
 4-8
 4-9
 5-1
 5-2
 5-3
 5-4
 5-5
 5-6
 5-7
 5-8
 5-9
 6-1
 6-2
 6-3
 6-4
 6-5
 6-6
 6-7
 6-8
 6-9
 7-1
 7-2
 7-3
 7-4
 7-5
 7-6
 7-7
 7-8
 7-9
 8-1
 8-2
 8-3
 8-4
 8-5
 8-6
 8-7
 8-8
 8-9
 9-1
 9-2
 9-3
 9-4
 9-5
 9-6
 9-7
 9-8
 9-9

Instrument Serial Numbers

Each instrument manufactured by Tektronix has a serial number on a panel insert or tag, stamped on the chassis. The first letter in the serial number designates the country of manufacture. The last five digits of the serial number are assigned sequentially and are unique to each instrument. Those manufactured in the United States have six unique digits. The country of manufacture is identified as follows:

B010000	Tektronix, Inc., Beaverton, Oregon, USA
G100000	Tektronix Guernsey, Ltd., Channel Islands
E200000	Tektronix United Kingdom, Ltd., London
J300000	Sony/Tektronix, Japan
H700000	Tektronix Holland, NV, Heerenveen, The Netherlands

Instruments manufactured for Tektronix by external vendors outside the United States are assigned a two digit alpha code to identify the country of manufacture (e.g., JP for Japan, HK for Hong Kong, etc.).

Tektronix, Inc., P.O. Box 500, Beaverton, OR 97077

Copyright © Tektronix, Inc., 1987, 1989. All rights reserved. Tektronix products are covered by U.S. and foreign patents, issued and pending. The following are registered trademarks: TEKTRONIX, TEK, TEKPROBE, SCOPEMOBILE and



Contents

General Information

Safety Summary	1-2
Terms in Manuals	1-2
Terms on Equipment	1-2
Symbols in Manuals	1-2
Symbols on Equipment	1-2
Power Source	1-2
Grounding the Product	1-2
Danger Arising from Loss of Ground	1-3
Do Not Operate in Explosive Atmospheres	1-3
Do Not Service Alone	1-3
Use Care When Servicing with Power On	1-3
Plug-in to Mainframe Compatibility	1-3
Installing and Removing the Plug-in	1-4
Instrument Options	1-5
Packaging for Shipment	1-5
Operating Environment	1-5

Checks and Adjustments

Using These Procedures	2-7
Conventions in this Manual	2-7
Initialized Setting	2-7
Menu Selections and Measurement Techniques	2-7
Part 1 Initial Setup	2-8
Procedure	2-8
Diagnostics	2-8
New Configuration Calibration	2-9
Completion	2-9
Part 2 Enhanced Accuracy	2-10
Specifications	2-10
Setup to Check Enhanced Accuracy	2-10
Procedure to Check Enhanced Accuracy	2-10
Part 3 Trigger Balance and Common Mode	2-12
Measurement Limit	2-12
Setup to Examine/Adjust Trigger Balance and Common Mode	2-12
Procedure to Examine/Adjust Trigger Balance and Common Mode	2-12
Part 4 Input Current and Impedance	2-14
Measurement Limits	2-14
Setup to Examine/Adjust Input Current and Impedance	2-14
Procedure to Examine/Adjust Input Current and Impedance	2-14
Part 5a Low-Frequency Transient Response: Standard Procedure	2-16
Measurement Limit	2-16
Setup to Examine/Adjust Low-Frequency Transient Response: Standard Procedure	2-16
Procedure to Examine/Adjust Low-Frequency Transient Response: Standard Procedure	2-16

Checks and Adjustments (cont)

Part 5b Low-Frequency Transient Response: Alternate Procedure	2-19
Measurement Limit	2-19
Setup to Examine/Adjust Low-Frequency Transient Response:	
Alternate Procedure	2-19
Procedure to Examine/Adjust Low-Frequency Transient Response:	
Alternate Procedure	2-19
Part 6 Bandwidth	2-21
Specifications (Performance Verification)	2-21
Specifications (Functional Test)	2-21
Setup to Examine Mainframe Bandwidth	2-21
Procedure to Examine Mainframe Bandwidth	2-21
Setup to Check Amplifier Bandwidth: Performance Verification	
Procedure	2-23
Procedure to Check Amplifier Bandwidth: Performance Verification	
Procedure	2-23
Setup to Check Amplifier Bandwidth: Functional Test Procedure	2-25
Procedure to Check Amplifier Bandwidth: Functional Test Procedure	2-25
Part 7 Overload	2-26
Specification	2-26
Setup to Check Overload	2-26
Procedure to Check Overload	2-26
Part 8 Input Resistance	2-27
Specification	2-27
Setup to Check Input Resistance	2-27
Procedure to Check Input Resistance	2-27
Part 9 Vertical Accuracy	2-28
Specifications	2-28
Setup to Check Vertical Accuracy	2-28
Procedure to Check Vertical Accuracy	2-28
Check DC Balance—by performing Step 2.	2-28
Check Gain—by performing Steps 3 through 7.	2-29
Part 10 AC Coupling	2-30
Specifications	2-30
Setup to Check AC Coupling	2-30
Procedure to Check AC Coupling	2-30
Part 11 DC Balance	2-32
Specification	2-32
Setup to Check DC Balance	2-32
Procedure to Check DC Balance	2-32
Part 12a ΔV DC Accuracy: 11400-Series Mainframe Procedure	2-33
Specification	2-33
Setup to Characterize the 11400-Series Mainframe	2-33
Procedure to Characterize the 11400-Series Mainframe	2-33
Setup to Check the Amplifier DV DC Accuracy	2-34
Procedure to Check the Amplifier DV DC Accuracy	2-34
Part 12b ΔV DC Accuracy: 11300-Series Mainframe Procedure	2-37
Specification	2-37
Setup to Characterize the 11300-Series Mainframe	2-37
Procedure to Characterize the 11300-Series Mainframe	2-37
Setup to Check the Amplifier DV DC Accuracy	2-38
Procedure to Check the Amplifier DV DC Accuracy	2-39

Checks and Adjustments (cont)	
Part 13 DC Offset Accuracy	2-41
Specifications	2-41
Setup to Characterize the 11400-Series Mainframe	2-41
Procedure to Characterize the 11400-Series Mainframe	2-41
Setup to Characterize the 11300-Series Mainframe	2-42
Procedure to Characterize the 11300-Series Mainframe	2-42
Setup to Check the Amplifier DV DC Offset Accuracy	2-43
Procedure to Check the Amplifier DV DC Offset Accuracy	2-44
Maintenance	
Preventive Maintenance	3-1
Amplifier Shield Removal	3-1
Cleaning	3-1
Visual Inspection	3-2
Periodic Electrical Adjustment	3-2
Corrective Maintenance	3-3
Ordering Parts	3-3
Static-Sensitive Device Classification	3-3
Removing and Replacing FRUs	3-4
Removing/Replacing FRU ICs	3-6
Removing/Replacing the U350 Hypcon Assembly	3-8
Circuit Board and Attenuator FRU Removal	3-12
Programming The Unit Identification	3-16
BNC Connectors	3-17
Multi-Pin Connectors	3-18
Diagnostic Troubleshooting	3-19
Diagnostics Overview	3-19
New Configuration Calibration	3-22
Restoring Calibration Data	3-22
Amplifier Memory Backup Power	3-23
Field Replaceable Unit (FRU) Guide	3-23
Fuse Troubleshooting	3-26
Jumpers	3-26
Theory of Operation	
Block Diagram Description	4-1
Signal Flow	4-1
Power	4-3
Replaceable Parts	
Parts Ordering Information	5-1
Module Replacement	5-1
Using the Replaceable Parts List	5-2
Item Names	5-2
Indentation System	5-2
Abbreviations	5-2
Change Information	

List of Illustrations

Figure 1-1	Installing the 11A71 Amplifier in a Mainframe	1-4
Figure 2-1	A1 Main Board Trigger Balance Test Point and Adjustment Locations	2-13
Figure 2-2	A1 Main Board Input Current and Impedance Adjustment Locations	2-15
Figure 2-3	A1 Main Board Low-Frequency Response Adjustment Locations	2-18
Figure 2-4	Waveform with AC Coupling Selected	2-31
Figure 3-1	Field Replaceable Units (FRU) Locator and A1 Main Board Securing Hardware	3-5
Figure 3-2	Semiconductor Indexing Diagram	3-7
Figure 3-3	Hypcon Assembly Removal and Replacement	3-10
Figure 3-4	IC Insertion-Extraction Pliers	3-11
Figure 3-5	Location of Screws and Parts for Removal of an Attenuator ..	3-14
Figure 3-6	Location of a Nut Block Securing the Circuit Board to the Frame Section	3-16
Figure 3-7	Locations of the Nut Blocks for Removal of the A1 Main Board	3-16
Figure 3-8	Indexing of Multi-pin Connectors	3-18
Figure 3-9	Sample LED Fault Code Timing Diagram	3-20
Figure 4-1	11A71 Amplifier Block Diagram	4-2

List of Tables

Table 2-1	Measurement Limits, Specifications, Adjustments, and Functional Test	2-1
Table 2-2	Test Equipment	2-4
Table 2-3	11A71 Amplifier Bandwidth in the 11402 or 11403 Mainframe ..	2-24
Table 2-4	11A71 Amplifier Bandwidth in the 11401 or 11300-Series Mainframes	2-24
Table 2-5	11A71 Amplifier DC Offset Accuracy	2-45
Table 3-1	Relative Susceptibility to Damage from Static Discharge	3-4
Table 3-2	Board FRU	3-23
Table 3-3	Component/Module FRUs	3-24
Table 3-4	Amplifier Kernel Error Index Codes	3-24
Table 3-5	Self-Tests/Extended Diagnostics Error Index Codes	3-25
Table 3-6	Self-Tests/Extended Diagnostics Error Index Codes	3-25

General Information

This manual is designed for use by qualified service personnel. It contains information necessary to check, maintain and troubleshoot the 11A71 Amplifier.

Troubleshooting is primarily based upon internal diagnostics. These diagnostics isolate problems to the field replaceable unit (FRU) level. Once the faulty FRU is identified, use the procedures in this manual to remove and replace the faulty FRU. Section 5, Replaceable Parts gives a complete list of the FRUs in this amplifier.

The 11A71 is a single-channel, wide-bandwidth, amplifier that plugs into any of the 11000-Series Oscilloscope mainframes that use amplifiers. Commands from the mainframe control all the functions of the amplifier. The front panel of the amplifier has a button and a LED indicator for each input channel. Other controls and status indicators are located on the mainframe.

The impedance of the input is 50 Ω . The amplifier provides display and trigger signals to the mainframe.

The amplifier has a TEKPROBE® input connector. The TEKPROBE® input connector is compatible with a Level 1 or Level 2 TEKPROBE®, a probe with a BNC connector, or a BNC connector. When a probe is connected to the input connector, the amplifier will detect the probe-encoding information, and use this information to automatically achieve the appropriate settings.

Safety Summary

This general safety information is directed to operators and service personnel. Specific warnings and cautions will be found throughout the manual where they apply, but may not appear in this summary.

Terms in Manuals

CAUTION statements in manuals identify conditions or practices that could result in damage to the equipment or other property.

WARNING statements in manuals identify conditions or practices that could result in personal injury or loss of life.

Terms on Equipment

CAUTION on equipment means a personal injury hazard not immediately accessible as one reads the marking, or a hazard to property, including the equipment itself.

DANGER on equipment means a personal injury hazard immediately accessible as one reads the marking.

Symbols in Manuals



Static Sensitive Devices

Symbols on Equipment



DANGER
High Voltage



*Protective
ground (earth)
terminal*



ATTENTION
*Refer to
manual*

Power Source

This amplifier is intended to operate in a mainframe connected to a power source that will not apply more than 250 V rms between the supply conductors or between either supply conductor and ground. A protective ground connection, by way of the grounding conductor in the mainframe power cord, is essential for safe system operation.

Grounding the Product

This amplifier is grounded through the grounding conductor of the mainframe power cord. To avoid electric shock, plug the mainframe power cord into a properly wired receptacle before connecting the mainframe to the input or output terminals of the amplifier. A protective-ground connection, by way of the grounding conductor in the mainframe power cord, is essential for safe operation.

Danger Arising from Loss of Ground

Upon loss of the protective-ground connection, all accessible conductive parts (including knobs and controls that may appear to be insulating), can render an electric shock.

Do Not Operate in Explosive Atmospheres

To avoid explosion, do not operate this product in an atmosphere of explosive gasses.

Do Not Service Alone

Do not perform internal service or adjustment of this product unless another person capable of rendering first aid and resuscitation is present.

Use Care When Servicing with Power On

Dangerous voltages exist at several points in this product. To avoid personal injury, do not touch exposed connections and components while the power is on.

Disconnect the power before removing protective panels, or replacing components.

Plug-in to Mainframe Compatibility

The system bandwidth depends on the mainframe. Details about bandwidth are included in Part 4, Specification, of the *11A71 User's Reference Supplement*, and in the *Tektronix Corporate Catalog*. Refer to the *Tektronix Corporate Catalog* for complete compatibility information.

Installing and Removing the Plug-in

Install the amplifier in any 11000-Series Oscilloscope mainframe as follows:

1. Set the mainframe ON/STANDBY switch to STANDBY to prevent damage to the mainframe.

If the green indicator light remains ON when the STANDBY position is selected, then the switch has been left internally disabled after the servicing of the power supply. To enable the ON/STANDBY switch, refer to the Maintenance section of the mainframe Service Manual.

2. Align the grooves in the top and bottom of the amplifier with the guides in the mainframe plug-in compartment.
3. Insert the amplifier into the mainframe until its front panel is flush with the front panel of the mainframe.

Remove the amplifier from an 11000-Series Oscilloscope mainframe as follows:

1. Set the mainframe ON/STANDBY switch to STANDBY to prevent damage to the mainframe.
2. Pull the release latch (see Fig. 1-1) to disengage the amplifier from the mainframe.
3. Pull the amplifier straight out of the plug-in compartment.

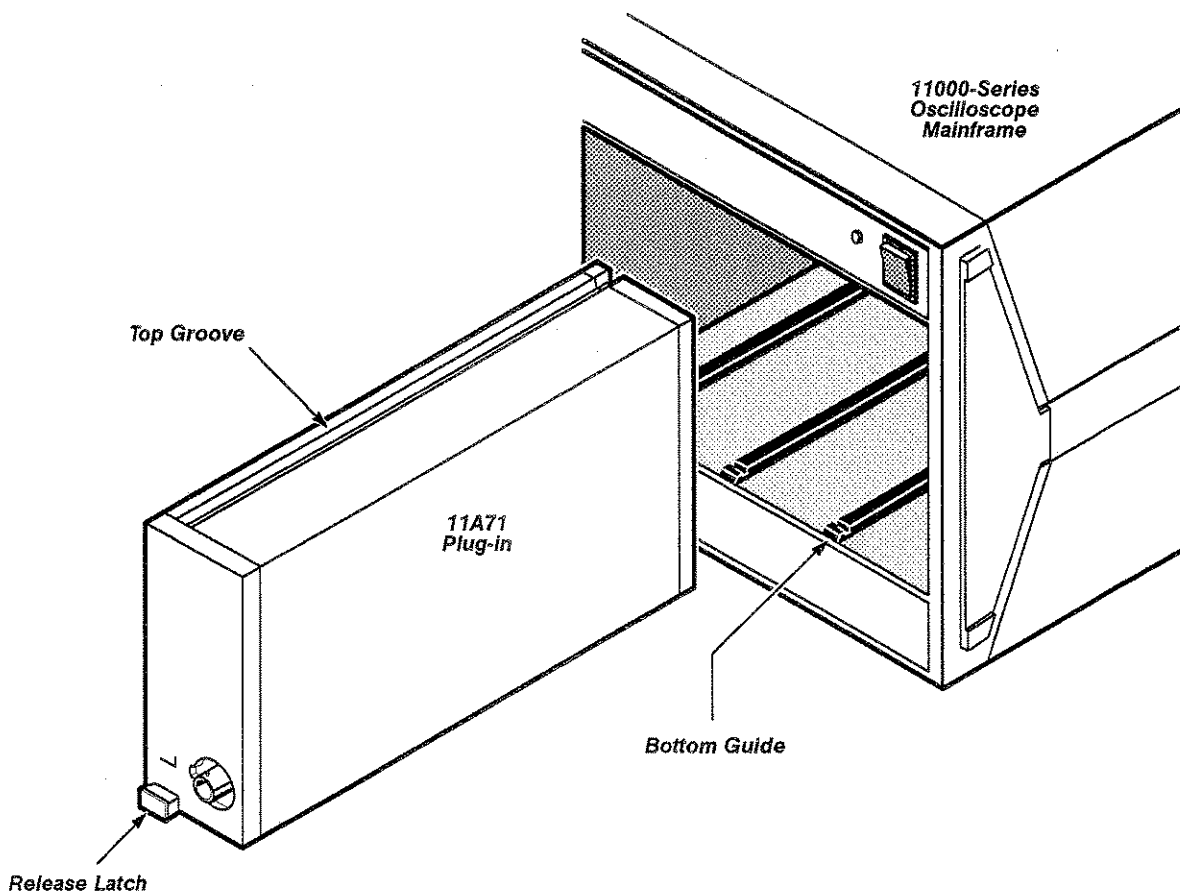

Figure 1-1 — Installing the 11A71 Amplifier in a Mainframe

Instrument Options

The customer can order Option 26, which includes one P6231 probe.

Packaging for Shipment

If possible, save and reuse the original carton and packaging to package the instrument when shipping it by commercial transportation. Package and ship amplifiers and mainframes separately.

Attach a tag to the amplifier if it is shipped to a Tektronix service center for service or repair. Include the following information on the tag:

- Name and address of the amplifier owner
- Name of a person at your firm who can be contacted about the amplifier
- Complete amplifier type and serial number
- A description of the service required

Package the amplifier as follows, if the original package is not available or is not reusable:

1. Obtain a corrugated cardboard carton with inside dimensions at least six inches (15 cm) greater than the amplifier dimensions. Use a carton with a bursting test strength of at least 200 pounds per square-inch.
2. Fully wrap the amplifier with anti-static sheeting, or its equivalent, to protect the finish.
3. Tightly pack dunnage or urethane foam between the carton and the amplifier to cushion the amplifier on all sides. Allow three inches of packing on each side.
4. Seal the carton with shipping tape or with industrial staples.
5. Mark the address of the Tektronix service center and your return address on the carton in one or more prominent places.

Operating Environment

The following environmental requirements are provided so that you can ensure proper functioning and extend the operation of the amplifier:

- Operate the amplifier in a mainframe where the ambient air temperature is between 0° and +50°C.
- Store the amplifier in ambient temperatures from -40° to +75°C.
- After storing the amplifier at temperatures outside the operating limits, allow the amplifier to reach the safe operating temperature before installing it in the mainframe, and applying power to the mainframe.

Enhanced system accuracy is available after a 20-minute warmup period. If the mainframe is in the Enhanced Accuracy state and the internal temperature of the mainframe changes $\pm 5^{\circ}\text{C}$, the mainframe reverts to normal accuracy.

Checks and Adjustments

This section contains procedures to examine measurement limits, check electrical specifications, and to manually set all internal adjustments. This procedure provides a logical sequence of check and adjustment steps, and is intended to return the amplifier to specified operation following repair, or as a part of a routine maintenance program. To functionally test the oscilloscope, perform the parts which have a "yes" indication in the Functional Test column of Table 2-1, Measurement Limits, Specifications, Adjustments and Functional Test.

Refer to the *11A71 User's Reference Supplement* for more information about advertised specifications and amplifier operation. At the beginning of each part the specifications or measurement limits are given. Then, the setup for each procedure in that part provides information concerning test equipment setup or interconnection. Refer to Table 2-2, Test Equipment for more information concerning test equipment used in these setups.

Table 2-1 — Measurement Limits, Specifications, Adjustments, and Functional Test

Part and Description	Measurement Limits (<i>Examine</i>)	Specifications (<i>Check</i>)	Adjustments (<i>Adjust</i>)	Functional Test
Part 1 Initial Setup	none	none	none	yes
Part 2 Enhanced Accuracy	none	successful execution		yes
Part 3 Trigger Balance and Common Mode	Balance = 0.0 ± 20 mV	none	R813 TRIGGER BAL to 0.0 ± 20 mV	no
Part 4 Input Current and Impedance	Input resistance = $50 \pm 1 \Omega$ Open circuit input voltage = 0 ± 2.0 mV	none	R521 INPUT I for 0.0 mV R511 Z IN for 50.0Ω	no
Part 5a Low-Frequency Transient Response: Standard Procedure	Square-wave aberrations with +1% and -0.5% peak	none	R410 and R411 for a flat top on the dim waveform R311 and R312 for optimum square-wave flat top R310, R510, and C412 for optimum square-wave flat top	no

Table 2-1 — Measurement Limits, Specifications, Adjustments, and Functional Test (cont)

Part and Description	Measurement Limits (Examine)	Specifications (Check)	Adjustments (Adjust)	Functional Test
Part 5b Low-Frequency Transient Response: Alternate Procedure	waveform with flat top (minimum long-term spiking and rolloff)	none	R410 and R411 for a flat top on the dim waveform R311 and R312 for optimum square-wave flat top R310, R510, and C412 for optimum square-wave flat top	no
Part 6 Bandwidth				
Amplifier Bandwidth: Performance Verification Procedure	none	refer to Table 2-3 or 2-4 for the bandwidth specifications	none	no
Amplifier Bandwidth: Functional Test Procedure	none	peak-peak measurement ≥ 848 mV	none	yes
Part 7 Overload	none	coupling changes to off	none	yes
Part 8 Input Resistance	none	$50 \Omega \pm 0.5 \Omega$	none	yes
Part 9 Vertical Accuracy				
DC Balance	none	from 10 mV to 1 V, trace within ± 0.2 divs of center.	none	
Gain	none	peak-peak measurement is 5 V ± 95 mV for the 11300-Series and 5 V ± 65 mV for the 11400-Series	none	yes
Part 10 AC Coupling	none	bottom of square wave near center graticule line and waveform centered on screen (see Fig. 2-4)	none	yes
Part 11 DC Balance	none	Balance within ± 0.2 division	none	no

Table 2-1 – Measurement Limits, Specifications, Adjustments, and Functional Test (cont)

Part and Description	Measurement Limits (Examine)	Specifications (Check)	Adjustments (Adjust)	Functional Test
Part 12a ΔV DC Accuracy: 11400-Series Mainframe Procedure	none	within $\pm 0.8\%$	none	no
Part 12b ΔV DC Accuracy: 11300-Series Mainframe Procedure	none	within $\pm 1.5\%$	none	no
Part 13 DC Offset Accuracy	none	refer to Table 2-5	none	no

Table 2-2, Test Equipment, lists recommended test equipment for use in this manual. The Functional Test column of Table 2-2 indicates, with a check mark (✓), the test equipment that is recommended if you are only performing a functional test. Procedure steps are based on the test equipment examples given, but other equipment with similar specifications may be substituted. Test results, setup information, and related connectors and adapters may be altered if you use different equipment.

Table 2-2 – Test Equipment

Description	Minimum Specification	Examples of Recommended Test Equipment	Functional Test
11000-Series Oscilloscope mainframe that accommodates amplifiers	Tektronix mainframe that accommodates amplifiers	TEKTRONIX 11301 Programmable Oscilloscope 11302 Programmable Oscilloscope 11301A Counter Timer Oscilloscope 11302A Counter Timer Oscilloscope 11401 Digitizing Oscilloscope 11402 Digitizing Oscilloscope 11403 Digitizing Oscilloscope	✓
Note: <i>The Amplifier/Mainframe combination will determine system bandwidth.</i>			
Power Module	Tektronix four-compartment power module	TEKTRONIX TM 504 Power Module	✓
Leveled Sine Wave Generators	250 MHz to 1000 MHz, Leveled variable amplitude, 50 kHz or 6 MHz reference	TEKTRONIX SG 504 Leveled Sine Wave Generator with a TM 500-Series Power Module	✓
	260 kHz to 250 MHz, Leveled variable amplitude, 50 kHz or 6 MHz reference	TEKTRONIX SG 503 Leveled Sine Wave Generator with a TM 500-Series Power Module	✓
Power Supply	Continuously variable from 0–40 V; current limit, adjustable from 0–400 mA; 20 V at 400 mA with overcurrent protection	TEKTRONIX PS 503A Dual Power Supply with a TM 500-Series Power Module	✓
DC Voltage Calibrator (optional)	Output, 0–4 V	Data Precision 8200	CG 5001 FLUKE 5101B
Pulser	Amplitude: 250 mV Rise time: ≤125 ps Aberrations: < 1%	TEKTRONIX 067-0681-01 Tunnel diode Calibration Fixture	CG 5001 10/12/13 + 1/2 lead

Table 2-2 – Test Equipment (cont)

Description	Minimum Specification	Examples of Recommended Test Equipment	Functional Test
Digital Multimeter (w/test leads)	Accuracy $\leq 0.01\%$ 5 1/2 digit, 0.01% DC volts and 0.1% resistance accuracy, 4-wire resistance measurement	Fluke 8842A Digital Multimeter <i>8502A</i>	✓ <i>need to get</i>
Signal Standardizer	Tektronix Calibration Fixture with interface connector modified for 11000-Series use	TEKTRONIX 067-0587-02 Signal Standardizer	✓
Calibration Generator	Period, 0.1 ms Amplitude, -60 V Square wave output, 0.25% accuracy, 1-2-5 amp selection from 200 μ V p-p to 100 p-p, ~ 1 ms period, fast rise < 1 ns	TEKTRONIX PG 506 Calibration Generator with a TM 500-Series Power Module <i>CG 5001</i>	✓
Calibration Fixture Flexible Extender		TEKTRONIX 067-1261-00 Calibration Generator with a TM 500-Series Power Module	✓
Coaxial Cable, 18-inch (2 required)	50 Ω , 18-inch male BNC connectors	Tektronix Part 012-0076-00	✓
Coaxial Cable, 36-inch (2 required)	50 Ω , 36-inch male BNC connectors	Tektronix Part 012-0482-00	✓
Coaxial Cable, 42-inch (2 required)	50 Ω , 42-inch male BNC connectors	Tektronix Part 012-0057-01	✓
Adapter, BNC to Alligator Clips	BNC Female to Clip leads	Tektronix Part 013-0076-00	✓
Attenuator, 10X	Impedance: 50 Ω , one male and one female BNC connector	Tektronix Part 011-0059-02	✓
Adapter, BNC-to-Banana (2 required)	BNC Female-to-Dual Banana Connector	Tektronix Part 103-0090-00	✓
Adapter, T	BNC, T: Two female and one male BNC connector	Tektronix Part 103-0030-00	✓
50 Ω Termination	Impedance: 50 Ω ; Accuracy, within 2%; connectors, BNC	Tektronix Part 011-0049-01	✓

Table 2-2 – Test Equipment (cont)

Description	Minimum Specification	Examples of Recommended Test Equipment	Functional Test
Resistor	430 Ω, 10% tolerance; power rating, 1 W	Tektronix Part 303-0431-00	✓
Alignment Tool (insulated slot)	Insulated slot	Tektronix Part 003-0675-01	✓
Magnetic Screwdriver	Holder for Torx tips	Tektronix Part 003-0293-00	✓
Torx Screwdriver Tips	#6 tip #7 tip #8 tip #10 tip #10 tip narrow shank #15 tip	Tektronix Part 003-1415-00 Tektronix Part 003-1293-00 Tektronix Part 003-0964-00 Tektronix Part 003-0814-00 Tektronix Part 003-0815-00 Tektronix Part 003-0966-00	✓ ✓ ✓ ✓ ✓ ✓
Integrated Circuit Extracting Tools	IC insertion-extraction pliers, 28-pin type	General Tool P/N U505BG or equivalent	
Needle-nose pliers			✓
Tweezers			✓
Static Control Mat		Tektronix Part 006-3414-00	not needed
Wrist Strap		Tektronix Part 006-3415-00	not needed

Using These Procedures

The first-time user should familiarize themselves with the proceeding information prior to performing the procedures in the parts that follow.

Conventions in this Manual

In these procedures, the following conventions are used:

- CAPITAL letters within the body of text identify front panel controls, indicators, and connectors (for example, MEASURE) on the mainframe and amplifier.
- **Bold** letters identify menu labels, display messages, and commands typed in from a terminal or controller.
- Initial Capital letters identify connectors, controls, and indicators (for example, Position) on associated test equipment. Initial Capital letters also identify adjustments inside the amplifier (for example Vert Pos).
- In some steps, the first word is italicized to identify a step that contains a performance verification and/or an adjustment instruction. For example, if *Check* is the first word in the title of a step, an electrical specification is checked. If *Adjust* appears in the title, the step involves an electrical adjustment. If *Examine* is the first word in the title, the step involves measurement limits that are used as calibration guides; these limits are not to be interpreted as electrical specifications.

A heading system is used to readily identify the steps that contain performance verification and/or adjustment instructions. For example, if *Check* is the first word in the title of a step, an electrical specification is checked. If *Adjust* appears in the title, the step involves an electrical adjustment. If *Examine* is the first word in the title, the step concerns measurement limits that indicate whether the instrument is operating properly; these limits are not to be interpreted as electrical specifications.

Initialized Setting

At the beginning of most steps, you are instructed to **Initialize** the instrument as part of the setup. The **Initialize** feature, available through the UTILITY menu, presets all mainframe controls and functions to known values. Initializing the instrument at the beginning of a step eliminates the possibility of settings from previous steps causing erroneous or confusing results. For more information on initialization, refer to the mainframe *User Reference* manual.

Menu Selections and Measurement Techniques

Details on measurement techniques and instructions for making menu selections are generally not included in this procedure. Comprehensive descriptions of menus and instrument features are located in the mainframe *User Reference* manual.

Part 1 Initial Setup

Perform the Checks and Adjustment procedure within the ambient temperature range of +18° and +28°C, to ensure proper mainframe and amplifier operation.

CAUTION

To avoid damage to any of the equipment, set the mainframe ON/STANDBY switch to STANDBY before installing or removing amplifiers.

- Step 1: Install the 11A71 Amplifier to be inspected in the mainframe's Center plug-in compartment, then set the front panel ON/STANDBY switch to ON.

CAUTION

Turning the mainframe power off during probe calibration, self-calibration, Extended Diagnostics, or other intense system activity may result in some internal data being corrupted. If corruption occurs, refer to Restoring Calibration Data in Section 3.

- Step 2: Power on the following test equipment, so that it is warmed up with the mainframe and amplifier to be tested.

Power supply
Calibration generator
Leveled sine wave generators
Digital multimeter

- Step 3: With the ON/STANDBY switch set to STANDBY, connect the mainframe to a suitable power source.
- Step 4: Set the front panel ON/STANDBY switch to ON.
- Step 5: Allow the equipment to warm up for 20 minutes before continuing.

Procedure

Each time the front-panel ON/STANDBY switch is set to ON, the mainframe performs comprehensive diagnostics on all of its major circuits.

Diagnostics

As the Diagnostics progress, relays will click and the screen will, at times, display various patterns. Successful completion of diagnostics is indicated by return to normal operation or entry into the new configuration calibration state, as discussed below. Any failures cause the mainframe to either display the diagnostics menu, which indicates the failed test, or lockup and light a combination of the major-menu button labels. If a diagnostics failure occurs, refer the mainframe to a qualified service person.

New Configuration Calibration

When an amplifier is first installed in a mainframe or when one is moved to a different compartment in the mainframe, the mainframe will be in a new configuration state. After the mainframe executes the diagnostics, it will recalibrate itself for the new configuration. During this calibration, the message **Powerup new configuration partial calibration occurring** will appear on the display. If the calibration is successful, as indicated by a message, the mainframe will enter the normal operating mode.

Completion

When the mainframe completes the diagnostics and the new configuration calibration without a failure, then it has passed this part of the procedure.

Part 2 Enhanced Accuracy

When displayed, the Enhanced Accuracy symbol (EA) indicates that the instrument is at its highest Accuracy state. The mainframe saves the time of calibration and ambient temperature for use in maintaining the Enhanced Accuracy state.

For more information about the Enhanced Accuracy state, see Enhanced Measurement Accuracy Indicator in the mainframe *User Reference* manual.

While Enhanced Accuracy is in effect, to verify the DC measurement accuracy of the amplifier and mainframe system, apply and monitor test voltages, and compare these test voltages with the measurements made on the screen.

Specifications

When invoked, the self-calibration activity executes successfully.

Setup to Check Enhanced Accuracy

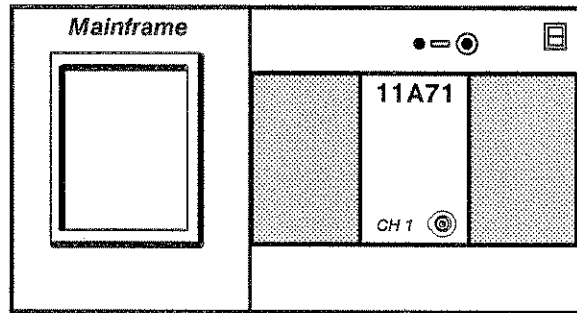

Setup to Check Enhanced Accuracy

Procedure to Check Enhanced Accuracy

- Step 1: **Initialize** the mainframe's settings.
 - Center plug-in no setting changes
 - Mainframe no setting changes
- Step 2: Twenty minutes after power-on, the mainframe must recalibrate itself to achieve the Enhanced Accuracy state. Press the ENHANCED ACCURACY button. A prompt then appears on the display. Press the ENHANCED ACCURACY button again. Enhanced Accuracy is achieved after a couple of minutes.



Turning the mainframe's power off during Enhanced Accuracy testing may result in losing some of the non-volatile RAM data. This could cause diagnostic errors at the next power-up, and cause the mainframe to operate unpredictably. If this event occurs, refer to Restoring Calibration Data in your mainframe's Service Reference manual.

- Step 3: Check that the message, **Enhanced Accuracy in Progress** (indicating that the mainframe is attempting to achieve Enhanced Accuracy) appears.
- Step 4: Check that the message, **Enhanced Accuracy completed and passed** or **Self calibration completed successfully** (indicating that the Enhanced Accuracy state has been achieved) appears. (The **EA** indicator appears on the display when Enhanced Accuracy is completed.)

Part 3 Trigger Balance and Common Mode

The Trigger Amplifier is adjusted for balance when the Vertical Amplifier output is balanced. The Common (Com) Mode adjustment, R812 (if installed), does not need adjustment.

Measurement Limit

Balance = 0.0 ± 25 mV.

Setup to Examine/Adjust Trigger Balance and Common Mode

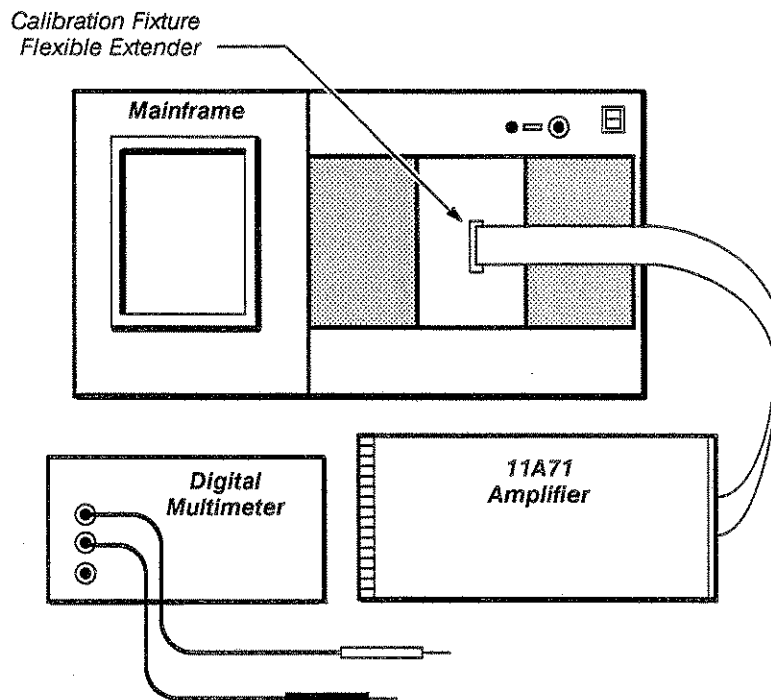

Setup to Examine/Adjust Trigger Balance and Common Mode

Procedure to Examine/Adjust Trigger Balance and Common Mode

- Step 1: Perform the following settings in the order listed:

Mainframe

ON/STANDBY ON

Wait for calibration cycle to complete.

UTILITY major menu **Initialize**

Center plug-in

CH 1 Display on/off on

Digital Multimeter (DMM) not connected yet

- Step 2: Connect the DMM leads to points K and M. See Figure 2-1 for test point locations.

- Step 3: Set the **Vert Offset: Fine**, for a DMM readout of $0\text{ mV} \pm 5\text{ mV}$.
- Step 4: Connect the DMM leads to points D and E. Refer to Figure 2-1 for test point locations.
- Step 5: *Examine* the DMM for a reading of 0 mV , within the limits of -20 mV and $+20\text{ mV}$.



DO NOT attempt to adjust the TRIGGER BAL if it is within the stated limits. Proceed to Step 7.

- Step 6: Adjust TRIGGER BAL adjustment, R813 on the A1 Main board, to $0 \pm 20\text{ mV}$. See Figure 2-1 for adjustment locations.
- Step 7: Set the ON/STANDBY switch to STANDBY. Remove the flexible extender from the mainframe and the amplifier

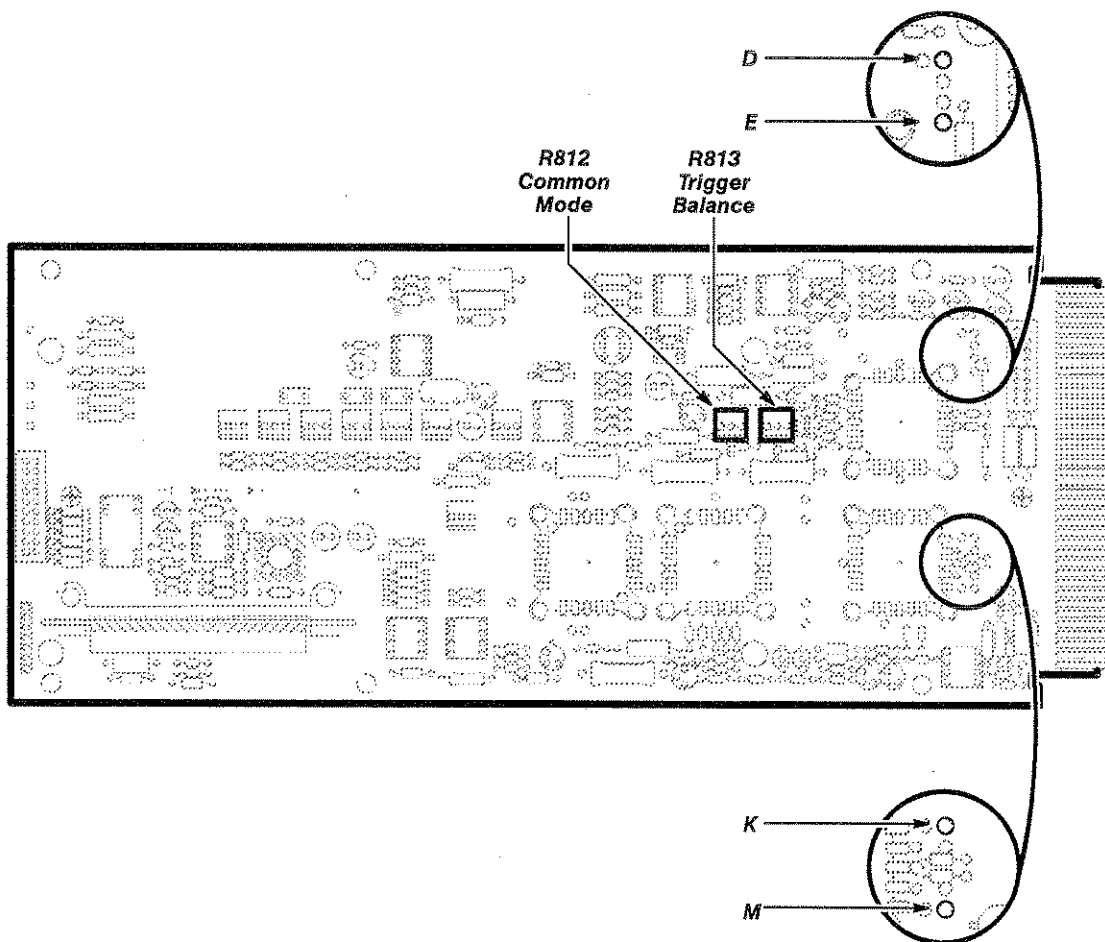

Figure 2-1 — A1 Main Board Trigger Balance Test Point and Adjustment Locations

Part 4 Input Current and Impedance

The fast protection circuit is adjusted for proper input impedance and minimum input current.

Measurement Limits

The measurement limits for this part are as follows:

- Input resistance = $50 \pm 1 \Omega$.
- Open circuit input voltage = $0 \pm 2.0 \text{ mV}$.

Setup to Examine/Adjust Input Current and Impedance

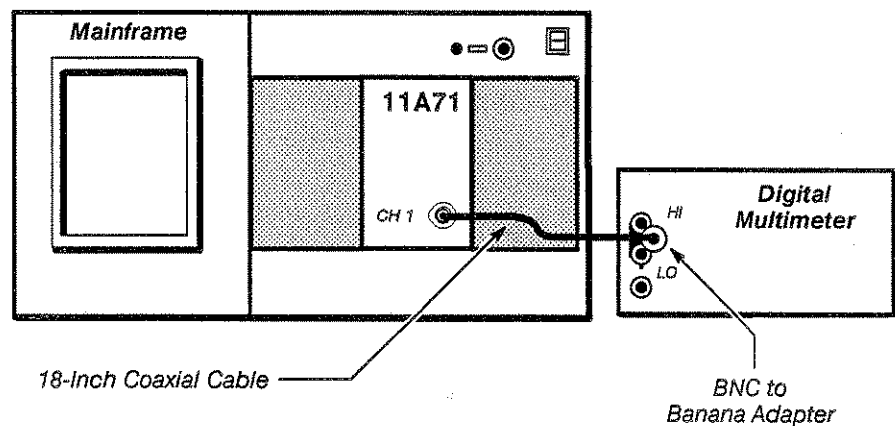

Setup to Examine/Adjust Input Current and Impedance

Procedure to Examine/Adjust Input Current and Impedance

- Step 1: Remove the top cover of the mainframe. Then, perform the following settings in the order listed:

Mainframe

ON/STANDBY ON

Wait for calibration cycle to complete.

UTILITY major menu **Initialize**

Signal standardizer

Not used in this procedure.

Center plug-in

CH 1 Display on/off on

Mainframe

Vert Size or VERTICAL SIZE 10 mV/div

Digital Multimeter (DMM)

Mode DC

Range 200 mV

- Step 2: *Examine* the DMM for a reading of 0.0 mV, within the limits of ± 2.0 mV.



DO NOT attempt to adjust the INPUT I if it is within the stated limits. Proceed to Step 9.

- Step 3: *Adjust* INPUT I adjustment, R521 on the A1 Main board, for 0.0 mV. See Figure 2-2 for adjustment locations.
- Step 4: Set the DMM to the 200 Ω range.
- Step 5: Read the DMM.
- Step 6: Reverse the BNC to banana connection on the DMM.
- Step 7: Read the DMM.
- Step 8: *Examine* the average DMM reading of Steps 5 and 7 for a value of 50.0 Ω , within the limits of 49.0 Ω and 51.0 Ω .

50 ± 0.5 Ω



DO NOT attempt to adjust the Z IN if it is within the stated limits. Proceed to Step 10.

- Step 9: *Adjust* Z IN adjustment, R511 on the A1 Main board, for 50.0 Ω . See Figure 2-2 for adjustment locations.
- Step 10: The adjustments in Step 2 and 9 are interactive (that is, adjusting one may affect the adjustment of the other); therefore repeat Steps 1 through 9 until both Steps 2 and 8 yield readings within the stated limits.

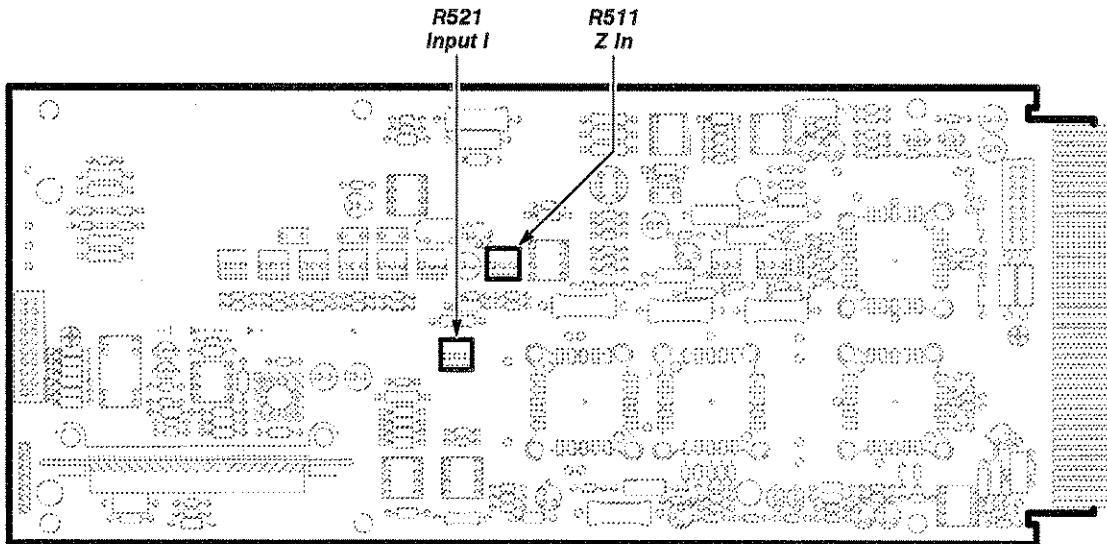

Figure 2-2 – A1 Main Board Input Current and Impedance Adjustment Locations

Part 5a
Low-Frequency
Transient Response:
 Standard Procedure

Compensation networks are adjusted to optimize the transient response. The Standard Procedure requires the use of an 11400-Series mainframe to assure that the amplifier performs properly in any mainframe. If neither an 11400-Series mainframe is available, then use the Alternative Procedure at the end of this part.

Measurement Limit

Square-wave aberrations within + 1% and -0.5% peak.

Setup to Examine/Adjust Low-Frequency Transient Response:
 Standard Procedure

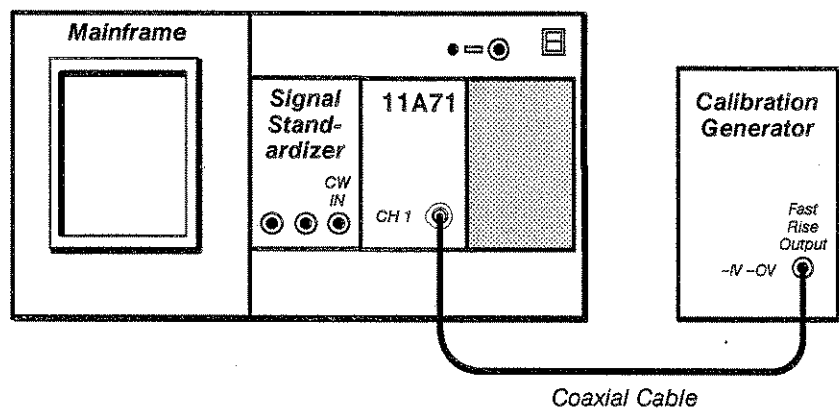

Setup to Examine/Adjust Low-Frequency Transient Response: Standard Procedure

Procedure to Examine/Adjust Low-Frequency Transient Response:
 Standard Procedure

- Step 1: Remove the top cover of the mainframe. Then, **Initialize** the mainframe's settings, and perform the following settings in the order listed:

Mainframe

- STORE/RECALL major menu Select **Delete Waveform** label (if highlighted) then **All Waveforms**, to clear memory
- Def Wfm icon Select
- Vertical Description pop-up menu L (left)
- TRIGGER major menu **Source Desc**
- Main Trigger Source Description** pop-up menu L (left)
- Main Size** 1 ms/div
- Main Pos** -1 ms

Signal standardizer

- Test Vert or Horiz + Step Resp
- Amplitude 8 div
- Position 1 div from top
- Rep Rate 100 Hz

Mainframe
Store Waveform Wfm 1
Signal standardizer
Rep Rate 1 kHz
Mainframe
Main Size 100 μ s/div
Store Waveform Wfm 1
Signal standardizer
Rep Rate 10 kHz
Mainframe
Main Size 10 μ s/div
Store Waveform Wfm 1
Remove Wfm L (left)
Center plug-in
CH 1 Display on/off on
Mainframe
Vert Size 100 mV/div
Vert Offset -400 mV
Calibration Generator
Function Fast Rise
Period 10 ms
Pulse Amplitude 8 div
Mainframe
Main Size 1 ms/div
Recall Waveform Stored 1

- Step 2: *Examine* the dim waveform (as compared to the bright waveform) for a flat top, within the limits of +1% peak and -0.5% peak.



DO NOT attempt to adjust the compensation if it is within the stated limits. Proceed to Step 4.

- Step 3: *Adjust* compensation adjustments, R410 and R411 on the A1 Main board, for a flat top on the dim waveform as compared to the bright waveform. See Figure 2-3 for adjustment locations.
- Step 4: Set the calibration generator Period to 1 ms.
- Step 5: **Remove Wfm; Stored 1.**
- Step 6: Set **Main Size** to 100 μ s/div.
- Step 7: **Recall Waveform; Stored 2.**
- Step 8: *Examine* the waveform for minimum long-term spiking and rolloff (flat top), within the limits of +1% peak and -0.5% peak.



DO NOT attempt to adjust the compensation if it is within the stated limits. Proceed to Step 10.

- Step 9: *Adjust* compensation adjustment, R311 and R312 on the A1 Main board, for optimum square-wave flat top. See Figure 2-3 for adjustment locations.
- Step 10: Set the calibration generator Period to 0.1 ms.
- Step 11: **Remove Wfm; Stored 2.**
- Step 12: Set the **Main Size** to 10 μ s/div.
- Step 13: **Recall Waveform; Stored 3.**
- Step 14: *Examine* the waveform for minimum long-term spiking and rolloff (flat top), within 1% peak and -0.5% peak.



DO NOT attempt to adjust the compensation if it is within the stated limits. Proceed to Step 16.

- Step 15: *Adjust* compensation adjustment, R310, R510, and C412 on the A1 Main board, for optimum square-wave flat top. See Figure 2-3 for adjustment locations.
- Step 16: Reinstall the top cover of the mainframe.

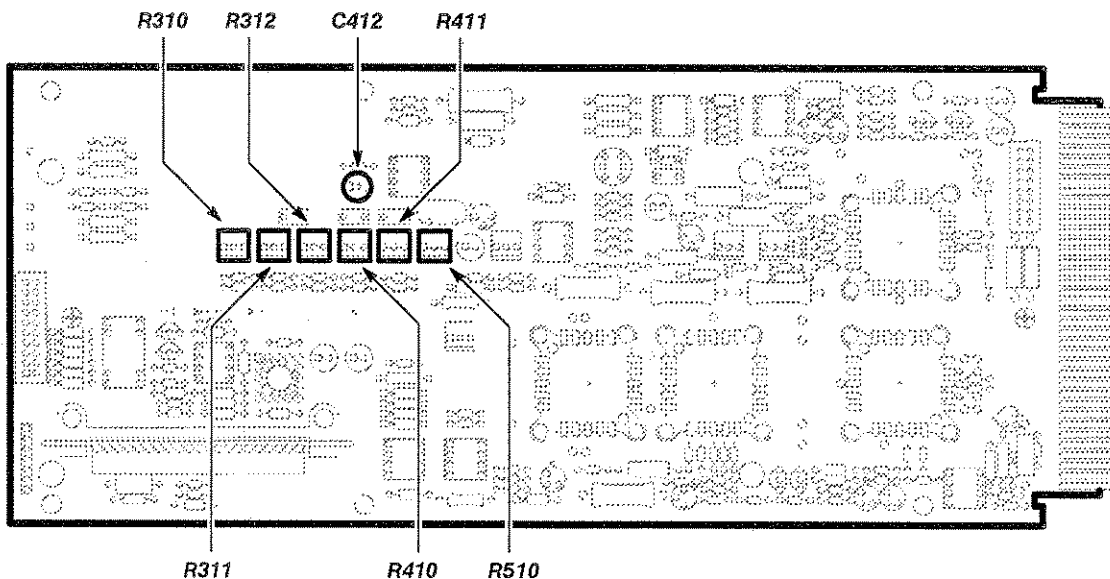

Figure 2-3 -- A1 Main Board Low-Frequency Response Adjustment Locations

Part 5b
Low-Frequency
Transient Response:
 Alternate Procedure

Compensation networks are adjusted to optimize the transient response. This procedure is used when an 11400-Series mainframe is not available. Performance is assured only for the particular amplifier and mainframe combination examined and adjusted in this procedure.

Measurement Limit

The waveform should have a flat top (minimum long-term spiking and rolloff).

Setup to Examine/Adjust Low-Frequency Transient Response:
 Alternate Procedure

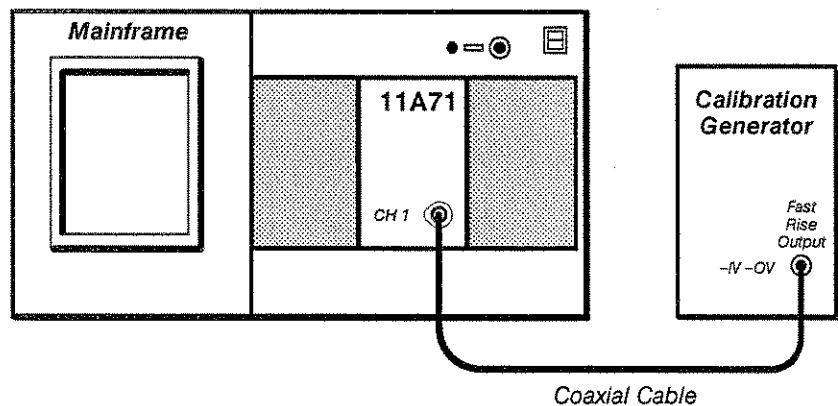

Setup to Examine/Adjust Low-Frequency Transient Response: Alternate Procedure

Procedure to Examine/Adjust Low-Frequency Transient Response:
 Alternate Procedure

- Step 1: Remove the top cover of the mainframe. Then, **Initialize** the mainframe's settings, and perform the following settings in the order listed:

Center plug-in

CH 1 Display on/off on

Mainframe

HORIZONTAL SIZE 1 ms/div

VERTICAL SIZE 100 mV/div

VERTICAL OFFSET -400 mV

Calibration generator

Function Fast Rise

Period 10 ms

Pulse Amplitude 8 div

- Step 2: *Examine* the waveform for a flat top.



DO NOT attempt to adjust the compensation if the waveform already appears to be appropriate. Proceed to Step 4.

- Step 3: *Adjust* compensation adjustments, R410 and R411 on the A1 Main board, for a flat top on the waveform. See Figure 2-3 for adjustment locations.
- Step 4: Set the calibration generator Period to 1 ms.
- Step 5: Set **Main Size** to 100 μ s/div.
- Step 6: *Examine* the waveform for minimum long-term spiking and rolloff (flat top).



DO NOT attempt to adjust the compensation if the waveform already appears to be appropriate. Proceed to Step 8.

- Step 7: *Adjust* compensation adjustment, R311 and R312 on the A1 Main board, for optimum square-wave flat top. See Figure 2-3 for adjustment locations.
- Step 8: Set the calibration generator period to 0.1 ms.
- Step 9: Set the **Main Size** to 10 μ s/div.
- Step 10: *Examine* the waveform for minimum long-term spiking and rolloff (flat top).



DO NOT attempt to adjust the compensation if the waveform already appears to be appropriate. Proceed to Part 6, Bandwidth.

- Step 11: *Adjust* compensation adjustment, R310, R510, and C412 on the A1 Main board, for optimum square-wave flat top. See Figure 2-3 for adjustment locations.
- Step 12: Reinstall the top cover of the mainframe.
- Step 13: Move the amplifier from the Center to the Left plug-in compartment.

Part 6 Bandwidth

First, amplitude is measured at the specification frequencies using the signal standardizer, to characterize the mainframe.

Then, the displayed amplitude is checked at the specification frequencies to determine the amplifier's contribution to the bandwidth.

Specified performance of the amplifier in all mainframes is ensured only if the amplifier is tested in an 11402 or 11403 mainframe. If the amplifier is tested in a mainframe of lower bandwidth, then specified performance is ensured only in mainframes of equal or lower bandwidth.

Specifications (Performance Verification)

Refer to Tables 2-3 and 2-4 for the bandwidth specifications. Use either Table 2-3 or 2-4 depending on the type of mainframe you are using.

Specifications (Functional Test)

A peak-peak measurement ≥ 848 mV.

Setup to Examine Mainframe Bandwidth

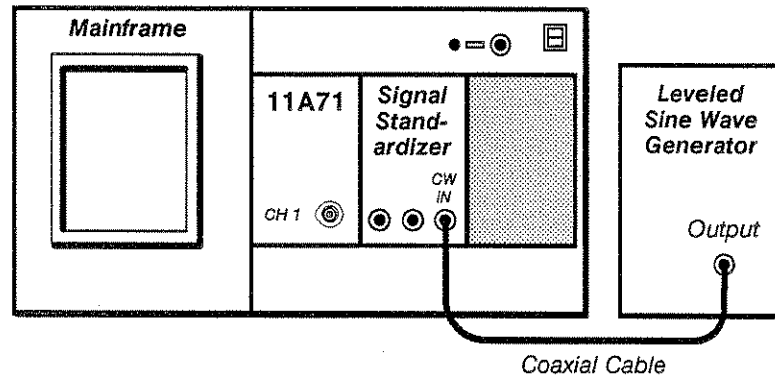

Setup to Examine Mainframe Bandwidth

Procedure to Examine Mainframe Bandwidth

- Step 1: First **Initialize** the mainframe's settings, then perform the following settings in the order listed:

Mainframe

Waveform C (center)
 Trigger Source C (center)
Main Size or HORIZONTAL SIZE 10 μ s/div
 Left plug-in not used in this step

Signal Standardizer

Test Vert or Horiz Freq Resp

Leveled sine wave generator

Frequency reference

The reference frequency must be between 50 kHz and 6 MHz.

- Step 2: Set the leveled sine wave generator output amplitude so that the Signal Standardizer CW Leveled light is on. Ensure that the light remains on throughout the following steps.
- Step 3: Set the signal standardizer Position and Amplitude for a 6-division display amplitude, centered on the screen.
- Step 4: Set the leveled sine wave generator frequency to each Test Frequency in column (1) of Table 2-3 or Table 2-4, and record the Displayed Amplitude in column (2) on a copy of Table 2-3 or Table 2-4. This data is used in the Procedure to Check Amplifier Bandwidth for calculating the amplifier bandwidth.
- Step 5: Set the mainframe ON/STANDBY switch to STANDBY.
- Step 6: Remove the signal standardizer from the Center plug-in compartment. Remove the amplifier from the Left plug-in compartment and reinstall it in the Center plug-in compartment.

Setup to Check Amplifier Bandwidth: Performance Verification Procedure

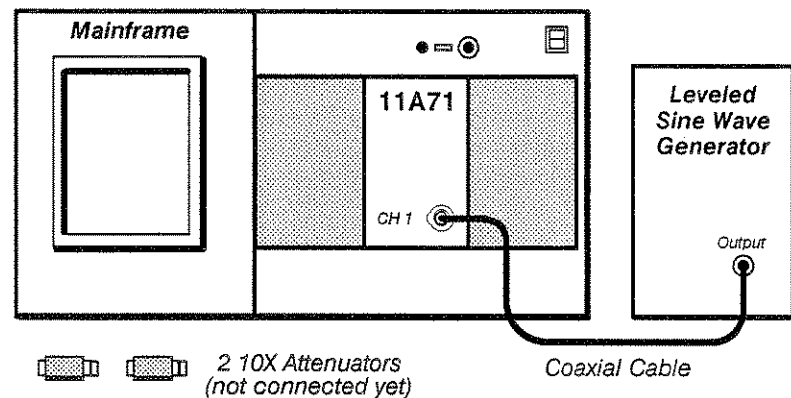

Setup to Check Amplifier Bandwidth: Performance Verification Procedure

Procedure to Check Amplifier Bandwidth: Performance Verification Procedure

- Step 1: First **Initialize** the mainframe's settings, then perform the following settings in the order listed:

Center plug-in

CH1 Display on/off on
Mainframe

Main Size or HORIZONTAL SIZE 10 μ s/div

Impedance 50 Ω

Leveled sine wave generator

Amplitude 4 V p-p

Frequency Ref

If the leveled sine wave generator has a remote leveling head, then you must connect it to the amplifier input connector without additional coaxial cables.

The reference frequency must be between 50 kHz and 6 MHz.

Perform this procedure for each Vertical Size listed in column (3) of Table 2-3 or Table 2-4.

If the leveled sine wave generator is not equipped with internal attenuators, then use the 10X attenuators at the amplifier input when setting amplitude.

To measure the amplitude, either count the divisions, or use the ΔV cursors.

- Step 2: Set the leveled sine wave generator amplitude as shown in the Reference Amplitude column (4).
- Step 3: Set the leveled sine wave generator frequency as shown in the Frequency column (1).
- Step 4: Record the Displayed Amplitude in column (5).

- Step 5: Check that the amplifier amplitude, computed by dividing column (5) by column (2), is at least the value shown in column (6).
- Step 6: Set the leveled sine wave generator to the reference frequency.

Table 2-3 – 11A71 Amplifier Bandwidth in the 11402 or 11403 Mainframe

(1) Test Frequency MHz	(2)	(3) Vertical Size	(4) Reference Amplitude: div	(5) Displayed Amplitude: div	(6) Amplifier only Calculated Amplitude: col (5) ÷ col (2)
	Mainframe with Standardizer Displayed Amplitude: div				
1000	_____	1 V/div	4	_____	_____ ≥0.575
1000	_____	500 mV/div	6	_____	_____ ≥0.863
1000	_____	50 mV/div	6	_____	_____ ≥0.863
1000	_____	20 mV/div	6	_____	_____ ≥0.863
1000	_____	10 mV/div	6	_____	_____ ≥0.863
500	_____	10 mV/div	6	_____	_____ ≥0.925

Table 2-4 – 11A71 Amplifier Bandwidth in the 11401 or 11300-Series Mainframes

(1) Test Frequency MHz	(2)	(3) Vertical Size	(4) Reference Amplitude: div	(5) Displayed Amplitude: div	(6) Amplifier only Calculated Amplitude: col (5) ÷ col (2)
	Mainframe with Standardizer Displayed Amplitude: div				
500	_____	1 V/div	4	_____	_____ ≥0.617
500	_____	500 mV/div	6	_____	_____ ≥0.925
500	_____	50 mV/div	6	_____	_____ ≥0.925
500	_____	20 mV/div	6	_____	_____ ≥0.925
500	_____	10 mV/div	6	_____	_____ ≥0.925

Part 6 Bandwidth

- Step 5: Check that the amplifier amplitude, computed by dividing column (5) by column (2), is at least the value shown in column (6).
- Step 6: Set the leveled sine wave generator to the reference frequency.

Table 2-3 – 11A71 Amplifier Bandwidth in the 11402 or 11403 Mainframe

(1) Test Frequency MHz	(2) Mainframe with Standardizer	(3) Vertical Size	(4) Mainframe with Amplifier		(6) Amplifier only
	Displayed Amplitude: div		Reference Amplitude: div	Displayed Amplitude: div	Calculated Amplitude: col (5) ÷ col (2)
1000	5.32	1 V/div	4	5.32	1.00 ≥ 0.575
1000	5.32	500 mV/div	6	5.32	1.00 ≥ 0.863
1000	5.32	50 mV/div	6	4.27	0.80 ≥ 0.863
1000	5.32	20 mV/div	6	4.27	0.80 ≥ 0.863
1000	5.32	10 mV/div	6	4.27	0.80 ≥ 0.863
500	5.74	10 mV/div	6	5.32	0.93 ≥ 0.925

Table 2-4 – 11A71 Amplifier Bandwidth in the 11401 or 11300-Series Mainframes

(1) Test Frequency MHz	(2) Mainframe with Standardizer	(3) Vertical Size	(4) Mainframe with Amplifier		(6) Amplifier only
	Displayed Amplitude: div		Reference Amplitude: div	Displayed Amplitude: div	Calculated Amplitude: col (5) ÷ col (2)
500	—	1 V/div	4	—	— ≥ 0.617
500	—	500 mV/div	6	—	— ≥ 0.925
500	—	50 mV/div	6	—	— ≥ 0.925
500	—	—	6	—	— ≥ 0.925
500	—	—	6	—	— ≥ 0.925

check on
% figs. in
col. 6 ?
Called 503-627-3086
1-15-90
Roger Enswood - will
research + get back

- Step 5: Check that the amplifier amplitude, computed by dividing column (5) by column (2), is at least the value shown in column (6).
- Step 6: Set the leveled sine wave generator to the reference frequency.

Table 2-3 – 11A71 Amplifier Bandwidth in the 11402 or 11403 Mainframe

(1) Test Frequency MHz	(2)	(3) Vertical Size	(4) Reference Amplitude: div	(5) Displayed Amplitude: div	(6) Amplifier only Calculated Amplitude: col (5) ÷ col (2)
	Mainframe with Standardizer Displayed Amplitude: div				
1000	4.0 @ REF.	1 V/div	4	3.34	83.5% ≥0.575
1000	3.004V @ REF	500 mV/div	6	2.42	80.6% ≥0.863
1000	2.004V @ REF	50 mV/div	6	2.37	79.9% ≥0.863
1000	12.0 mV	20 mV/div	6	9.50	79.2% ≥0.863
1000	60 mV	10 mV/div	6	4.6	77.5% ≥0.863
500	60 mV	10 mV/div	6	53.6	89.3% ≥0.925

Table 2-4 – 11A71 Amplifier Bandwidth in the 11401 or 11300-Series Mainframes

(1) Test Frequency MHz	(2)	(3) Vertical Size	(4) Reference Amplitude: div	(5) Displayed Amplitude: div	(6) Amplifier only Calculated Amplitude: col (5) ÷ col (2)
	Mainframe with Standardizer Displayed Amplitude: div				
500	_____	1 V/div	4	_____	_____ ≥0.617
500	_____	500 mV/div	6	_____	_____ ≥0.925
500	_____	50 mV/div	6	_____	_____ ≥0.925
500	_____	20 mV/div	6	_____	_____ ≥0.925
500	_____	10 mV/div	6	_____	_____ ≥0.925

A.
10K
500V

- Step 5: Check that the amplifier amplitude, computed by dividing column (5) by column (2), is at least the value shown in column (6).
- Step 6: Set the leveled sine wave generator to the reference frequency.

Table 2-3 – 11A71 Amplifier Bandwidth in the 11402 or 11403 Mainframe

(1) Test Frequency MHz	(2)	(3) Vertical Size	(4) Reference Amplitude: div	(5) Displayed Amplitude: div	(6) Amplifier only Calculated Amplitude: col (5) ÷ col (2)
	Mainframe with Standardizer Displayed Amplitude: div				
1000	_____	1 V/div	4	_____	_____ ≥0.575
1000	_____	500 mV/div	6	_____	_____ ≥0.863
1000	_____	50 mV/div	6	_____	_____ ≥0.863
1000	_____	20 mV/div	6	_____	_____ ≥0.863
1000	_____	10 mV/div	6	_____	_____ ≥0.863
500	_____	10 mV/div	6	_____	_____ ≥0.925

Table 2-4 – 11A71 Amplifier Bandwidth in the 11401 or 11300-Series Mainframes

(1) Test Frequency MHz	(2)	(3) Vertical Size	(4) Reference Amplitude: div	(5) Displayed Amplitude: div	(6) Amplifier only Calculated Amplitude: col (5) ÷ col (2)
	Mainframe with Standardizer Displayed Amplitude: div				
500	_____	1 V/div	4	_____	_____ ≥0.617
500	_____	500 mV/div	6	_____	_____ ≥0.925
500	_____	50 mV/div	6	_____	_____ ≥0.925
500	_____	20 mV/div	6	_____	_____ ≥0.925
500	_____	10 mV/div	6	_____	_____ ≥0.925

Part 6 Bandwidth

- Step 5: Check that the amplifier amplitude, computed by dividing column (5) by column (2), is at least the value shown in column (6).
- Step 6: Set the leveled sine wave generator to the reference frequency.

Table 2-3 – 11A71 Amplifier Bandwidth in the 11402 or 11403 Mainframe

(1) Test Frequency MHz	(2)	(3) Vertical Size	(4)	(5) Displayed Amplitude: div	(6) Amplifier only Calculated Amplitude: col (5) ÷ col (2)
	Mainframe with Standardizer Displayed Amplitude: div		Mainframe with Amplifier Reference Amplitude: div		
1000	_____	1 V/div	4	_____	_____ ≥0.575
1000	_____	500 mV/div	6	_____	_____ ≥0.863
1000	_____	50 mV/div	6	_____	_____ ≥0.863
1000	_____	20 mV/div	6	_____	_____ ≥0.863
1000	_____	10 mV/div	6	_____	_____ ≥0.863
500	_____	10 mV/div	6	_____	_____ ≥0.925

Table 2-4 – 11A71 Amplifier Bandwidth in the 11401 or 11300-Series Mainframes

(1) Test Frequency MHz	(2)	(3) Vertical Size	(4)	(5) Displayed Amplitude: div	(6) Amplifier only Calculated Amplitude: col (5) ÷ col (2)
	Mainframe with Standardizer Displayed Amplitude: div		Mainframe with Amplifier Reference Amplitude: div		
500	_____	1 V/div	4	_____	_____ ≥0.617
500	_____	500 mV/div	6	_____	_____ ≥0.925
500	_____	50 mV/div	6	_____	_____ ≥0.925
500	_____	20 mV/div	6	_____	_____ ≥0.925
500	_____	10 mV/div	6	_____	_____ ≥0.925

Part 6 Bandwidth

- Step 5: Check that the amplifier amplitude, computed by dividing column (5) by column (2), is at least the value shown in column (6).
- Step 6: Set the leveled sine wave generator to the reference frequency.

Table 2-3 – 11A71 Amplifier Bandwidth in the 11402 or 11403 Mainframe

(1) Test Frequency MHz	(2)	(3) Vertical Size	(4) Reference Amplitude: div	(5) Displayed Amplitude: div	(6) Amplifier only Calculated Amplitude: col (5) ÷ col (2)
	Mainframe with Standardizer Displayed Amplitude: div				
1000	_____	1 V/div	4	_____	_____ ≥0.575
1000	_____	500 mV/div	6	_____	_____ ≥0.863
1000	_____	50 mV/div	6	_____	_____ ≥0.863
1000	_____	20 mV/div	6	_____	_____ ≥0.863
1000	_____	10 mV/div	6	_____	_____ ≥0.863
500	_____	10 mV/div	6	_____	_____ ≥0.925

Table 2-4 – 11A71 Amplifier Bandwidth in the 11401 or 11300-Series Mainframes

(1) Test Frequency MHz	(2)	(3) Vertical Size	(4) Reference Amplitude: div	(5) Displayed Amplitude: div	(6) Amplifier only Calculated Amplitude: col (5) ÷ col (2)
	Mainframe with Standardizer Displayed Amplitude: div				
500	_____	1 V/div	4	_____	_____ ≥0.617
500	_____	500 mV/div	6	_____	_____ ≥0.925
500	_____	50 mV/div	6	_____	_____ ≥0.925
500	_____	20 mV/div	6	_____	_____ ≥0.925
500	_____	10 mV/div	6	_____	_____ ≥0.925

10X
1000

Part 6 Bandwidth

- Step 5: Check that the amplifier amplitude, computed by dividing column (5) by column (2), is at least the value shown in column (6).
- Step 6: Set the leveled sine wave generator to the reference frequency.

Table 2-3 – 11A71 Amplifier Bandwidth in the 11402 or 11403 Mainframe

(1) Test Frequency MHz	(2)	(3) Vertical Size	(4)	(5)	(6)
	Mainframe with Standardizer Displayed Amplitude: div		Mainframe with Amplifier Reference Amplitude: div		Amplifier only Calculated Amplitude: col (5) ÷ col (2)
1000	_____	1 V/div	4	_____	_____ ≥0.575
1000	_____	500 mV/div	6	_____	_____ ≥0.863
1000	_____	50 mV/div	6	_____	_____ ≥0.863
1000	_____	20 mV/div	6	_____	_____ ≥0.863
1000	_____	10 mV/div	6	_____	_____ ≥0.863
500	_____	10 mV/div	6	_____	_____ ≥0.925

Table 2-4 – 11A71 Amplifier Bandwidth in the 11401 or 11300-Series Mainframes

(1) Test Frequency MHz	(2)	(3) Vertical Size	(4)	(5)	(6)
	Mainframe with Standardizer Displayed Amplitude: div		Mainframe with Amplifier Reference Amplitude: div		Amplifier only Calculated Amplitude: col (5) ÷ col (2)
500	_____	1 V/div	4	_____	_____ ≥0.617
500	_____	500 mV/div	6	_____	_____ ≥0.925
500	_____	50 mV/div	6	_____	_____ ≥0.925
500	_____	20 mV/div	6	_____	_____ ≥0.925
500	_____	10 mV/div	6	_____	_____ ≥0.925

set.
10X
slow

- Step 5: Check that the amplifier amplitude, computed by dividing column (5) by column (2), is at least the value shown in column (6).
- Step 6: Set the leveled sine wave generator to the reference frequency.

Table 2-3 – 11A71 Amplifier Bandwidth in the 11402 or 11403 Mainframe

(1)	(2)	(3)	(4)	(5)	(6)
Test Frequency MHz	Mainframe with Standardizer	Mainframe with Amplifier			Amplifier only
	Displayed Amplitude: div	Vertical Size	Reference Amplitude: div	Displayed Amplitude: div	Calculated Amplitude: col (5) ÷ col (2)
1000	_____	1 V/div	4	_____	_____ ≥0.575
1000	_____	500 mV/div	6	_____	_____ ≥0.863
1000	_____	50 mV/div	6	_____	_____ ≥0.863
1000	_____	20 mV/div	6	_____	_____ ≥0.863
1000	_____	10 mV/div	6	_____	_____ ≥0.863
500	_____	10 mV/div	6	_____	_____ ≥0.925

Table 2-4 – 11A71 Amplifier Bandwidth in the 11401 or 11300-Series Mainframes

(1)	(2)	(3)	(4)	(5)	(6)
Test Frequency MHz	Mainframe with Standardizer	Mainframe with Amplifier			Amplifier only
	Displayed Amplitude: div	Vertical Size	Reference Amplitude: div	Displayed Amplitude: div	Calculated Amplitude: col (5) ÷ col (2)
500	_____	1 V/div	4	_____	_____ ≥0.617
500	_____	500 mV/div	6	_____	_____ ≥0.925
500	_____	50 mV/div	6	_____	_____ ≥0.925
500	_____	20 mV/div	6	_____	_____ ≥0.925
500	_____	10 mV/div	6	_____	_____ ≥0.925

A.
10X
150W

- Step 5: Check that the amplifier amplitude, computed by dividing column (5) by column (2), is at least the value shown in column (6).
- Step 6: Set the leveled sine wave generator to the reference frequency.

Table 2-3 – 11A71 Amplifier Bandwidth in the 11402 or 11403 Mainframe

(1) Test Frequency MHz	(2)	(3)	(4)	(5)	(6)
	Mainframe with Standardizer Displayed Amplitude: div	Mainframe with Amplifier Vertical Size	Mainframe with Amplifier Reference Amplitude: div	Mainframe with Amplifier Displayed Amplitude: div	Amplifier only Calculated Amplitude: col (5) ÷ col (2)
1000	_____	1 V/div	4	_____	_____ ≥0.575
1000	_____	500 mV/div	6	_____	_____ ≥0.863
1000	_____	50 mV/div	6	_____	_____ ≥0.863
1000	_____	20 mV/div	6	_____	_____ ≥0.863
1000	_____	10 mV/div	6	_____	_____ ≥0.863
500	_____	10 mV/div	6	_____	_____ ≥0.925

Table 2-4 – 11A71 Amplifier Bandwidth in the 11401 or 11300-Series Mainframes

(1) Test Frequency MHz	(2)	(3)	(4)	(5)	(6)
	Mainframe with Standardizer Displayed Amplitude: div	Mainframe with Amplifier Vertical Size	Mainframe with Amplifier Reference Amplitude: div	Mainframe with Amplifier Displayed Amplitude: div	Amplifier only Calculated Amplitude: col (5) ÷ col (2)
500	_____	1 V/div	4	_____	_____ ≥0.617
500	_____	500 mV/div	6	_____	_____ ≥0.925
500	_____	50 mV/div	6	_____	_____ ≥0.925
500	_____	20 mV/div	6	_____	_____ ≥0.925
500	_____	10 mV/div	6	_____	_____ ≥0.925

est.
10X
atten

Setup to Check Amplifier Bandwidth: Functional Test Procedure

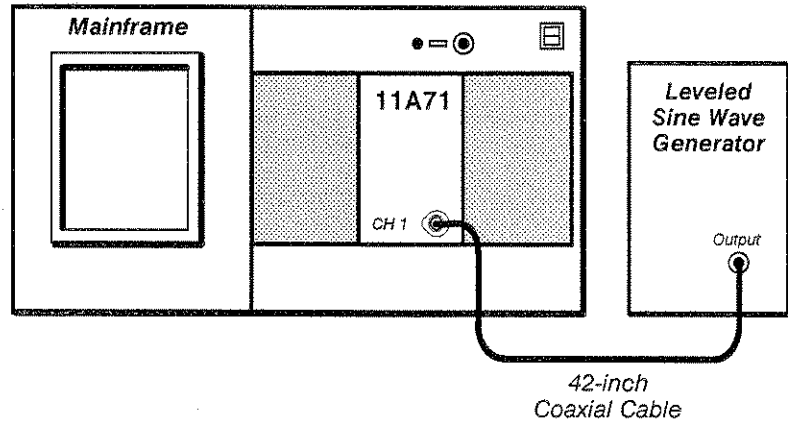

Setup to Check Amplifier Bandwidth: Functional Test Procedure

Procedure to Check Amplifier Bandwidth: Functional Test Procedure

- Step 1: First **Initialize** the mainframe's settings, then perform the following settings in the order listed:

Amplifier

CH 1 Display on/off on
 Leveled sine wave generator

Frequency Ref (6 MHz)

Mainframe

Vert Size or VERTICAL SIZE 200 mV/div

Main Size or HORIZONTAL SIZE 100 ns/div

- Step 2: Select the **Peak-Peak** measurement, if available, or the **Cursors** to measure the peak-to-peak amplitude of the waveform.
- Step 3: Set the leveled sine wave generator for 1.2 V peak-to-peak.
- Step 4: Set the leveled sine wave generator Frequency control to the maximum bandwidth frequency specified for the mainframe-amplifier combination. This limit is displayed as **BW Limit** (WAVEFORM button) on the 11400-Series mainframe or **HF Limit** (VERTICAL SIZE button) on the 11300-Series mainframe.
- Step 5: Set the **Main Size** or HORIZONTAL SIZE to display several cycles of the waveform.
- Step 6: Check that the measurement is at least 848 mV (70.7% of Step 3).
- Step 7: Set the CH 1 display on/off button to off.
- Step 8: Move the coaxial cable to the CH 2 input and set its display on/off to on.

cursor

*CH 1 981 mV
 81.7%
 CH 2 226 mV
 83.9%*

*CH 3 226 mV
 83.9%*

Part 7 Overload

This part shows the setup and lists the procedure to check overload.

Specification

Coupling changes to off.

Setup to Check Overload

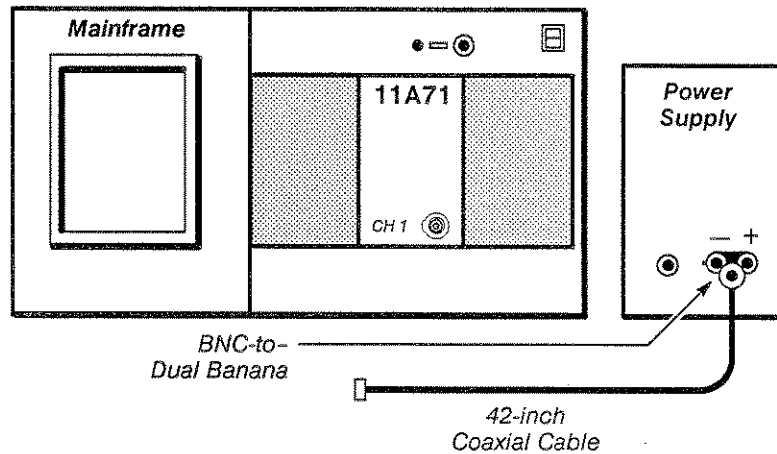

Setup to Check Overload

Procedure to Check Overload

- Step 1: First **Initialize** the mainframe's settings, then perform the following settings in the order listed:

Mainframe	no setting changes
Amplifier	
CH 1 Display on/off	on
Power supply	
Volts	20 V
Current Limit	400 mA

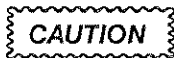

In the following steps, **IMMEDIATELY** disconnect the cable at the input if the impedance does not change within 3 seconds.

- Step 2: Connect the power supply to the CH 1 input using the 42-inch coaxial cable.
- Step 3: Check that the **Coupling** changes to **Off**.
- Step 4: Disconnect the power supply at the input.
- Step 5: Set the **Coupling** back to **DC**.
- Step 6: Set the Ch 2 display on/off to on.

Part 8 Input Resistance

This part shows the setup and lists the procedure to check input resistance.

Specification

Impedance resistance is $50\ \Omega$ within $\pm 1\ \Omega$.

Setup to Check Input Resistance

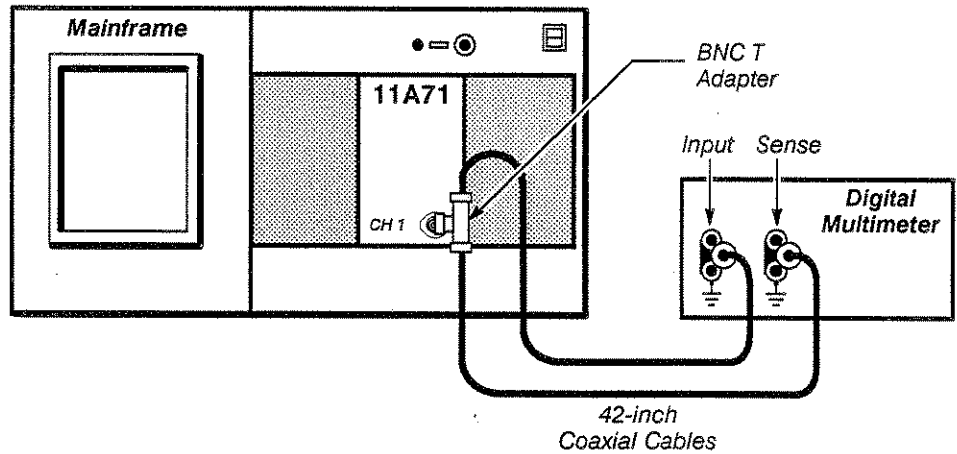

Setup to Check Input Resistance

Procedure to Check Input Resistance

- Step 1: First **Initialize** the mainframe's settings, then perform the following settings in the order listed:

Mainframe no setting changes
Amplifier
 CH 1 Display on/off on
Digital multimeter (DMM)
 Resistance mode 4-Wire

- Step 2: Check that input resistance is $50\ \Omega$ within $\pm 1\ \Omega$.

Part 9 Vertical Accuracy

This part shows the setup and lists the procedure to check vertical accuracy.

Specifications

The specifications for this part are as follows:

- DC balance so that trace is within ± 0.2 divisions of center from 10 mV through 1 V.
- Peak-Peak measurement of 5 V \pm 95 mV for the 11300-Series and 5 V \pm 65 mV for the 11400-Series.

Setup to Check Vertical Accuracy

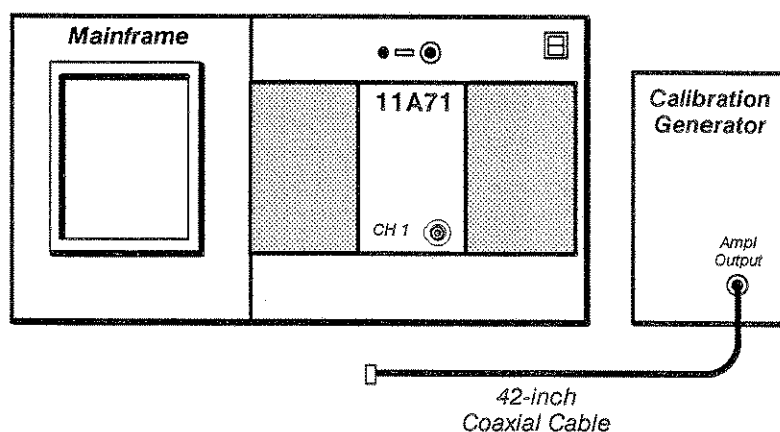

Setup to Check Vertical Accuracy

Procedure to Check Vertical Accuracy

- Step 1: First **Initialize** the mainframe's settings, then perform the following settings in the order listed:

Amplifier

CH 1 Display on/off on

Calibration generator

Mode Std Ampl

Amplitude Output 10 V

Mainframe

Main Size or HORIZONTAL SIZE 100 μ s/div

Average N (if available) **On**

Check DC Balance—by performing Step 2.

- Step 2: *Check* the Vertical Size for each position from 10 mV through 1 V and observe that the trace stays within ± 0.2 divisions of center.

Check Gain—by performing Steps 3 through 7.

- Step 3: Connect the calibration generator output to the CH 1 input using the 42-inch coaxial cable.
- Step 4: Set the **Vert Size** or VERTICAL SIZE to 1 V/div. (Note that the PG 506 outputs 10 V but only 5 V p-p are seen at the amplifier input due to the loading by the 50 Ω input impedance.
- Step 5: Set the **Vert Offset** or VERTICAL OFFSET to +2.5 V.
- Step 6: Select the **Peak-Peak** measurement, if available, or the vertical amplitude **Cursors** and measure the peak-to-peak amplitude of the waveform.
- Step 7: Check that the measurement is 5 V, plus or minus
95 mV for the 11300-Series mainframe, or
65 mV for the 11400-Series mainframe.

Part 10 AC Coupling

This part shows the setup and lists the procedure to check AC coupling.

Specifications

The specifications for this part are as follows:

- Bottom of square wave is near the center graticule line.
- The waveform is vertically centered on the screen (see Fig. 2-4).

Setup to Check AC Coupling

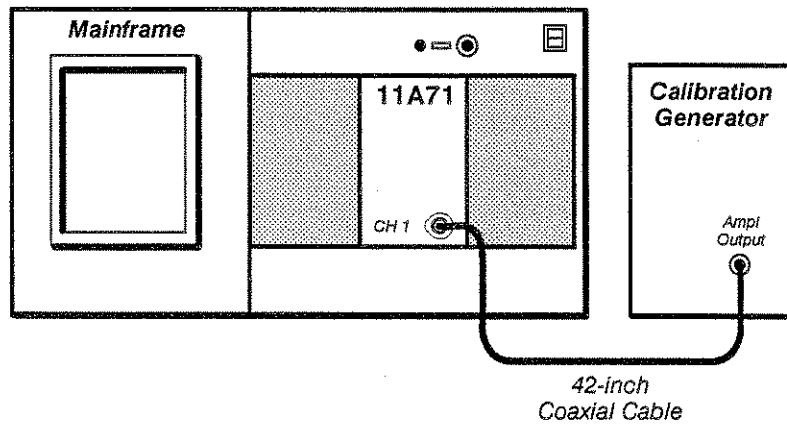

Setup to Check AC Coupling

Procedure to Check AC Coupling

- Step 1: First **Initialize** the mainframe's settings, then perform the following settings in the order listed:

Amplifier

CH 1 Display on/off on

Calibration generator

Mode Std Ampl

Amplitude 5 V

Mainframe

Vert Size or VERTICAL SIZE 500 mV/div

Main Size or HORIZONTAL SIZE 100 μ s/div

- Step 2: *Check* that the bottom of the square wave is near the center graticule line.
- Step 3: Select AC Coupling for the CH 1 input.
- Step 4: *Check* that the waveform is vertically centered on the screen and that it resembles the waveform shown in Figure 2-4.

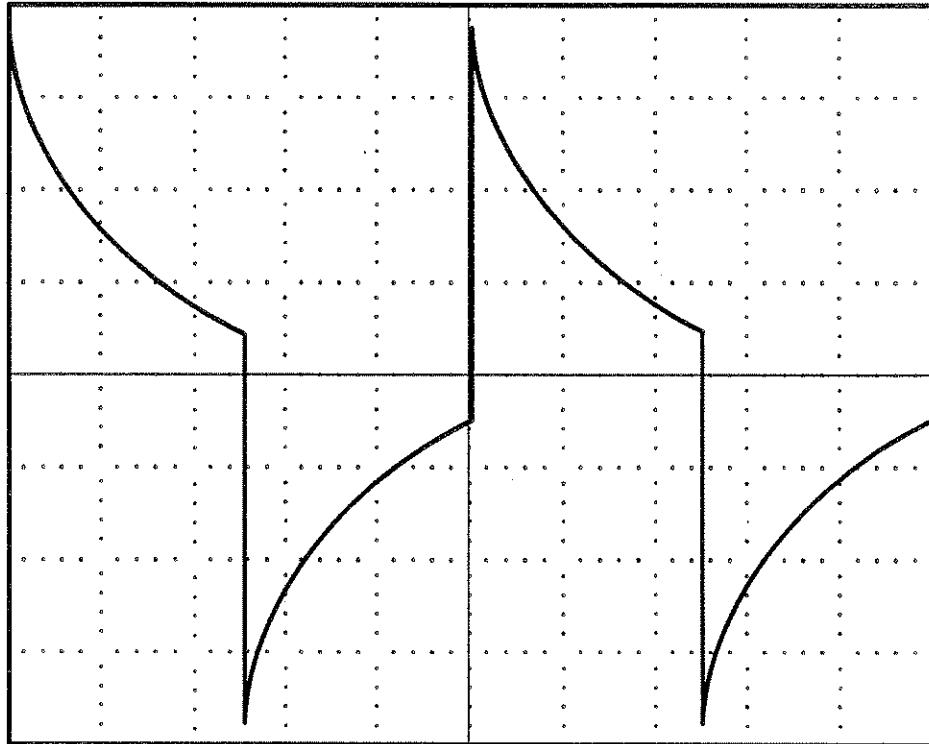

Figure 2-4 – Waveform with AC Coupling Selected

Part 11 DC Balance

The position of the displayed trace with no input signal applied is examined.

The purpose of this procedure is to confirm that DC balance can be accomplished accurately. This procedure does not test for drift over time or temperature. Therefore, the specifications are more stringent than the specifications in the *11A71 User's Reference Supplement* and this procedure must be performed immediately after Enhanced Accuracy calibration.

Specification

Balance within ± 0.2 division.

Setup to Check DC Balance

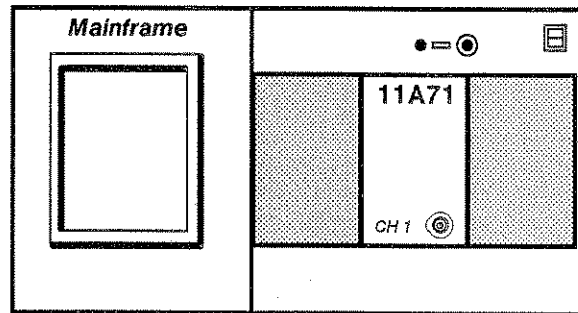

Setup to Check DC Balance

Procedure to Check DC Balance

- Step 1: First **Initialize** the mainframe's settings then perform the following settings in the order listed.

Center plug-in

CH 1 Display on/off on
Mainframe no setting changes

- Step 2: *Check* that the displayed trace position is at the center graticule line, within ± 0.2 division for each Vertical Size setting.

If you are using the 11300-Series mainframe, use **Vertical Cursors** to help measure the trace position.

If you are using the 11400-Series mainframe, set **Average N** to **On** and use **Mean (whole zone)** in the **Measurement** pop-up menu to help measure the trace position.

Part 12a
ΔV DC Accuracy:
 11400-Series
 Mainframe Procedure

The system ΔV DC Accuracy is checked using a precision digital multimeter and power supply. The system must be in Enhanced Accuracy mode during this procedure.

The purpose of this procedure is to confirm that the amplifier can be accurately calibrated. This procedure does not test for mainframe calibration voltage reference accuracy or long term stability. Therefore, the mainframe is characterized and tests must be performed immediately after an Enhanced Accuracy calibration. Also, the amplifier specifications are more stringent than those in the *11A71 User's Reference Supplement*.

Specification

ΔV DC Accuracy within ±0.8%.

Setup to Characterize the 11400-Series Mainframe

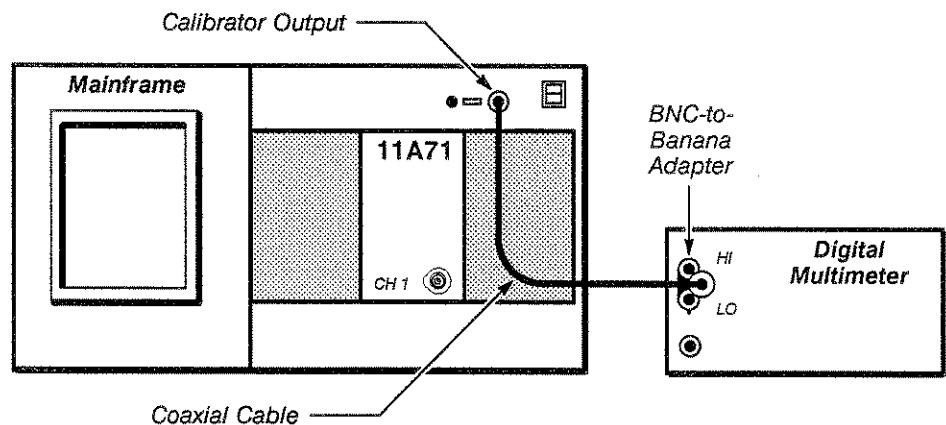

Setup to Characterize the 11400-Series Mainframe

Procedure to Characterize the 11400-Series Mainframe

Step 1: Perform the following settings:

- Center plug-in no setting changes
- Mainframe
 - UTILITY major menu **Extended Diagnostics**
 - Subsystem** **Digitizer**
 - Block** **Points Acq**
 - Area** **Cal Refs**
 - Routine** **FP -10.000 V**
 - Run**
- Digital multimeter (DMM)
 - Mode DC
 - Range Auto

- Step 2: Record the DMM absolute value.
- Step 3: Press **Exit**.
- Step 4: Press **FP + 9.9951 V**.
- Step 5: Press **Run**.
- Step 6: Record the DMM reading.
- Step 7: Press **Exit**.
- Step 8: Press **Exit Diagnostics**.
- Step 9: Add the DMM absolute values of the readings obtained in Steps 2 and 6. Divide the result by 19.9951 V to obtain the mainframe's calibration voltage reference characterization factor (which is used in the Procedure to Check the Amplifier ΔV DC Accuracy).

Setup to Check the Amplifier ΔV DC Accuracy

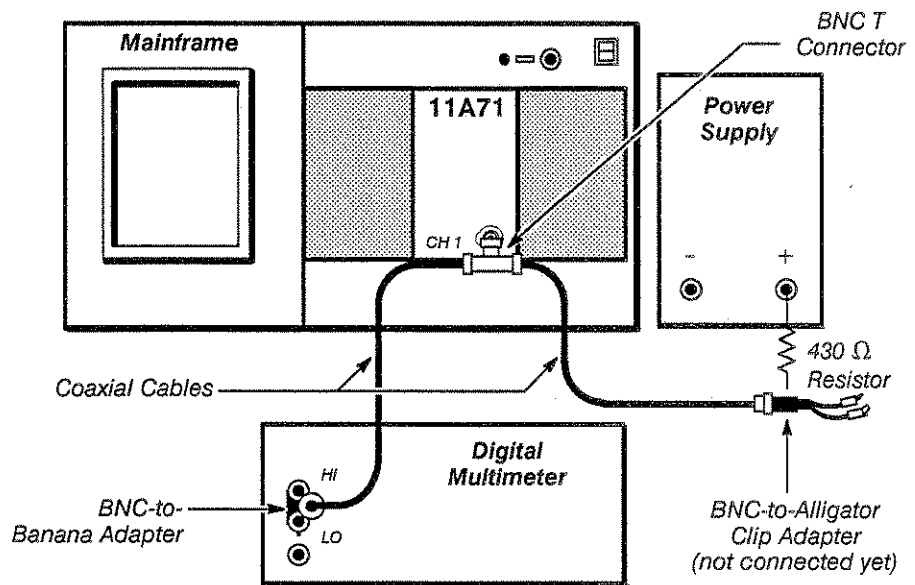

Setup to Check the Amplifier ΔV DC Accuracy

Procedure to Check the Amplifier ΔV DC Accuracy

- Step 1: First **Initialize** the mainframe's settings, then perform the following settings in the order listed.
 - Center plug-in
 - CH 1 Display on/off on
 - Mainframe no setting changes
 - Power supply
 - Output on

Digital multimeter (DMM)

Mode DC
Range Auto

If the environment is electrically noisy, then connect a capacitor (at least 0.1 μF) across the input terminals of the DMM.

Press the Enhanced Accuracy button twice. Immediately after self-calibration has completed and passed, perform this procedure.

It is helpful if you use a pocket calculator to do the calculations required for evaluating the data in this part. If your DMM is equipped with a comparison or relative reference feature, use this feature for the readings and calculation required in Steps 3 and 5.

When connecting the alligator clips, connect one clip directly to the power supply's negative terminal and the other clip to the 430 Ω resistor (not the power supply's positive terminal).

- Step 2: Set **Average N to On**, select **Mean (whole zone)** in the MEASURE major menu, and set **Compare to On**.
- Step 3: Connect the alligator clips to the power supply and set the voltage so that the trace is within ± 0.2 division of the first graticule line above the bottom of the screen. Read the DMM and record the absolute value (that is, ignore the polarity).
- Step 4: Select **Save Current Meas Value as References** in the **Compare and Reference** pop-up menu of the MEASURE major menu.
- Step 5: Connect the alligator clips to the power supply and set the voltage so that the trace is within ± 0.2 division of the first graticule line below the top of the screen. Read the DMM and add the absolute value (that is, ignore the polarity) to the reading obtained in Step 3.
- Step 6: Read the Δ **Mean** value in the MEASURE major menu.
- Step 7: Divide the sum obtained in Step 5 by the Δ readout obtained in Step 6. Then, divide this result by the mainframe characterization factor (obtained in Step 9 of the Procedure to Characterize 11400-Series Mainframe).
- Step 8: *Check* that the result obtained in Step 7 is ≥ 0.992 but ≤ 1.008 .

- Step 9: Repeat Steps 3 through 8 for the vertical size settings listed below. When testing with small voltages, it may help to install attenuators in series between the BNC-to-alligator clip adapter and the coaxial cable so that you can set the voltages with better resolution. You can also use a DC voltage calibrator to achieve better resolution (when testing with small voltages).

1 V/div
0.5 V/div
0.2 V/div
0.1 V/div
50 mV/div
49.8 mV/div
23 mV/div
20 mV/div
10 mV/div

Part 12b
ΔV DC Accuracy:
 11300-Series
 Mainframe Procedure

The system ΔV DC Accuracy is checked using a precision digital multimeter and power supply. The system must be in Enhanced Accuracy mode during this procedure.

The purpose of this procedure is to confirm that the amplifier can be accurately calibrated. This procedure does not test for mainframe calibration voltage reference accuracy or long term stability. Therefore, the mainframe is characterized and tests must be performed immediately after an Enhanced Accuracy calibration. Also, the amplifier specifications are more stringent than those in the *11A71 User's Reference Supplement*.

Specification

ΔV DC Accuracy within ±1.5%.

Setup to Characterize the 11300-Series Mainframe

Note: After entering *Extended Test*, verify that your mainframe's firmware is Version V2.4 or higher. If your mainframe's firmware version is lower than V2.4, then you cannot perform this procedure.

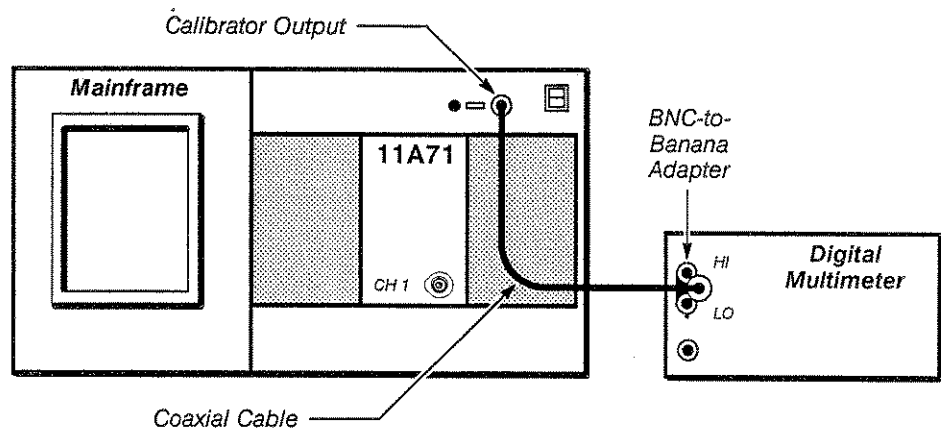

Setup to Characterize the 11300-Series Mainframe

Procedure to Characterize the 11300-Series Mainframe

Step 1: Perform the following settings:

- Center plug-in no setting changes
- Mainframe
 - UTILITY major menu Ext Test
 - Run Front Panel
 - Block FP Calibrator
 - Area -9.9988 V
 - Routine cnt()
 - Loop cnt()
 - Run

Digital multimeter (DMM)

Mode DC
 Range Auto

- Step 2: Record the DMM reading.
- Step 3: Select **Run**.
- Step 4: Select **Routine** and set to **+9.9939V**.
- Step 5: Select **Run**.
- Step 6: Record the DMM reading.
- Step 7: Select **Run**.
- Step 8: Press the **UTILITY** button.
- Step 9: Add the absolute values of the DMM readings obtained in Steps 2 and 6. Divide the result by 19.9927 to obtain the mainframe's calibration voltage reference characterization factor (which is used in the Procedure to Check the Amplifier ΔV DC Accuracy).

Setup to Check the Amplifier ΔV DC Accuracy

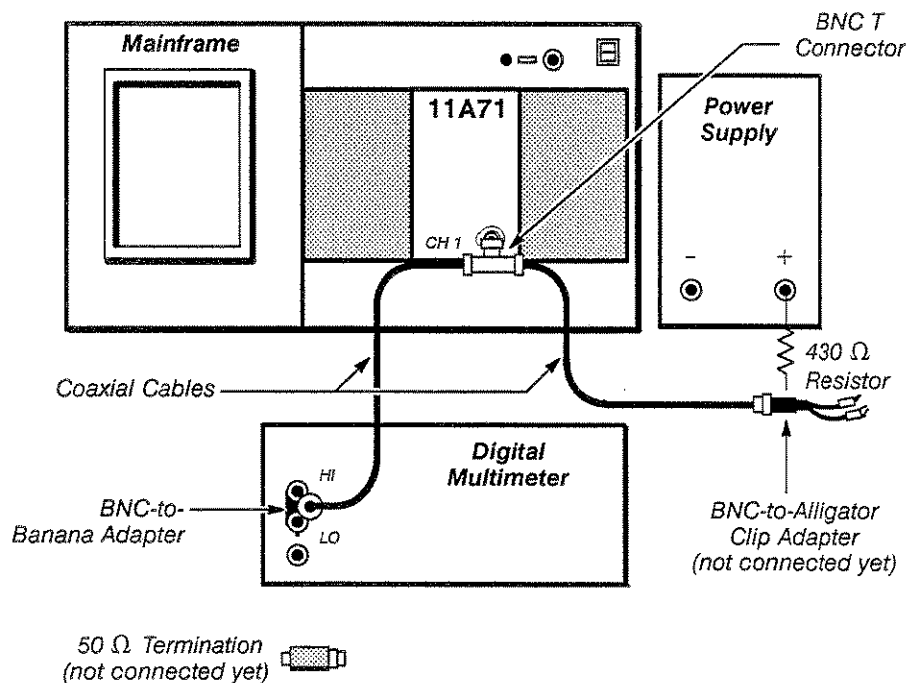

Setup to Check the Amplifier ΔV DC Accuracy

Procedure to Check the Amplifier ΔV DC Accuracy

- Step 1: First **Initialize** the mainframe's settings, then perform the following settings in the order listed.

Center plug-in

CH 1 Display on/off on
Mainframe no setting changes

Power supply

Output on

Digital multimeter (DMM)

Mode DC

Range Auto

If the environment is electrically noisy, then connect a capacitor (at least 0.1 μ F) across the input terminals of the DMM.

Press the Enhanced Accuracy button twice. Immediately after self-calibration has completed and passed, perform this procedure.

It is helpful if you use a pocket calculator to do the calculations required for evaluating the data in this part. If your DMM is equipped with a comparison or relative reference feature, use this feature for the readings and calculation required in Steps 3 and 5.

When connecting the alligator clips, connect one clip to the power supply's negative terminal directly and the other clip to the 430 Ω resistor (not the power supply's positive terminal).

- Step 2: Select **Vertical Cursors**.
- Step 3: Connect the alligator clips to the power supply and set the voltage so that the trace is within ± 0.2 divisions of the first graticule line above the bottom of the screen. Read the DMM and record the absolute value (that is, ignore the polarity).
- Step 4: Set the **Vert Ref** cursor on the trace using the left function control knob with FINE resolution.
- Step 5: Connect the alligator clips to the power supply and set the voltage so that the trace is within ± 0.2 divisions of the first graticule line below the top of the screen. Read the DMM and add the absolute value to the reading obtained in Step 3.
- Step 6: Set the Δ **Vert** cursor on the trace using the right function control knob with FINE resolution. Read the Δ **Vert** readout.
- Step 7: Divide the sum obtained in Step 5 by the Δ readout obtained in Step 6. Then divide this result by the mainframe characterization factor obtained in Step 9 of the Procedure to Characterize 11300-Series Mainframe.
- Step 8: Check that the result obtained in Step 7 is ≥ 0.985 but ≤ 1.015 .

- Step 9: Repeat Steps 3 through 8 for the vertical size settings listed below. When testing with small voltages, it may help to install attenuators in series between the BNC-to-alligator clip adapter and the coaxial cable so that you can set the voltages with better resolution. You can also use a DC voltage calibrator to achieve better resolution (when testing with small voltages).

1 V/div
0.5 V/div
0.2 V/div
0.1 V/div
50 mV/div
49.8 mV/div
23 mV/div
20 mV/div
10 mV/div

Part 13 DC Offset Accuracy

The system DC Offset is checked using a precision digital multimeter and a power supply.

The purpose of this procedure is to confirm that the amplifier can be accurately calibrated. This procedure does not test for mainframe calibration voltage reference accuracy or long term stability. Therefore, the mainframe is characterized and tests must be performed immediately after an Enhanced Accuracy calibration. Also, the amplifier specifications are more stringent than those in the *11A71 User's Reference Supplement*.

Specifications

Refer to Table 2-5.

Setup to Characterize the 11400-Series Mainframe

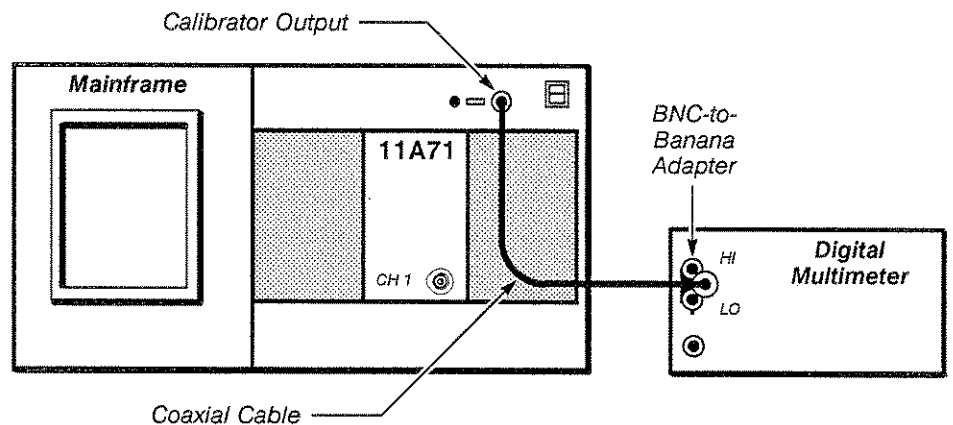

Setup to Characterize the 11400-Series Mainframe

Procedure to Characterize the 11400-Series Mainframe

- Step 1: Perform the following settings:

Center plug-in	no setting changes
Mainframe	
UTILITY major menu	Extended Diagnostic
Block	Points Acq
Area	Cal Refs
Routine	FP -10.000 V
Run	
Digital multimeter (DMM)	
Mode	DC
Range	Auto

- Step 2: Record the DMM absolute value.

- Step 3: Press **Exit**.
- Step 4: Press **FP + 9.9951 V**.
- Step 5: Press **Run**.
- Step 6: Record the DMM reading.
- Step 7: Press **Exit**.
- Step 8: Press **Exit Diagnostics**.
- Step 9: Add the absolute values of the DMM readings obtained in Steps 2 and 6. Divide the result by 19.9951 V to obtain the mainframe's calibration voltage reference characterization factor (which is used in the Procedure to Check the Amplifier DC Offset Accuracy).

Setup to Characterize the 11300-Series Mainframe

Note: After entering Extended Test, verify that your mainframe's firmware is Version V2.4 or higher. If your mainframe's firmware version is lower than V2.4, then you cannot perform this procedure.

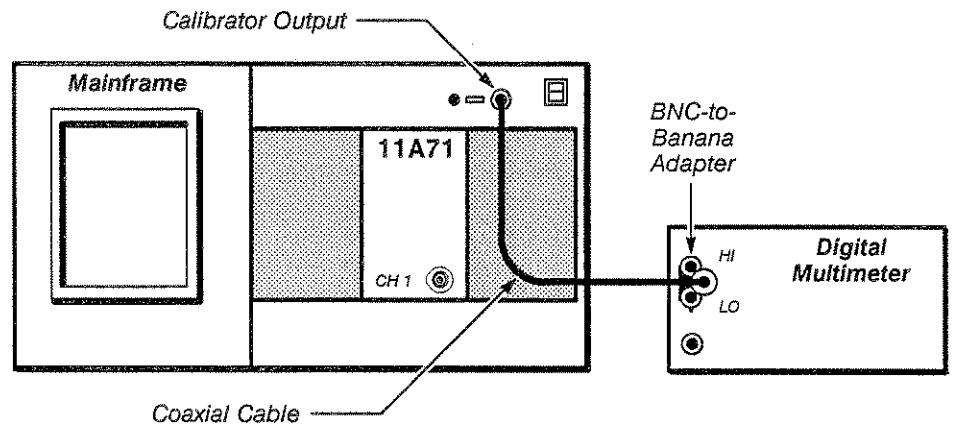

Setup to Characterize the 11300-Series Mainframe

Procedure to Characterize the 11300-Series Mainframe

- Step 1: Perform the following settings:
 - Center plug-in no setting changes
 - Mainframe
 - UTILITY major menu Ext Test
 - Block Front Panel
 - Area FP Calibrator
 - Routine -9.9988 V
 - Loop cnt()
 - Run

Digital Multimeter (DMM) no setting changes

- Step 2: Record the DMM reading.
- Step 3: Select **Run**.
- Step 4: Select **Routine** and set to **+9.9939**.
- Step 5: Select **Run**.
- Step 6: Record the DMM reading.
- Step 7: Select **Run**.
- Step 8: Press the **UTILITY** button.
- Step 9: Add the absolute values of the DMM readings obtained in Steps 2 and 6. Divide the result by 19.9927 to obtain the mainframe's calibration voltage reference characterization factor (which is used in the Procedure to Check the Amplifier DC Offset Accuracy).

Setup to Check the Amplifier ΔV DC Offset Accuracy

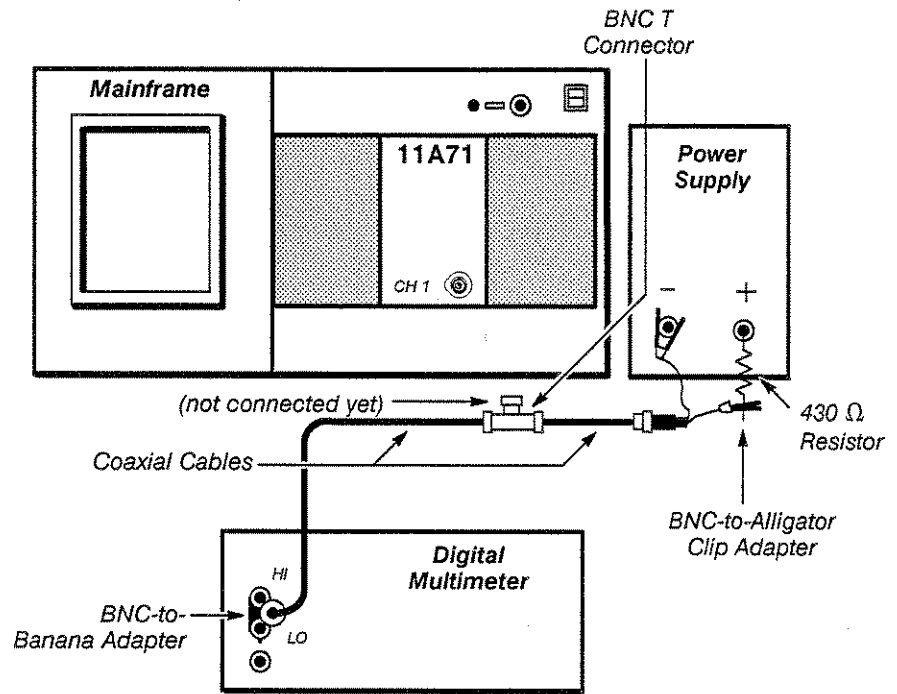

Setup to Check the Amplifier ΔV DC Accuracy

Procedure to Check the Amplifier ΔV DC Offset Accuracy

- Step 1: First **Initialize** the mainframe's settings, then perform the following settings in the order listed:

Center plug-in

CH 1 Display on/off on

Mainframe no setting changes

Power supply

Voltage On

Digital multimeter (DMM)

Mode DC

Range Auto

If the environment is electrically noisy, then connect a capacitor (at least 0.1 μF) across the input terminals of the DMM.

Press the Enhanced Accuracy button twice. Immediately after self-calibration has completed and passed, perform this procedure.

When connecting the alligator clips, connect one clip directly to the power supply's negative terminal and the other clip to the 430 Ω resistor (not the power supply's positive terminal).

- Step 2: Note the position of the displayed trace (it should be near the center of the graticule).

If you are using the 11300-Series mainframe, use **Vertical Cursors** to help measure and set the trace position.

If you are using the 11400-Series mainframe, set **Average N** to **On** and use **Mean (whole zone)** in the MEASURE major menu to help measure and set the trace position.

- Step 3: Connect the BNC T Connector to the CH 1 input connector, with the DMM connected.
- Step 4: Set the **Vert Offset** or VERTICAL OFFSET to **4 V**. Set the power supply voltage so that the displayed trace returns to the position noted in Step 2. Divide the DMM reading by the mainframe characterization factor (obtained in the Procedure to Characterize the Mainframe) and subtract the Vertical Offset.
- Step 5: *Check* that the result obtained in Step 4 is less than the Error Limit shown in Table 2-5.
- Step 6: Disconnect the BNC T connector at the CH 1 input connector and set **Vert Offset** or VERTICAL OFFSET to **0**.
- Step 7: Repeat Steps 2 through 6 for each Vertical Size and Offset shown in Table 2-5. When testing with small voltages, it may help to install attenuators in series between the BNC-to-alligator clip adapter and the coaxial cable so that you can set the voltages with better resolution. You can also use a DC voltage calibrator to achieve better resolution (when testing with small voltages).

Table 2-5 – 11A71 Amplifier DC Offset Accuracy

Vertical Size	Vertical Offset	Error Limit (\pm Volts)
1 V/div	4 V	26.0 mV
500 mV/div	4 V	21.0 mV
200 mV/div	2 V	10.0 mV
100 mV/div	1 V	5.0 mV
50 mV/div	500 mV	2.5 mV
20 mV/div	200 mV	1.0 mV
10 mV/div	100 mV	0.50 mV
10 mV/div	50 mV	0.30 mV

Maintenance

This section contains information for performing preventive maintenance, corrective maintenance, and diagnostic troubleshooting on the 11A71 Amplifier. For more information on any equipment listed in this section refer to Table 2-2.

Preventive Maintenance

Preventive maintenance performed regularly can prevent or forestall amplifier breakdown and may improve amplifier reliability. The severity of the environment to which the amplifier is subjected determines the frequency of maintenance.

Amplifier Shield Removal

The side shields, top-and-bottom frames, and front panel reduce radiation of electromagnetic interference (EMI) from the amplifier. The side shields are held in place by grooves in the frame.

To remove a shield, pry it out with your fingers, beginning at the rear of the appropriate side. To install a shield, position it over the frame grooves, then press down with your fingers until the shield snaps into place. Pressure must be applied along the full length of the frames to secure the shield.

The amplifier will not slide into the mainframe if the side shields are not fully seated in the frames.

Cleaning

The amplifier should be cleaned as often as operating conditions require. Accumulation of dirt on components acts as an insulating blanket and prevents efficient heat dissipation, which can cause overheating and component breakdown. Dirt also provides an electrical conduction path that can result in amplifier failure.

The cabinet panels of the mainframe, in which the amplifier is installed, reduce the amount of dust reaching the interior of the amplifier. Keep the cabinet panels in place for safety and cooling.



CAUTION

Avoid the use of chemical cleaning agents which might damage the materials used in this amplifier. Use only Isopropyl alcohol or totally denatured ethyl alcohol. Before using any other type of cleaner, consult your Tektronix service center or representative.

Exterior—dust accumulated on the outside of the amplifier can be removed with a soft cloth or small brush. The brush is particularly useful for dislodging dirt in and around the side-shield ventilation holes and front-panel switches. Remove the side shields before cleaning them.

Interior — cleaning the interior of the amplifier should seldom be necessary. The best way to clean the interior is to blow off the accumulated dust with dry, low-velocity air (such as from a vacuum cleaner). Remove any dirt that remains with a soft brush or a cloth dampened with a mild solution of detergent and water. A cotton-tipped swab is useful for cleaning in narrow spaces, or for cleaning more delicate circuit components (refer to the topic Amplifier Hybrids, under Corrective Maintenance later in this section, for more information on Hypcon connectors).



Circuit boards and components must be dry before applying power to prevent damage from electrical shorts.

Visual Inspection

The amplifier should be inspected occasionally for loosely-seated or heat-damaged components. The corrective procedure for most visible defects is obvious. However, particular care must be taken if heat-damaged parts are found. Overheating usually indicates other problems in the instrument. Therefore, correcting the cause of overheating is important to prevent recurrence of the damage.

Periodic Electrical Adjustment

To ensure accurate measurements, check the electrical adjustment of this instrument after each 2,000 hours of operation, or every 24 months if used infrequently. Instructions are given in Section 2, Checks and Adjustments.

Corrective Maintenance

Corrective maintenance consists of Field Replaceable Unit (FRU) and FRU IC replacement. This section describes the techniques required to replace the FRUs in the amplifier.

Ordering Parts

When ordering replacement parts from Tektronix, Inc., include the following information:

- Amplifier type
- Amplifier serial number
- Description of the part (if electrical, include the circuit number)
- Tektronix part number

Static-Sensitive Device Classification

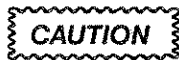

Static discharge can damage any semiconductor component in this amplifier.

This amplifier contains electrical components that are susceptible to damage from static discharge. Table 3-1 gives relative susceptibility of various classes of semiconductors. Static voltages of 1 kV to 30 kV are common in unprotected environments.

Observe the following precautions to avoid damage:

1. Minimize handling of static-sensitive components.
2. Transport and store static-sensitive components or assemblies in their original containers on a metal surface, or conductive foam. Label any package that contains static-sensitive assemblies or components.
3. Wear a wrist strap while handling these components to discharge the static voltage from your body. Servicing static-sensitive assemblies or components should be performed only at a static-free work station by qualified service personnel. The use of the static control mat and wrist strap is recommended.
4. Allow nothing capable of generating or holding a static charge on your work station surface.
5. Keep the component leads shorted together whenever possible.
6. Pick up components by the body, never by the leads.
7. Do not slide the components over any surface.
8. Avoid handling components in areas that have a floor or work-surface covering capable of generating a static charge.

Table 3-1 – Relative Susceptibility to Damage from Static Discharge

Semiconductor Classes	Relative Susceptibility Levels ¹
MOS or CMOS microcircuits, and discrete or linear microcircuits with MOS inputs (most sensitive)	1
ECL	2
Schottky signal diodes	3
Schottky TTL	4
High-frequency bipolar transistors	5
JFETs	6
Linear microcircuits	7
Low-power Schottky TTL	8
TTL (least sensitive)	9

¹Voltage equivalent for levels.

1 = 100 to 500 V

2 = 200 to 500 V

3 = 250 V

4 = 500 V

5 = 400 to 600 V

6 = 600 to 800 V

7 = 400 to 1000 V (est.)

8 = 900 V

9 = 1200 V

(The voltage equivalent is the voltage discharged from a 100 pF capacitor through a resistance of 100 Ω.)

Removing and Replacing FRUs

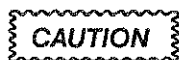

To avoid instrument damage, set the mainframe ON/STANDBY switch to STANDBY and remove the amplifier from the mainframe before removing or replacing FRUs.

See Figure 3-1 to determine the location of an FRU.

The exploded-view drawing in Section 5, Replaceable Parts, may also be useful in the removal/replacement procedures that follow.

Note that the side shields will have to be removed to gain access to most of the parts listed in the removal/replacement procedures that follow.



If the green light indicator remains lit when the STANDBY position is selected, then the switch has been left internally disabled after servicing the power supply. To enable the ON/STANDBY switch, refer to the Maintenance section of the mainframe Service Manual.

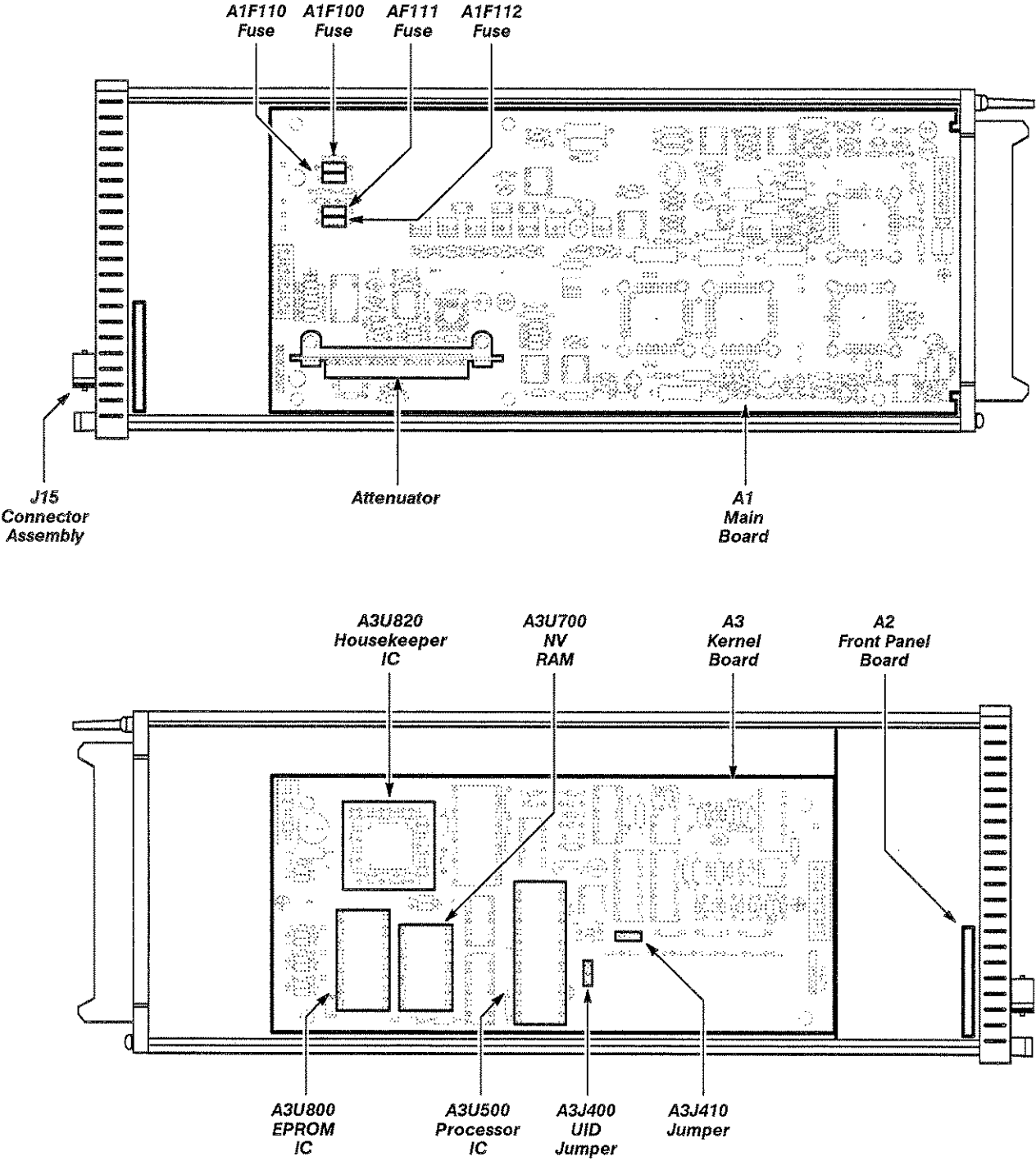

Figure 3-1 – Field Replaceable Units (FRU) Locator and A1 Main Board Securing Hardware

Removing/Replacing FRU ICs



Observe all the special precautions mentioned under the heading, "Static-Sensitive Device Classification," in this section.

Housekeeper Integrated Circuit ("Slam-Pack" ICs) – The Housekeeper IC (A1U600) is indexed to its socket by a beveled corner, as shown in Figure 3-2. The other corners are notched to fit the edges of the socket. The beveled corner aligns with a spring (small metal tab) at one corner of the socket.

Remove the Housekeeper IC as follows:

- Step 1: Unfasten the retaining clip by moving it across the tabs. It may help to push down slightly on the cover.
- Step 2: Remove the cover slowly to prevent the IC from falling out. Observe the index of the IC before removing it.
- Step 3: Remove the IC with tweezers.



Avoid touching the IC or the socket contacts with your fingers. Finger oils can lessen reliability.

Install the Housekeeper IC as follows:

- Step 1: Using tweezers, place the beveled corner of the replacement IC against the index spring.

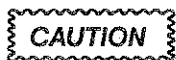

Do not damage the spring with the beveled corner. Shorting of the two corner contacts could result.

- Step 2: Arrange the other IC corners, with the tweezers, to fit evenly at the edges of the socket.
- Step 3: Set the cover flat on the IC with its end tabs properly aligned with the mating recesses in the socket. (The cover is not symmetrical.)
- Step 4: Push the cover down, keeping it flat on the IC, and slide into place. Hold the cover in place while moving the retaining clip over the tabs on the other end.

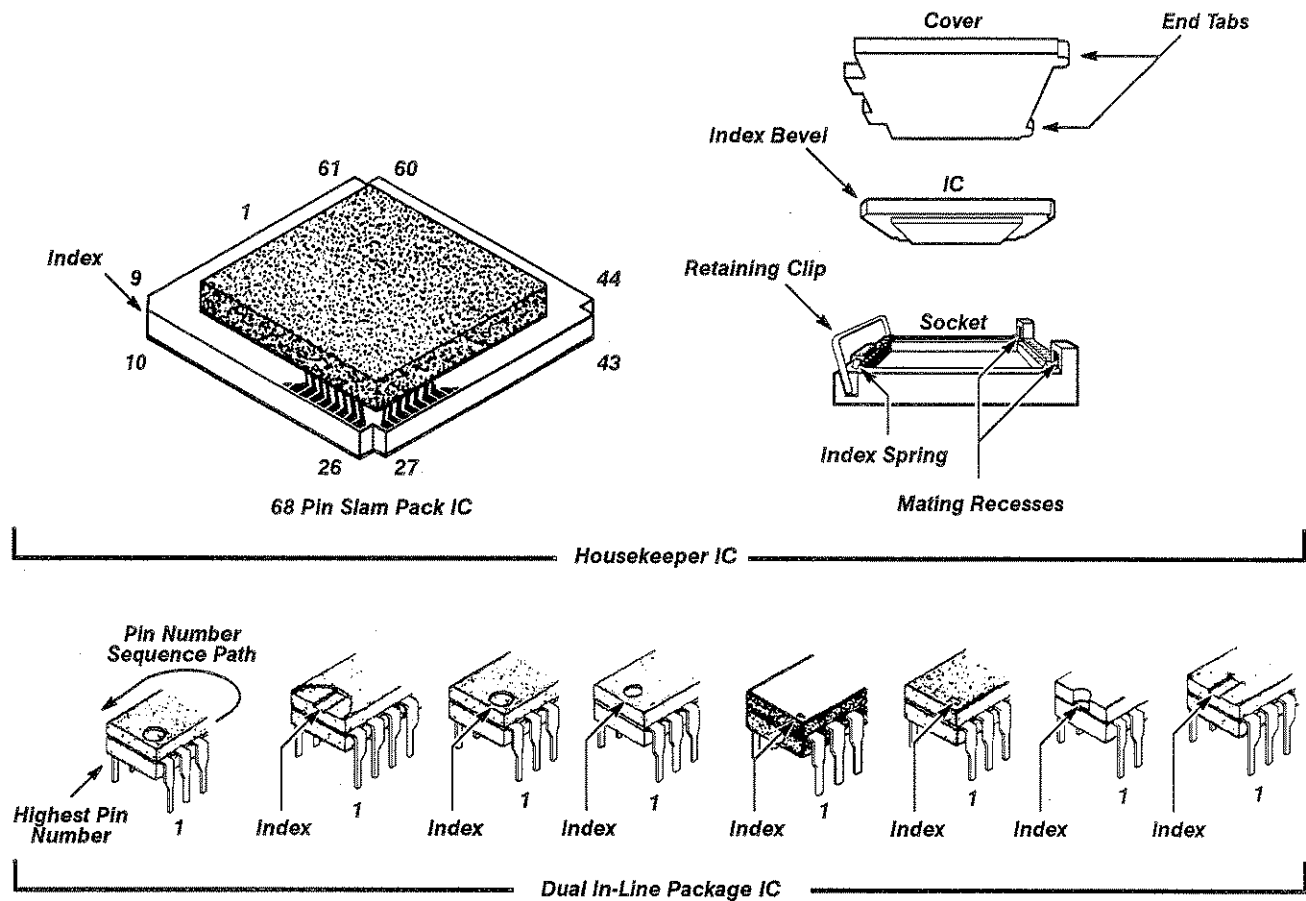

Figure 3-2 — Semiconductor Indexing Diagram

Amplifier Hybrids—Figure 3-3 shows an exploded view of the Hypcon (Hybrid-printed circuit connector) and gives disassembly and replacement instructions. When replacing the hybrid, do not touch the elastomer's gold-plated contacts with your fingers. Use a cleaner which will not lessen contact reliability. The Hypcon socket contacts are fragile. Use caution when removing and replacing a Hypcon to avoid damaging these contacts.

Before reinstallation, use a 4X (or greater) magnifying glass to examine the hybrid, elastomer, and the Hypcon contacts under light for dust, hair, lint, etc. If the etched circuit board surfaces require more cleaning, scrub with a soft rubber eraser. Blow or vacuum clean, while dusting the surface with a small clean brush.

If the hybrid and elastomer contact holder are contaminated, clean them by flushing or spraying with alcohol. **Do not scrub with a cotton-tipped swab or similar device.** (Cotton fibers may adhere to the contacts.) If the contact holder is excessively contaminated, replace it with a new one.

Tighten the mounting screws with two inch-pounds of torque (2.3 centimeter-kilograms) to secure the Hypcon to the circuit board.

Make sure that the elastomer is properly seated in the contact holder before remounting the assembly to the circuit board. Use care when mounting the whole assembly to the circuit board to prevent misalignment between the connector and board.



Because of close tolerances involved, special care must be taken to ensure correct index alignment of each Hypcon part during reassembly. (Fig. 3-3 shows the index locations.) Failure to do so can result in a cracked hybrid substrate.

Removing/Replacing the Hypcon Assemblies

When replacing the Hypcon (**Hybrid-printed circuit connector**) do not touch the elastomer's gold-plated contacts with your finger; instead, use a cleaner which will not lessen contact reliability. The Hypcon socket contacts are fragile. Therefore, refer to the cautions that follow, when removing and replacing a Hypcon, to avoid damaging these contacts.

Before remounting the Hypcon assembly, use a 4X (or greater) magnifying glass to examine the hybrid, elastomer, and the Hypcon contacts for dust, hair, lint, or other foreign matter. If the A1 Main board surfaces require more cleaning, then scrub the surface with a soft rubber eraser and blow on, or vacuum, the surface while dusting it with a small clean brush.

If the hybrid and elastomer contact holders are contaminated, then flush or spray the holders with alcohol.

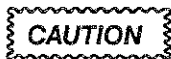

Do not scrub with a cotton-tipped swab or similar device, since cotton fibers may adhere to the contacts.)

If the contact holder is excessively contaminated, then replace the holder.

Next, tighten the mounting screws with two inch-pounds of torque (2.3 centimeter-kilograms) to secure the Hypcon to the board.

Ensure that the elastomer is properly seated in the contact holder before remounting the assembly to the A1 Main board. (That is, use care when mounting the assembly to the board to ensure that the proper alignment exists between the connector and A1 Main board.)

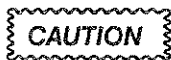

Special care must be taken to ensure correct index alignment of each Hypcon part during reassembly; since failure to do so can result in a cracked hybrid substrate.

See Figure 3-3 for indexing information.

Remove the Hypcon assembly as follows:

- Step 1: Notice the index on the A1 Main board (arrow) and the plastic frame (pointed tab).
- Step 2: Unscrew and remove the four Torx head screw/washer assemblies.

- Step 3: Lift the plastic frame from the A1 Main board.
- Step 4: Notice the index location of the hybrid, and remove the hybrid from A1 Main board with the tweezers.

Note: Step 5 describes the removal of the elastomer from the plastic frame. This step is unnecessary when replacing the hybrid only.

- Step 5: Notice the index location of the elastomer (contact holder). Grasp and lift the corner of the contact holder with the tweezers to remove the holder from the plastic frame. (Do not touch the gold-plated contacts with your fingers.)

Replace the Hypcon Assembly as follows:

- Step 1: Grasp a corner of the elastomer with the tweezers, and place the elastomer into the plastic frame.
- Step 2: Align the keyed corner of the elastomer with the keyed corner of plastic frame.
- Step 3: Tamp the elastomer into the plastic frame uniformly.

Note: Keeping the elastomer clean is very important. Small hairs and elastomer flash under the contacts, which are almost invisible to the naked eye, can prevent good electrical contact. Most apparent failures of the hybrid are actually due to contamination of the Hypcon. Therefore, do not touch the gold-plated contacts with your fingers.

- Step 4: Place the hybrid into the square hole in the A1 Main board. (The hybrid is keyed so that it will fit into the A1 Main board in only one orientation. When the back of the hybrid rests on the heat sink pedestal, the top of the hybrid should be flush with the top of the A1 Main board.)
- Step 5: Place the plastic frame, with the elastomer installed over the hybrid, so that the key (pointed tab) aligns with the corner arrow on the board.
- Step 6: Replace the four Torx head screw/washer assemblies, and apply two inch-pounds of torque, (2.3 cm-kg) to secure the connector assembly. Do not overtighten the assembly; since over-tightening the assembly will strip the microcircuit stiffener/heat sink mounting threads.

Exploded View of Hypcon Connector

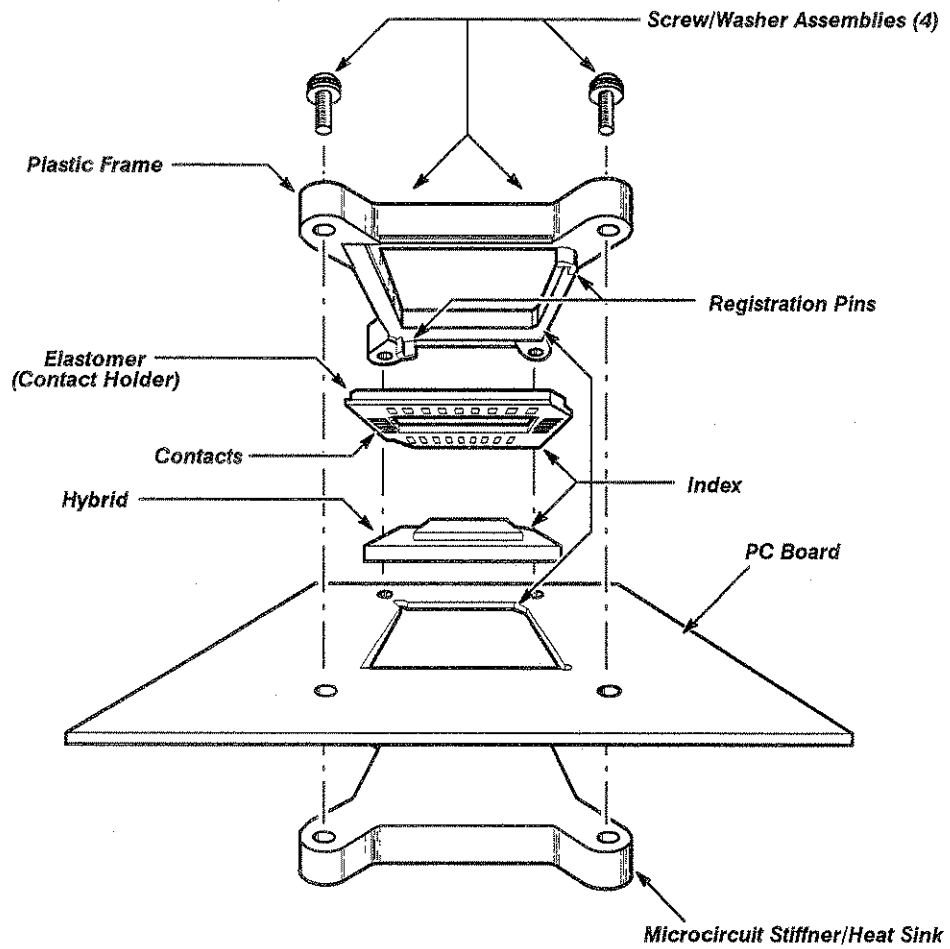

Cross Section View of Hypcon Connector

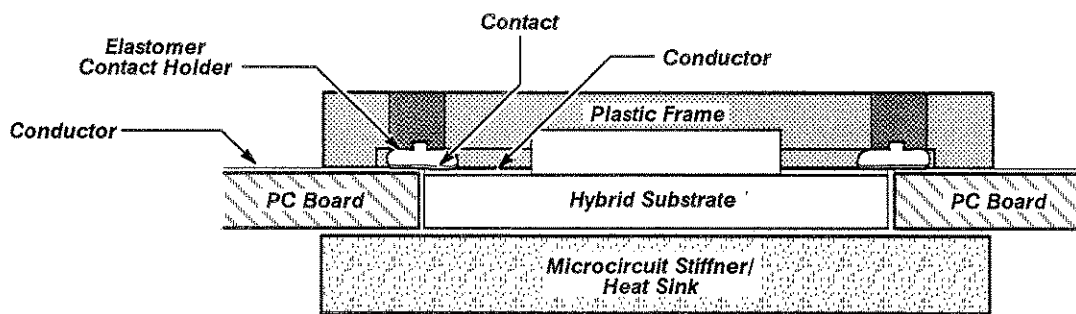

Figure 3-3 – Hypcon Assembly Removal and Replacement

DIP IC (Dual In-line Package Integrated Circuit)—If the RAM IC is soldered into the board, then consult a Tektronix service center for recommended removal procedures. Do not solder in the replacement IC. Instead, install a 24-pin socket and plug the RAM IC into the socket.

Remove the DIP IC as follows:

- Step 1: Use Insertion-Extraction Pliers (such as General Tool's Part Number U505BG, a 28-pin type) to remove the IC. An illustration of the pliers is shown in Figure 3-4.
- Step 2: Position the pliers around the outside of the IC. Squeeze the handles to grasp the IC and slowly pull it from the socket.

CAUTION

Avoid touching the removed IC pins or socket contacts with your fingers. Finger oils can lessen contact reliability.

Install the DIP IC as follows:

- Step 1: Grasp the IC with the Insertion-Extraction Pliers. Check that all the IC pins are straight and evenly spaced.
- Step 2: Do not use the IC label as an index. Look for the index on the IC body. Align the index slot with that of the A1U700 Processor IC underneath it. (Figure 3-2 gives an illustration of this indexing.)
- Step 3: Align the pins with their respective socket contacts and slowly seat the IC.

Note: *The Unit Identification (UID) is identical to the amplifier's serial number and is stored in NV RAM. If the EPROM is replaced it is necessary to enter a UID number. The amplifier's UID must be re-entered to generate and store the checksum. Failure to re-enter the UID will result in the "serial number" diagnostic failure during power-up self testing. Entry of the UID is described in this section, refer to Programming The Unit Identification.*

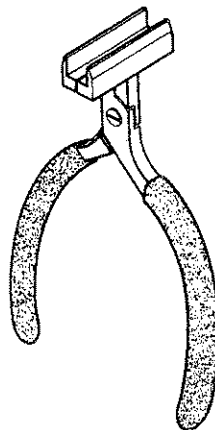

Figure 3-4 — IC Insertion-Extraction Pliers

Circuit Board and Attenuator FRU Removal

Remove the Front Panel as follows:

- Step 1: Unhook the return spring from the release bar, and set it aside.
- Step 2: Use a Torx T-8 screwdriver to remove the four screws that fasten the front subpanel to the top and bottom frames.
- Step 3: Pull the release bar as far out of the instrument as it will come, and leave it in that position.
- Step 4: Insert a slender, sharp-pointed tool, such as a scribe, between the front panel and the subpanel at the notch around the release bar. Gently separate the front panel from the subpanel. Use care to prevent bending the front panel.

Install the Front Panel as follows:

- Step 1: Check that the four screws that fasten the front subpanel to the top and bottom frames are removed.
- Step 2: Check that the release bar return spring is removed.
- Step 3: Set the amplifier on its side with the front panel facing you.
- Step 4: Pull the release bar as far out of the instrument as it will come, and leave it in that position.
- Step 5: Position the front panel so that the notch in the bottom fits over the release bar, then carefully insert the four front-panel tabs into the slots in the front subpanel. (You may need to pull the top and bottom frames away from the subpanel to allow the front-panel tabs to fit between the casting and the frames.)
- Step 6: Gently snap the edges of the front panel into place around the input connectors and the outer edges of the panel.
- Step 7: Use a Torx T-8 screwdriver to install the four screws that fasten the front subpanel to the top and bottom frames.
- Step 8: Install the release bar return spring. Orient the spring so that its loop fits over the frame hook correctly (flat against the frame section).

Remove and Install an A2 Front Panel Board as follows:

- Step 1: Remove the front panel.
- Step 2: Unplug the connector that provides electrical connection to the A3 Kernel board.
- Step 3: Use a Torx T-6 screwdriver to remove the two screws that fasten the A2 Front Panel board to the front subpanel, and remove the A2 Front Panel board.
- Step 4: To replace an A2 Front Panel board, follow the preceding steps in reverse order.

Remove and install the A3 Kernel Board as follows:

- Step 1: Unplug the A2 Front Panel board connector from the A3 Kernel board.
- Step 2: Remove the two gray A1 Main board connectors from the A3 Kernel board.
- Step 3: Use a Torx T-10 screwdriver to remove the four screws that fasten the A3 Kernel board to the A1 Main board.
- Step 4: To install, follow the preceding steps in reverse order.

Remove the Attenuator as follows:

- Step 1: Remove the A3 Kernel board.
- Step 2: Unplug the coaxial connectors from the input and output of the Attenuator.
- Step 3: Use a Torx T-10 screwdriver to remove the two screws that fasten the Attenuator to the A1 Main board (refer to Fig. 3-5).
- Step 4: Using care to keep it straight, unplug the Attenuator from the A1 Main board. Avoid disengaging one end of the Attenuator before disengaging the other end. Do not apply force to any subcomponents on the Attenuator.

Install the Attenuator as follows:

- Step 1: Set the amplifier on its side with the pushbutton down.
- Step 2: Align the Attenuator pins with the connector on the A1 Main board, and align the Attenuator frame with the holes in the A1 Main board.
- Step 3: Plug the Attenuator into its connector on the A1 Main board. Do not apply force to any subcomponents on the Attenuator.
- Step 4: Use a Torx T-10 screwdriver to install the two screws that fasten the Attenuator to the A1 Main board.
- Step 5: Plug the coaxial connectors into the input and output of the Attenuator (refer to Fig. 3-5). Care is necessary when engaging these connectors. For best results, proceed as follows:
 - Check that the center conductor is straight. Straighten if necessary.
 - Plug the connector straight into the receptacle.
 - Look through the slot in the outer receptacle, and watch the center conductor enter its receptacle as you insert the connector.
- Step 6: Replace the A3 Kernel board.

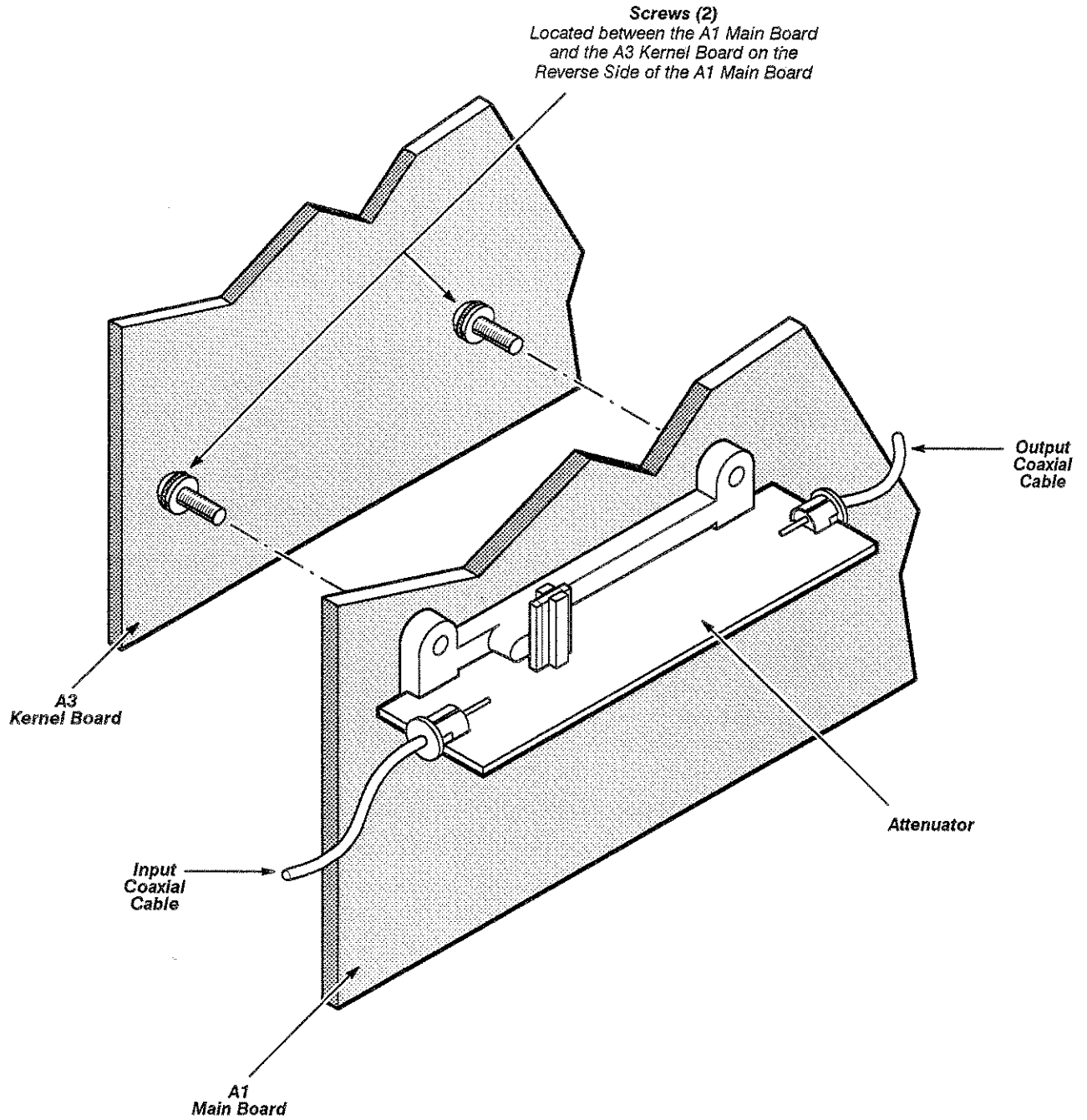

Figure 3-5 — Location of Screws and Parts for Removal of an Attenuator

Remove the A1 Main Board as follows:

- Step 1: Remove the A3 Kernel board.
- Step 2: Unplug the coaxial connector from the input of the Attenuator.
- Step 3: Unplug the probe information connectors from the A1 Main board: place your index finger under the metal contacts and your thumb on top, and lift the seven metal contacts out of the plastic block on the A1 Main board.
- Step 4: Use a narrow-shank, Torx T-10 screwdriver to remove the six screws and nut blocks that secure the A1 Main board to the top and bottom frames. Figures 3-6 and 3-7 show nut blocks.
- Step 5: Use a Torx T-15 screwdriver to remove the four screws that fasten the plastic rear panel to the top and bottom frames.
- Step 6: Carefully withdraw the A1 Main board from between the frames.
- Step 7: Remove the rear panel from the A1 Main board.

Install the A1 Main Board as follows:

- Step 8: Set the amplifier on its side with the pushbuttons up. Reinstall the rear panel on the A1 Main board.
- Step 9: Carefully insert the A1 Main board between the frames until the plastic rear panel contacts the top and bottom frames. The board fits on the top of the center ridges on the top and bottom frames.
- Step 10: Use a Torx T-15 screwdriver to install the four screws that fasten the rear panel to the top and bottom frames.
- Step 11: Use a Torx T-10 screwdriver to install the six screws and nut blocks that clamp the A1 Main board to the top and bottom frames.
- Step 12: Plug the probe information connector into its socket on the A1 Main board.
- Step 13: If you installed a new board without an attenuator, install one as outlined on page 3-13.
- Step 14: Install the A3 Kernel board.
- Step 15: If the A1 Main board has been replaced, then the Unit Identification (UID) number needs to be re-entered. Refer to Programming the Unit Identification later in this section.

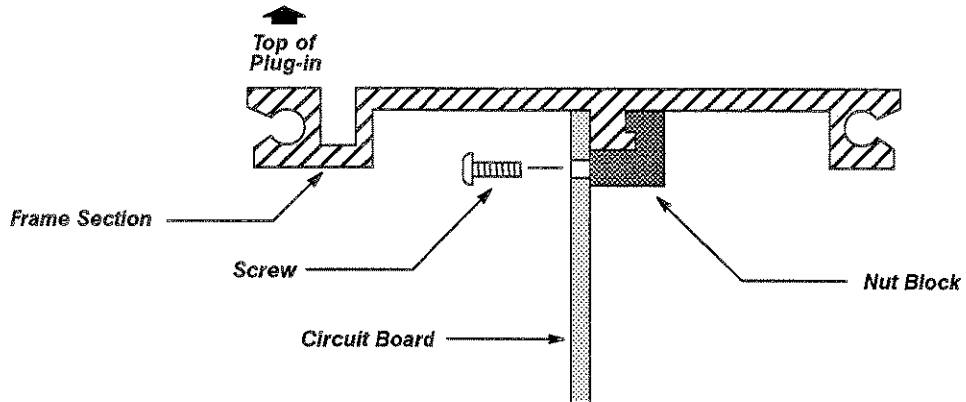

Figure 3-6 – Location of a Nut Block Securing the Circuit Board to the Frame Section

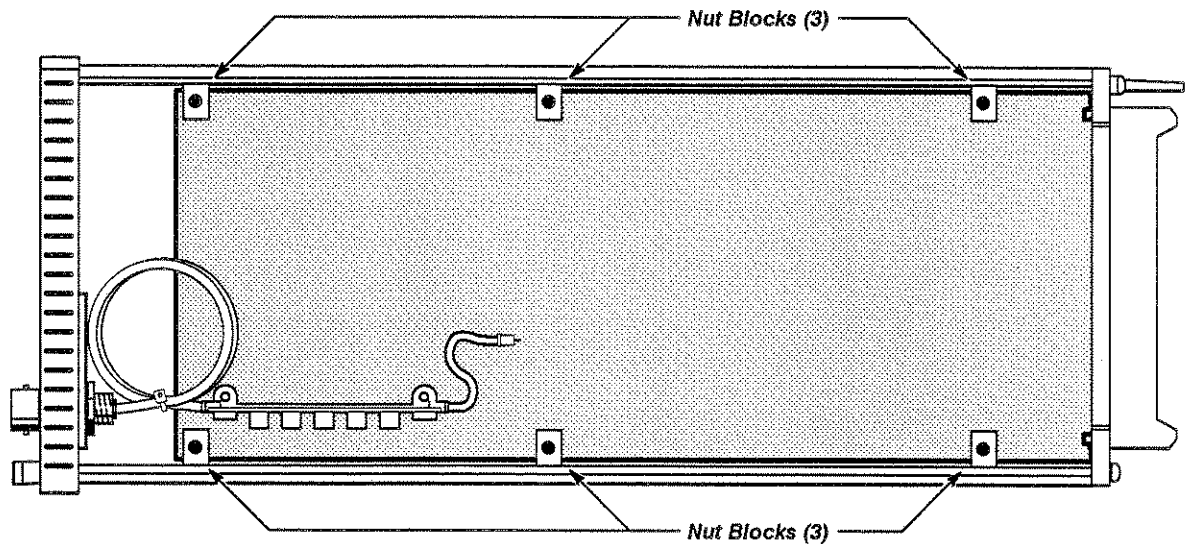

Figure 3-7 – Locations of the Nut Blocks for Removal of the A1 Main Board

Programming The Unit Identification

The Unit Identification (UID) is identical to the instrument's serial number and is stored in NV RAM. It is necessary to enter this number if the A1 Main board is replaced or if data in NV RAM becomes corrupted. If confirmation only of the UID is needed, then use the following procedure except skip Step 4.

To enter the UID, use this procedure:

- Step 1: Connect a Terminal to the mainframe's RS-232-C port. (Refer to the mainframe User's Reference Manual for instructions on setting up the RS-232-C parameters.)
- Step 2: Locate the UID jumper A3J400 on the A3 Kernel board (as shown in Fig. 3-1). The jumper should be on pins 2 and 3 in its normal position. Remove the jumper and install it on pins 1 and 2.

- Step 3: Install the amplifier into any compartment. Turn the power on. Wait until the Diagnostics checks are completed.
- Step 4: At the Terminal, type the command:

UID [Left | Center | Right]:“ < Serial Number > ”
 - Left | Center | Right refers to the name of the compartment.
- Step 5: At the Terminal, type the query:

UID? [Left | Center | Right]

Observe that the correct UID is reported.
- Step 6: Set the ON/STANDBY switch to STANDBY.
- Step 7: Remove the amplifier.
- Step 8: Reinstall the jumper A3J400 to its normal position on the K3 Kernel board.

BNC Connectors

Remove a Connector Assembly as follows:

- Step 1: Remove the front panel.
- Step 2: Unplug the coaxial connector from the back of the connector assembly. Figure 3-1 shows the locations of the connectors.
- Step 3: Unplug the cable from the A2 Front Panel board at the connector on the A1 Main board.
- Step 4: Unplug the probe information connectors from the A1 Main board: place your index finger under the metal contacts and your thumb on top, and lift the seven metal contacts out of the receptacle on the A1 Main board. (The probe information cable is a flat, flexible, seven-conductor cable.)
- Step 5: Use a Torx T-6 screwdriver to remove the four screws that fasten the connector assembly to the front subpanel.
- Step 6: Remove the connector assembly from the amplifier.

Install a Connector Assembly as follows:

- Step 1: Set the gray connector alignment ring on the connector with its index on the inside of the connector assembly. The “inside” is the side where the flat cable enters the connector assembly.
- Step 2: Insert the connector and the connector alignment ring into the hole in the front subpanel. Check that the flat cable faces the inside of the amplifier and the index on the connector alignment ring fits into the notch in the front subpanel.
- Step 3: Use a Torx T-6 screwdriver to install the four screws that fasten the connector assembly to the front subpanel.

- Step 4: Plug the probe information connector into its receptacle on the A1 Main board.
- Step 5: Plug the coaxial connector from the attenuator into the connector assembly. For best results, proceed as follows:
 - Check that the center conductor is straight. Straighten if necessary.
 - Plug the connector straight into the receptacle.
- Step 6: Plug the A2 Front Panel board cable connector into the A1 Main Board.
- Step 7: Install the front panel.

Multi-Pin Connectors

Pin 1 on a multi-pin connector is designated with a triangle (or arrowhead) on the holder. A square pad on the circuit board denotes pin 1. When a connection is made to a circuit board, the indexing of the triangle on the multi-pin holder is determined by the square pad.

The multi-pin connector is keyed by a gap between pins 1 and 3 in the holder. (A small plastic plug covers the pin 2 position on the end of the holder.) There is a corresponding gap between pins 1 and 3 on the circuit board as shown in Figure 3-8. The female connector is illustrated by this view. (The male connector also has a similar pin arrangement, but it is not shown.)

Align the holder plug with the gap between the circuit board pins. The connector is then ready to be installed.

The gray connector has a contrasting-color line along one side of its ribbon cable. This colored line represents the location of pin 1 or the triangle index mark on the connector.

To remove this connector, grasp the ends of the connector and pull it straight out from the circuit board. To install this connector, align the connector's color line with the square-shaped, circuit board pad, which is pin 1. Push the connector on the pins.

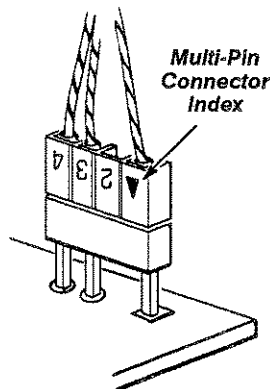

Figure 3-8 — Indexing of Multi-pin Connectors

Diagnostic Troubleshooting

This section provides the information necessary to troubleshoot a faulty instrument to the Field Replaceable Unit (FRU) level. FRUs are circuit boards, attenuator modules, and integrated circuits or hybrids that are replaceable without soldering. The primary means for troubleshooting is to use the error index code output from the Diagnostics or Self-Tests and cross-reference them to the suspect FRU(s) in the FRU Guide tables. After an FRU is replaced, some recalibration of the instrument is normally required (this is discussed further below).

Diagnostics Overview

The processor runs a set of Kernel Tests prior to the Self-Tests. If this is successful, then the Self-Tests run to verify the functionality of each of the subsystems. Any failure causes the instrument to enter Extended Diagnostics and to display the error index code(s) in a diagnostic menu. Extended Diagnostics tests are a superset of the Self-Tests.

The Kernel Tests, Self-Tests/Extended Diagnostics, and the Enhanced Accuracy mode produce and format error index codes differently, so they are covered separately.

Some of these tests that may indicate faulty FRUs are not run automatically during the Self-Tests (that is, some errors codes are only generated by manually selecting tests).

The next two subsections provide a quick overview of Kernel Tests and Extended Diagnostics.

Kernel Diagnostics — Each time the front-panel ON/STANDBY switch is set to ON, the mainframe and amplifiers perform Kernel Tests on their microprocessor subsystems and Self Test Diagnostics on all of their major circuits.

CAUTION

Turning the instrument power off during the execution of the Diagnostic tests may result in losing some or all of the non-volatile RAM data (such as stored settings, calibration constants, etc.). This could affect normal instrument operation in unpredictable ways. If this occurs, refer to Restoring Calibration Data later in this section.

After the amplifier is powered-up and the MPU has reset, the amplifier begins a sequence of test routines to determine if its kernel systems are operating properly. If any of these tests fails, then it is unlikely that the amplifier can communicate failure information to the mainframe. The flashing of a fault code on the front panel CH 1 LED indicates a particular failure. This fault code indicates which Kernel Test is failing.

The following description explains how to read the fault code:

- If the amplifier Kernel Tests detect a fault, then the CH 1 LED is flashed eight times to display a fault code. Each time the CH 1 LED turns on, count the occurrences. If the CH 1 LED is lit twice as long (that is, during one cycle, CH 1 is lit for twice the normal pulse width), then the test corresponding to the current count accumulated is the one which failed. Refer to the timing diagram in Figure 3-9 for an example LED fault code. The timing diagram illustrates a test number 2 failure.

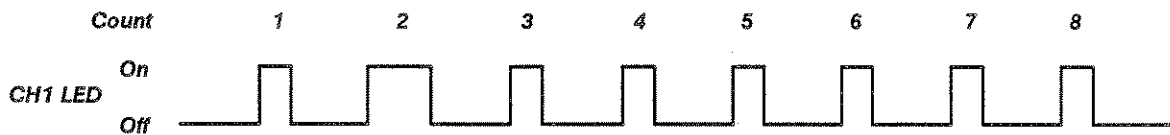

Figure 3-9 — Sample LED Fault Code Timing Diagram

The Kernel Tests are:

1. Non-volatile RAM Test
 2. Housekeeper IC Test
- **Test 1:** The non-volatile RAM (NV RAM) Test verifies that the NV RAM is functioning properly. Since the NV RAM contains calibration information which must remain undamaged, this test does not alter critical data. If the testing algorithm detects a failure, then the amplifier reports a fault code of 1, and repeatedly loops the NV RAM Test. The instrument continues looping the NV RAM Test until the power is removed. Until the condition causing the NV RAM Test to fail is corrected, the mainframe does not recognize the amplifier.

The NV RAM Test could corrupt calibration data stored in the NV RAM if the power is cycled or removed during this test. If corruption occurs, then the Calconstant Checksum is corrupted as well. Furthermore, at the next power-up, the amplifier resets the calibration constants to default ROM settings and reports an amplifier calconstant checksum error during mainframe-invoked, Power-up Diagnostics. After the mainframe/amplifier system is run through an Enhanced Accuracy cycle, the amplifier is once again properly calibrated.

- **Test 2:** The Housekeeper IC Test verifies the functionality of the Housekeeper IC. The Housekeeper IC performs many 'housekeeping' chores of the amplifier; including channel sequencing, refreshing the analog control voltage system, latching amplifier step gain settings, and the communications with the mainframe. This test exercises this IC and records the IC's reactions using an algorithm similar to the algorithm that signature analysis uses. If the resulting signature of the Housekeeper IC does not match a known good signature, then the test fails and reports a fault code of 3. Also, the test is executed repeatedly if it fails. The instrument continues looping the Housekeeper IC Test until power is removed. Until the condition causing the Housekeeper IC Test to fail is corrected, the mainframe does not recognize the amplifier.

After all power-on Kernel Tests have completed and successfully passed, the amplifier initializes its settings and communicates with the mainframe.

Self Test/Extended Diagnostics – First, the amplifier must successfully power-up, initialize its settings, and establish communication with the mainframe. Then, the mainframe requests that the amplifier execute its Self-Test routines (unless the mainframe's Self-Tests are disabled, in which case all the Self-Tests are ignored). Return to normal operation or entry into the New Configuration calibration, as discussed below, indicates successful completion of Self-Test Diagnostics. Any failures cause the instrument to display the Extended Diagnostics menu. Record the displayed error codes for the failed circuit block(s). You may have to step through several pages of the menu display to find all the failure codes.

The format of the error index codes is based on the Extended Diagnostics menu structure. The Extended Diagnostics menus are in a three level hierarchy with the Block menu at the highest level. Each amplifier is one Block. A Block is broken into a number of parts or circuit areas in the Area menu, the second level. Touching the Area label at the bottom of the menu displays the Area menu for the selected Block. Each circuit Area has a Routine menu, the third level, associated with it that has one or more selectable Routines. Routines are the smallest test units that are selectable and runnable. This Block, Area, and Routine menu hierarchy generates the error index codes.

Extended Diagnostics error index codes are five digit codes whose first character indicates the subsystem or amplifier tested. The last four digits are hexadecimal (hex) numbers that indicate the Block, Area, Routine and specific failure mode. For example, R1241 is decoded as follows:

R	Right plug-in
1	Block name – plug-in
2	Area name – Group I
4	Routine name – Checksum Probe
1	Failure Identity – specific failure mode

The subsystem character of an error index code is one of the following, and indicates the compartment in which the amplifier is installed. In the tables in this section, only the four digit failure code is listed; the prefix L, C, or R is omitted.

L	Left
C	Center
R	Right

Front-panel controls are active during the Self-Test sequence and any disturbance causes a test failure.

Self-Test Diagnostics test the following:

- Attenuator relay driver
- Probe coding
- Calibration constant checksums
- Calibration constant values
- A/D and D/A converters
- Probe power fuses
- Input protection

■ Signal path

Using the Self Tests/Extended Diagnostics – After all Extended Diagnostic/Self-Tests have run, any resultant error index codes appear on the display next to the associated circuit block names in the Extended Diagnostics menu. Each circuit block that had a failure gives the first error encountered and the number of failures in the Block. Select the label of a failed Block then select the Area label to get a more complete list of the error index codes in a Block. Selecting the Routine label shows the lowest level test routines in the selected Area. The currently selected Block, Area, and Routine are shown. Several operating mode selectors are available on the screen. When certain test routines are selected, some of these operating modes are unselectable.

Refer to the mainframe User's Reference manual for information on Extended Diagnostics or Extended Test menus and operation.

New Configuration Calibration

When an amplifier is first installed in a mainframe or when one is moved to a different compartment in the mainframe, the instrument is in a new configuration mode. After the instrument runs the Power-Up Diagnostics, it recalibrates itself for the new configuration. During this calibration, the message "**Powerup new configuration partial calibration occurring**" appears. If the calibration is successful (as indicated by a message), the instrument enters the normal operating mode.

Restoring Calibration Data

If the instrument power is turned off during probe calibration, self-calibration, Extended Diagnostics or other intense system activity, then some internal data may be corrupted. The display of the Extended Diagnostic menu when the power is turned on, indicates that this corruption has occurred.

If the Extended Diagnostics menu displays a Cksm Probe error (this error indicates that the power was turned off during probe calibration), then using the following procedure usually restores normal operation:

1. Note from the Extended Diagnostics menu which amplifier is at fault.
2. Exit the Extended Diagnostics menu.
3. Remove and re-install the probes on the amplifier that is at fault.
4. Repeat the calibration of these probes.
5. Run the Self-Tests and confirm that the tests pass.

If the Extended Diagnostics menu displays a Cksm Plug or any other new error, then using the following procedure usually restores normal operation:

1. Exit the Extended Diagnostic menu.
2. Wait for the self-calibration to complete and pass.
3. Run the Self-Tests and confirm that the tests pass.

Usually these procedure restore normal operation. If these procedures do not restore normal operation, then your mainframe or amplifier requires servicing.

Amplifier Memory Backup Power

The non-volatile RAM (A1U801 NV RAM) within the amplifier allows retention of the data in memory when the mainframe power is removed.

NV RAM stores system-configuration data such as the amplifier, mainframe, and probe IDs as well as the calibration constants. The data that the NV RAM stores, enable the amplifier to resume Enhanced Accuracy performance from a powered-down condition, without performing a full calibration (Enhanced Accuracy) operation.

The rated lifetime of the NV RAM's integral power source is ten years. If, on system power-up, the amplifier habitually loses Enhanced Accuracy status without a system configuration change (that is, the amplifier remains plugged into the same slot in the same mainframe), then the NV RAM might require replacement.

Field Replaceable Unit (FRU) Guide

This section correlates error index codes resulting from Diagnostic tests with the hybrid, integrated circuit (IC), module, or board FRU(s) suspected of causing each error. The FRU(s) in each category are listed in most-to-least probable cause order (assuming only one error is indicated). If any diagnostic errors occur, inspect the suspect FRU for loose connections and components. Repeat the Diagnostic test. If any diagnostic errors occur again, replace the suspect FRU(s) with a known good FRU(s). Verify that the new FRU is a correct replacement for the old FRU. If the old FRU contains firmware, then verify that the new firmware version is either the same version as, or an upgraded version of, the old firmware version.

Abbreviations of FRU Names—All boards are listed here with the abbreviation used in the FRU tables below:

Table 3-2 – Board FRU

<i>Abbreviation</i>	<i>Name</i>	<i>Designator</i>
Main	Main board	A1
Front	Front Panel board	A2
Kernel	Kernel board	A3

Abbreviations of Component and Module Names—All active components and modules are listed here with the abbreviation used in the FRU tables below.

Table 3-3 — Component/Module FRUs

<i>Abbreviation</i>	<i>Name</i>	<i>Designator</i>
MPU	Processor	A3U500
EPROM	Firmware	A3U800
RAM	Memory	A3U700
HK	Housekeeper	A3U820
Att	Attenuator	
FUSE	Probe power fuses	A1F100, A1F110, A1F111, A1F112

Error Index Codes—This table lists the error codes possible in the Kernel Tests.

Table 3-4 — Amplifier Kernel Error Index Codes

<i>Error Code</i>	<i>Suspect Module, Hybrid, or IC FRU(s)</i>	<i>Suspect Board FRU(s)</i>
1	RAM ¹	Kernel
2	HK, MPU	Kernel

¹When the RAM is replaced a new User Identification (UID) must be entered before this error can be cleared. See Programming the Unit Identification.

This table lists the error messages possible in the Self-Tests and Extended Diagnostics.

Table 3-5 – Self-Tests/Extended Diagnostics Error Index Codes

<i>Routine</i>	<i>Area</i>	<i>Error Index</i>	<i>Suspect Module, Hybrid, or IC FRU(s)</i>	<i>Suspect Board FRU(s)</i>
Relay Dvr	Group I	-1111		Kernel
Probecodes	Group I	-1121		Kernel
Cksm Plug	Group I	-1131 ²	RAM ¹	Kernel
Cksm Probe	Group I	-1141 ²	RAM ¹	Kernel
Serial Sum	Group I	-1151	RAM ¹	Kernel
ADC Test	Group II	-1211		Kernel
Fuse Test	Group II	-1221	FUSE	Kernel
Protection	Group II	-1231	HK	Main, Kernel
ACUS Test	Group III	-1311	HK	Kernel
Cal Measure	Meas Sys	-1511		Main, Kernel
Cal Sigpth	Meas Sys	-1521	Att	Main

¹When the RAM is replaced a new User Identification (UID) must be entered before this error can be cleared. See Programming the Unit Identification.

²These error indexes may also result from corruption of calibration data (refer to Restoring Calibration Data earlier in this section).

Interconnections are not listed but should be considered as possible problem sources.

Report errors by Routine and Error names to your Service Center.

This table lists the error messages resulting from Enhanced Accuracy. Enhanced Accuracy is available after the system has a 20-minute warmup period.

Table 3-6 – Self-Tests/Extended Diagnostics Error Index Codes

<i>Routine</i>	<i>Area</i>	<i>Error Index IC FRU(s)</i>	<i>Suspect Hybrid/ FRU(s)</i>	<i>Suspect Board FRU(s)</i>
Probe Gain	Ch 1 Cal	-1411	Att	
Atten Gain	Ch 1 Cal	-1421	Att	
Gain High	Ch 1 Cal	-1431		Main
Gain Low	Ch 1 Cal	-1441		Main
Balance	Ch 1 Cal	-1451		Main
Coarse DAC	Ch 1 Cal	-1461		Main
Att Offset	Ch 1 Cal	-1471		Main

Fuse Troubleshooting

Failure code 1221 indicates that one or more probe power fuses are defective.

Refer to Figure 3-1 (FRU locator) for fuse locations.

To find a defective fuse, remove the amplifier from the mainframe, and use a Multimeter to check for continuity across each fuse. Replace all defective fuses. Then, install the amplifier in the mainframe and verify that the diagnostic error does not reappear.

The most likely cause of a blown fuse is a short circuit applied at the front-panel TEKPROBE® input connector. If a newly installed fuse blows with nothing connected at the TEKPROBE® input connector, then look for a short circuit on the A1 Main board or on the flexible circuit connecting the A1 Main board to the TEKPROBE® input connector.

Jumpers

Two jumpers are installed in the instrument for normal operation. Refer to Figure 3-1, and verify that they are properly installed.

A3J400

A3J410

Theory of Operation

The Tektronix 11A71 Amplifier is a wide bandwidth amplifier that plugs into any 11000-Series Oscilloscope and accommodates amplifiers.

Block Diagram Description

This section describes and illustrates (refer to Fig. 4-1) the amplifier block diagram; including signal flow and control flow. This section also discusses the power supplies for the amplifier.

Signal Flow

The signal flow begins in the main board and proceeds as described in the following paragraphs.

Main Board—The signal display begins with the application of a signal directly to the CH 1 input connector on the Main board (possibly with a probe) and proceeds as follows:

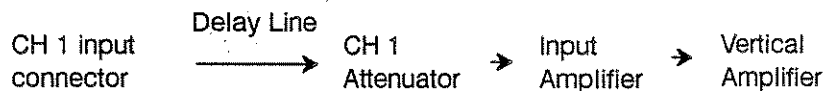

The input coupling mode is either AC, DC, or Off. In the AC and DC coupling modes, the input signal is coupled to the Attenuator. In the Off coupling mode, the signal path is open.

During self-calibration, the mainframe supplies the signal to the CH 1 input connector and the coupling mode is set to Off.

The CH 1 Attenuator contains resistive dividers, an ac coupling capacitor, and relays.

The Attenuator has 2X, 5X, and 10X attenuation sections, which are connected to produce 2X, 5X, 10X, 20X, 50X or 100X attenuation.

The Fast Protection circuit protects the Input Amplifier from fast-rise, high-amplitude input signals that could cause damage to the Input Amplifier.

Kernel Board to Main Board—The Kernel board contains a microprocessor (MPU) that communicates with the mainframe. The MPU constantly monitors the input Overload Sense and the Probe Data communication lines. The MPU operates through the internally stored program in its read only memory (ROM). The MPU stores the amplifier calibration (cal) constants in random access memory (RAM). A battery backs-up random access memory (RAM) memory, therefore, the internal calibration constants are not lost upon power-down. Also, when powering-down, the mainframe stores the oscilloscope's settings. When the system re-powers, the mainframe restores and transmits these settings to the amplifier.

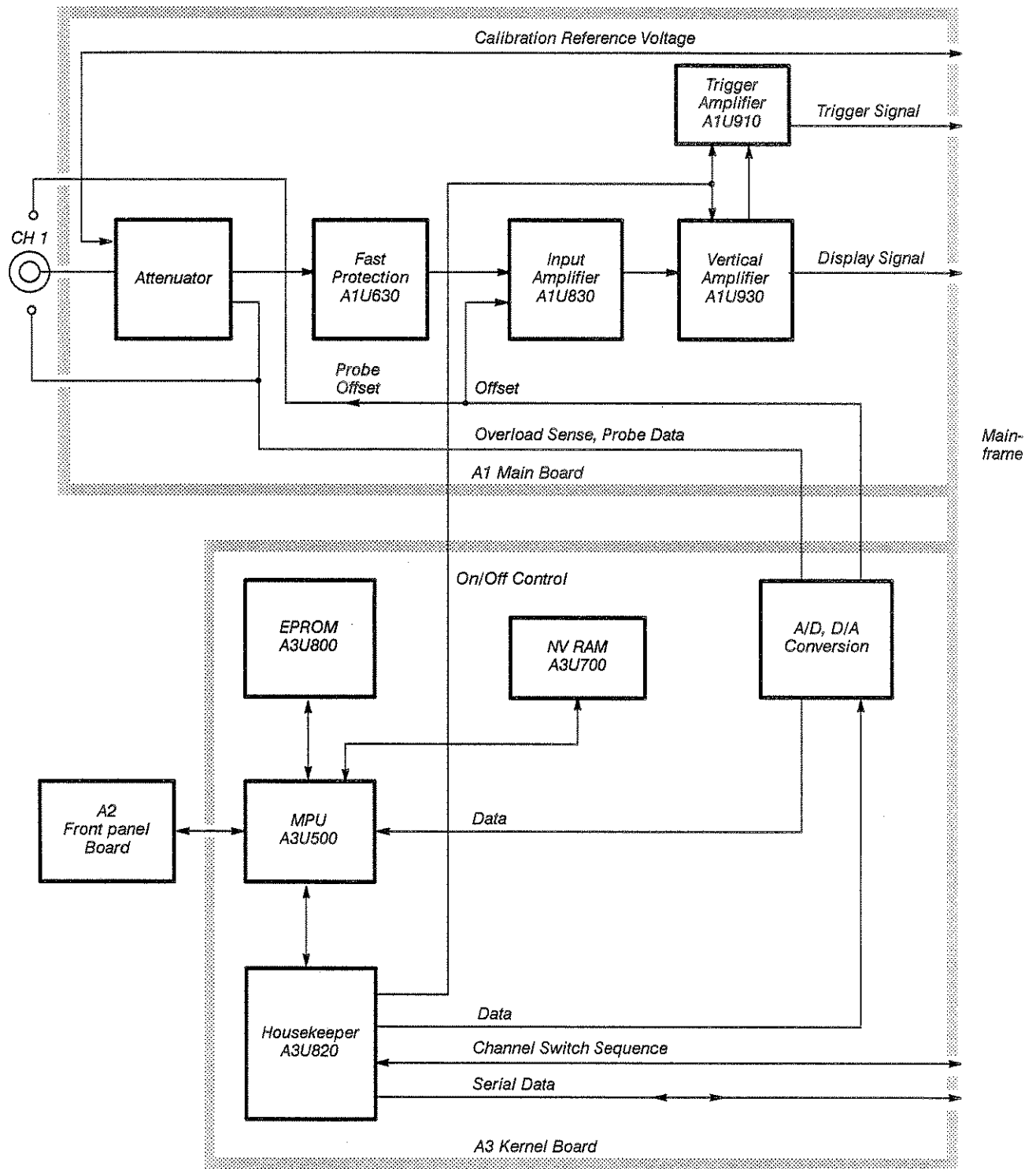

Figure 4-1 – 11A71 Amplifier Block Diagram

The MPU communicates with the mainframe through a peripheral IC called the Housekeeper. The Housekeeper converts the 8-bit data bytes from the MPU into a serial data signal. This signal is sent to the mainframe. Conversely, the Housekeeper converts the serial data signal from the mainframe into 8-bit data bytes for the MPU to read. The MPU stores the channel switching sequence in the Housekeeper. The Housekeeper also updates the analog control voltages.

The MPU uses an analog-to-digital (A/D) converter to read the value of the Overload Sense and Probe Data lines. The A/D converter is also used in the Self-Tests.

The MPU reads the front-panel pushbuttons. The MPU tells the mainframe when a front-panel button is pushed. The mainframe then tells the amplifier what action to take (for example, display the channel and turn on the channel's respective front-panel LED).

Control Flow

Under the control of the mainframe's channel switch sequencing signals, the Housekeeper sequentially turns the outputs on or off.

If the amplitude of the input signal is excessive, the Kernel board switches the coupling mode to Off.

On/Off signals from the Kernel board independently control both the Vertical and Trigger Amplifiers.

The Kernel board also provides dc balance, dc offset, and gain adjust signals to the Input Amplifier and controls the Attenuator.

Power

The mainframe supplies all the power to the amplifier.

Replaceable Parts

This section contains a list of the components that are replaceable for the 11A71 Amplifier. As described below, use this list to identify and order replacement parts.

Parts Ordering Information

Replacement parts are available from or through your local Tektronix, Inc. service center or representative.

Changes to Tektronix instruments are sometimes made to accommodate improved components as they become available and to give you the benefit of the latest circuit improvements. Therefore, when ordering parts, it is important to include the following information in your order:

- Part number
- Instrument type or model number
- Instrument serial number
- Instrument modification number, if applicable

If a part you order has been replaced with a different or improved part, your local Tektronix service center or representative will contact you concerning any change in the part number.

Change information, if any, is located at the rear of this manual.

Module Replacement

The 11A71 Amplifier is serviced by module replacement so there are three options you should consider:

- **Module Exchange.** In some cases you may exchange your module for a remanufactured module. These modules cost significantly less than new modules and meet the same factory specifications. For more information about the module exchange program, call 1-800-TEKWIDE, ext. BV 5799.
- **Module Repair.** You may ship your module to us for repair, after which we will return it to you.
- **New Modules.** You may purchase new replacement modules in the same way as other replacement parts.

Using the Replaceable Parts List

The tabular information in the Replaceable Parts List is arranged for quick retrieval. Understanding the structure and features of the list will help you find the all the information you need for ordering replacement parts.

Item Names

In the Replaceable Parts List, an Item Name is separated from the description by a colon (:). Because of space limitations, an Item Name may sometimes appear as incomplete. For further Item Name identification, U.S. Federal Cataloging Handbook H6-1 can be used where possible.

Indentation System

This parts list is indented to show the relationship between items. The following example is of the indentation system used in the Description column:

1	2	3	4	5	Name & Description
					<i>Assembly and/or Component</i>
					<i>Attaching parts for Assembly and/or Component</i> <i>(END ATTACHING PARTS)</i>
					<i>Detail Part of Assembly and/or Component</i>
					<i>Attaching parts for Detail Part</i> <i>(END ATTACHING PARTS)</i>
					<i>Parts of Detail Part</i>
					<i>Attaching parts for Parts of Detail Part</i> <i>(END ATTACHING PARTS)</i>

Attaching parts always appear at the same indentation as the item it mounts, while the detail parts are indented to the right. Indented items are part of, and included with, the next higher indentation. Attaching parts must be purchased separately, unless otherwise specified.

Abbreviations

Abbreviations conform to American National Standards Institute (ANSI) standard Y1.1

CROSS INDEX - MFR. CODE NUMBER TO MANUFACTURER

Mfr. Code	Manufacturer	Address	City, State, Zip Code
06383	PANDUIT CORP	17301 RIDGELAND	TINLEY PARK IL 07094-2917
22599	AMERACE CORP ESNA DIV	15201 BURBANK BLVD SUITE C	VAN NUYS CA 91411-3532
34649	INTEL CORP SALES OFFICE /ST4-2/	3065 BOWERS AVE	SANTA CLARA CA 95051
75915	LITTELFUSE INC SUB TRACOR INC	800 E NORTHWEST HWY	DES PLAINES IL 60016-3049
80009	TEKTRONIX INC	14150 SW KARL BRAUN DR PO BOX 500	BEAVERTON OR 97077-0001
83385	MICRODOT MFG INC GREER-CENTRAL DIV	3221 W BIG BEAVER RD	TROY MI 48098
91260	CONNOR SPRING AND MFG CO A SLOSS AND BRITTAN INC CO	1729 JUNCTION AVE	SAN JOSE CA 95112
92101	SCHULZE MFG	50 INGOLD RD	BURLINGAME CA 94010-2206
93907	TEXTRON INC CAMCAR DIV	600 18TH AVE	ROCKFORD IL 61108-5181
TK1326	NORTHWEST FOURSLIDE INC	18224 SW 100TH CT	TUALATIN OR 97062
TK1831	PACIFIC HYBRID MICROELECTRONICS INC	7790 SW NIMBUS AVE BLDG 10	BEAVERTON OR 97005

Fig. & Index No.	Tektronix Part No.	Serial/Assembly No.		Qty	12345 Name & Description	Mfr.	
		Effective	Discont			Code	Mfr. Part No.
1-1	366-0600-00			1	PUSH BUTTON:0.269 X 0.409,ABS	80009	366-0600-00
-2	366-1058-00			1	KNOB:GRAY,0.625 X 0.255 X 0.485 (ATTACHING PARTS)	80009	366-1058-00
-3	214-1095-00			1	PIN,SPRING:0.187 L X 0.094 OD,STL,CD PL (END ATTACHING PARTS)	22599	52-022-094-0187
-4	105-0076-04			1	RELEASE BAR,LCH:PLUG-IN UNIT	80009	105-0076-04
-5	214-1280-00			1	SPRING,HLCPS:0.14 OD X 1.126 L,TWIST LOOP	91260	ORDER BY DESCR
-6	214-1054-00			1	SPRING,FLAT:0.825 X 0.322,SST	TK1326	ORDER BY DESCR
-7	105-0075-00			1	BOLT,LATCH:	80009	105-0075-00
-8	333-3409-00			1	PANEL,FRONT: (ATTACHING PARTS)	80009	333-3409-00
-9	211-0392-00			4	SCREW,MACHINE:4-40 X 0.25,FLH,82 DEG,STL (END ATTACHING PARTS)	80009	211-0392-00
-10	348-0235-00			2	SHLD GSKT,ELEK:FINGER TYPE,4.734 L	92101	ORDER BY DESCR
-11	386-5219-00			1	SUBPANEL,FRONT:	80009	386-5219-00
-12	670-9336-00			1	CIRCUIT BD ASSY:FRONT PANEL (SEE A2) (ATTACHING PARTS)	80009	670-9336-00
-13	211-0398-00	B010100	B010508	2	SCREW,MACHINE:2-56 X 0.312,FLH,82 DEG,STL	80009	211-0398-00
	211-0413-00	B010509		2	SCREW,MACHINE:2-56 X 0.375,FLH,82 DEG,STL (END ATTACHING PARTS)	93907	ORDER BY DESCR
-14	174-0159-00			1	CA ASSY,SP,ELEC:6,26 AWG,3.0 L,RIBBON	80009	174-0159-00
-15	426-2061-00			1	FR SECT,PLUG-IN:LOWER,ALUMINUM	80009	426-2061-00
-16	334-3540-00			1	MARKER,IDENT:MARKED WARNING	80009	334-3540-00
-17	131-3589-00			1	CONN ASSY,ELEC:FRONT PNL (ATTACHING PARTS)	80009	131-3589-00
-18	211-0398-00	B010100	B010508	4	SCREW,MACHINE:2-56 X 0.312,FLH,82 DEG,STL	80009	211-0398-00
	211-0413-00	B010509		4	SCREW,MACHINE:2-56 X 0.375,FLH,82 DEG,STL (END ATTACHING PARTS)	93907	ORDER BY DESCR
-19	354-0654-00			1	RING,CONN ALIGN:BNC	80009	354-0654-00
-20	174-0205-00			1	CABLE ASSY,RF:50 OHM COAX,2.6 L	80009	174-0205-00
	174-0665-00			1	CABLE ASSY,RF:50 OHM COAX,13.3 L	80009	174-0665-00
	343-0549-00			1	STRAP,TIEDOWN,E:0.091 W X 4.0 L,ZYTEL	06383	PLT1M
-21	119-2397-00			1	ATTENUATOR:5 STAGE PROGRAMMABLE (ATTACHING PARTS)	TK1831	119-2397-00
-22	211-0409-00			2	SCR,ASSEM WSHR:4-40 X 0.312,PNH,STL (END ATTACHING PARTS)	93907	ORDER BY DESCR
-23	174-0559-00			1	CA ASSY,SP,ELEC:20,28 AWG,2.25 L,RIBBON	80009	174-0559-00
-24	426-2060-00			1	FR SECT,PLUG-IN:UPPER,ALUMINUM	80009	426-2060-00
-25	334-3438-00			1	MARKER,IDENT:MARKED TURN OFF POWER	80009	334-3438-00
-26	214-1061-00			1	CONTACT,ELEC:GROUNDING,CU BE	80009	214-1061-00
-27	337-1064-12			2	SHIELD,ELEC:SIDE FOR PLUG-IN UNIT	80009	337-1064-12
-28	220-0022-00			6	NUT BLK:0.4 X 0.25 X 0.33,4-40 THRU,NI SIL (ATTACHING PARTS)	80009	220-0022-00
-29	211-0409-00			6	SCR,ASSEM WSHR:4-40 X 0.312,PNH,STL (END ATTACHING PARTS)	93907	ORDER BY DESCR
-30	174-0560-00			1	CA ASSY,SP,ELEC:16,28 AWG,2.75 L,RIBBON	80009	174-0560-00
-31	670-9747-00			1	CIRCUIT BD ASSY:KERNEL (SEE A3) (ATTACHING PARTS)	80009	670-9747-00
-32	211-0409-00			4	SCR,ASSEM WSHR:4-40 X 0.312,PNH,STL (END ATTACHING PARTS)	93907	ORDER BY DESCR
					KERNAL BOARD ASSEMBLY INCLUDES:		
-33	156-1684-01			1	.MICROCKT,DGTL:MICROCOMPUTER,8 BIT	34649	P8031AH
-34	156-2625-00			1	.MICROCKT,DGTL:NMOS,CUSTOM,SENESCHAL	80009	156-2625-00
-35	160-4065-02	B010100	B010196	1	.MICROCKT,DGTL:H MOS,16385 X 8 EPROM,PRGM	80009	160-4065-02
	160-4065-03	B010197	B011287	1	.MICROCKT,DGTL:H MOS,16385 X 8 EPROM,PRGM	80009	160-4065-03
	160-4065-04	B011288	B011318	1	.MICROCKT,DGTL:H MOS,16385 X 8 EPROM,PRGM	80009	160-4065-04
	160-4065-05	B011319	B011563	1	.MICROCKT,DGTL:H MOS,16385 X 8 EPROM,PRGM	80009	160-4065-05
	160-4065-06	B011564	B011994	1	.MICROCKT,DGTL:H MOS,16385 X 8 EPROM,PRGM	80009	160-4065-06
	160-4065-07	B011995	B012182	1	.MICROCKT,DGTL:H MOS,16385 X 8 EPROM,PRGM	80009	160-4065-07
	160-4065-08	B012183		1	.MICROCKT,DGTL:H MOS,16385 X 8 EPROM,PRGM	80009	160-4065-08
-36	156-2671-00			1	.MICROCKT,DGTL:CMOS,2048 X 8 SRAM MDL W/ .INTEGRAL BATTERY DS1220,24	80009	156-2671-00
-37	670-9735-00	B010100	B010508	1	CIRCUIT BD ASSY:MAIN	80009	670-9735-00
	670-9735-01	B010509		1	CIRCUIT BD ASSY:MAIN (SEE A1)	80009	670-9735-01
-38	159-0253-00			2	.FUSE,CARTRIDGE:0.250A,125V,FAST,SUBMIN	75915	251.250 T & R T1

Fig. & Index No.	Tektronix Part No.	Serial/Assembly No. Effective Dscnt	Qty	12345 Name & Description	Mfr. Code	Mfr. Part No.
1-39	159-0235-00		2	.FUSE,WIRE LEAD:0.75A,125V,FAST	80009	159-0235-00
-40	386-5296-00		1	PANEL,REAR: (ATTACHING PARTS)	80009	386-5296-00
-41	213-0904-00		4	SCREW,TPG,TR:6-32 X 0.5,PNH,STL (END ATTACHING PARTS)	83385	ORDER BY DESCR
STANDARD ACCESSORIES						
	070-6288-01		1	MANUAL,TECH:USERS REFERENCE,11A71	80009	070-6288-01
	070-6699-01		1	PROCEDURE:INCOMING INSPECTION,11A71	80009	070-6699-01
OPTIONAL ACCESSORIES						
	070-6787-01		1	MANUAL,TECH:SERVICE REF,11A71	80009	070-6787-01

Free Manuals Download Website

<http://myh66.com>

<http://usermanuals.us>

<http://www.somanuals.com>

<http://www.4manuals.cc>

<http://www.manual-lib.com>

<http://www.404manual.com>

<http://www.luxmanual.com>

<http://aubethermostatmanual.com>

Golf course search by state

<http://golfingnear.com>

Email search by domain

<http://emailbydomain.com>

Auto manuals search

<http://auto.somanuals.com>

TV manuals search

<http://tv.somanuals.com>