



**PLEASE CHECK FOR CHANGE INFORMATION
AT THE REAR OF THIS MANUAL.**

7A18A DUAL TRACE AMPLIFIER

INSTRUCTION MANUAL

**Tektronix, Inc.
P.O. Box 500
Beaverton, Oregon 97077**

070-4329-00
Product Group 42

Serial Number _____

First Printing OCT 1982
Revised MAR 1985

Copyright © 1971 , 1982 Tektronix, Inc. All rights reserved.
Contents of this publication may not be reproduced in any
form without the written permission of Tektronix, Inc.

Products of Tektronix, Inc. and its subsidiaries are covered
by U.S. and foreign patents and/or pending patents.

TEKTRONIX, TEK, SCOPE-MOBILE, and  are
registered trademarks of Tektronix, Inc. TELEQUIPMENT
is a registered trademark of Tektronix U.K. Limited.

Printed in U.S.A. Specification and price change privileges
are reserved.

INSTRUMENT SERIAL NUMBERS

Each instrument has a serial number on a panel insert, tag,
or stamped on the chassis. The first number or letter
designates the country of manufacture. The last five digits
of the serial number are assigned sequentially and are
unique to each instrument. Those manufactured in the
United States have six unique digits. The country of
manufacture is identified as follows:

B000000	Tektronix, Inc., Beaverton, Oregon, USA
100000	Tektronix Guernsey, Ltd., Channel Islands
200000	Tektronix United Kingdom, Ltd., London
300000	Sony/Tektronix, Japan
700000	Tektronix Holland, NV, Heerenveen, The Netherlands

LIST OF ILLUSTRATIONS

Fig. No.		Page
2-1	Front-panel controls and connectors	2-1
2-2	Measuring the peak-to-peak voltage of a waveform	2-4
2-3	Measuring instantaneous voltage with respect to some reference	2-5
2-4	Measuring phase difference between two signals.	2-7
2-5	High resolution phase measurement using time-base magnifier	2-7
2-6	Using the ADD mode for common-mode rejection	2-8
3-1	Channel 1 Input Amplifier detailed block diagram	3-2
3-2	Channel 2 Input Amplifier detailed block diagram	3-4
3-3	U270 input combinations for DISPLAY MODE selection	3-5
3-4	Input/Output combinations for DISPLAY MODE and TRIGGER SOURCE switch selections	3-5
4-1	Locations of adjustments used in this procedure	4-9
5-1	Electrode configuration for semiconductors used in this instrument	5-2
6-1	7A18A Option 06	6-1
6-2	Side view of 7A18A—Option 06	6-3
6-3	Rear view of A2-Amplifier board for either Option 06 or standard 7A18A	6-3

8-1 and 8-2 are of circuit board assemblies and are in the diagrams section

OPERATORS SAFETY SUMMARY

The general safety information in this part of the summary is for both operating and servicing personnel. Specific warnings and cautions will be found throughout the manual where they apply, but may not appear in the summary.

Terms in This Manual

CAUTION statements identify conditions or practices that could result in damage to the equipment or other property.

WARNING statements identify conditions or practices that could result in personal injury or loss of life.

Terms as Marked on Equipment

CAUTION indicates a personal injury hazard not immediately accessible as one reads the marking, or a hazard to property including the equipment itself.

DANGER indicates a personal injury hazard immediately accessible as one reads the marking.

Symbols In This Manual



This symbol indicates where applicable cautionary or other information is to be found.

Symbols As Marked On Equipment



DANGER - High voltage.



Protective ground (earth) terminal.



ATTENTION - refer to manual.

Power Source

This product is intended to operate from a power source that will not apply more than 250 volts rms between the

supply conductors or between either supply conductor and ground. A protective ground connection by way of the grounding conductor in the power cord is essential for safe operation.

Grounding the Product

This product is grounded through the grounding conductor of the power cord. To avoid electrical shock, plug the power cord into a properly wired receptacle before connecting to the product input or output terminals. A protective ground connection by way of the grounding conductor in the power cord is essential for safe operation.

Danger Arising From Loss Of Ground

Upon loss of the protective-ground connection, all accessible conductive parts (including knobs and controls that may appear to be insulating) can render an electric shock.

Use The Proper Power Cord

Use only the power cord and connector specified for your product.

Use only a power cord that is in good condition.

Refer cord and connector changes to qualified service personnel.

Use The Proper Fuse

To avoid fire hazard, use only the fuse of correct type, voltage rating and current rating as specified in the parts list for your product.

Refer fuse replacement to qualified service personnel.

Do Not Operate In Explosive Atmospheres

To avoid explosion, do not operate this product in an explosive atmosphere unless it has been specifically certified for such operation.

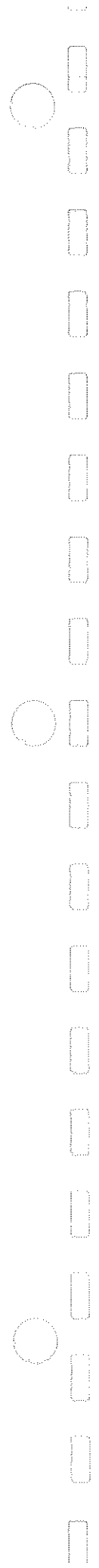

SERVICE SAFETY SUMMARY

FOR QUALIFIED SERVICE PERSONNEL ONLY

Refer also to the preceding Operators Safety Summary

Do Not Service Alone

Do not perform internal service or adjustment of this product unless another person capable of rendering first aid and resuscitation is present.

Use Care When Servicing With Power On

Dangerous voltages exist at several points in this product. To avoid personal injury, do not touch exposed connections and components while power is on.

Disconnect power before removing protective panels, soldering, or replacing components.

Power Source

This product is intended to operate from a power source that will not apply more than 250 volts rms between the supply conductors or between either supply conductor and ground. A protective ground connection by way of the grounding conductor in the power cord is essential for safe operation.

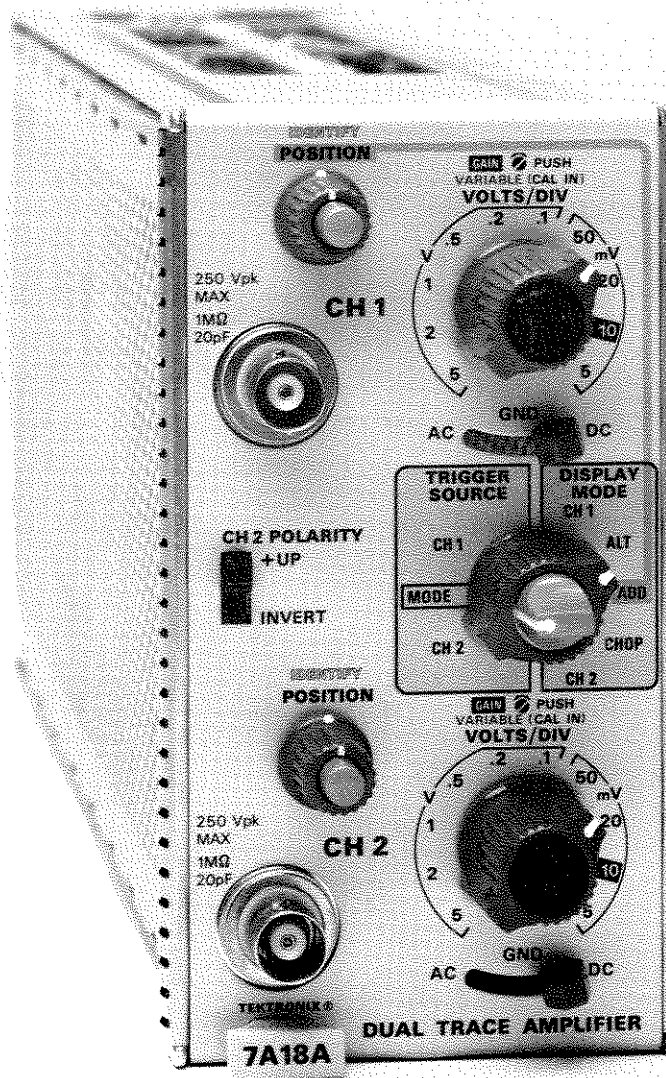

4329-01

7A18A Dual Trace Amplifier

SPECIFICATION

Introduction

The 7A18A Dual Trace Amplifier plug-in unit is designed for use with TEKTRONIX 7000-Series Oscilloscopes.

The 7A18A is a dual-channel, medium-bandwidth amplifier. Internal gain and compensation circuits are automatically switched to correspond to the setting of the VOLTS/DIV

switch. Channel 2 can be inverted for differential measurements. The 7A18A can be operated in any plug-in compartment of the 7000-Series Oscilloscopes.

The following electrical characteristics are valid over the stated environmental range for instruments calibrated at an ambient temperature of +20°C to +30°C, and after a five minute warmup unless otherwise noted.

Table 1-1
ELECTRICAL

Characteristic	Performance Requirement	Supplemental Information
Deflection Factor		
Calibrated Range	5 mV/Div to 5 V/Div; ten steps in a 1,2,5 sequence.	
Deflection Factor Accuracy	Within 2% with GAIN adjusted at 10 mV/Div.	
Uncalibrated (VARIABLE)	Continuously variable between calibrated steps; extends deflection factor to at least 12.5 V/Div.	
GAIN		Permits adjustment of deflection factor for calibrated operation with all 7000-series oscilloscopes.
Frequency Response System Dependent (8 div reference signal)		
Upper Bandwidth DC (Direct) Coupled	75 MHz	
Lower Bandwidth AC (Capacitive) Coupled	10 Hertz or less	
With 10X Probe	1 Hertz or less	
Maximum Input Voltage		
DC Coupled	250 volts, (DC + Peak AC); AC component 500 volts peak-to-peak maximum, one kilohertz or less.	
AC Coupled	500 volts, (DC + Peak AC); AC component 500 volts peak-to-peak maximum, one kilohertz or less.	
Channel Isolation	50:1 display ratio up to 50 megahertz.	

Table 1-1 (cont)

Characteristics	Performance Requirements	Supplemental Information
Input R and C		
Resistance	1 MΩ ±2%.	
Capacitance	Approximately 20.0 pF	
RC Product		Within ±1% between all deflection factors.
Displayed Noise (Tangentially Measured)	0.06 div or less at all deflection factors	
Overdrive Recovery Time	0.1 ms or less to recover to within one division after the removal of an overdrive signal of up to +75 divisions or -75 divisions regardless of overdrive signal duration.	
Common Mode Rejection Ratio	At least 10:1 up to 50 megahertz.	
DC Drift		
Drift with Time (Ambient temperature and line voltage constant)	0.02 division or less in any one minute, after one hour warmup.	
Drift with Temperature (line voltage constant)	Nor more than 0.01 division per degree C.	
Time Delay between Channels	700 picoseconds or less.	
Display Modes	Channel 1 only. Dual-trace, alternate between channels. Added algebraically. Dual-trace chopped between channels. Channel 2 only.	
Trigger source Selection	Channel 1 only. Follows DISPLAY MODE selection. Channel 2 only.	

Table 1-2
ENVIRONMENTAL CHARACTERISTIC

Refer to the Specification for the associated oscilloscope.

Table 1-3
PHYSICAL

Size	Fits all 7000-series plug-in compartments.
Weight	≈2 Pounds 10 Ounces (1.4 kilograms)

OPERATING INSTRUCTIONS

General

To effectively use the 7A18A, the operation and capabilities of the instrument must be known. This section describes front-panel control functions, general information on signal input connections, and other subjects that pertain to various measurement applications.

Installation

The 7A18A is calibrated and ready for use as received. It can be installed in any compartment of Tektronix 7000-Series oscilloscopes, but is intended for principal use in vertical plug-in compartments. To install, align the upper and lower rails of the 7A18A with the oscilloscope tracks and fully insert it. The front will be flush with the front of the oscilloscope when the 7A18A is fully inserted, and the latch at the bottom-left corner of the 7A18A will be in place against the front panel.

To remove the 7A18A, pull on the latch (which is inscribed with the unit identification "7A18A") and the 7A18A will unlatch. Continue pulling on the latch to slide the 7A18A out of the oscilloscope.

FRONT PANEL CONTROLS AND CONNECTORS

The following descriptions apply to the controls and connectors of both Input Amplifier channels when applicable. See Fig. 2-1.

Input Connector	Provides signal connection to the channel.
AC-GND-AC	Selects signal input coupling mode.
	AC—The AC component of the signal is coupled to the amplifier input while the DC component is blocked.
	GND—Grounds the amplifier input while maintaining the same load for the input signal. Provides a charge path for the AC coupling capacitor to precharge the input circuit before switching the input to AC.

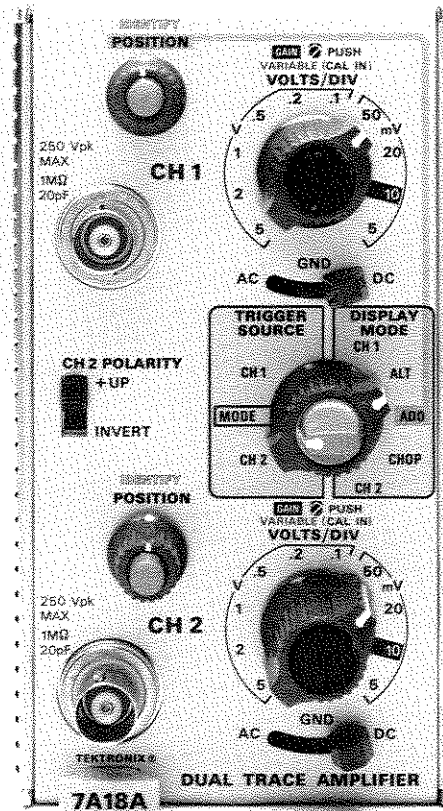

4329-02

Fig. 2-1. Front-panel controls and connectors. (7A18A shown.)

	DC—Both AC and DC components of the signal are coupled to the amplifier input.
POSITION	Controls position of the trace. Positioning of the trace in the "ADD" Display Mode is controlled by CH 1 POSITION control only.
IDENTIFY	Deflects trace about 0.3 division for trace identification. In instruments with readout, also replaces readout with the word "IDENTIFY".

VOLTS/DIV	Selects calibrated deflection factors from 5 mv/Div to 5 V/Div; ten steps in a 1-2-5 sequence.	signal is the algebraic sum of CH 1 and CH 2 trigger.
VARIABLE (VOLTS/DIV)	Provides continuously variable uncalibrated settings between calibrated steps. Extends the deflection factor range to 12.5 V/Div or more.	CH 2—Internal trigger signal obtained from signal applied to CH 2.
GAIN Adjustment	When the VARIABLE control is pushed in, it becomes a front-panel screw-driver adjustment for calibration of deflection factor.	CH 2 POLARITY Provides means of inverting the CH 2 display. +UP—A positive-going signal at the CH 2 input connector deflects the CRT display upward.
DISPLAY MODE	Selects one of the following modes of operation: CH 1—A single-trace display of the signal applied to Channel 1. ALT—A dual-trace display of the signal applied to both channels. The channels are alternately displayed, and switching occurs at the end of each time-base sweep. ADD—Algebraically adds the signals applied to the CH 1 and CH 2 input connectors, and the algebraic sum is displayed on the CRT. The CH 2 POLARITY switch allows the display to be CH 1 + CH 2 or CH 1 - CH 2. Position of the trace in this display mode is controlled by a CH 1 POSITION control only. CHOP—A dual-trace display of the signals applied to both channels. The two channels time-share the sweep as determined by the indicator oscilloscope. CH 2—A single-trace display of the signal applied to CH 2.	INVERT—A positive-going signal at the CH 2 input connector deflects the CRT display downward.
TRIGGER SOURCE	Selects source of the trigger signal. The trigger signals provide internal triggering for the oscilloscope time-base units. CH 1—Internal triggering signal obtained from signal applied to CH 1. MODE—Internal trigger signal automatically follows DISPLAY MODE selection. In ADD or CHOP display modes, the trigger	

GENERAL OPERATING INFORMATION

Introduction

For single-trace operation, either of the two identical amplifier channels can be used independently by setting the DISPLAY MODE and TRIGGER SOURCE switches to CH 1 of CH 2 and connecting the signal to be observed to the appropriate input. In the discussions to follow, single-trace operations, using CH 1 only, apply equally to CH 2 only.

Signal Connections

In general, probes offer the most convenient means of connecting a signal to the input of the 7A18A. A 10X attenuator probe offers a high input impedance and allows the circuit under test to perform very close to normal operating conditions.

The TEKTRONIX P6053B probe, with its readout coding ring, was designed specifically for use with TEKTRONIX 7A-series amplifier units equipped with readout. The readout coding ring on the probe connects to a circuit in the amplifier unit which automatically corrects the readout displayed on the crt to the actual deflection factor at the tip of the probe being used. For probes to be used with amplifier units without readout, see the Tektronix, Inc. catalog.

Vertical Gain Check and Adjustment

To check the gain of either channel, set the VOLTS/DIV switch to 10 mV and connect 40 mV, 1 kHz signal from the oscilloscope calibrator to the input connector of the channel being checked. The vertical deflection should be exactly four divisions. If not, adjust the front-panel GAIN for exactly four divisions of deflection. The GAIN adjustment is engaged by pressing in the GAIN control knob and turning the knob with a narrow-blade screwdriver (see Front Panel Controls and Connectors). Turn the knob clockwise, then counterclock-

wise, until the GAIN control is engaged. When the GAIN control is engaged, the vertical deflection will change as the knob is turned. Turn the GAIN control knob with the screwdriver until the deflection is set to exactly four divisions, then remove the screwdriver.

Input Coupling

The Channel 1 and Channel 2 coupling (AC-GND-DC) switches allow a choice of input coupling methods. The type of display desired and the applied signal will determine the coupling to use.

The DC coupling position must be used to display the DC component of the signal. It must also be used to display AC signals below about 30 Hz (ten hertz with a 10X probe) and square waves with low-frequency components as these signals are attenuated in the AC position.

In the AC coupling position, the DC component of the signal is blocked by a capacitor in the input circuit. The AC coupling position provides the best display of signals with a DC component much larger than the AC components. The precharge feature should be used with large DC inputs. To use this feature, first set the coupling to GND. Connect the probe to the circuit and wait about two seconds for the coupling capacitor to charge. Then set the coupling to AC.

The GND position provides a ground reference at the input of the amplifier without externally grounding the input connectors. However, the signals connected to the inputs are not grounded, and the same DC load is presented to the signal source.

VOLTS/DIV and VARIABLE Controls

The amount of vertical deflection produced by a signal is determined by the signal amplitude, the attenuation factor of the probe, the setting of the VOLTS/DIV switch, and the setting of the VARIABLE control. Calibration deflection factors indicated by the settings of the VOLTS/DIV switch apply only when the VARIABLE control is in the calibrated (CAL IN) position.

The VARIABLE control provides variable, uncalibrated settings between the calibrated steps of the VOLTS/DIV switch. With the VARIABLE control fully counterclockwise and the VOLTS/DIV set to 5 volts/div the uncalibrated vertical deflection factor is extended to at least 12.5 volts/division. By applying a calibrated voltage source to the input connector, any specific deflection factor can be set within the range of the VARIABLE control.

CH 2 POLARITY Switch

The CH 2 POLARITY switch may be used to invert the displayed waveform of the signal applied to the CH 2 input. This is particularly useful in added operation of the 7A18A when differential measurements are to be made. The CH 2 POLARITY switch has two positions, +UP and INVERT. In the +UP position, the displayed waveform will have the same polarity as the applied signal and a positive dc voltage will move the crt trace up. In the INVERT position, a positive-going waveform at the CH 2 input will be displayed on the crt in inverted form and a positive dc voltage will move the trace down.

DISPLAY MODE Switch

For single-trace operation, apply the signal either to the CH 1 input of the CH 2 input and set the DISPLAY MODE switch to the corresponding position: CH 1 or CH 2.

To display a signal in one channel independently when a signal is also applied to the other channel, simply select the desired channel by setting the DISPLAY MODE switch to the appropriate CH 1 or CH 2 position.

Alternate Mode. The ALT position of the DISPLAY MODE switch produces a display which alternates between channel 1 and channel 2 with each sweep on the crt. Although the ALT mode can be used at all sweep rates, the CHOP mode provides a more satisfactory display at sweep rates below about 0.2 millisecond/division. At slow sweep rates alternate mode switching becomes visually perceptible.

Add Mode. The ADD position of the DISPLAY MODE switch can be used to display the sum or difference of two signals, for common-mode rejection to remove an undesired signal. The overall deflection factor in the ADD mode with both VOLTS/DIV switches set to the same position is the deflection factor indicated by either VOLTS/DIV switch. However, if the CH 1 and CH 2 VOLTS/DIV switches are set to different deflection factors, the resultant amplitude is difficult to determine from the crt display. In this case, the voltage amplitude of the resultant display can be determined accurately only if the amplitude of the signal applied to one channel is known. In the ADD mode, positioning of the trace is controlled by the channel 1 POSITION control only.

Chop Mode. The CHOP position of the DISPLAY MODE switch produces a display which is electronically switched between channels at approximately a 500 kHz rate (controlled by mainframe). In general, the CHOP mode provides the best display at sweep rates slower than about 0.2 millisecond/division or whenever dual-trace, non repetitive phenomena is to be displayed.

TRIGGER SOURCE Switch

CH 1. The CH 1 position of the TRIGGER SOURCE switch provides a trigger signal obtained from the signal applied to the CH 1 input connector. This provides a stable display of the signal applied to the CH 1 input connector.

CH 2. The CH 2 position of the TRIGGER SOURCE switch provides a trigger signal obtained from the signal applied to the CH 2 input connector. This provides a stable display of the signal applied to the CH 2 input connector.

MODE. In this position of the TRIGGER SOURCE switch, the trigger signal for the time-base unit is dependent on the setting of the DISPLAY MODE switch. The trigger source for each position of the DISPLAY MODE switch is as follows:

MODE	TRIGGER SIGNAL SOURCE
CH 1	Channel 1
CH 2	Channel 2
ADD	Algebraic sum of channel 1 and channel 2
CHOP	Algebraic sum of channel 1 and channel 2
ALT	Alternates between channel 1 and channel 2

Trace Identification

When the IDENTIFY button is pressed, the trace is deflected about 0.3 division to identify the 7A18A trace. This feature is particularly useful when multiple traces are displayed. In instruments with readout, also replaces deflection factor readout with the word "Identify".

BASIC APPLICATIONS

General

The following information describes the procedures and techniques for making basic measurements with a 7A18A and the associated Tektronix oscilloscope and time-base. These applications are not described in detail since each application must be adapted to the requirements of the individual measurements. This instrument can also be used for many applications not described in this manual. Contact your local Tektronix Field Office or representative for assistance in making specific measurements with this instrument.

Peak-to-Peak Voltage Measurements = (AC)

To make peak-to-peak voltage measurements, use the following procedure:

1. Apply the signal to either input connector.

2. Set the DISPLAY MODE and TRIGGER SOURCE switches to display the channel used.

3. Set the coupling switch to AC.

NOTE

For low-frequency signals below about 30 Hz use the dc position to prevent attenuation of the signal.

4. Set the VOLTS/DIV switch to display about five divisions of the waveform vertically.

5. Set the time-base Triggering controls for a stable display. Set the time-base unit to a sweep rate which displays several cycles of the waveform.

6. Turn the 7A18A POSITION control so the lower portion of the waveform coincides with one of the graticule lines below the center horizontal line, and the top of the waveform is within the viewing area. With the time-base Position control, move the display so one of the upper peaks lies near the center vertical line (see Fig. 2-2).

7. Measure the divisions of vertical deflection peak-to-peak. Check that the VARIABLE (VOLTS/DIV) control is in the CAL IN position.

NOTE

This technique can also be used to make measurements between two points on the waveform, rather than peak-to-peak.

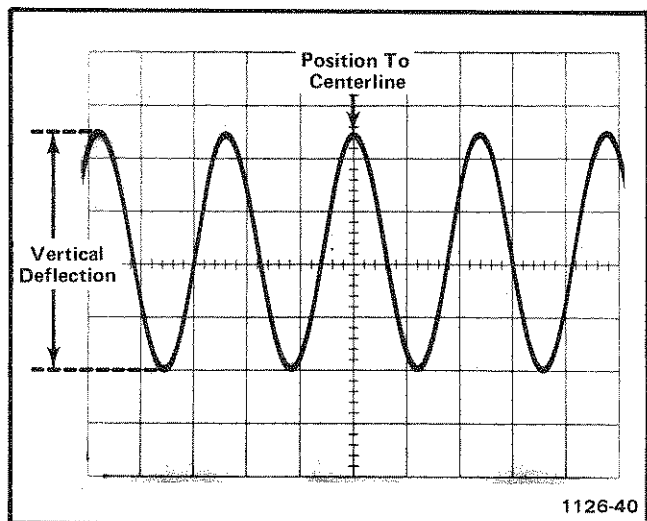

Fig. 2-2. Measuring the peak-to-peak voltage of a waveform.

8. Multiply the deflection measured in step 7 by the VOLTS/DIV switch setting. Include the attenuation factor of the probe if used.

EXAMPLE: Assume that the peak-to-peak vertical deflection is 4.5 divisions (see Fig. 2-2) using a 10X attenuator probe, and the VOLTS/DIV switch is set to 1 V.

$$\text{Volts Peak to Peak} = \text{vertical deflection (divisions)} \times \text{VOLTS/DIV setting} \times \text{probe attenuation factor}$$

Substituting the given values:

$$\text{Volts Peak-to-Peak} = 4.5 \times 1 \times 10$$

The peak-to-peak voltage is 45 V.

Instantaneous Voltage Measurements (DC)

To measure the dc level at a given point on a waveform, proceed as follows:

1. Connect the signal to either input connector.
2. Set the DISPLAY MODE and TRIGGER SOURCE switches to display the channel used.
3. Set the VOLTS/DIV switch to display about five divisions of the waveform.
4. Set the coupling switch to GND and position the trace to the bottom graticule line or other reference line. If the voltage is negative with respect to ground, position the trace to the top graticule line. Do not move the POSITION control after this reference line has been established.

NOTE

To measure a voltage level with respect to a voltage other than ground, make the following changes to step 4. Set the coupling switch to DC and apply the reference voltage to the input connector. Then position the trace to the reference line.

5. Set the coupling switch to DC. The ground reference line can be checked at any time by switching to the GND position.

6. Set the time-base Triggering controls for a stable display. Set the time-base sweep rate for an optimum display of the waveform.

7. Measure the distance in divisions between the reference line and the point on the waveform at which the dc level is to be measured. For example, in Fig. 2-3 the measurement is between the reference line and point A.

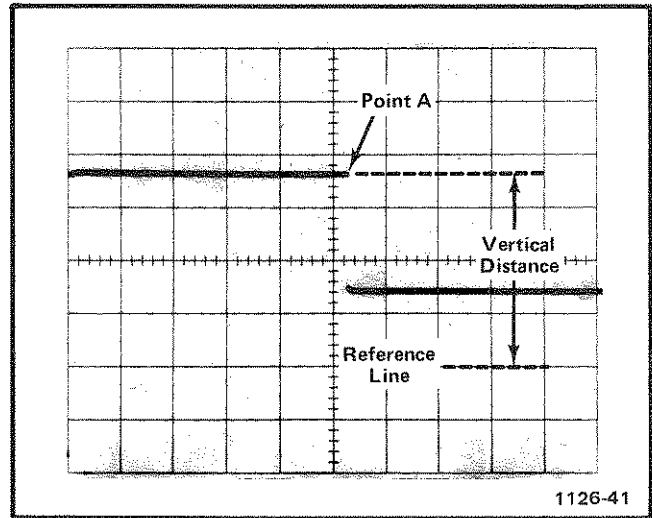

Fig. 2-3. Measuring instantaneous voltage with respect to some reference.

8. Establish the polarity of the waveform. With the CH 2 POLARITY switch in the +UP position, any point above the reference line is positive.

9. Multiply the distance measured in step 7 by the VOLTS/DIV setting. Include the attenuation factor of the probe, if used.

EXAMPLE: Assume the vertical distance measured is 3.6 divisions (see Fig. 2-3) and the waveform is above the reference line using a 10X probe with a VOLTS/DIV setting of 0.5 V.

Using the formula:

$$\text{Instantaneous Voltage} = \text{vertical distance (divisions)} \times \text{polarity} \times \text{VOLTS/DIV setting} \times \text{probe attenuation factor}$$

Substituting the given values:

$$\text{Instantaneous Voltage} = 3.6 \times +1 \times 0.5 \text{ V} \times 10$$

The instantaneous voltage is 18 V.

Comparison Measurements

In some applications it may be desirable to establish arbitrary units of measurement other than those indicated by the VOLTS/DIV switch. This is particularly useful when comparing unknown signals to a reference amplitude. One use for the comparison-measurement technique is to facilitate calibration of equipment where the desired amplitude does not produce an exact number of divisions of deflection. The adjustment will be easier and more accurate if arbitrary units of measurement are established so that the correct adjustment is indicated by an exact number of divisions of deflection. The following procedure describes how to establish arbitrary units of measure for comparison measurements.

To establish an arbitrary vertical deflection factor based upon a specific reference amplitude, proceed as follows:

1. Connect the reference signal to the input connector. Set the time-base unit sweep rate to display several cycles of the signal.

2. Set the VOLTS/DIV switch and the VARIABLE control to produce a display which is an exact number of vertical divisions in amplitude. Do not change the VARIABLE control after obtaining the desired deflection.

3. To establish an arbitrary vertical deflection factor so the amplitude of an unknown signal can be measured accurately at any setting of the VOLTS/DIV switch, the amplitude of the reference signal must be known. If it is not known, it can be measured before the VARIABLE VOLTS/DIV control is set in step 2.

4. Divide the amplitude of the reference signal (volts) by the product of the vertical deflection (divisions) established in step 2 and the setting of the VOLTS/DIV switch. This is the vertical conversion factor.

$$\text{Vertical Conversion Factor} = \frac{\text{reference signal amplitude (volts)}}{\text{vertical deflection (divisions)} \times \text{VOLTS/DIV switch setting}}$$

5. To measure the amplitude of an unknown signal, disconnect the reference signal and connect the unknown signal to the input connector. Set the VOLTS/DIV switch to a setting that provides sufficient vertical deflection to make an accurate measurement. Do not readjust the VARIABLE control.

6. Measure the vertical deflection in divisions and calculate the amplitude of the unknown signal using the following formula.

$$\text{Signal Amplitude} = \text{VOLTS/DIV setting} \times \text{vertical conversion factor} \times \text{vertical deflection (divisions)}$$

EXAMPLE: Assume a reference signal amplitude of 30 V, a VOLTS/DIV setting of 5 volts and the VARIABLE control adjusted to provide a vertical deflection of four divisions. Substituting these values in the vertical conversion factor formula (step 4):

$$\text{Vertical Conversion Factor} = \frac{30 \text{ V}}{4 \times 5 \text{ V}} = 1.5$$

Then with a VOLTS/DIV setting of 2 V, the peak-to-peak amplitude of an unknown signal which produces a vertical deflection of five divisions can be determined by using the signal amplitude formula (step 6):

$$\text{Signal Amplitude} = 2 \text{ V} \times 1.5 \times 5 = 15 \text{ volts}$$

Dual-Trace Phase Difference Measurements

Phase comparison between two signals of the same frequency can be made using the dual-trace feature of the 7A18A. This method of phase difference measurement can be used up to the frequency limit of the oscilloscope system. To make the comparison, use the following procedure:

1. Set the CH 1 and CH 2 coupling switches to the same position, depending on the type of coupling desired.

2. Set the DISPLAY MODE to ALT or CHOP. In general, CHOP is more suitable for low frequencies and ALT is more suitable for high frequencies. Set the TRIGGER SOURCE to CH 1.

3. Connect the reference signal to the CH 1 input and the comparison signal to the CH 2 input. Use coaxial cables or probes which have similar time delay characteristics to connect the signals to the input connectors.

4. If the signals are of opposite polarity, set the CH 2 POLARITY switch to invert the channel 2 display. (Signals may be of opposite polarity due to 180° phase difference; if so, take this into account in the final calculation.)

5. Set the VOLTS/DIV switches and the VARIABLE controls of the two channels so the displays are equal and about five divisions in amplitude.

6. Set the time-base unit to a sweep rate which displays about one cycle of the waveforms. Set the Triggering controls for a stable display.

7. Center the waveforms on the graticule with the 7A18A POSITION controls.

8. Adjust the time-base Variable Time/Div control until one cycle of the reference signal occupies exactly eight horizontal divisions between the second and tenth vertical lines of the graticule (see Fig. 2-4). Each division of the graticule represents 45° of the cycle ($360^\circ \div 8 \text{ divisions} = 45^\circ \text{ division}$). The sweep rate can now be stated in terms of degrees as 45°/division.

9. Measure the horizontal difference between corresponding points on the waveform.

10. Multiply the measured distance (in divisions) by 45°/division to obtain the exact amount of phase difference.

EXAMPLE: Assume a horizontal difference of 0.3 division with a sweep rate of 45°/division as shown in Fig. 2-4.

Using the formula:

$$\text{Phase Difference} = \frac{\text{horizontal difference (divisions)}}{\text{sweep rate (degrees/division)}} \times \text{sweep rate (degrees/division)}$$

Substituting the given values:

$$\text{Phase Difference} = 0.3 \times 45^\circ$$

The phase difference is 13.5°.

High Resolution Phase Measurements

More accurate dual-trace phase measurements can be made by increasing the sweep rate (without changing the Variable Time/Div control). One of the easiest ways to increase the sweep rate is with the time-base Magnifier switch. Set the Magnifier to X10 and determine the magnified sweep rate by dividing the sweep rate obtained previously by the amount of sweep magnification.

EXAMPLE: If the sweep rate is increased 10 times by the Magnifier, the magnified sweep rate is $45^\circ/\text{division} \div 10 = 4.5^\circ/\text{division}$. Fig. 2-5 shows the same signals as used in

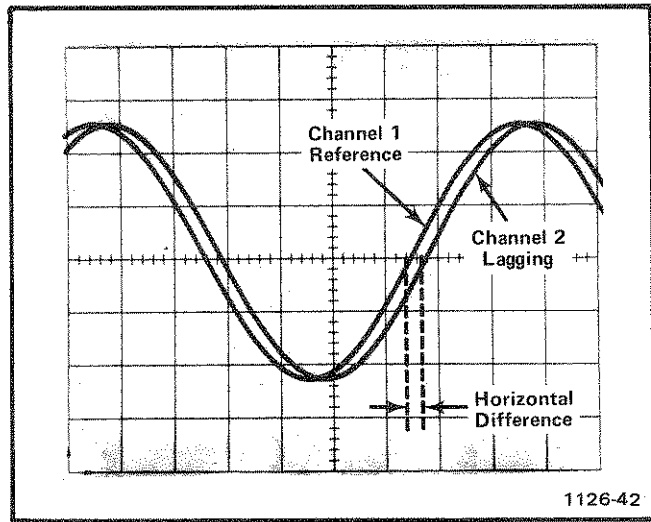

Fig. 2-4. Measuring phase difference between two signals.

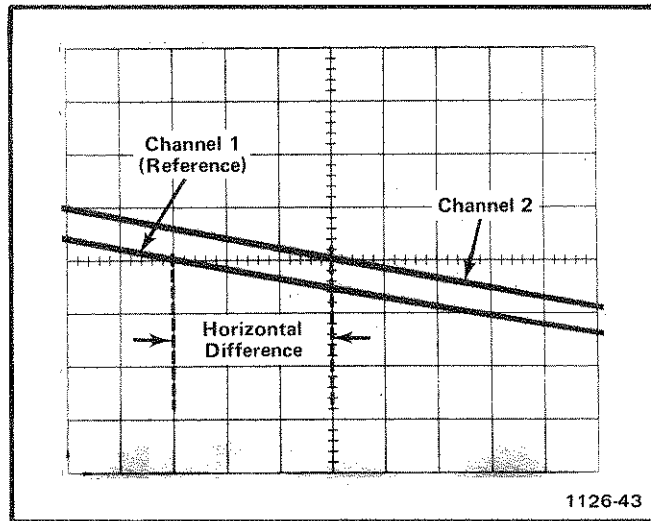

Fig. 2-5. High resolution phase measurement using time-base magnifier.

Fig. 2-4 but with the Magnifier set to X10. With a horizontal difference of 3 divisions, the phase difference is:

$$\text{Phase Difference} = \frac{\text{horizontal difference (divisions)}}{\text{magnified sweep rate (degrees/division)}} \times \text{magnified sweep rate (degrees/division)}$$

Substituting the given values:

$$\text{Phase Difference} = 3 \times 4.5^\circ$$

The phase difference is 13.5°.

Common Mode Rejection

The ADD feature of the 7A18A can be used to display signals which contain undesirable components. These unde-

erable components can be eliminated through common-mode rejection. The procedure is as follows:

1. Set the DISPLAY MODE switch to ALT or CHOP and the TRIGGER SOURCE switch to MODE.
2. Connect the signal containing both the desired and undesired information to the CH 1 input connector.
3. Connect a signal similar to the unwanted portion of the CH 1 signal to the CH 2 input connector. For example, in Fig. 2-6 a line-frequency signal is connected to Channel 2 to cancel out the line-frequency component of the Channel 1 signal.
4. Set both coupling switches to the same setting, DC or AC, depending on the applied signal.
5. Set the VOLTS/DIV switches so the signals are about equal in amplitude.
6. Set the DISPLAY MODE switch to ADD. Set the CH 2 POLARITY switch to INVERT so the common-mode signals are of opposite polarity.
7. Adjust the Channel 2 VOLTS/DIV switch and VARIABLE control for maximum cancellation of the common-mode signal. The signal which remains should be only the desired portion of the Channel 1 signal.

EXAMPLE: An example of this mode of operation is shown in Fig. 2-6. The signal applied to Channel 1 contains unwanted line frequency components (Fig. 2-6A). A corresponding line frequency signal is connected to Channel 2 (Fig. 2-6B). Fig. 2-6C shows the desired portion of the signal as displayed when common-mode rejection is used.

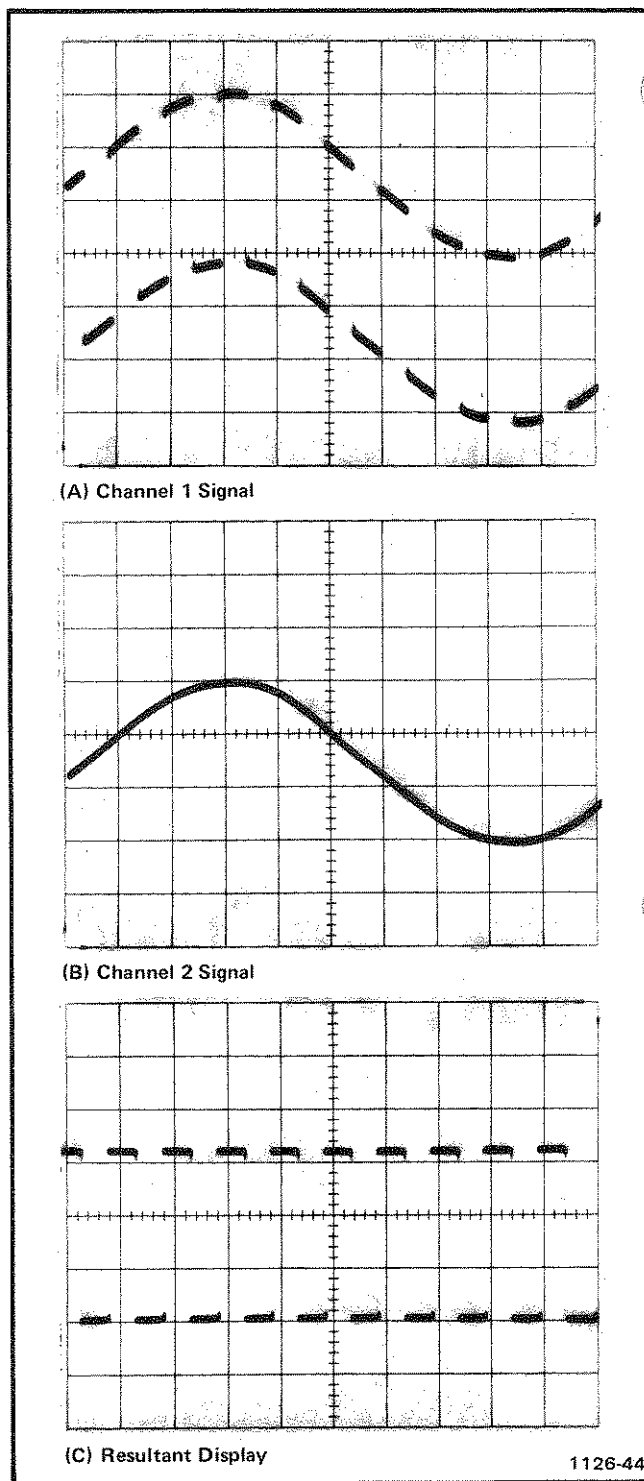

Fig. 2-6. Using the ADD mode for common-mode rejection. (A) Channel 1 signal contains desired information along with line-frequency component. (B) Channel 2 contains line frequency only. (C) Resultant CRT display using common-mode rejection.

WARNING

THE FOLLOWING SERVICING INSTRUCTIONS ARE FOR USE BY QUALIFIED PERSONNEL ONLY. TO AVOID PERSONAL INJURY, DO NOT PERFORM ANY SERVICING OTHER THAN THAT CONTAINED IN OPERATING INSTRUCTIONS UNLESS YOU ARE QUALIFIED TO DO SO. REFER TO OPERATORS SAFETY SUMMARY AND SERVICE SAFETY SUMMARY PRIOR TO PERFORMING ANY SERVICE.

1
2
3
4
5
6
7
8
9
10
11
12
13
14
15
16
17
18
19
20
21
22
23
24
25
26
27
28
29
30
31
32
33
34
35
36
37
38
39
40
41
42
43
44
45
46
47
48
49
50
51
52
53
54
55
56
57
58
59
60
61
62
63
64
65
66
67
68
69
70
71
72
73
74
75
76
77
78
79
80
81
82
83
84
85
86
87
88
89
90
91
92
93
94
95
96
97
98
99
100

CIRCUIT DESCRIPTION

Introduction

This section of the manual contains a description of the circuitry used in the 7A18A Dual-Trace Amplifier. The description begins with a discussion of the instrument using the block diagram shown in the Diagrams section. Then, each circuit is described in detail using block diagrams to show the interconnections between stages in each major circuit and the relationship of the front-panel controls to the individual stages.

Complete schematics of each circuit are given in the Diagrams section. Refer to these schematics throughout the following circuit description for electrical values and relationship.

BLOCK DIAGRAM

The following discussion is provided to aid in understanding the overall concept of the 7A18A before the individual circuits are discussed in detail. Only the basic interconnections between the individual blocks are shown on the block diagram (see Diagrams section). Each block represents a major circuit within the instrument. The number on each block refers to the schematic on which the complete circuit is found.

The signal to be displayed on the crt is applied to the input connector. The signal passes through the Input Coupling switch, where the appropriate coupling is selected, to the attenuators. The VOLTS/DIV switch selects the correct amount of attenuation and the signal is passed to the input amplifier.

The Channel 1 Input Amplifier circuit provides gain setting, variable gain control, and trace positioning. The Channel 2 Input Amplifier provides signal polarity inversion in addition to gain setting, variable gain control, and trace positioning. The outputs of these circuits are applied push-pull to the Signal and Trigger Channel Switches.

The Channel Switches select the proper signal and trigger as determined by the DISPLAY MODE and TRIGGER SOURCE switches. The signal and trigger outputs are provided to the oscilloscope via the Interface Connector.

The Readout Encoding circuit provides readout logic for the oscilloscope readout system. Data is supplied to the

mainframe readout system identifying the polarity, deflection factor, the uncalibrated symbol (when the VARIABLE control is in the outward position), and the plug-in mode. When the IDENTIFY button is pressed, the trace is deflected about 0.3 division and the deflection factor readout is replaced by the word "IDENTIFY".

DETAILED CIRCUIT DESCRIPTION ATTENUATOR

General

The Attenuator circuit determines the input coupling and the 7A18A deflection factor.

NOTE

The CH 1 and CH 2 Attenuator circuits are identical. To minimize duplication, only CH 1 is described in detail throughout this discussion.

AC-GND-DC Switch

Input signals connected to the input connector can be ac-coupled, dc-coupled, or internally disconnected. S100A is a cam-type switch; a contact-closure chart showing the operation is given on Diagram 1. The dots on this chart indicate when the associated contacts are in the position shown (open or closed). When the AC-GND-DC switch is in the DC position, the input signal is coupled directly to the Input Attenuator stage. In the AC position, the input signal passes through capacitor C10. This capacitor prevents the DC component of the signal from passing to the amplifier. The GND position opens the signal path and connects the input circuit of the amplifier to ground. This provides a ground reference without the need to disconnect the applied signal from the input connector. Resistor R102, connected across the AC-GND-DC switch, allows C10 to be precharged in the GND position so the trace remains on screen when switching to the AC position if the applied signal has a high DC level.

Input Attenuator

The effective overall deflection factor of the 7A18A is determined by the setting of the VOLTS/DIV switch, S200A. The basic deflection factor is five millivolts per division of crt deflection. To increase the basic deflection factor to the values indicated on the front panel, precision attenuators are switched into the circuit. These attenuators are hybrid devices which contain the necessary resistances and capaci-

tors. Each attenuator is replaceable as a unit. S200A is a cam-type switch and the dots on the contact-closure chart (see Diagram 1) indicate when the associated contacts are in the position shown (open or closed). In the 5 mV/Div position, input attenuation is not used; the input signal is connected directly to the input amplifier.

For switch positions above five millivolts, the attenuators are switched into the circuit singly or in pairs to produce the deflection factor indicated on the front panel. These attenuators are frequency-compensated voltage dividers. For dc and low-frequency signals, the attenuators are primarily resistance dividers and the voltage attenuation is determined by the resistance ratio in the circuit. The reactance of the capacitors in the circuit is so high at low frequencies that their effect is negligible. However, at higher frequencies, the reactance of the capacitors decreases and the attenuator becomes primarily a capacitance divider.

In addition to providing constant attenuation at all frequencies within the bandwidth of the instrument, the input attenuators are designed to maintain the same input RC characteristics (one megohm X 20 pF) for each setting of the VOLTS/DIV switch. Each attenuator contains an adjustable series capacitor to provide correct attenuation at high frequencies and an adjustable shunt capacitor to provide correct input capacitance.

CHANNEL 1 INPUT AMPLIFIER

General

The Channel 1 Input Amplifier converts the single-ended signal applied to the Channel 1 input connector to a differential (push-pull) output. Fig. 3-1 shows a detailed block diagram of the Channel 1 Input Amplifier. A schematic of this circuit is shown on Diagram 2 in the Diagrams section.

Input Source Follower

The Input Source Follower Q210A provides a high input impedance with a low-impedance drive for the following stage. R210 limits the current drive to the gate of Q210A. Dual-diode CR210 provides circuit protection by limiting the voltage swing at the gate of Q210A. Dual-diode CR210 provides circuit protection by limiting the voltage swing at the gate of Q210A to about 15 volts. Q210B provides a constant current source for Q210A. Q210A and Q210B are encapsulated in the same case so that Q210B temperature-compensates the circuit.

Paraphase Cascode Amplifier

Paraphase amplifier Q220-Q320, in conjunction with Q225-Q325, forms a cascode amplifier. Q220-Q320 convert

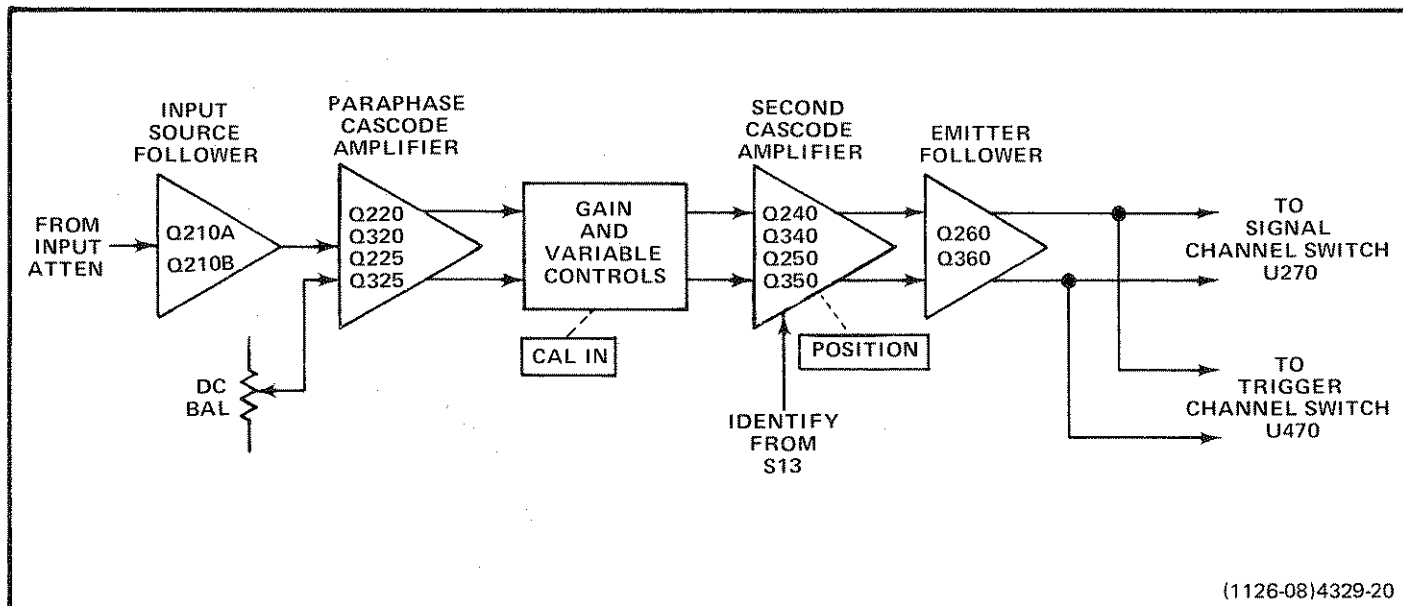

Fig. 3-1. Channel 1 Input Amplifier detailed block diagram.

the single-ended input signal to a differential output signal. Diodes CR220-CR221 hold the voltage level at the base of Q220 close to ground to limit the voltage swing to about ± 0.6 volt. Common-base connected Q225-Q325 provide isolation between the paraphase amplifier and the GAIN controls. Adjustment R321, varies the base level of Q320 to provide the same voltage levels at the collectors of Q225 and Q325. This prevents a zero-volt reference trace from changing position when varying the VARIABLE controls.

The front panel gain adjustment and the variable gain control circuits consists of Q245, Q345, U675, and associated components. Q345 acts as a resistor with its value determined by the position of the wiper of R663 or R668. Since Q345 is in parallel with R242, and R342, it shunts part of the signal current away from the common base stages of Q250 and Q350, thereby reducing the gain of the amplifier.

When S667 is in the calibrated position, the wiper voltage of R668 is applied to the non-inverting input of U675B. U675B controls the resistance of Q245 so that the junction of R677 and R681 is equal to the voltage selected by the wiper of R668. U675B and Q245 sets the potential across R676 and R677 equal to the divider action of R665 and R666, along with the divider action of R668.

Since R676-R677 approximate the emitter impedance of Q250-Q350 and the gates of Q345 and Q245 are common, the resistance of Q345 will equal the resistance of Q245, and thus shunt a proportional amount of signal current, equal to the ratio of R681's current flowing in Q245, away from the signal path.

U675A holds the junction of R676-R677 at the common mode voltage level of the drain and source of Q345. Since equal currents flow in R676-R677 and their junction is tied to the common mode point, the push-pull condition at the drain and source of Q345 is simulated. Either source to drain or drain to source current flow can occur in Q345, depending upon the instantaneous polarity of push-pull signals.

When S667 is in the variable position circuit, operation is the same, except R663 is used to select the gain of the amplifier. The gain position has approximately a 1.5 to 1 range whereas the variable has a 3.0 to 1 range.

Channel 2 works in an identical manner, with Q445 and Q545 in place of Q245 and Q345.

Second Cascode Amplifier

The Second Cascode Amplifier stage provides a signal gain of approximately two. This stage includes the POSITION control and, the trace IDENTIFY circuit. The emitters of common-base connected Q250-Q350 provide a low-impedance point for injection of the POSITION control and IDENTIFY switch currents. Position of the trace is determined by the setting of the POSITION control, R11. This control changes the current drive to Q250-Q350. Since the emitters are a very low-impedance point in the circuit, there is negligible voltage change at these points. However, the change in current from the POSITION control produces a resultant dc voltage difference at the collectors to change the position of the trace. Trace identification is accomplished by inserting resistor R357 from ground through CR256 to the junction of R11-R256. This results in a slight increase in the emitter current of Q250 to cause the trace to move. This aids in identifying the channel 1 trace when multiple traces are displayed.

The network C246-C345-C245-R246-R345-R245 provides high frequency compensation. R245-C245 in this network provide high-frequency response adjustment for this stage.

Emitter Follower

Emitter Follower stage Q260-Q360 provides a low output impedance to drive the Signal and Trigger Channel Switches, U270-U470. This stage also provides isolation between the Second Cascode Amplifier and U270-U470.

CHANNEL 2 INPUT AMPLIFIER

General

The Channel 2 Input Amplifier circuit is basically the same as the Channel 1 Input Amplifier circuit. Only the differences between the two circuits are described here. Portions of this circuit not described in the following description operate in the same manner as for the Channel 1 Input Amplifier circuit (corresponding circuit numbers assigned in the 400 - 599 range). Fig. 3-2 shows a detailed block diagram of the Channel 2 Input Amplifier circuit. A schematic of this circuit is shown on Diagram 3 in the Diagrams section.

Paraphase Cascode Amplifier

The Paraphase Cascode Amplifier for Channel 2 consists of Q420, Q520, Q425, Q525, Q426, and Q526. In addition to the functions described under Channel 1 Input Amplifier, the Channel 2 Paraphase Cascode Amplifier stage provides

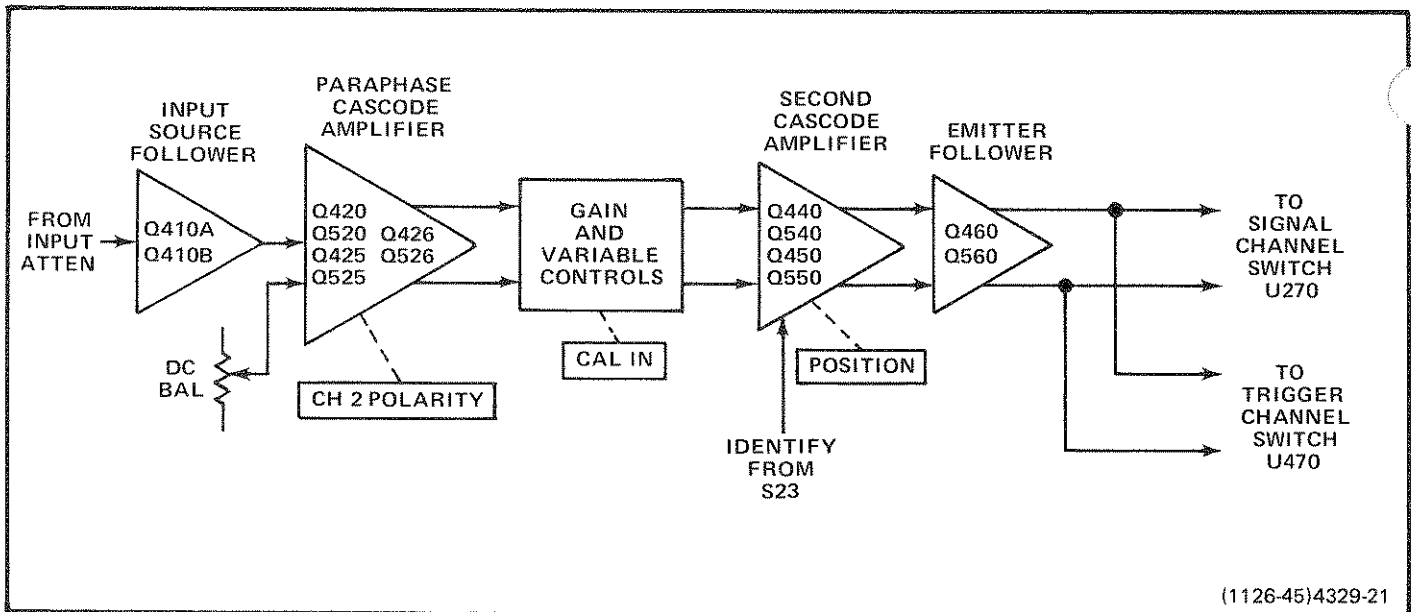

Fig. 3-2. Channel 2 Input Amplifier detailed block diagram.

a means of inverting the displayed signal. With the CH 2 POLARITY switch set to +UP, Q426 and Q526 are biased on and the signal is passed to the Second Cascode Amplifier stage as for the Channel 1 Input Amplifier. With the CH 2 POLARITY switch set to INVERT, Q426 and Q526 are biased off and Q425-Q525 are turned on to provide signal inversion.

Second Cascode Amplifier

The Second Cascode Amplifier consists of Q440, Q540, Q450, and Q550. Position of the trace is set by the POSITION control, R21 or by network R455-R555 as determined by the DISPLAY MODE switch. In any DISPLAY MODE switch position other than ADD, +50 volts is applied to the center arm of the POSITION control through R549. The POSITION control varies the current drive to the emitters of Q450-Q550. Since the emitters are a very low-impedance point in the circuit, there is negligible voltage change at these points. However, the change in current from the POSITION control produces a resultant dc voltage difference at the collectors to change the position of the trace. When the DISPLAY MODE switch is in the ADD position, +50 volts is applied to the junction of resistors R455-R555 through R549 to balance the current drive to the emitters of Q450-Q550. This results in a fixed zero volts (approximately) difference between the collectors. Since +50 volts is not applied to the POSITION control in the ADD position of the DISPLAY MODE switch, the control setting has no effect on the circuit operation.

CHANNEL SWITCHES

General

The Channel Switches circuit provides Signal and Trigger outputs to the oscilloscope via the Interface Connector as determined by the DISPLAY MODE and TRIGGER SOURCE switches. A schematic of this circuit is given on Diagram, 4 in the Diagrams section.

Signal Channel Switch

The Signal Channel Switch stage consists of integrated circuit U270 and its external components. This stage selects one, or mixes two input analog signals in response to inputs from the DISPLAY MODE switch. The Signal Channel Switch stage determines which input (CH 1 or CH 2) provides the signal to the oscilloscope as controlled by the DISPLAY MODE switch setting. Resistors R276-R277 and R376-R377 set the current gain for each channel. Networks C274-R274-C275-R275 and C374-R374-C375-R375 provide high-frequency compensation for each channel. C275 and C375 in these networks are high-frequency compensation adjustments.

Figure 3-3 shows the U270 input combinations for each position of the DISPLAY MODE switch. When the level at pin 14 is LO the output of U270 is determined by the level at pin 4. With the level at pin 14 HI and the level at pin 4 LO,

DISPLAY MODE SELECTED	U270	
	Pin 4	Pin 14
CH 1	LO	LO
ALT	**	LO
ADD	LO	HI
CHOP	*	LO
CH 2	HI	LO

*Level is switched between the HI-level and LO-level at an approximate 0.5 megahertz rate.

**Level is switched between the HI-level and LO-level at a rate determined by the setting of the time-base unit sweep rate.

1126-46

Fig. 3-3. U270 input combinations for DISPLAY MODE selection.

the signals from both channel 1 and channel 2 are passed to the Signal Output stage. This condition occurs only when the DISPLAY MODE switch is set to ADD. In this operating mode the signal output is the algebraic sum of channel 1 and channel 2 signals and the resultant signal determines the mainframe deflection.

Trigger Channel Switching

The Trigger Channel Switch J470 is identical to the Signal Channel Switch. This stage determines which input (CH 1 or CH 2) provides the trigger signal for internal triggering of the time-base unit. The selection of the trigger signal is controlled by inputs from the TRIGGER SOURCE switch. Resistors R476-R477 and R576-R577 set the current gain for each channel. Networks C474-R474-C475-R475 and C574-R574-C575-R575 provide high-frequency compensation for each channel.

An input/output table for this stage is shown in Fig. 3-4. When the level at pin 14 is LO, the output of U470 is determined by the level at pin 4. With the level at pin 14 HI and the level at pin 4 LO, the Channel 1 and Channel 2 triggers are added algebraically.

Signal and Trigger Output

The Signal Output stage, Q280-Q380, and the Trigger Output stage, Q480-Q580, are similar. Each stage consists of a pair of common-base connected transistors which provide the dc level shifting necessary to drive the mainframe circuits.

INPUT		OUTPUT		
Display Mode Switch	Trigger Source Switch	U470 Pins		Trigger Signal Source
		4	14	
CH 1	CH 1	LO	LO	CH 1
	MODE	LO	LO	CH 1
	CH 2	HI	LO	CH 2
ALT	CH 1	LO	LO	CH 1
	MODE	HI-LO	LO	Alternates between CH 1 and CH 2
	CH 2	HI	LO	CH 2
ADD	CH 1	LO	LO	CH 1
	MODE	LO	HI	CH 1 and CH 2 added
	CH 2	HI	LO	CH 2
CHOP	CH 1	LO	LO	CH 1
	MODE	LO	HI	CH 1 and CH 2 added
	CH 2	HI	LO	CH 2
CH 2	CH 1	LO	LO	CH 1
	MODE	HI	LO	CH 2
	CH 2	HI	LO	CH 2

1126-47

Fig. 3-4. Input/Output combinations for DISPLAY MODE and TRIGGER SOURCE switch selections.

DISPLAY MODE AND TRIGGER SWITCHING

General

The Display Mode and Trigger Switching circuit determines which input signal (Channel 1 or Channel 2) provides the Signal and Trigger outputs to the mainframe as selected by the DISPLAY MODE and TRIGGER SOURCE switches. This circuit also provides plug-in mode information to the mainframe chop blanking circuit, and readout control information for proper crt display.

DISPLAY MODE Switch

The DISPLAY MODE switch provides logic level outputs to the Signal Channel Switch stage (U270, Channel Switches Diagram 4). A table of the outputs for each position of the DISPLAY MODE switch is shown in Figure 3-3.

TRIGGER SOURCE Switch

The TRIGGER SOURCE switch provides logic level outputs to the Trigger Channel Switch (U470, Channel Switches Diagram 4). A table of the outputs for each switch position is shown in Figure 3-4.

CONNECTORS AND READOUT

Connectors

All the connections made to the mainframe by the 7A18A are shown on the Connectors schematic, Diagram 6. Also shown are the power supply decoupling components.

Readout Encoding

The Readout Encoding circuit consists of switching resistors and probe sensing stage Q620 and is shown on Diagram 5. This circuit encodes the Channel 1 and 2, Row and Column output lines for readout of deflection factor, uncalibrated deflection factor (VARIABLE) information, and signal inversion (Channel 2 only). Data is encoded on these output lines by switching resistors between them and the time-slot input lines, or by adding current through Q620.

R647-CR647 are switched between time-slot three (TS-3) and Column output line when the CAL IN switch is in the uncal position. This results in the symbol > (greater than) being displayed preceding the deflection factor readout. R648 (Channel 2 only) is switched between TS-2 and the Column output line when the CH 2 POLARITY switch is in the INVERT position. This results in the symbol ↓ (inverted) being displayed preceding the deflection factor readout.

Switching resistors are used to indicate the setting of the VOLTS/DIV switch to the mainframe readout system. The VOLTS/DIV switch is a cam-type switch. The dots on the contact-closure chart (see Diagram 5) indicate when the associated contacts are closed. R633, R634, and R635 select the number 1, 2, or 5 depending on the resistor combination that is switched in. R647 selects the m (milli-) prefix and R639 selects the symbol V (volts) in the 5 mV through .5 V (50 mV) positions of the VOLTS/DIV switch. R638 selects the symbol V in the 1, 2, and 5 V positions. R630, R631, and the output of the probe sensing stage (Q620) select the decimal point (number of zeroes) again depending on the resistor combination switched in by the VOLTS/DIV switch.

Probe sensing stage Q620 identifies the attenuation factor of the probe connected to the input connector by sensing the amount of current flowing from the current sink

through the probe coding resistance. The output of this circuit corrects the mainframe readout system to include the probe attenuation factor. The third contact of the input connector provides the input to the probe sensing stage from the probe coding resistance (coded probes only; see Operating Instructions). The third contact is also used for the IDENTIFY input. The coding resistor forms a voltage divider with R621 through CR621 to the -15 V supply. The resultant voltage sets the bias on Q620 and determines, along with emitter resistor R622, the collector current. When the -15 volt time-slot pulse is applied to Interface Connector B33, Q620 is interrogated and its collector current is added to the column current output through Interface Connector A37.

With a 1X probe (or no probe) connected to the input connector, Q620 is turned off. The deflection factor readout is determined by the VOLTS/DIV switch position. With a 10X probe connected, the bias on Q620 will allow 100 microamperes of collector current to flow. This increases the deflection factor readout by a factor of 10.

The IDENTIFY button (S13 or S23 on Diagram 1) does two things when pressed:

1. It causes the trace representing the appropriate channel of the 7A18A to move about 0.3 division (see the discussion on the Channel 1 or Channel 2 Input Amplifier).

2. Forward biases CR621 and Q620 to result in a sufficient amount of collector current which, when added to the column current output, replaces the deflection factor readout with the word "IDENTIFY".

These two actions aid in identifying the 7A18A trace when multiple traces are displayed. When the IDENTIFY button is released, the deflection factor readout and trace position are restored.

For further information on the operation of the readout system, see the oscilloscope instruction manual.

PERFORMANCE CHECK AND ADJUSTMENT

Recalibration Interval

To assure instrument accuracy, check the calibration of the 7A18A every 1000 hours of operation, or every six months if used infrequently. Before complete calibration, thoroughly clean and inspect this instrument as outlined in the Maintenance section.

Tektronix Field Service

Tektronix, Inc., provides complete instrument repair and recalibration at local Field Service Centers and the Factory Service Center. Contact your local Tektronix Field Office or representative for further information.

Using This Procedure

General. This section provides several features to facilitate checking or adjusting the 7A18A. These are:

Index. To aid in locating a step in the Performance Check or Adjustment procedure, an index is given preceding Part I—Performance Check and Part II—Adjustment procedure.

Performance Check. The performance of this instrument can be checked without removing the side shields or making internal adjustments by performing only Part I—Performance Check. This procedure checks the instrument against the tolerances listed in the Performance Requirement column of Section 1. In addition, a cross-reference is provided to the step in Part II—Adjustment which will return the instrument to correct calibration. In most cases, the adjustment step can be performed without changing control settings or equipment connections.

Adjustment Procedure. To return this instrument to correct calibration with the minimum number of steps, perform only Part II—Adjustment. The Adjustment procedure gives the recommended calibration procedure for all circuits in this instrument.

Complete Performance Check/Adjustment. To completely check and adjust all parts of this instrument, perform both Parts I and II. Start the complete procedure by performing the Adjustment procedure and follow this with the Performance Check. This method will assure that the instrument is both correctly adjusted and performing within all Performance Requirements as given in Section 1.

TEST EQUIPMENT REQUIRED

General

The following test equipment and accessories, or its equivalent, is required for complete calibration of the 7A18A. Specifications given for the test equipment are the minimum necessary for accurate calibration. Therefore, some of the specifications listed here may be somewhat less precise than the actual performance capabilities of the test equipment. All test equipment is assumed to be correctly calibrated and operating within the listed specifications.

The Performance Check and Adjustment procedures are based on this recommended equipment. If other equipment is substituted, control settings or calibration setup may need to be altered to meet the requirements of the equipment used. Detailed operating instructions for the test equipment are not given in this procedure. Refer to the instruction manual for the test equipment if more information is needed.

Calibration Equipment Alternatives

All of the test equipment is required to completely check and adjust this instrument. However, some of the items used only for the Performance Check can be deleted without compromising the instrument's measurement capabilities. For example, the low-frequency constant-amplitude signal generator is used only in the Performance Check and may be deleted if the user does not desire to check the lower frequency response or trigger source operation. Equipment used only for the Performance Check procedure is indicated by note 1; items required only for the Adjustment procedure are indicated by note 2.

Table 4-1
Test Equipment

Description	Minimum Specifications	Purpose	Example of Applicable Test Equipment
Oscilloscope mainframe	TEKTRONIX 7000-Series with 2 horizontal plug-in compartments; bandwidth 75 MHz	Provides a display for unit under test	TEKTRONIX 7603 Oscilloscope
Time-Base plug-in unit	TEKTRONIX 7B-Series sweep unit	Provides horizontal sweep for oscilloscope system	TEKTRONIX 7B50A Time Base
Amplitude calibrator	Output: signal, 1 kHz square wave; amplitude, 20 mV to 20 V; accuracy, within 0.25%	Vertical gain checks and adjustments	TEKTRONIX PG 506 Pulse Generator ³
Medium-frequency sine-wave generator ¹	Frequency, 50 to 75 MHz output amplitude, 50 mV to 200 mV into 50 Ω	Common mode rejection and bandwidth checks	TEKTRONIX SG 503 Signal Generator ³
Low-frequency signal generator ¹	Frequency, 2 Hz to 10 kHz; output amplitude, 10 mV to 400 mV p-p	Triggering check	TEKTRONIX FG 503 Function Generator ³
Square-wave generator ²	Output capabilities: 12 V into 50 Ω with a risetime of at least 12 ns and a frequency of approximately 1 kHz; 500 mV into 50 Ω with a risetime of at least 1 ns to 100 kHz	Input and low-frequency compensation adjustments	TEKTRONIX PG 506 Pulse Generator ³
Plug-in Extender	Provides access to 7A18A adjustments	Used for aberrations check	Tektronix Calibration Fixture 067-0589-00
Accessories BNC cable	Connectors, BNC; length, 42 inches	Used throughout procedure	Tektronix Part Number 012-0057-01
10X attenuator	Connectors, BNC; impedance, 50 Ω	High frequency compensation	Tektronix Part Number 011-0059-02
RC normalizer	Time constant, 1 M Ω x 20 pF; connector, BNC; attenuation, 2X	Input compensation	Tektronix Part Number 067-0538-00
Termination (through line)	Impedance, 50 Ω ; connectors, GR to BNC male	Used throughout procedure	Tektronix Part Number 017-0083-00
Dual-Input cable	Connectors, BNC; matched signal transfer to each input	Common mode rejection	Tektronix Calibration Fixture 067-0525-01

Table 4-1 (cont)

Description	Minimum Specifications	Purpose	Example of Applicable Test Equipment
Adjustment tools Screwdriver	Three-inch shaft, 3/32-inch bit	Used for potentiometer adjustments	Xcelite R-3323
Low-capacitance screwdriver	1 1/2-inch shaft	Used for variable capacitor adjustments	Tektronix Part Number 003-0000-00
Tuning tool	Handle with inserts	Used for capacitance and attenuator adjustments	Tektronix Part Numbers 003-0307-00, 003-0334-00, and 003-0497-00

¹Required only for Performance Check.

²Required only for Adjustment Procedure.

³Requires TM 500-Series Power Module.

PART I—PERFORMANCE CHECK

Introduction

The following procedure checks the performance of the 7A18A without removing the covers or making internal adjustments. All tolerances given in this procedure are based on Section 1 of this manual:

Preliminary Control Settings

Set the Indicator Oscilloscope and 7A18A controls as follows (for both Performance Check and Adjustment procedure):

Indicator Oscilloscope

Intensity	Midrange
Focus	Adjust for well-defined display
Graticule Illum	As desired
Calibrator	40 mV
Rate	1 kHz
Vert Mode	Left
Trig Source	Left Vert

7A18A

DISPLAY MODE	CH 1
TRIGGER SOURCE	MODE
CH 2 POLARITY	+UP

CH 1 and CH 2

POSITION	Midrange
VOLTS/DIV	10 mV
AC-GND-DC	DC

Index to Part I—Performance Check

	Page
1. Check Channel 1 and 2 GAIN	4-4
2. Check Channel 1 and 2 Deflection Factor Accuracy	4-5
3. Check Channel 1 and 2 VARIABLE (VOLTS/DIV) Range	4-5
4. Check Channel 1 and 2 Trace IDENTIFY	4-5
5. Check Channel 1 and 2 Upper Bandwidth	4-5
6. Check Channel 1 and 2 Lower Frequency Response	4-6
7. Check Channel Isolation	4-6
8. Check Common-Mode Rejection Ratio	4-6

4-4

Index to Part I—Performance Check (cont)

	Page
9. Check Alternate Operation	4-7
10. Check Chopped Operation	4-7
11. Check Trigger Source Operation	4-7

Preliminary Procedure for Performance Check

NOTE

The performance of this instrument can be checked at any temperature within the 0°C to +50°C range unless stated otherwise.

1. Install the 7A18A in the left vertical plug-in compartment of the Indicator Oscilloscope.
2. Connect the Indicator Oscilloscope to a power source which meets the frequency and voltage requirements of the oscilloscope power supply.
3. Turn the Indicator Oscilloscope power on. Allow at least twenty minutes warmup for checking the 7A18A to the given accuracy.
4. Set the controls as given under Preliminary Control Settings.

NOTE

The checks titled Channel 1 and 2 apply equally to both channels. Perform the check on the channel selected by the DISPLAY MODE switch.

1. Check Channel 1 and 2 GAIN

- a. Connect the standard amplitude calibrator output to the CH 1 and CH 2 input connectors with the 42-inch BNC cable and dual-input coupler.
- b. Set the standard amplitude calibrator for a 50-millivolt square-wave output.
- c. CHECK—CRT display for a five-division display.

d. If necessary, adjust the front-panel GAIN control for exactly five divisions of vertical deflection. To adjust, press in the GAIN knob with screwdriver and turn until the GAIN control is engaged.

e. Set the DISPLAY MODE switch to CH 2 and repeat parts c and d of this step for Channel 2.

2. Check Channel 1 and 2 Deflection Factor Accuracy

a. Set the Channel 1 AC-GND-DC switch to GND.

b. CHECK—Using the VOLTS/DIV and standard amplitude calibrator settings given in Table 4-2, check vertical deflection within 2% in each position of the CH 2 VOLTS/DIV switch.

c. Change the following control settings:

DISPLAY MODE CH 1
 CH 1 AC-GND-DC DC
 CH 2 AC-GND-DC GND

d. Repeat part b of this step for Channel 1.

Table 4-2
Vertical Deflection Accuracy

VOLTS/DIV Switch Setting	Standard Amplitude Calibrator Output	Vertical Deflection in Divisions	Maximum Error for ±2% Accuracy (divisions)
5 V	20 mV	4	±0.08
10 mV	50 mV	5	Set in step 1
20 mV	0.1 V	5	±0.1
50 mV	0.2 V	4	±0.08
.1 V	0.5 V	5	±0.1
.2 V	1 V	5	±0.1
5 V	2 V	4	±0.08
5 V	5 V	5	±0.1
2 V	10 V	5	±0.1
5 V	20 V	4	±0.08

3. Check Channel 1 and 2 VARIABLE (VOLTS/DIV) Range

a. Set the Channel 1 and 2 VOLTS/DIV switches to 10 mV and the standard amplitude calibrator for a 50-millivolt output.

b. Press and release the VARIABLE control to its outward position.

c. CHECK—With the VARIABLE control fully counter-clockwise, check for two divisions or less of deflection.

d. Return the VARIABLE control to the CAL IN position.

e. Change the following control settings:

DISPLAY MODE CH 2
 CH 2 AC-GND-DC DC

f. Repeat parts b, c, and d of this step for Channel 2.

4. Check Channel 1 and 2 Trace IDENTIFY

a. Center the crt display vertically with the 7A18A POSITION control.

b. CHECK—Press the IDENTIFY button and check that the trace moves upward.

c. Set the DISPLAY MODE switch to CH 1 and repeat parts a and b of this step for Channel 1.

d. Disconnect all test equipment.

5. Check Channel 1 and 2 Upper Bandwidth

a. Connect the medium-frequency constant-amplitude sine-wave generator to the 7A18A CH 1 input connector with the 42-inch BNC cable and in-line 50 ohm BNC termination.

b. Set the medium-frequency generator for an eight-division display (80 millivolts) at the 50-kilohertz reference frequency.

c. Increase the generator frequency until the display amplitude decreases to 5.6 divisions.

d. CHECK—Generator output frequency; must be at least 75 megahertz.

e. Disconnect the generator output from the CH 1 input connector and connect it to the CH 2 input connector.

f. Set the DISPLAY MODE switch to CH 2.

g. Repeat parts b, c, and d of this step for Channel 2.

h. CALIBRATION—See step 5 of the Adjustment procedure.

i. Disconnect all test equipment.

6. Check Channel 1 and 2 Lower Frequency Response

a. Change the following control settings:

CH 1 and CH 2	
VOLTS/DIV	5 mV
AC-GND-DC	AC

b. Set the time-base unit for a free-running sweep at a rate of two milliseconds/division.

c. Connect the low-frequency constant-amplitude sine-wave generator to the CH 2 input connector with the 42-inch BNC cable, 10X BNC attenuator, and 50-ohm BNC termination.

d. Set the low-frequency generator for a six-division display (30 millivolts) at 10 kilohertz.

e. Decrease the generator frequency until the display amplitude decreases to 4.2 divisions.

f. CHECK—Generator frequency; must be 10 hertz or less.

g. Disconnect the low-frequency generator from the CH 2 input connector and connect it to the CH 1 input connector.

h. Set the DISPLAY MODE switch to CH 1.

i. Repeat parts d through f of this step for Channel 1.

j. Disconnect all test equipment.

7. Check Channel Isolation

a. Change the following control settings:

CH 1 and CH 2	DC
AC-GND-DC	
CH 1 VOLTS/DIV	.1 V
CH 2 VOLTS/DIV	10 mV

b. Connect the medium-frequency generator to the CH 1 input connector with the 42-inch BNC cable and in-line 50-ohm BNC termination.

c. Set the generator for a two-division display (200 millivolts) at 50 megahertz.

d. Change the following control settings:

DISPLAY MODE	CH 2
CH 1 VOLTS/DIV	10 mV

e. CHECK—Crt display for 0.4 division or less deflection (channel isolation display ratio 50:1 or better).

f. Disconnect the termination from Channel 1 and connect it to the CH 2 input connector.

g. Set the CH 2 VOLTS/DIV switch to .1 V.

h. Set the generator for a two-division display (200 millivolts) at 50 megahertz.

i. Change the following control settings:

CH 1 VOLTS/DIV	10 mV
DISPLAY MODE	CH 1
CH 2 VOLTS/DIV	10 mV

j. CHECK—Crt display for 0.4 division or less deflection.

k. Disconnect all test equipment.

8. Check Common-Mode Rejection Ratio

a. Change the following control settings:

CH 1 and CH 2 VOLTS/DIV	10 mV
-------------------------	-------

b. Connect the medium-frequency generator to the CH 1 and CH 2 input connectors with the 42-inch BNC cable, in-line 50-ohm BNC termination, and the dual-input coupler.

c. Set the constant-amplitude generator for an eight-division display (80 millivolts) at 50 megahertz.

d. Change the following control settings:

DISPLAY MODE	ADD
CH 2 POLARITY	INVERT

e. CHECK—Crt display for 0.8 division or less deflection (common-mode rejection ratio 10:1 or better).

f. Disconnect all test equipment.

9. Check Alternate Operation

a. Set the DISPLAY MODE switch to ALT.

b. Position the trace about two divisions apart.

c. Turn the time-base unit time/division switch throughout its range.

d. CHECK—Trace alternation between Channel 1 and 2 at all sweep rates. At faster sweep rates, alternation will not be apparent; instead display appears as two traces on the screen.

10. Check Chopped Operation

a. Set the DISPLAY MODE switch to CHOP.

b. CHECK—Crt display for two traces.

11. Check Trigger Source Operation

a. Change the following control settings:

DISPLAY MODE	ALT
TRIGGER SOURCE	CH 1

b. Connect the Indicator Oscilloscope Cal Out connector to the CH 1 input connector with the 18-inch BNC cable.

c. Set the time-base unit for a triggered display at a sweep rate of 0.5 millisecond/division.

d. Connect the low-frequency generator to the CH 2 input connector with the 42-inch BNC cable.

e. Set the generator for a two-division (40 millivolts) one-kilohertz signal.

f. CHECK—Crt display for square wave and sine wave; square wave only is stable.

g. Set the TRIGGER SOURCE switch to MODE.

h. CHECK—Crt display; square wave and sine wave are both stable.

i. Set the TRIGGER SOURCE switch to CH 2.

j. CHECK—Crt display; sine wave only is stable.

k. Disconnect all test equipment.

This completes the Performance Check procedure for the 7A18A. If the instrument has met all tolerances given in this procedure, it is correctly calibrated and within the specified limits.

PART II—ADJUSTMENT

Introduction

The following procedure returns the 7A18A to correct calibration. All limits and tolerances given in this procedure are calibration guides, and should not be interpreted as instrument specifications except as listed in the Performance Requirement column of Section 1. The actual operation of the instrument may exceed the given limits or tolerances if the instrument meets the Performance Requirements as checked in Part I—Performance Check of this section.

Index to Part II—Adjustment

	Page
1. Adjust Channel 1 and 2 Dc Balance	4-8
2. Adjust Channel 1 and 2 GAIN	4-9
3. Adjust Channel 1 and 2 Input Capacitance	4-9
4. Adjust Channel 1 and 2 Attenuator Compensation	4-10
5. Adjust Channel 1 and 2 High-Frequency Compensation	4-11

Preliminary Procedure For Adjustment

NOTE

This instrument should be adjusted at an ambient temperature of 25° C ± 5° for best overall accuracy.

1. Remove the left side shield from the 7A18A and the left side panel from the Indicator Oscilloscope.
2. Install the 7A18A in the left vertical plug-in compartment of the Indicator Oscilloscope.
3. Connect the Indicator Oscilloscope to a power source which meets the frequency and voltage requirements of the oscilloscope power supply.
4. Turn the Indicator Oscilloscope power on. Allow at least twenty minutes warmup before proceeding.
5. Set the controls as given under Preliminary Control Settings.
6. Adjust the Focus and Astigmatism as necessary to obtain a well-defined display.

NOTE

Titles for external controls of this instrument are capitalized in this procedure (e.g., VOLTS/DIV). Internal adjustments are initial capitalized only (e.g., DC Balance).

Location of Adjustments

The locations of the 7A18A adjustments are shown in Fig. 4-1.

1. Adjust Channel 1 and 2 DC Balance

- a. Position the trace to the center horizontal line with the CH 1 POSITION control.
- b. Push and release the CH 1 VARIABLE (VOLTS/DIV) control to its outward position.
- c. CHECK—Turn the VARIABLE control from fully counterclockwise to fully clockwise. Trace should not move more than 0.5 division vertically.
- d. ADJUST—Channel 1 DC Balance, R321 for minimum trace shift as the CH 1 VARIABLE control is rotated from fully counterclockwise to fully clockwise. See Fig. 4-1 for adjustment location.
- e. Set the CH 1 VARIABLE control to the CAL IN position.
- f. Set the DISPLAY MODE switch to CH 2.
- g. Position the trace to the center horizontal line with the CH 2 POSITION control.
- h. ADJUST—DC BAL, R521, for no trace shift while switching CH 2 POLARITY switch from +UP to INVERT. See Fig. 4-1 for adjustment location.
- i. ADJUST—CH 2 VARIABLE DC BAL, R544, for minimum trace shift as the CH 2 VARIABLE control is rotated from fully counterclockwise to fully clockwise. See Fig. 4-1 for adjustment location.
- j. Set the CH 2 VARIABLE control to the CAL IN position.

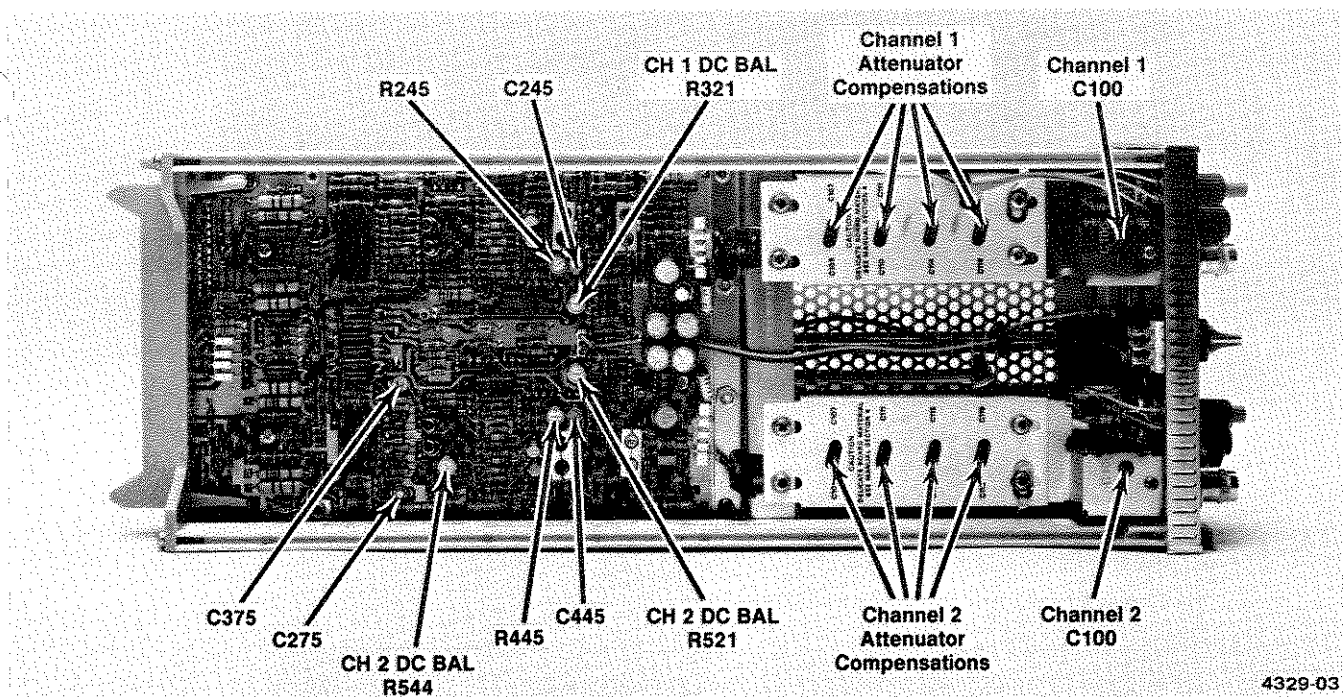

Fig. 4-1. Locations of adjustments used in this procedure.

2. Adjust Channel 1 and 2 GAIN

a. Connect the standard amplitude calibrator to the CH 2 input connector with the 42-inch BNC cable.

b. Set the standard amplitude calibrator for 50-millivolt square-wave output.

c. Position the display to the center of the graticule with the CH 2 POSITION control.

d. CHECK—CRT display for exactly five divisions in amplitude.

e. ADJUST—CH 2 GAIN adjustment (front panel) for exactly five divisions of deflection. To adjust, press in the GAIN knob with a screwdriver and turn until the GAIN control is engaged.

f. Disconnect the standard amplitude calibrator from the CH 2 input connector and connect it to the CH 1 input connector.

g. Set the DISPLAY MODE switch to CH 1.

h. Position the display to the center of the graticule with the CH 1 POSITION control.

i. CHECK—CRT display for exactly five divisions in amplitude.

j. ADJUST—CH 1 GAIN adjustment (front part) for exactly five divisions of deflection.

k. Disconnect all test equipment.

3. Adjust Channel 1 and 2 Input Capacitance

a. Remove the 7A18A from the Indicator Oscilloscope. Place the 7A18A on the plug-in extender and plug the extender into the left vertical compartment.

b. Set the CH 1 and CH 2 VOLTS/DIV switches to 5 mV.

c. Connect the square-wave generator high-amplitude output to the CH 1 Input connector with the 42-inch cable, 10X BNC attenuator, in-line 50-ohm GR termination, and 20 pF normalizer.

d. Set the square-wave generator for a six-division display (30 millivolts) of a one-kilohertz signal.

e. Set the time-base unit for a triggered display at a sweep rate of .2 millisecond/division.

f. CHECK—CRT display for square-wave with square corner.

g. ADJUST—Channel 1 C100 for optimum square corner on the displayed waveform (use tuning tool). See Fig. 4-1 for adjustment location.

h. Disconnect the normalizer from the CH 1 input connector and connect it to the CH 2 input connector.

i. Set the DISPLAY MODE switch to CH 2.

j. CHECK—CRT display for square-wave with square corner.

k. ADJUST—Channel 1 C100 for optimum square corner on the displayed waveform. See Fig. 4-1 for adjustment locations.

l. Disconnect all test equipment.

m. Remove the 7A18A and plug-in extender from the Indicator Oscilloscope. Install the 7A18A, only in the left vertical compartment.

4. Adjust Attenuator Compensation

a. Connect the square-wave generator high-amplitude output to the CH 2 input connector with the 42-inch BNC cable, 10X BNC attenuator, in-line 50-ohm BNC termination, and 20 pF normalizer.

b. Set the CH 1 and CH 2 VOLTS/DIV switches to 10 mV.

c. Set the square-wave generator for a six-division display (60 millivolts) of one-kilohertz signal.

d. CHECK—CRT display at each CH 2 VOLTS/DIV switch position listed in Table 4-3 for square corner and flat

top within 0.06 division. Re-adjust the generator output at each switch position to provide six divisions of deflection.

e. ADJUST—CH 2 attenuator compensations as given in Table 4-3 for optimum square corner and flat top on the displayed waveform (use tuning tool). Re-adjust the generator output at each switch position to provide six divisions of deflection. See Fig. 4-1 for adjustment location.

f. Disconnect the normalizer from CH 2 and connect the signal to the CH 1 input connector.

g. Set the DISPLAY MODE switch to CH 1.

h. CHECK—CRT display at each CH 1 VOLTS/DIV switch position listed in Table 4-3 for square corner and flat top within 0.06 division. Re-adjust the generator output at each switch position to provide six divisions of deflection.

i. ADJUST—CH 1 attenuator compensations as given in Table 4-3 for optimum square corner and flat top on the displayed waveform. Re-adjust the generator output at each switch position to provide six divisions of deflection. See Fig. 4-1 for adjustment location.

j. Disconnect all test equipment.

Table 4-3
Attenuator Compensation

VOLTS/DIV Switch Setting	Adjust for Optimum	
	Square Corner	Flat Top
10 mV	C106	C107
20 mV	C110	C111
50 mV	C114	C115
0.1 V	Check	Check
Remove 10X BNC attenuator		
0.2 V	Check	Check
0.5 V	C118	C119
1V	Check	Check
Replace in-line 50-ohm BNC termination with BNC to BNC male adapter		
2 V	Check	Check
5 V	Check	Check

5. Adjust Channel 1 and 2 High-Frequency Compensation

a. Set the CH 1 and CH 2 VOLTS/DIV switches to 10 mV.

b. Connect the square-wave generator fast-rise output to the CH 1 input connector with the 42-inch BNC cable, 10X BNC attenuator, and in-line 50-ohm BNC termination.

c. Set the square-wave generator for a six-division display (60 millivolts) of a 100 kilohertz signal.

d. Set the time-base unit for a triggered display at a sweep rate of 2 microseconds/division.

NOTE

In the following steps, change the time-base unit magnifier from X1 to X10 and compare the response at both sweep rates.

e. CHECK—Crt display for optimum square-wave response with aberrations not to exceed 0.24 division peak-to-peak.

f. ADJUST—C245, R245, and C275, for optimum square-wave response with minimum aberrations. Use the low-capacitance screwdriver to adjust the variable capacitors. Repeat these adjustments until optimum response is obtained. See Fig. 4-1 for adjustment location.

g. Disconnect the termination from the CH 1 input connector and connect it to the CH 2 input connector.

h. Set the DISPLAY MODE switch to CH 2.

i. CHECK—CRT display for optimum square-wave response with aberrations not to exceed 0.24 division peak-to-peak.

j. ADJUST—C445, R445, and C375, for optimum square-wave response with minimum aberrations. Use the low-capacitance screwdriver to adjust the variable capacitors. Repeat these adjustments until optimum response is obtained. See Fig. 4-1 for adjustment location.

This completes the Calibration of the 7A18A. Disconnect all test equipment. Replace the left side shield on the 7A18A and the left side panel on the Indicator Oscilloscope.



MAINTENANCE

Introduction

This section of the manual contains maintenance information for use in preventive maintenance, corrective maintenance, and troubleshooting of the 7A18A.

Further maintenance information relating to component color codes and soldering techniques can be found in the instruction manuals for the 7000-series oscilloscopes.

PREVENTIVE MAINTENANCE

General

Preventive maintenance, consisting of cleaning, visual inspection, lubrication, etc., performed on a regular basis, will improve the reliability of this instrument. Periodic checks on the semiconductor devices used in the unit are not recommended as a preventive maintenance measure. See semiconductor-checking information given under Troubleshooting.

Cleaning

CAUTION

Avoid the use of chemical cleaning agents which might damage the plastics in this instrument. Avoid chemicals containing benzene, toluene, xylene, acetone, or similar solvents.

Front Panel. Loose dust may be removed with a soft cloth or a dry brush. Water and mild detergent may be used; however, abrasive cleaners should not be used.

Interior. Cleaning the interior of the unit should precede calibration, since the cleaning process could alter the settings of the calibration adjustments. Use low-velocity compressed air to blow off the accumulated dust. Hardened dirt can be removed with a soft, dry brush, cotton-tipped swab, or cloth dampened with a mild detergent and water solution.

Lubrication

Use a cleaning-type lubricant on shaft bushings, interconnecting plug and contacts. Lubricate switch detents with

a heavier grease. A lubrication kit containing their necessary lubricating materials and instructions is available through any Tektronix Field Office. Order Tektronix Part Number 003-0342-02.

Recalibration

To ensure accurate measurements, the 7A18A should be checked after each 1000 hours of operation or every six months if used infrequently. A complete performance check procedure is given in Part I of Section 4.

The performance check procedure can be helpful in isolating major troubles in the unit. Moreover, minor troubles not apparent during regular operation may be revealed and corrected.

TROUBLESHOOTING

General

The following is provided to augment information contained in other sections of this manual when troubleshooting the 7A18A. The Schematic Diagrams, Circuit Description, and Calibration sections should be used to full advantage. The Circuit Description section gives detailed information on circuit behavior and output requirements.

Troubleshooting Aids

Diagrams. Circuit diagrams are given on foldout pages in Section 8. The circuit number and electrical value of each component in this instrument are shown on the diagrams. Important voltages are also shown.

Circuit Board. The circuit board used in the 7A18A is outlined on the schematic diagrams, and a illustration of the board is shown on the back of Diagram 1. Each board-mounted electrical component is identified on the illustration by its circuit number.

Component and Wiring Color Code. Colored stripes or dots on resistors and capacitors signify electrical values, tolerances, etc., according to the EIA standard color code. Components not color coded usually have the value printed on the body.

The insulated wires used for interconnection in the 7A18A are color coded to facilitate tracing a wire from one point to another in the unit.

Semiconductor Lead Configuration. Figure 5-1 shows the lead configuration of the semiconductor devices used in this instrument.

Troubleshooting Equipment

The following equipment is useful for troubleshooting the 7A18A.

1. Semiconductor Tester—Some means of testing the transistors, diodes, and FET's used in this instrument is helpful. A transistor-curve tracer such as the Tektronix Type 576 will give the most complete information.

2. DC Voltmeter and Ohmmeter—A voltmeter for checking voltages within the circuit and an ohmmeter for checking resistors and diodes are required.

3. Test Oscilloscope—A test oscilloscope is required to view waveforms at different points in the circuit.

A Tektronix 7000-Series Oscilloscope equipped with a readout system, 7D13A Digital Multimeter unit, 7B-Series Time-Base Unit, and a 7A-Series Amplifier Unit with a 10X probe will meet the needs for items 2 and 3.

Troubleshooting Procedure

This troubleshooting procedure is arranged in an order which checks the simple trouble possibilities before proceeding with extensive troubleshooting.

1. Check Control Setting. An incorrect setting of the 7A18A controls can indicate a trouble that does not exist. If there is any question about the correct function or operation of a control or front-panel connector, see the Operating Instructions section.

2. Check Associated Equipment. Before proceeding with troubleshooting of the 7A18A, check that the equipment

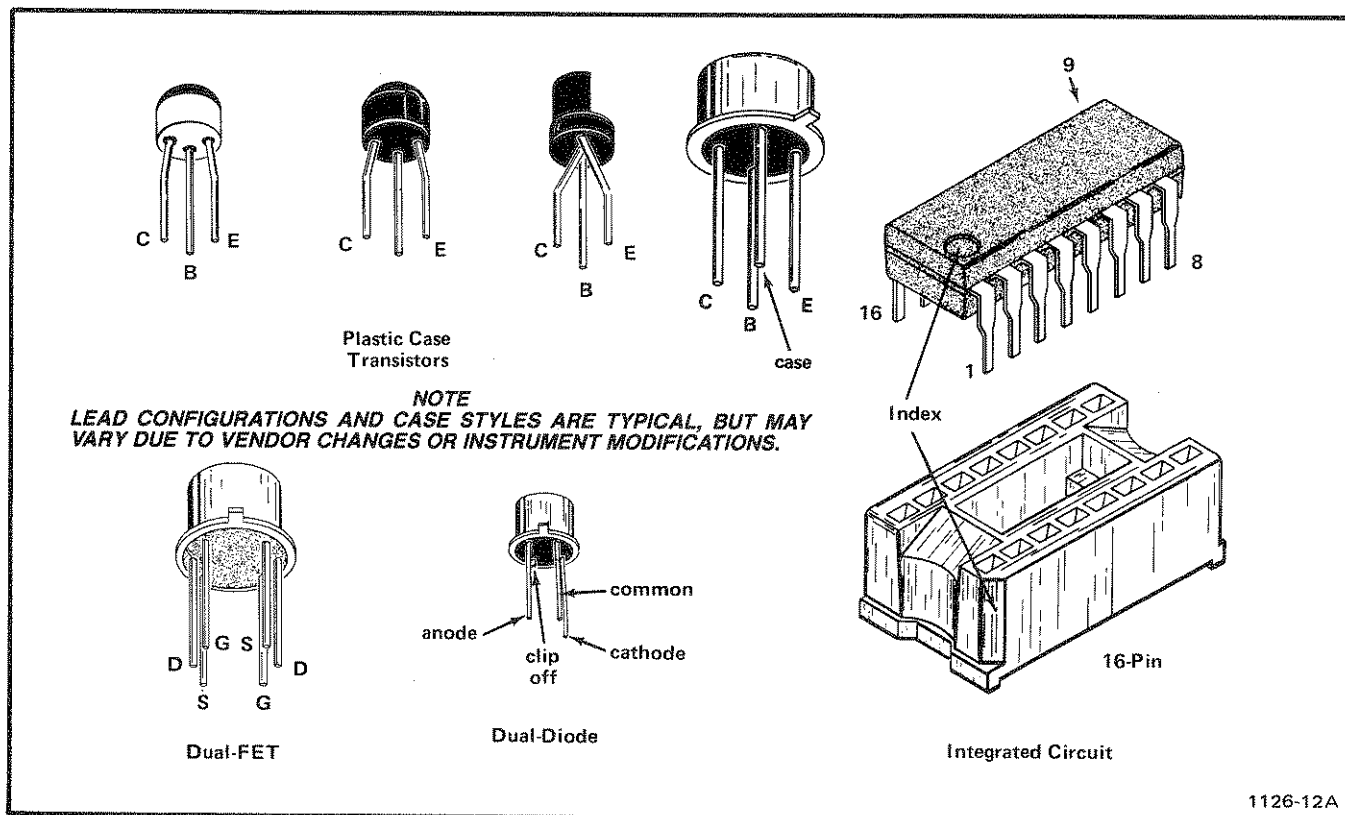

Fig. 5-1. Electrode configuration for semiconductors used in this instrument.

used with this instrument is operating correctly. If possible, substitute an amplifier unit known to be operating correctly into the indicator unit and see if the problem persists. Check that the inputs are properly connected and that the interconnecting cables are not defective.

3. **Visual Check.** Visually check the portion of the instrument in which the trouble is suspected. Many troubles can be located by visual indications, such as unsoldered connections, broken wires, damaged circuit boards, damaged components, etc.

4. **Check Instrument Performance.** Check the calibration of the unit, or the affected circuit by performing Part I—Performance Check of Section 4. The apparent trouble may only be a result of misadjustment and may be corrected by calibration. Complete calibration instructions are given in Part II of Section 4.

5. **Check Voltages and Waveforms.** Often the defective component or stage can be located by checking for the corrected voltage or waveform in the circuit. Typical voltages and waveforms are given on the diagrams; however, these are not absolute and may vary slightly between instrument. To obtain operating conditions similar to those used to take these readings, see the instructions in the Diagrams section.

6. **Check Individual Components.** The following methods are provided for checking the individual components in the 7A18A. Components which are soldered in place are best checked by disconnecting one end to isolate the measurement from the effects of surrounding circuitry.

A. **TRANSISTORS AND INTEGRATED CIRCUITS.** The best check of transistor and integrated circuit operation is actual performance under operating conditions. If a transistor or integrated circuit is suspected of being defective, it can best be checked by substituting a component known to be good; however, be sure that circuit conditions are not such that a replacement might also be damaged. If substitute transistors are not available, use a dynamic tester (such as TEKTRONIX 576). Static-type testers may be used, but since they do not check operation under simulated operating conditions some defects may go unnoticed. Figure 5-1 shows base pin and socket arrangements of semiconductor devices. Be sure the power is off before attempting to remove or replace any transistor or integrated circuit.

Integrated circuits can be checked with a voltmeter, test oscilloscope, or by direct substitution. A good understanding of the circuit description is essential to troubleshooting

circuits using integrated circuits. Use care when checking voltages and waveforms around the integrated circuits so that adjacent leads are not shorted together. An integrated-circuit test clip provides a convenient means of clipping a test probe to the 14- and 16-pin integrated circuits. This device also doubles as an integrated-circuit extraction tool.

B. **DIODES.** A diode can be checked for an open or for a short circuit by measuring the resistance between terminals with an ohmmeter set to the R X 1k scale. The diode resistance should be very high in one direction and very low when the meter leads are reversed. Do not check tunnel diodes or back diodes with an ohmmeter.



Do not use an ohmmeter scale that has a high internal current. High currents may damage the diodes.

C. **RESISTORS.** Check resistors with an ohmmeter. Resistor tolerance is given in the Electrical Parts List. Resistors normally do not need to be replaced unless the measured value varies widely from the specified value.

D. **CAPACITORS.** A leaky or shorted capacitor can be detected by checking resistance with an ohmmeter on the highest scale. Use an ohmmeter which will not exceed the voltage rating of the capacitor. The resistance rating should be high after initial charge of the capacitor. An open capacitor can best be detected with a capacitance meter, or by checking whether the capacitor passes AC signals.

7. **Repair and Readjust the Circuit.** Special techniques required to replace components in this unit are given under Component Replacement. Be sure to check the performance of any circuit that has been repaired or that has had any electrical components replaced. Recalibration of the affected circuit may be necessary.

REPLACEMENT PARTS

Standard Parts

All electrical and mechanical part replacements for the 7A18A can be obtained through your local Tektronix Field Office or representative. However, many of the standard electronic components can be obtained locally in less time than is required to order them from Tektronix, Inc. Before purchasing or ordering replacement parts, check the parts lists for value, tolerance, rating, and description.

NOTE

When selecting replacement parts, it is important to remember that the physical size and shape of the component may affect its performance in the instrument. All replacement parts should be direct replacements unless it is known that a different component will not adversely affect the instrument performance.

Special Parts

Some parts are manufactured or selected by Tektronix to satisfy particular requirements, or are manufactured for Tektronix to our specifications. These special parts are indicated in the parts list by an asterisk preceding the part number. Most of the mechanical parts used in this instrument have been manufactured by Tektronix. Order all special parts directly from your local Tektronix Field Office or representative.

Ordering Parts

When ordering replacement parts from Tektronix, Inc., refer to the Parts Ordering Information and Special Notes and Symbols on the page immediately preceding the Electrical Parts List section. Include the following information:

1. Instrument type (7A18A)
2. Instrument Serial Number
3. A description of the part (if electrical, include the circuit number)
4. Tektronix Part Number.

Soldering Techniques

Attenuator Circuit Boards. The Attenuator circuit boards are made from polyphenylene oxide because of its excellent electrical characteristics. Use more than normal care when cleaning or soldering this material. The following rules should be observed when removing or replacing parts:

1. Use a very small soldering iron (not over 15 watts).
2. Do not apply more heat, or apply heat for a longer time, than is absolutely necessary.
3. Use a vacuum-type desoldering tool to remove the excess solder from the circuit board.

4. Do not apply any solvent containing ketones, esters, or halogenated hydrocarbons.

5. To clean, use only water-soluble detergents, ethyl, methyl, or isopropyl alcohol.

COMPONENT REPLACEMENT**General**

The exploded-view drawing associated with the Mechanical Parts List may be helpful when disassembling or reassembling individual components or sub-assemblies.

Circuit Board Removal

In general, the circuit boards used in the 7A18A need never be removed unless they must be replaced. Electrical connections to the boards are made by soldered connections. If it is necessary to replace a circuit board assembly, use the following procedures.

A. READOUT CIRCUIT BOARD REMOVAL

1. Disconnect the wires connected to the outside of the board.
2. Remove the seven screws holding the board to the mounting surface.
3. Disconnect the wires connected to the inside of the board.
4. Remove the board from the unit.
5. To replace the board, reverse the order of removal.

B. ATTENUATOR CIRCUIT BOARD REMOVAL

1. Remove the readout board as outlined in the previous procedure.
2. Disconnect the resistor/capacitor connected to the rear of the board.
3. Loosen the front set screw on the VARIABLE/GAIN control shaft coupling (use a 0.050-inch hex-key wrench).
4. Remove the red VARIABLE control knob and rod from the control shaft.

5. Remove the remaining front-panel knobs using a 1/16-inch hex-key wrench.

6. Remove the front panel from the instrument.

7. Remove the attenuator shields.

8. Disconnect the wires and resistor from the input BNC connector.

9. Remove the input BNC connector.

10. Remove the POSITION control using a 5/16-inch nut driver.

11. Remove the attenuator board with cam switch from the instrument.

12. To replace the board, reverse the order of removal.

C. AMPLIFIER CIRCUIT BOARD REMOVAL

1. Remove the Readout circuit boards as given previously.

2. Remove the plastic plug-in guide from the rear of the instrument.

3. Disconnect the wires connected to the board from the front-panel controls.

4. Loosen the front hex-socket screw in the front coupling of the VARIABLE control shaft using a 0.050-inch hex-key wrench. Pull the VARIABLE knob and shaft from the front of the instrument.

5. Loosen the front hex-socket screw in the coupling between the DISPLAY MODE and TRIGGER SOURCE switch sections. Pull the TRIGGER SOURCE knob and long shaft from the front of the instrument.

6. Loosen the front hex-socket screw in the coupling of the DISPLAY MODE switch shaft using a 5/16-inch hex-key wrench. Pull the DISPLAY MODE knob and long shaft from the front of the instrument.

7. Disconnect the resistor-capacitor combinations connected to the ceramic strips at the front of the board.

8. Remove the screws and nuts securing the board to the chassis or other mounting surface.

9. Remove the board from the instrument.

10. To replace, reverse the order of removal.

Switch Replacement

Several types of switches are used in the 7A18A. The following special maintenance information is provided for the cam-type switches and rotary switches.

A. CAM-TYPE SWITCHES

CAUTION

Repair of cam-type switches should be undertaken only by experienced maintenance personnel. Switch alignment and spring tension of the contacts must be carefully maintained for proper operation of the switch. For assistance in maintenance of the cam-type switches, contact your local Tektronix Field Office or representative.

B. ROTARY SWITCHES

Single wafers on the DISPLAY MODE and TRIGGER SOURCE switches are not normally replaced. If any part of these switches is defective, the entire switch assembly should be replaced. A new switch can be ordered through your Tektronix Field Office.

CAUTION

When disconnecting or connecting leads to a wafer-type rotary switch, do not let solder flow around and beyond the rivet on the switch terminal. Excessive solder can destroy the spring tension of the contact.

Transistor and Integrated Circuit Replacement

Transistors and IC's should not be replaced unless they are actually defective. If removed from their sockets during routine maintenance, return them to their original sockets. Special care must be given to integrated circuit leads, be-

cause they can easily be damaged in removal from sockets. Unnecessary replacement or switching of components may affect the calibration of the instrument. When a transistor is replaced, check the operation of that part of the instrument that may be affected.

Recalibration After Repair

After any electrical component has been replaced, the calibration of that particular circuit should be checked, as well as the calibration of other closely related circuits. The Performance Check instructions given in Part I of Section 4 provide a quick and convenient means of checking the instrument operation. The Calibration Procedure in Part II of Section 4 can then be used to adjust the operation to meet the Performance Requirements listed in Section 1.

Repackaging for Shipment

If the Tektronix instrument is to be shipped to a Tektronix Service Center for service or repair, attach a tag showing: owner (with address) and the name of an individual at your firm that can be contacted, complete instrument serial number and a description of the service required.

Save and re-use the package in which your instrument was shipped. If the original packaging is unfit for use or not available, repackage the instrument as follows:

Surround the instrument with polyethylene sheeting to protect the finish of the instrument. Obtain a carton of corrugated cardboard of the correct carton strength and having inside dimensions of no less than six inches more than the instrument dimensions. Cushion the instrument by tightly packing three inches of dunnage or urethane foam between carton and instrument, on all sides. Seal carton with shipping tape or industrial stapler.

The carton test strength for your instrument is 200 pounds.

Selected Component Criteria

During initial calibration selected values of the following components may have been installed to meet certain performance requirements for this instrument. If, during recalibration following corrective maintenance or hours-of-service performance checks, it is determined that one or more of these components needs replacement the following criteria (Table 5-1) should be used.

**Table 5-1
Selected Component Criteria**

Component	Circuit Involved	Range of Values	Criteria/Effects
C246 R246	CH 1 – Input to 2nd Cascode Amplifier	0–50 pF, and 47 k–100 k Ω	All selected for optimum risetime and minimum aberrations.
C545 R545	CH 2 – Input to 2nd Cascode Amplifier	0–50 pF, and 4.7 k–100 k Ω	

OPTION INFORMATION

Your instrument may be equipped with one or more options. This section describes those options, or directs the reader to where the option is documented.

Option 06 DC OFFSET: Described in this section.

The 7A18A with Option 06 is equipped with added DC offset circuits that provide up to ± 200 divisions of baseline offset within the input dynamic range, with uncalibrated front panel variable controls for each channel.

DC OFFSET. The internal DC Balance circuits have been modified to provide up to ± 1 V DC offset directly to the input of each amplifier, which gives up to ± 200 divisions of baseline offset range for all VOLTS/DIV settings.

CONTROLS. Separate CH 1 and CH 2 (uncalibrated) Variable Offset controls are added to the front panel. Each input coupling selector switch has an additional position for the DC offset function.

The variable controls are concentric with the position controls, replacing the IDENTIFY pushbuttons formerly used on the unmodified unit.

APPLICATION. The added Offset facility should be used only for offsetting a DC level in the waveform to be observed. Amplifier characteristics are not suitable for use of this feature for "slideback" type measurements of peak or peak-to-peak high-frequency or pulse waveforms exceeding 15 divisions peak-to-peak amplitude.

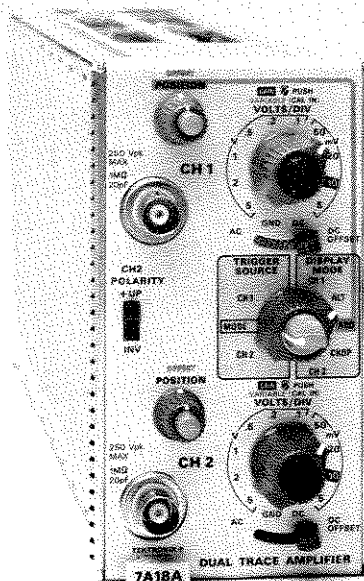

4329-04

Fig. 6-1. 7A18A Option 06.

CHARACTERISTICS

AMPLIFIER LINEAR OFFSET RANGE. Common-mode DC range of the input amplifiers is sufficient to provide linear amplification of signals within normal 7A18A performance specifications at offsets of up to ± 200 divisions.

EFFECTIVE VOLTAGE OFFSET. Effective voltage offset values for calibrated VOLTS/DIV steps are as follows (VARIABLE control in Cal position):

Table 6-1
EFFECTIVE OFFSET RANGE

VOLTS/DIV	Direct	With X10 Probe
5 mV	± 1 V	10 V
10	2	20
20	4	40
50	10	100
.1 V	20	200
.2	40	400
.5	100	1000 ²
1	200	2000 ²
2	400 ¹	4000 ²
5	1000 ¹	10,000 ²

¹Maximum input rating 250 V when direct coupled. Full offset range should not be used above 1 V/DIV.

²Maximum input rating of most probes is 500–600 V. Full offset range should not be used at VOLTS/DIV settings above .2 with 10X probe.

CALIBRATION

CALIBRATION. Perform the following steps for checking Channel 1 and 2 OFFSET Range:

a. Reset the Input coupling to GND and the VOLTS/DIV to 5 mV and position the trace to the center horizontal graticule line.

b. Set the standard amplitude calibrator for one-volt +DC output and set the input coupling switch to DC OFFSET.

c. CHECK—Using the OFFSET control, check that the trace can be returned to graticule center.

d. Set the standard amplitude calibrator for a minute (—) one-volt DC output.

e. CHECK—Using the OFFSET control, check that the trace can be returned to graticule center.

CIRCUIT DESCRIPTION: DC levels of up to ± 200 divisions can be offset by switching the input coupling to DC OFFSET and using the OFFSET control. In the DC OFFSET mode, the selected offset voltage from OFFSET control R12 (R22, CH 2), is applied to the base of Q320 (Q520, CH 2) through current-limiting resistor R320 (R520, CH 2). This additional bias voltage is used to balance the differential input of Q220 (Q420, CH 2). LED's are inserted in series with both CR220 and CR221 (CR420, CR421, CH 2) to allow a larger voltage swing at the base of Q220 (Q420, CH 2).

See Fig. 6-2 for a side-view of the 7A18A-Option 06.

See Section 9 for the exploded view and mechanical parts list. The schematics of the Option 06 circuits are shown in Section 8.

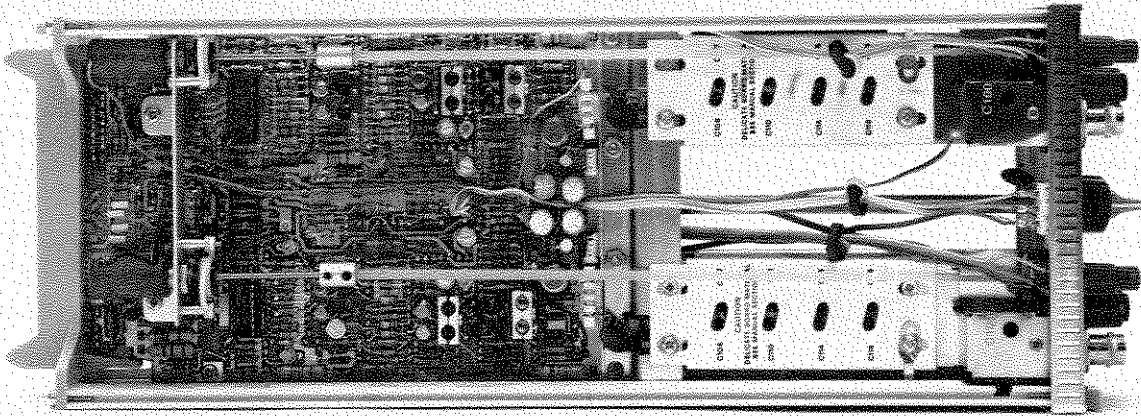

4329-05

Fig. 6-2. Side view of 7A18A—Option 06.

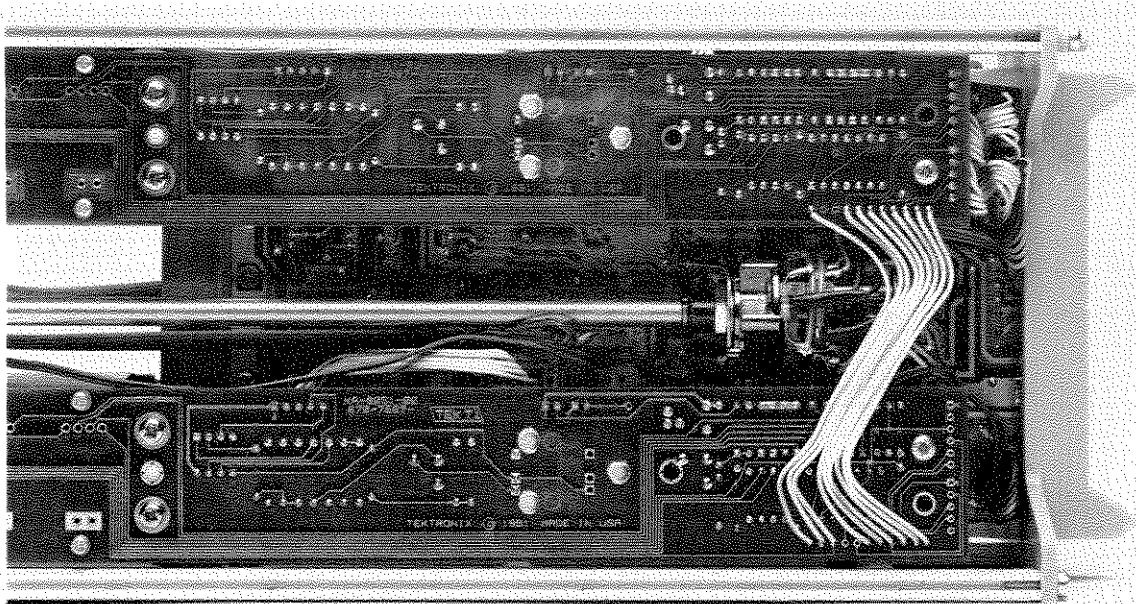

4329-08

Fig. 6-3. Rear view of A2-Amplifier board for either Option 06 or standard 7A18A.

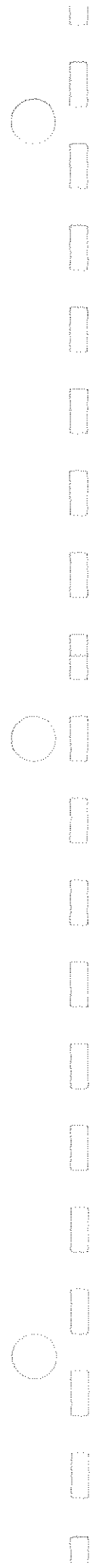

REPLACEABLE ELECTRICAL PARTS

PARTS ORDERING INFORMATION

Replacement parts are available from or through your local Tektronix, Inc. Field Office or representative.

Changes to Tektronix instruments are sometimes made to accommodate improved components as they become available, and to give you the benefit of the latest circuit improvements developed in our engineering department. It is therefore important, when ordering parts, to include the following information in your order: Part number, instrument type or number, serial number, and modification number if applicable.

If a part you have ordered has been replaced with a new or improved part, your local Tektronix, Inc. Field Office or representative will contact you concerning any change in part number.

Change information, if any, is located at the rear of this manual.

LIST OF ASSEMBLIES

A list of assemblies can be found at the beginning of the Electrical Parts List. The assemblies are listed in numerical order. When the complete component number of a part is known, this list will identify the assembly in which the part is located.

CROSS INDEX-MFR. CODE NUMBER TO MANUFACTURER

The Mfr. Code Number to Manufacturer index for the Electrical Parts List is located immediately after this page. The Cross Index provides codes, names and addresses of manufacturers of components listed in the Electrical Parts List.

ABBREVIATIONS

Abbreviations conform to American National Standard Y1.1.

COMPONENT NUMBER (column one of the Electrical Parts List)

A numbering method has been used to identify assemblies, subassemblies and parts. Examples of this numbering method and typical expansions are illustrated by the following:

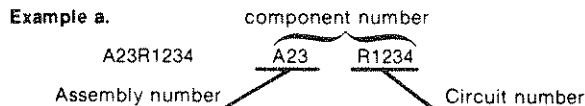

Read: Resistor 1234 of Assembly 23

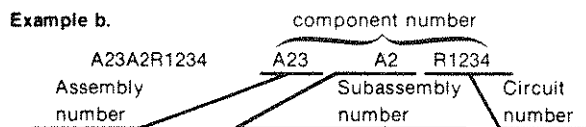

Read: Resistor 1234 of Subassembly 2 of Assembly 23

Only the circuit number will appear on the diagrams and circuit board illustrations. Each diagram and circuit board illustration is clearly marked with the assembly number. Assembly numbers are also marked on the mechanical exploded views located in the Mechanical Parts List. The component number is obtained by adding the assembly number prefix to the circuit number.

The Electrical Parts List is divided and arranged by assemblies in numerical sequence (e.g., assembly A1 with its subassemblies and parts, precedes assembly A2 with its subassemblies and parts).

Chassis-mounted parts have no assembly number prefix and are located at the end of the Electrical Parts List.

TEKTRONIX PART NO. (column two of the Electrical Parts List)

Indicates part number to be used when ordering replacement part from Tektronix.

SERIAL/MODEL NO. (columns three and four of the Electrical Parts List)

Column three (3) indicates the serial number at which the part was first used. Column four (4) indicates the serial number at which the part was removed. No serial number entered indicates part is good for all serial numbers.

NAME & DESCRIPTION (column five of the Electrical Parts List)

In the Parts List, an Item Name is separated from the description by a colon (:). Because of space limitations, an Item Name may sometimes appear as incomplete. For further Item Name identification, the U.S. Federal Cataloging Handbook H6-1 can be utilized where possible.

MFR. CODE (column six of the Electrical Parts List)

Indicates the code number of the actual manufacturer of the part. (Code to name and address cross reference can be found immediately after this page.)

MFR. PART NUMBER (column seven of the Electrical Parts List)

Indicates actual manufacturers part number.

CROSS INDEX—MFR. CODE NUMBER TO MANUFACTURER

Mfr. Code	Manufacturer	Address	City, State, Zip
01121	ALLEN-BRADLEY COMPANY	1201 2ND STREET SOUTH	MILWAUKEE, WI 53204
01295	TEXAS INSTRUMENTS, INC. SEMICONDUCTOR GROUP	P.O. BOX 5012	DALLAS, TX 75222
02111	SPECTROL ELECTRONICS CORPORATION	17070 EAST GALE AVENUE	CITY OF INDUSTRY, CA 91745
03508	GENERAL ELECTRIC COMPANY, SEMI-CONDUCTOR PRODUCTS DEPARTMENT	ELECTRONICS PARK	SYRACUSE, NY 13201
04222	AVX CERAMICS, DIVISION OF AVX CORP.	P O BOX 867	MYRTLE BEACH, SC 29577
04713	MOTOROLA, INC., SEMICONDUCTOR PROD. DIV.	5005 E MCDOWELL RD, PO BOX 20923	PHOENIX, AZ 85036
05397	UNION CARBIDE CORPORATION, MATERIALS SYSTEMS DIVISION	11901 MADISON AVENUE	CLEVELAND, OH 44101
07263	FAIRCHILD SEMICONDUCTOR, A DIV. OF FAIRCHILD CAMERA AND INSTRUMENT CORP.	464 ELLIS STREET	MOUNTAIN VIEW, CA 94042
12697	CLAROSTAT MFG. CO., INC.	LOWER WASHINGTON STREET	DOVER, NH 03820
12969	UNITRODE CORPORATION	580 PLEASANT STREET	WATERTOWN, MA 02172
17856	SILICONIX, INC.	2201 LAURELWOOD DRIVE	SANTA CLARA, CA 95054
22229	SOLITRON DEVICES, INC., SEMICONDUCTOR GROUP	8808 BALBOA AVENUE	SAN DIEGO OPERS, CA 92123
24546	CORNING GLASS WORKS, ELECTRONIC COMPONENTS DIVISION	550 HIGH STREET	BRADFORD, PA 16701
24931	SPECIALITY CONNECTOR CO., INC.	2620 ENDRESS PLACE	GREENWOOD, IN 46142
32997	BOURNS, INC., TRIMPOT PRODUCTS DIV.	1200 COLUMBIA AVE.	RIVERSIDE, CA 92507
34430	MONSANTO COMMERCIAL PRODUCT, CO. FABRICATOR PRODUCTS DIV.	BOX 3790, 611 EAST CERRITOS AVE.	ANAHEIM, CA 92803
54473	MATSUSHITA ELECTRIC, CORP. OF AMERICA	1 PANASONIC WAY	SECAUCUS, NJ 07094
57668	R-OHM CORP.	16931 MILLIKEN AVE.	IRVINE, CA 92713
59660	TUSONIX INC.	2155 N FORBES BLVD	TUCSON, AZ 85705
59821	CENTRALAB INC SUB NORTH AMERICAN PHILIPS CORP	7158 MERCHANT AVE	EL PASO, TX 79915
72982	ERIE TECHNOLOGICAL PRODUCTS, INC.	644 W. 12TH ST.	ERIE, PA 16512
73138	BECKMAN INSTRUMENTS, INC., HELIPOT DIV.	2500 HARBOR BLVD.	FULLERTON, CA 92634
74970	JOHNSON, E. F., CO.	299 10TH AVE. S. W.	WASECA, MN 56093
75042	TRW ELECTRONIC COMPONENTS, IRC FIXED RESISTORS, PHILADELPHIA DIVISION	401 N. BROAD ST. P O BOX 500	PHILADELPHIA, PA 19108 BEAVERTON, OR 97077
80009	TEKTRONIX, INC.	5555 N. ELSTON AVE.	CHICAGO, IL 60630
82389	SWITCHCRAFT, INC.	P. O. BOX 609	COLUMBUS, NE 68601
91637	DALE ELECTRONICS, INC.	1501 FIRST ST	SAN FERNANDO, CA 91341
96733	SAN FERNANDO ELECTRIC MFG CO		

Component No.	Tektronix Part No.	Serial/Model No.		Name & Description	Mfr Code	Mfr Part Number
		Eff	Dscont			
ASSEMBLIES						
A1	672-1068-00			CKT BOARD ASSY:CAM SWITCH AND READOUT	80009	672-1068-00
A1A1	670-1706-02			CKT BOARD ASSY:ATTENUATOR	80009	670-1706-02
A1A2	263-1105-01			SW,CAM ACTR,ASSY:VOLTS/DIV	80009	263-1105-01
A1A3	670-7667-00			CKT BOARD ASSY:READOUT	80009	670-7667-00
A2	670-7666-00	B010100	B011884	CKT BOARD ASSY:AMPLIFIER	80009	670-7666-00
A2	670-7666-02	B011885		CKT BOARD ASSY:AMPLIFIER	80009	670-7666-02
A2	670-7666-01	B010100	B011884	CKT BOARD ASSY:AMPLIFIER	80009	670-7666-01
A2	-----			(OPTION 06 ONLY)		
A2	670-7666-03	B011885		CKT BOARD ASSY:AMPLIFIER	80009	670-7666-03
A2	-----			(OPTION 06 ONLY)		
A1	672-1068-00			CKT BOARD ASSY:CAM SWITCH AND READOUT	80009	672-1068-00
A1A1	670-1706-02			CKT BOARD ASSY:ATTENUATOR	80009	670-1706-02
A1A1C100	281-0064-00			CAP.,VAR,PLSTC:0.25-1.5PF,600V	74970	273-0001-101
A1A1R102	317-0105-00			RES.,FXD,CMPSN:1M OHM,5%,0.125W	01121	BB1055
A1A1R130	322-0481-01			RES.,FXD,FILM:1M OHM,0.5%,0.25W	75042	CEBT0-1004D
A1A2	263-1105-01			SW,CAM ACTR,ASSY:VOLTS/DIV	80009	263-1105-01
A1A2S100	105-0242-02			ACTUATOR,CAM SW:AC,GND,DC,DC OFFSET	80009	105-0242-02
A1A2S200	105-0241-01			ACTUATOR,CAM SW:ATTEN	80009	105-0241-01
A1A2S300	105-0242-02			ACTUATOR,CAM SW:AC,GND,DC,DC OFFSET	80009	105-0242-02
A1A2S400	105-0241-01			ACTUATOR,CAM SW:ATTEN	80009	105-0241-01

Component No.	Tektronix Part No.	Serial/Model No. Eff	Dscont	Name & Description	Mfr Code	Mfr Part Number
A1A3	670-7667-00			CKT BOARD ASSY:READOUT	80009	670-7667-00
A1A3C621	283-0177-00			CAP.,FXD,CER DI:1UF,+80-20%,25V	04222	SR302E105ZAA
A1A3CR621	152-0141-02			SEMICON DVC,DI:SW,SI,30V,150MA,30V,DO-35	12969	NDP0263 (1N4152)
A1A3CR630	152-0141-02			SEMICON DVC,DI:SW,SI,30V,150MA,30V,DO-35	12969	NDP0263 (1N4152)
A1A3CR631	152-0141-02			SEMICON DVC,DI:SW,SI,30V,150MA,30V,DO-35	12969	NDP0263 (1N4152)
A1A3CR634	152-0141-02			SEMICON DVC,DI:SW,SI,30V,150MA,30V,DO-35	12969	NDP0263 (1N4152)
A1A3CR635	152-0141-02			SEMICON DVC,DI:SW,SI,30V,150MA,30V,DO-35	12969	NDP0263 (1N4152)
A1A3CR638	152-0141-02			SEMICON DVC,DI:SW,SI,30V,150MA,30V,DO-35	12969	NDP0263 (1N4152)
A1A3CR639	152-0141-02			SEMICON DVC,DI:SW,SI,30V,150MA,30V,DO-35	12969	NDP0263 (1N4152)
A1A3CR641	152-0141-02			SEMICON DVC,DI:SW,SI,30V,150MA,30V,DO-35	12969	NDP0263 (1N4152)
A1A3CR647	152-0141-02			SEMICON DVC,DI:SW,SI,30V,150MA,30V,DO-35	12969	NDP0263 (1N4152)
A1A3CR648	152-0141-02			SEMICON DVC,DI:SW,SI,30V,150MA,30V,DO-35	12969	NDP0263 (1N4152)
A1A3Q620	151-0281-00			TRANSISTOR:SILICON,NPN	03508	X16P4039
A1A3R620	315-0471-00			RES.,FXD,CMPSN:470 OHM,5%,0.25W	57668	NTR25J-E470E
A1A3R621	321-0222-00			RES.,FXD,FILM:2K OHM,1%,0.125W	91637	MFF1816G20000F
A1A3R622	321-0299-00			RES.,FXD,FILM:12.7K OHM,1%,0.125W	91637	MFF1816G12701F
A1A3R629	315-0101-00			RES.,FXD,CMPSN:100 OHM,5%,0.25W	57668	NTR25J-E 100E
A1A3R630	315-0154-00			RES.,FXD,CMPSN:150K OHM,5%,0.25W	57668	NTR25J-E150K
A1A3R631	315-0753-00			RES.,FXD,CMPSN:75K OHM,5%,0.25W	57668	NTR25J-E75K0
A1A3R633	315-0753-00			RES.,FXD,CMPSN:75K OHM,5%,0.25W	57668	NTR25J-E75K0
A1A3R634	315-0154-00			RES.,FXD,CMPSN:150K OHM,5%,0.25W	57668	NTR25J-E150K
A1A3R635	321-0344-00			RES.,FXD,FILM:37.4K OHM,1%,0.125W	91637	MFF1816G37401F
A1A3R637	315-0154-00			RES.,FXD,CMPSN:150K OHM,5%,0.25W	57668	NTR25J-E150K
A1A3R638	315-0154-00			RES.,FXD,CMPSN:150K OHM,5%,0.25W	57668	NTR25J-E150K
A1A3R639	315-0753-00			RES.,FXD,CMPSN:75K OHM,5%,0.25W	57668	NTR25J-E75K0
A1A3R640	315-0753-00			RES.,FXD,CMPSN:75K OHM,5%,0.25W	57668	NTR25J-E75K0
A1A3R641	315-0154-00			RES.,FXD,CMPSN:150K OHM,5%,0.25W	57668	NTR25J-E150K
A1A3R642	315-0513-00			RES.,FXD,CMPSN:51K OHM,5%,0.25W	57668	NTR25J-E51K0
A1A3R643	321-0344-00			RES.,FXD,FILM:37.4K OHM,1%,0.125W	91637	MFF1816G37401F
A1A3R645	315-0154-00			RES.,FXD,CMPSN:150K OHM,5%,0.25W	57668	NTR25J-E150K
A1A3R646	315-0154-00			RES.,FXD,CMPSN:150K OHM,5%,0.25W	57668	NTR25J-E150K
A1A3R647	315-0133-00			RES.,FXD,CMPSN:13K OHM,5%,0.25W	57668	NTR25J-E 13K
A1A3R648	315-0154-00			RES.,FXD,CMPSN:150K OHM,5%,0.25W	57668	NTR25J-E150K
A1A3R660	321-0085-00	B010100	B011649	RES.,FXD,FILM:75 OHM,1%,0.125W	91637	CMF55116G75R00F
A1A3R660	321-0072-00	B011650		RES.,FXD,FILM:54.9 OHM,1%,0.125W	91637	MFF1816G54R90F
A1A3R661	321-0118-00			RES.,FXD,FILM:165 OHM,1%,0.125W	91637	MFF1816G165R0F
A1A3R663	311-1853-00			RES.,VAR, NONWIR:2.5K OHM,10%,0.50W	01121	18M838
A1A3R665	321-0108-00			RES.,FXD,FILM:130 OHM,1%,0.125W	91637	CMF55116G13000F
A1A3R666	321-0082-00			RES.,FXD,FILM:69.8 OHM,1%,0.125W	91637	CMF55116G69R80F
A1A3R668	311-1854-00			RES.,VAR, NONWIR:1K OHM,10%,0.50W	01121	14M403
A1A3R670	321-0256-00			RES.,FXD,FILM:4.53K OHM,1%,0.125W	91637	MFF1816G45300F
A1A3R672	315-0104-00			RES.,FXD,CMPSN:100K OHM,5%,0.25W	57668	NTR25J-E100K
A1A3R675	321-0220-00			RES.,FXD,FILM:1.91K OHM,1%,0.125W	91637	MFF1816G19100F
A1A3R676	321-0070-00			RES.,FXD,FILM:52.3 OHM,1%,0.125W	57668	CRB14FXE52.3OHM
A1A3R677	321-0070-00			RES.,FXD,FILM:52.3 OHM,1%,0.125W	57668	CRB14FXE52.3OHM
A1A3R679	315-0243-00			RES.,FXD,CMPSN:24K OHM,5%,0.25W	57668	NTR25J-E24K0
A1A3R681	321-0256-00			RES.,FXD,FILM:4.53K OHM,1%,0.125W	91637	MFF1816G45300F
A1A3S667	131-0604-00			CONTACT,ELEC:CKT BD SW,SPR,CU BE	80009	131-0604-00
A1A3S667	-----			(QUANTITY OF 3)		
A1A3U675	156-0158-07			MICROCIRCUIT,LI:DUAL OPNL AMPL,SCREENED	01295	MC1458JG4

Component No.	Tektronix Part No.	Serial/Model No. Eff	Dscont	Name & Description	Mfr Code	Mfr Part Number
A2	670-7666-00	B010100	B011884	CKT BOARD ASSY:AMPLIFIER	80009	670-7666-00
A2	670-7666-02	B011885		CKT BOARD ASSY:AMPLIFIER	80009	670-7666-02
A2	670-7666-01	B010100	B011884	CKT BOARD ASSY:AMPLIFIER	80009	670-7666-01
A2	-----			(OPTION 06 ONLY)		
A2	670-7666-03	B011885		CKT BOARD ASSY:AMPLIFIER	80009	670-7666-03
A2	-----			(OPTION 06 ONLY)		
A2C210	283-0001-00			CAP.,FXD,CER DI:0.005UF,+100-0%,500V	59821	2DDH61L502P
A2C212	281-0557-00	B010100	B011884	CAP.,FXD,CER DI:1.8PF,10%,500V	04222	7001-COK-1R8B
A2C212	281-0529-00	B011885		CAP.,FXD,CER DI:1.5PF,+/-0.25PF,500V	04222	7001-COK1R5C
A2C216	290-0745-00			CAP.,FXD,ELCTLT:22UF,+50-10%,25V	54473	ECE-A25V22L
A2C225	281-0820-00			CAP.,FXD,CER DI:680PF,10%,50V	05397	C114K681K1X5CA
A2C241	281-0812-00			CAP.,FXD,CER DI:1000PF,10%,100V	04222	MA101C102KAA
A2C245	281-0221-00			CAP.,VAR,CER DI:2-10PF,100V	59660	513-013A 2 0-10
A2C246	281-0811-00			CAP.,FXD,CER DI:10PF,10%,100V	96733	R2911
A2C246	-----			(NOMINAL VALUE SELECTED,0-50PF MAX)		
A2C256	281-0812-00			CAP.,FXD,CER DI:1000PF,10%,100V	04222	MA101C102KAA
A2C257	281-0812-00			CAP.,FXD,CER DI:1000PF,10%,100V	04222	MA101C102KAA
A2C264	281-0819-00			CAP.,FXD,CER DI:33PF,5%,50V	72982	8035BC0G330
A2C270	281-0812-00			CAP.,FXD,CER DI:1000PF,10%,100V	04222	MA101C102KAA
A2C274	281-0810-00			CAP.,FXD,CER DI:5.6PF,0.5%,100V	04222	MA101A5R6DAA
A2C275	281-0221-00			CAP.,VAR,CER DI:2-10PF,100V	59660	513-013A 2 0-10
A2C278	281-0814-00			CAP.,FXD,CER DI:100PF,10%,100V	04222	GC101A101K
A2C313	281-0812-00			CAP.,FXD,CER DI:1000PF,10%,100V	04222	MA101C102KAA
A2C318	290-0745-00			CAP.,FXD,ELCTLT:22UF,+50-10%,25V	54473	ECE-A25V22L
A2C325	281-0820-00			CAP.,FXD,CER DI:680PF,10%,50V	05397	C114K681K1X5CA
A2C341	281-0812-00			CAP.,FXD,CER DI:1000PF,10%,100V	04222	MA101C102KAA
A2C345	281-0773-00			CAP.,FXD,CER DI:0.1UF,20%,50V	04222	MA201C103KAA
A2C356	281-0812-00			CAP.,FXD,CER DI:1000PF,10%,100V	04222	MA101C102KAA
A2C364	281-0819-00			CAP.,FXD,CER DI:33PF,5%,50V	72982	8035BC0G330
A2C370	281-0812-00			CAP.,FXD,CER DI:1000PF,10%,100V	04222	MA101C102KAA
A2C374	281-0810-00			CAP.,FXD,CER DI:5.6PF,0.5%,100V	04222	MA101A5R6DAA
A2C375	281-0221-00			CAP.,VAR,CER DI:2-10PF,100V	59660	513-013A 2 0-10
A2C378	281-0814-00			CAP.,FXD,CER DI:100PF,10%,100V	04222	GC101A101K
A2C391	281-0773-00			CAP.,FXD,CER DI:0.1UF,20%,50V	04222	MA201C103KAA
A2C392	281-0773-00			CAP.,FXD,CER DI:0.1UF,20%,50V	04222	MA201C103KAA
A2C393	281-0773-00			CAP.,FXD,CER DI:0.1UF,20%,50V	04222	MA201C103KAA
A2C394	281-0773-00			CAP.,FXD,CER DI:0.1UF,20%,50V	04222	MA201C103KAA
A2C395	281-0773-00			CAP.,FXD,CER DI:0.1UF,20%,50V	04222	MA201C103KAA
A2C396	281-0773-00			CAP.,FXD,CER DI:0.1UF,20%,50V	04222	MA201C103KAA
A2C397	281-0773-00			CAP.,FXD,CER DI:0.1UF,20%,50V	04222	MA201C103KAA
A2C398	281-0773-00			CAP.,FXD,CER DI:0.1UF,20%,50V	04222	MA201C103KAA
A2C410	283-0001-00			CAP.,FXD,CER DI:0.005UF,+100-0%,500V	59821	2DDH61L502P
A2C412	281-0557-00	B010100	B011884	CAP.,FXD,CER DI:1.8PF,10%,500V	04222	7001-COK-1R8B
A2C412	281-0529-00	B011885		CAP.,FXD,CER DI:1.5PF,+/-0.25PF,500V	04222	7001-COK1R5C
A2C416	290-0745-00			CAP.,FXD,ELCTLT:22UF,+50-10%,25V	54473	ECE-A25V22L
A2C425	281-0820-00			CAP.,FXD,CER DI:680PF,10%,50V	05397	C114K681K1X5CA
A2C427	281-0812-00			CAP.,FXD,CER DI:1000PF,10%,100V	04222	MA101C102KAA
A2C429	281-0812-00			CAP.,FXD,CER DI:1000PF,10%,100V	04222	MA101C102KAA
A2C441	281-0812-00			CAP.,FXD,CER DI:1000PF,10%,100V	04222	MA101C102KAA
A2C445	281-0221-00			CAP.,VAR,CER DI:2-10PF,100V	59660	513-013A 2 0-10
A2C446	281-0773-00			CAP.,FXD,CER DI:0.1UF,20%,50V	04222	MA201C103KAA
A2C456	281-0812-00			CAP.,FXD,CER DI:1000PF,10%,100V	04222	MA101C102KAA
A2C457	281-0812-00			CAP.,FXD,CER DI:1000PF,10%,100V	04222	MA101C102KAA

Replaceable Electrical Parts—7A18A

Component No.	Tektronix Part No.	Serial/Model No. Eff Dscont	Name & Description	Mfr Code	Mfr Part Number
A2C464	281-0819-00		CAP.,FXD,CER DI:33PF,5%,50V	72982	8035BC0G330
A2C470	281-0812-00		CAP.,FXD,CER DI:1000PF,10%,100V	04222	MA101C102KAA
A2C474	281-0810-00		CAP.,FXD,CER DI:5.6PF,0.5%,100V	04222	MA101A5R6DAA
A2C478	281-0814-00		CAP.,FXD,CER DI:100PF,10%,100V	04222	GC101A101K
A2C513	281-0812-00		CAP.,FXD,CER DI:1000PF,10%,100V	04222	MA101C102KAA
A2C518	290-0745-00		CAP.,FXD,ELCTLT:22UF,+50-10%,25V	54473	ECE-A25V22L
A2C525	281-0820-00		CAP.,FXD,CER DI:680PF,10%,50V	05397	C114K681K1X5CA
A2C527	281-0812-00		CAP.,FXD,CER DI:1000PF,10%,100V	04222	MA101C102KAA
A2C541	281-0812-00		CAP.,FXD,CER DI:1000PF,10%,100V	04222	MA101C102KAA
A2C545	281-0811-00		CAP.,FXD,CER DI:10PF,10%,100V	96733	R2911
A2C545	-----		(NOMINAL VALUE SELECTED,.0-50PF MAX)		
A2C556	281-0812-00		CAP.,FXD,CER DI:1000PF,10%,100V	04222	MA101C102KAA
A2C564	281-0819-00		CAP.,FXD,CER DI:33PF,5%,50V	72982	8035BC0G330
A2C570	281-0812-00		CAP.,FXD,CER DI:1000PF,10%,100V	04222	MA101C102KAA
A2C574	281-0810-00		CAP.,FXD,CER DI:5.6PF,0.5%,100V	04222	MA101A5R6DAA
A2C578	281-0814-00		CAP.,FXD,CER DI:100PF,10%,100V	04222	GC101A101K
A2C584	281-0812-00		CAP.,FXD,CER DI:1000PF,10%,100V	04222	MA101C102KAA
A2C591	281-0773-00		CAP.,FXD,CER DI:0.1UF,20%,50V	04222	MA201C103KAA
A2C592	281-0773-00		CAP.,FXD,CER DI:0.1UF,20%,50V	04222	MA201C103KAA
A2C593	281-0773-00		CAP.,FXD,CER DI:0.1UF,20%,50V	04222	MA201C103KAA
A2C594	281-0773-00		CAP.,FXD,CER DI:0.1UF,20%,50V	04222	MA201C103KAA
A2C595	281-0773-00		CAP.,FXD,CER DI:0.1UF,20%,50V	04222	MA201C103KAA
A2C596	281-0773-00		CAP.,FXD,CER DI:0.1UF,20%,50V	04222	MA201C103KAA
A2CR210	152-0321-00		SEMICONV DEVICE:SILICON,30V,0.1A	07263	FSA1480
A2CR220	152-0141-02		SEMICONV DVC,DI:SW,SI,30V,150MA,30V,DO-35	12969	NDP0263 (1N4152)
A2CR221	152-0141-02		SEMICONV DVC,DI:SW,SI,30V,150MA,30V,DO-35	12969	NDP0263 (1N4152)
A2CR256	152-0141-02		SEMICONV DVC,DI:SW,SI,30V,150MA,30V,DO-35	12969	NDP0263 (1N4152)
A2CR410	152-0321-00		SEMICONV DEVICE:SILICON,30V,0.1A	07263	FSA1480
A2CR420	152-0141-02		SEMICONV DVC,DI:SW,SI,30V,150MA,30V,DO-35	12969	NDP0263 (1N4152)
A2CR421	152-0141-02		SEMICONV DVC,DI:SW,SI,30V,150MA,30V,DO-35	12969	NDP0263 (1N4152)
A2CR456	152-0141-02		SEMICONV DVC,DI:SW,SI,30V,150MA,30V,DO-35	12969	NDP0263 (1N4152)
A2DS220	150-1000-00		LT EMITTING DIO:RED,650NM,40MA MAX	34430	MV-50
A2DS220	-----		(OPTION 06 ONLY)		
A2DS221	150-1000-00		LT EMITTING DIO:RED,650NM,40MA MAX	34430	MV-50
A2DS221	-----		(OPTION 06 ONLY)		
A2DS420	150-1000-00		LT EMITTING DIO:RED,650NM,40MA MAX	34430	MV-50
A2DS420	-----		(OPTION 06 ONLY)		
A2DS421	150-1000-00		LT EMITTING DIO:RED,650NM,40MA MAX	34430	MV-50
A2DS421	-----		(OPTION 06 ONLY)		
A2LR391	108-0184-00		COIL,RF:3.2UH(WOUND ON A 10 OHM RES	80009	108-0184-00
A2LR393	108-0184-00		COIL,RF:3.2UH(WOUND ON A 10 OHM RES	80009	108-0184-00
A2LR395	108-0184-00		COIL,RF:3.2UH(WOUND ON A 10 OHM RES	80009	108-0184-00
A2LR396	108-0184-00		COIL,RF:3.2UH(WOUND ON A 10 OHM RES	80009	108-0184-00
A2LR397	108-0184-00		COIL,RF:3.2UH(WOUND ON A 10 OHM RES	80009	108-0184-00
A2LR591	108-0184-00		COIL,RF:3.2UH(WOUND ON A 10 OHM RES	80009	108-0184-00
A2LR592	108-0184-00		COIL,RF:3.2UH(WOUND ON A 10 OHM RES	80009	108-0184-00
A2LR595	108-0184-00		COIL,RF:3.2UH(WOUND ON A 10 OHM RES	80009	108-0184-00
A2LR596	108-0184-00		COIL,RF:3.2UH(WOUND ON A 10 OHM RES	80009	108-0184-00
A2Q210	151-1032-00		TRANSISTOR:SILICON,FET,DUAL	17856	DN399
A2Q220	153-0631-00		SEMICONV DVC SE:SELECTED	80009	153-0631-00
A2Q225	151-0225-00		TRANSISTOR:SILICON,NPN	07263	S39291
A2Q240	153-0597-00		SEMICONV DVC SE:SILICON,PNP	80009	153-0597-00
A2Q245	153-0582-00		SEMICONV DVC SE:SILICON,FET,PAIR	22229	S2114
A2Q250	153-0597-00		SEMICONV DVC SE:SILICON,PNP	80009	153-0597-00

Component No.	Tektronix Part No.	Serial/Model No. Eff Dscont	Name & Description	Mfr Code	Mfr Part Number
A2Q260	151-0441-00		TRANSISTOR:SILICON,NPN	04713	SRF501
A2Q280	151-0221-00		TRANSISTOR:SILICON,PNP	04713	SPS246
A2Q320	153-0631-00		SEMICON DVC SE:SELECTED	80009	153-0631-00
A2Q325	151-0225-00		TRANSISTOR:SILICON,NPN	07263	S39291
A2Q340	153-0597-00		SEMICON DVC SE:SILICON,PNP	80009	153-0597-00
A2Q345	153-0582-00		SEMICON DVC SE:SILICON,FET,PAIR	22229	S2114
A2Q350	153-0597-00		SEMICON DVC SE:SILICON,PNP	80009	153-0597-00
A2Q360	151-0441-00		TRANSISTOR:SILICON,NPN	04713	SRF501
A2Q380	151-0221-00		TRANSISTOR:SILICON,PNP	04713	SPS246
A2Q410	151-1032-00		TRANSISTOR:SILICON,FET,DUAL	17856	DN399
A2Q420	153-0631-00		SEMICON DVC SE:SELECTED	80009	153-0631-00
A2Q425	153-0595-00		SEMICON DVC SE:SILICON,NPN	80009	153-0595-00
A2Q426	153-0595-00		SEMICON DVC SE:SILICON,NPN	80009	153-0595-00
A2Q440	153-0597-00		SEMICON DVC SE:SILICON,PNP	80009	153-0597-00
A2Q445	153-0582-00		SEMICON DVC SE:SILICON,FET,PAIR	22229	S2114
A2Q450	153-0597-00		SEMICON DVC SE:SILICON,PNP	80009	153-0597-00
A2Q460	151-0441-00		TRANSISTOR:SILICON,NPN	04713	SRF501
A2Q480	151-0221-00		TRANSISTOR:SILICON,PNP	04713	SPS246
A2Q520	153-0631-00		SEMICON DVC SE:SELECTED	80009	153-0631-00
A2Q525	153-0595-00		SEMICON DVC SE:SILICON,NPN	80009	153-0595-00
A2Q526	153-0595-00		SEMICON DVC SE:SILICON,NPN	80009	153-0595-00
A2Q540	153-0597-00		SEMICON DVC SE:SILICON,PNP	80009	153-0597-00
A2Q545	153-0582-00		SEMICON DVC SE:SILICON,FET,PAIR	22229	S2114
A2Q550	153-0597-00		SEMICON DVC SE:SILICON,PNP	80009	153-0597-00
A2Q560	151-0441-00		TRANSISTOR:SILICON,NPN	04713	SRF501
A2Q580	151-0221-00		TRANSISTOR:SILICON,PNP	04713	SPS246
A2R210	316-0474-00		RES.,FXD,CMPSN:470K OHM,10%,0.25W	01121	CB4741
A2R211	315-0470-00		RES.,FXD,CMPSN:47 OHM,5%,0.25W	57668	NTR25J-E47E0
A2R212	315-0561-00		RES.,FXD,CMPSN:560 OHM,5%,0.25W	57668	NTRERJ-E 560E
A2R215	315-0391-00		RES.,FXD,CMPSN:390 OHM,5%,0.25W	57668	NTR25J-E390E
A2R216	315-0911-00		RES.,FXD,CMPSN:910 OHM,5%,0.25W	57668	NTR25J-E910E
A2R218	321-0032-00		RES.,FXD,FILM:21 OHM,1%,0.125W	91637	MFF1816G21R00F
A2R222	321-0153-00		RES.,FXD,FILM:383 OHM,1%,0.125W	91637	CMF55116G383R0F
A2R223	323-0257-00		RES.,FXD,FILM:4.64K OHM,1%,0.50W	91637	MFF1226G46400F
A2R224	321-0032-00		RES.,FXD,FILM:21 OHM,1%,0.125W	91637	MFF1816G21R00F
A2R225	315-0621-00		RES.,FXD,CMPSN:620 OHM,5%,0.25W	57668	NTR25J-E620E
A2R226	321-0122-00		RES.,FXD,FILM:182 OHM,1%,0.125W	91637	CMF55116G182R0F
A2R227	315-0561-00		RES.,FXD,CMPSN:560 OHM,5%,0.25W	57668	NTRERJ-E 560E
A2R236	315-0242-00		RES.,FXD,CMPSN:2.4K OHM,5%,0.25W	57668	NTR25J-E02K4
A2R240	321-0356-00		RES.,FXD,FILM:49.9K OHM,1%,0.125W	91637	MFF1816G49901F
A2R241	315-0221-00		RES.,FXD,CMPSN:220 OHM,5%,0.25W	57668	NTR25J-E220E
A2R242	321-0068-00		RES.,FXD,FILM:49.9 OHM,1%,0.125W	91637	CMF55116G49R90F
A2R243	323-0255-00		RES.,FXD,FILM:4.42K OHM,1%,0.50W	75042	CECT0-4421F
A2R244	321-0126-00		RES.,FXD,FILM:200 OHM,1%,0.125W	91637	CMF55116G200R0F
A2R245	311-0634-00		RES.,VAR, NONWIR: TRMR, 500 OHM, 0.5W	32997	3329H-L58-501
A2R246	315-0912-00		RES.,FXD,CMPSN:9.1K OHM,5%,0.25W	57668	NTR25J-E09K1
A2R246	-----		(NOMINAL VALUE SELECTED, 4.7K-100K MAX)		
A2R249	315-0203-00		RES.,FXD,CMPSN:20K OHM,5%,0.25W	57668	NTR25J-E20K0
A2R250	321-0105-00		RES.,FXD,FILM:121 OHM,1%,0.125W	91637	CMF55116G121R0F
A2R251	321-0137-00		RES.,FXD,FILM:261 OHM,1%,0.125W	91637	MFF1816G261R0F
A2R256	315-0471-00		RES.,FXD,CMPSN:470 OHM,5%,0.25W	57668	NTR25J-E470E
A2R257	315-0153-00		RES.,FXD,CMPSN:15K OHM,5%,0.25W	57668	NTR25J-E 15K
A2R259	315-0103-00		RES.,FXD,CMPSN:10K OHM,5%,0.25W	57668	NTR25J-E10K0
A2R260	315-0101-00		RES.,FXD,CMPSN:100 OHM,5%,0.25W	57668	NTR25J-E 100E

Replaceable Electrical Parts—7A18A

Component No.	Tektronix Part No.	Serial/Model No. Eff Dscnt	Name & Description	Mfr Code	Mfr Part Number
A2R263	315-0272-00		RES.,FXD,CMPSN:2.7K OHM,5%,0.25W	57668	NTR25J-E02K7
A2R264	315-0330-00		RES.,FXD,CMPSN:33 OHM,5%,0.25W	57668	NTR25J-E 33E
A2R274	315-0242-00		RES.,FXD,CMPSN:2.4K OHM,5%,0.25W	57668	NTR25J-E02K4
A2R275	315-0100-00		RES.,FXD,CMPSN:10 OHM,5%,0.25W	57668	NTR25J-E 10E0
A2R276	321-0059-00		RES.,FXD,FILM:40.2 OHM,1%,0.125W	91637	CMF55116G50R20F
A2R277	321-0059-00		RES.,FXD,FILM:40.2 OHM,1%,0.125W	91637	CMF55116G50R20F
A2R278	323-0189-00		RES.,FXD,FILM:909 OHM,1%,0.50W	24546	NA65 9090F
A2R280	315-0330-00		RES.,FXD,CMPSN:33 OHM,5%,0.25W	57668	NTR25J-E 33E
A2R282	323-0150-00		RES.,FXD,FILM:357 OHM,1%,0.50W	91637	MFF1226G357R0F
A2R286	323-0206-00		RES.,FXD,FILM:1.37K OHM,1%,0.50W	75042	CECT0-1371F
A2R313	315-0105-00		RES.,FXD,CMPSN:1M OHM,5%,0.25W	57668	NTR255-E 1M
A2R317	321-0032-00		RES.,FXD,FILM:21 OHM,1%,0.125W	91637	MFF1816G21R00F
A2R318	315-0911-00		RES.,FXD,CMPSN:910 OHM,5%,0.25W	57668	NTR25J-E910E
A2R319	315-0391-00		RES.,FXD,CMPSN:390 OHM,5%,0.25W	57668	NTR25J-E390E
A2R320	315-0152-00		RES.,FXD,CMPSN:1.5K OHM,5%,0.25W	57668	NTR25J-E01K5
A2R321	311-0633-00		RES.,VAR,NONWIR:5K OHM,10%,0.50W	73138	82PR5K-30C
A2R322	315-0133-00		RES.,FXD,CMPSN:13K OHM,5%,0.25W	57668	NTR25J-E 13K
A2R323	315-0131-00		RES.,FXD,CMPSN:130 OHM,5%,0.25W	57668	NTR25J-E 130E
A2R324	321-0032-00		RES.,FXD,FILM:21 OHM,1%,0.125W	91637	MFF1816G21R00F
A2R325	315-0621-00		RES.,FXD,CMPSN:620 OHM,5%,0.25W	57668	NTR25J-E620E
A2R326	321-0122-00		RES.,FXD,FILM:182 OHM,1%,0.125W	91637	CMF55116G182R0F
A2R327	315-0431-00		RES.,FXD,CMPSN:430 OHM,5%,0.25W	57668	NTR25J-E 430E
A2R340	321-0356-00		RES.,FXD,FILM:49.9K OHM,1%,0.125W	91637	MFF1816G49901F
A2R341	315-0221-00		RES.,FXD,CMPSN:220 OHM,5%,0.25W	57668	NTR25J-E220E
A2R342	321-0068-00		RES.,FXD,FILM:49.9 OHM,1%,0.125W	91637	CMF55116G49R90F
A2R343	323-0255-00		RES.,FXD,FILM:4.42K OHM,1%,0.50W	75042	CECT0-4421F
A2R345	315-0363-00		RES.,FXD,CMPSN:36K OHM,5%,0.25W	57668	NTR25J-E36K0
A2R350	323-0153-00		RES.,FXD,FILM:383 OHM,1%,0.50W	24546	NA65D3830F
A2R351	321-0137-00		RES.,FXD,FILM:261 OHM,1%,0.125W	91637	MFF1816G261R0F
A2R351	321-0137-00		RES.,FXD,FILM:261 OHM,1%,0.125W	91637	MFF1816G261R0F
A2R356	315-0471-00		RES.,FXD,CMPSN:470 OHM,5%,0.25W	57668	NTR25J-E470E
A2R357	315-0204-00		RES.,FXD,CMPSN:200K OHM,5%,0.25W	57668	NTR25J-E 200K
A2R359	315-0122-00		RES.,FXD,CMPSN:1.2K OHM,5%,0.25W	57668	NTR25J-E01K2
A2R363	315-0272-00		RES.,FXD,CMPSN:2.7K OHM,5%,0.25W	57668	NTR25J-E02K7
A2R364	315-0330-00		RES.,FXD,CMPSN:33 OHM,5%,0.25W	57668	NTR25J-E 33E
A2R370	321-0217-00		RES.,FXD,FILM:1.78K OHM,1%,0.125W	91637	CMF55116G17800F
A2R374	315-0242-00		RES.,FXD,CMPSN:2.4K OHM,5%,0.25W	57668	NTR25J-E02K4
A2R375	315-0100-00		RES.,FXD,CMPSN:10 OHM,5%,0.25W	57668	NTR25J-E 10E0
A2R376	321-0059-00		RES.,FXD,FILM:40.2 OHM,1%,0.125W	91637	CMF55116G50R20F
A2R377	321-0059-00		RES.,FXD,FILM:40.2 OHM,1%,0.125W	91637	CMF55116G50R20F
A2R378	323-0189-00		RES.,FXD,FILM:909 OHM,1%,0.50W	24546	NA65 9090F
A2R380	315-0330-00		RES.,FXD,CMPSN:33 OHM,5%,0.25W	57668	NTR25J-E 33E
A2R382	323-0150-00		RES.,FXD,FILM:357 OHM,1%,0.50W	91637	MFF1226G357R0F
A2R384	315-0271-00		RES.,FXD,CMPSN:270 OHM,5%,0.25W	01121	CB2715
A2R386	323-0206-00		RES.,FXD,FILM:1.37K OHM,1%,0.50W	75042	CECT0-1371F
A2R390	315-0470-00		RES.,FXD,CMPSN:47 OHM,5%,0.25W	57668	NTR25J-E47E0
A2R400	315-0152-00		RES.,FXD,CMPSN:1.5K OHM,5%,0.25W	57668	NTR25J-E01K5
A2R401	315-0101-00		RES.,FXD,CMPSN:100 OHM,5%,0.25W	57668	NTR25J-E 100E
A2R410	316-0474-00		RES.,FXD,CMPSN:470K OHM,10%,0.25W	01121	CB4741
A2R411	315-0470-00		RES.,FXD,CMPSN:47 OHM,5%,0.25W	57668	NTR25J-E47E0
A2R412	315-0561-00		RES.,FXD,CMPSN:560 OHM,5%,0.25W	57668	NTRERJ-E 560E
A2R415	315-0391-00		RES.,FXD,CMPSN:390 OHM,5%,0.25W	57668	NTR25J-E390E
A2R416	315-0911-00		RES.,FXD,CMPSN:910 OHM,5%,0.25W	57668	NTR25J-E910E
A2R418	321-0032-00		RES.,FXD,FILM:21 OHM,1%,0.125W	91637	MFF1816G21R00F

Component No.	Tektronix Part No.	Serial/Model No. Eff Dscnt	Name & Description	Mfr Code	Mfr Part Number
A2R422	321-0153-00		RES.,FXD,FILM:383 OHM,1%,0.125W	91637	CMF55116G383R0F
A2R423	323-0257-00		RES.,FXD,FILM:4.64K OHM,1%,0.50W	91637	MFF1226G46400F
A2R424	321-0032-00		RES.,FXD,FILM:21 OHM,1%,0.125W	91637	MFF1816G21R00F
A2R425	315-0621-00		RES.,FXD,CMPSN:620 OHM,5%,0.25W	57668	NTR25J-E620E
A2R426	321-0122-00		RES.,FXD,FILM:182 OHM,1%,0.125W	91637	CMF55116G182R0F
A2R427	315-0561-00		RES.,FXD,CMPSN:560 OHM,5%,0.25W	57668	NTRERJ-E 560E
A2R428	315-0301-00		RES.,FXD,CMPSN:300 OHM,5%,0.25W	57668	NTR25J-E300E
A2R429	315-0561-00		RES.,FXD,CMPSN:560 OHM,5%,0.25W	57668	NTRERJ-E 560E
A2R436	315-0242-00		RES.,FXD,CMPSN:2.4K OHM,5%,0.25W	57668	NTR25J-E02K4
A2R440	321-0303-00		RES.,FXD,FILM:49.9K OHM,1%,0.125W	91637	MFF1816G49901F
A2R441	315-0221-00		RES.,FXD,CMPSN:220 OHM,5%,0.25W	57668	NTR25J-E220E
A2R442	321-0068-00		RES.,FXD,FILM:49.9 OHM,1%,0.125W	91637	CMF55116G49R90F
A2R443	323-0255-00		RES.,FXD,FILM:4.42K OHM,1%,0.50W	75042	CECT0-4421F
A2R444	321-0126-00		RES.,FXD,FILM:200 OHM,1%,0.125W	91637	CMF55116G200R0F
A2R445	311-0634-00		RES.,VAR, NONWIR:TRMR,500 OHM,0.5W	32997	3329H-L58-501
A2R446	315-0363-00		RES.,FXD,CMPSN:36K OHM,5%,0.25W	57668	NTR25J-E36K0
A2R449	315-0203-00		RES.,FXD,CMPSN:20K OHM,5%,0.25W	57668	NTR25J-E20K0
A2R450	321-0110-00		RES.,FXD,FILM:137 OHM,1%,0.125W	91637	CMF55116G137R0F
A2R451	321-0137-00		RES.,FXD,FILM:261 OHM,1%,0.125W	91637	MFF1816G261R0F
A2R455	315-0272-00		RES.,FXD,CMPSN:2.7K OHM,5%,0.25W	57668	NTR25J-E02K7
A2R456	315-0471-00		RES.,FXD,CMPSN:470 OHM,5%,0.25W	57668	NTR25J-E470E
A2R459	315-0103-00		RES.,FXD,CMPSN:10K OHM,5%,0.25W	57668	NTR25J-E10K0
A2R460	315-0101-00		RES.,FXD,CMPSN:100 OHM,5%,0.25W	57668	NTR25J-E 100E
A2R463	315-0272-00		RES.,FXD,CMPSN:2.7K OHM,5%,0.25W	57668	NTR25J-E02K7
A2R464	315-0330-00		RES.,FXD,CMPSN:33 OHM,5%,0.25W	57668	NTR25J-E 33E
A2R474	315-0182-00		RES.,FXD,CMPSN:1.8K OHM,5%,0.25W	57668	NTR25J-E1K8
A2R476	321-0059-00		RES.,FXD,FILM:40.2 OHM,1%,0.125W	91637	CMF55116G50R20F
A2R477	321-0059-00		RES.,FXD,FILM:40.2 OHM,1%,0.125W	91637	CMF55116G50R20F
A2R478	323-0189-00		RES.,FXD,FILM:909 OHM,1%,0.50W	24546	NA65 9090F
A2R480	315-0330-00		RES.,FXD,CMPSN:33 OHM,5%,0.25W	57668	NTR25J-E 33E
A2R482	323-0150-00		RES.,FXD,FILM:357 OHM,1%,0.50W	91637	MFF1226G357R0F
A2R484	315-0331-00		RES.,FXD,CMPSN:330 OHM,5%,0.25W	57668	NTR25J-E330E
A2R486	323-0206-00		RES.,FXD,FILM:1.37K OHM,1%,0.50W	75042	CECT0-1371F
A2R513	315-0105-00		RES.,FXD,CMPSN:1M OHM,5%,0.25W	57668	NTR255-E 1M
A2R517	321-0032-00		RES.,FXD,FILM:21 OHM,1%,0.125W	91637	MFF1816G21R00F
A2R518	315-0911-00		RES.,FXD,CMPSN:910 OHM,5%,0.25W	57668	NTR25J-E910E
A2R519	315-0391-00		RES.,FXD,CMPSN:390 OHM,5%,0.25W	57668	NTR25J-E390E
A2R520	315-0152-00		RES.,FXD,CMPSN:1.5K OHM,5%,0.25W	57668	NTR25J-E01K5
A2R521	311-0633-00		RES.,VAR, NONWIR:5K OHM,10%,0.50W	73138	82PR5K-30C
A2R522	315-0133-00		RES.,FXD,CMPSN:13K OHM,5%,0.25W	57668	NTR25J-E 13K
A2R523	315-0131-00		RES.,FXD,CMPSN:130 OHM,5%,0.25W	57668	NTR25J-E 130E
A2R524	321-0032-00		RES.,FXD,FILM:21 OHM,1%,0.125W	91637	MFF1816G21R00F
A2R525	315-0621-00		RES.,FXD,CMPSN:620 OHM,5%,0.25W	57668	NTR25J-E620E
A2R526	321-0122-00		RES.,FXD,FILM:182 OHM,1%,0.125W	91637	CMF55116G182R0F
A2R527	315-0751-00		RES.,FXD,CMPSN:750 OHM,5%,0.25W	57668	NTR25J-E750E
A2R529	315-0751-00		RES.,FXD,CMPSN:750 OHM,5%,0.25W	57668	NTR25J-E750E
A2R540	321-0356-00		RES.,FXD,FILM:49.9K OHM,1%,0.125W	91637	MFF1816G49901F
A2R541	315-0221-00		RES.,FXD,CMPSN:220 OHM,5%,0.25W	57668	NTR25J-E220E
A2R542	321-0071-00		RES.,FXD,FILM:53.6 OHM,1%,0.125W	91637	MFF1816G53R60F
A2R543	323-0255-00		RES.,FXD,FILM:4.42K OHM,1%,0.50W	75042	CECT0-4421F
A2R544	311-0609-00		RES.,VAR, NONWIR:2K OHM,10%,0.50W	73138	82-26-1
A2R545	315-0912-00		RES.,FXD,CMPSN:9.1K OHM,5%,0.25W	57668	NTR25J-E09K1
A2R545	-----		(NOMINAL VALUE SELECTED,4.7K-100K MAX)		
A2R549	315-0123-00		RES.,FXD,CMPSN:12K OHM,5%,0.25W	57668	NTR25J-E12K0

Replaceable Electrical Parts—7A18A

Component No.	Tektronix Part No.	Serial/Model No. Eff Dscont	Name & Description	Mfr Code	Mfr Part Number
A2R550	323-0153-00		RES.,FXD,FILM:383 OHM,1%,0.50W	24546	NA65D383OF
A2R551	321-0137-00		RES.,FXD,FILM:261 OHM,1%,0.125W	91637	MFF1816G261R0F
A2R555	315-0272-00		RES.,FXD,CMPSN:2.7K OHM,5%,0.25W	57668	NTR25J-E02K7
A2R556	315-0471-00		RES.,FXD,CMPSN:470 OHM,5%,0.25W	57668	NTR25J-E470E
A2R557	315-0204-00		RES.,FXD,CMPSN:200K OHM,5%,0.25W	57668	NTR25J-E 200K
A2R559	315-0122-00		RES.,FXD,CMPSN:1.2K OHM,5%,0.25W	57668	NTR25J-E01K2
A2R563	315-0272-00		RES.,FXD,CMPSN:2.7K OHM,5%,0.25W	57668	NTR25J-E02K7
A2R564	315-0330-00		RES.,FXD,CMPSN:33 OHM,5%,0.25W	57668	NTR25J-E 33E
A2R570	321-0217-00		RES.,FXD,FILM:1.78K OHM,1%,0.125W	91637	CMF55116G17800F
A2R574	315-0182-00		RES.,FXD,CMPSN:1.8K OHM,5%,0.25W	57668	NTR25J-E1K8
A2R576	321-0059-00		RES.,FXD,FILM:40.2 OHM,1%,0.125W	91637	CMF55116G50R20F
A2R577	321-0059-00		RES.,FXD,FILM:40.2 OHM,1%,0.125W	91637	CMF55116G50R20F
A2R578	323-0189-00		RES.,FXD,FILM:909 OHM,1%,0.50W	24546	NA65 9090F
A2R580	315-0330-00		RES.,FXD,CMPSN:33 OHM,5%,0.25W	57668	NTR25J-E 33E
A2R582	323-0150-00		RES.,FXD,FILM:357 OHM,1%,0.50W	91637	MFF1226G357R0F
A2R584	315-0331-00		RES.,FXD,CMPSN:330 OHM,5%,0.25W	57668	NTR25J-E330E
A2R586	323-0206-00		RES.,FXD,FILM:1.37K OHM,1%,0.50W	75042	CECT0-1371F
A2R590	315-0470-00		RES.,FXD,CMPSN:47 OHM,5%,0.25W	57668	NTR25J-E47E0
A2U270	155-0022-00		MICROCIRCUIT,DI:ML,CHANNEL SWITCH	80009	155-0022-00
A2U470	155-0022-00		MICROCIRCUIT,DI:ML,CHANNEL SWITCH	80009	155-0022-00
A2W391	131-0566-00		BUS CONDUCTOR:DUMMY RES,2.375,22 AWG	57668	JWW-0200E0
A2W393	131-0566-00		BUS CONDUCTOR:DUMMY RES,2.375,22 AWG	57668	JWW-0200E0
A2W591	131-0566-00		BUS CONDUCTOR:DUMMY RES,2.375,22 AWG	57668	JWW-0200E0
A2W593	131-0566-00		BUS CONDUCTOR:DUMMY RES,2.375,22 AWG	57668	JWW-0200E0

Component No.	Tektronix Part No.	Serial/Model No. Eff	Dscont	Name & Description	Mfr Code	Mfr Part Number
CHASSIS PARTS						
AT106	307-1010-01			ATTENUATOR,FXD:2X	80009	307-1010-01
AT110	307-1011-00			ATTENUATOR,FXD:4X	80009	307-1011-00
AT114	307-1013-01			ATTENUATOR,FXD:10X	80009	307-1013-01
AT118	307-1014-01			ATTENUATOR,FXD:100X	80009	307-1014-01
C9	283-0000-00			CAP.,FXD,CER DI:0.001UF,+100-0%,500V	59660	831610Y5U0102P
C10	285-0816-01	B010100	B011884	CAP.,FXD,PLSTC:0.019UF,10%,600V	80009	285-0816-01
C10	285-1132-00	B011885		CAP.,FXD,PLSTC:0.019UF,10%,600V	80009	285-1132-00
C13	283-0000-00			CAP.,FXD,CER DI:0.001UF,+100-0%,500V	59660	831610Y5U0102P
C19	283-0000-00			CAP.,FXD,CER DI:0.001UF,+100-0%,500V	59660	831610Y5U0102P
C20	285-0816-01	B010100	B011884	CAP.,FXD,PLSTC:0.019UF,10%,600V	80009	285-0816-01
C20	285-1132-00	B011885		CAP.,FXD,PLSTC:0.019UF,10%,600V	80009	285-1132-00
C23	283-0000-00			CAP.,FXD,CER DI:0.001UF,+100-0%,500V	59660	831610Y5U0102P
C49	283-0003-00			CAP.,FXD,CER DI:0.01UF,+80-20%,150V	59821	D103Z40Z5UJDC EX
J10	131-0679-02			CONNECTOR,RCPT,;BNC,MALE,3 CONTACT	24931	28JR270-1
J20	131-0679-02			CONNECTOR,RCPT,;BNC,MALE,3 CONTACT	24931	28JR270-1
R10	317-0620-02			RES.,FXD,CMPSN:62 OHM,5%,0.125W	80009	317-0620-02
R11	311-1320-00			RES.,VAR,NONWIR:5K OHM,1W,W/SW	12697	381CM-39700
R11	311-1144-00			RES.,VAR,NONWIR:	12697	381CM40360
R11	-----			(OPTION 06 ONLY)		
R12	311-0889-00			RES.,VAR,WW:PNL,5K OHM,1W	02111	162-214
R12	-----			(OPTION 06 ONLY)		
R13	317-0910-00			RES.,FXD,CMPSN:91 OHM,5%,0.125W	01121	BB9105
R20	317-0620-02			RES.,FXD,CMPSN:62 OHM,5%,0.125W	80009	317-0620-02
R21	311-1320-00			RES.,VAR,NONWIR:5K OHM,1W,W/SW	12697	381CM-39700
R21	311-1144-00			RES.,VAR,NONWIR:	12697	381CM40360
R21	-----			(OPTION 06 ONLY)		
R22	311-0889-00			RES.,VAR,WW:PNL,5K OHM,1W	02111	162-214
R22	-----			(OPTION 06 ONLY)		
R23	317-0910-00			RES.,FXD,CMPSN:91 OHM,5%,0.125W	01121	BB9105
R35	315-0241-00			RES.,FXD,CMPSN:240 OHM,5%,0.25W	57668	NTR25J-E 240E
R36	315-0621-00			RES.,FXD,CMPSN:620 OHM,5%,0.25W	57668	NTR25J-E620E
R38	315-0392-00			RES.,FXD,CMPSN:3.9K OHM,5%,0.25W	57668	NTR25J-E03K9
S13	-----			(PART OF R11)		
S22	260-1833-00			SWITCH,SLIDE:DPDT	82389	11P-1092
S23	-----			(PART OF R21)		
S30	262-1024-00			SWITCH ASSY:ATTENUATOR	80009	262-1024-00
T11	276-0525-00			CORE,FERRITE:0.196 ID X 0.437"OD	01121	T037C351A
T21	276-0525-00			CORE,FERRITE:0.196 ID X 0.437"OD	01121	T037C351A
T31	276-0525-00			CORE,FERRITE:0.196 ID X 0.437"OD	01121	T037C351A



DIAGRAMS AND CIRCUIT BOARD ILLUSTRATIONS

Symbols

Graphic symbols and class designation letters are based on ANSI Standard Y32.2-1975.

Logic symbology is based on ANSI Y32.14-1973 in terms of positive logic. Logic symbols depict the logic function performed and may differ from the manufacturer's data.

The overline on a signal name indicates that the signal performs its intended function when it is in the low state.

Abbreviations are based on ANSI Y1.1-1972.

Other ANSI standards that are used in the preparation of diagrams by Tektronix, Inc. are:

- Y14.15, 1966 Drafting Practices.
- Y14.2, 1973 Line Conventions and Lettering.
- Y10.5, 1968 Letter Symbols for Quantities Used in Electrical Science and Electrical Engineering.

American National Standard Institute
1430 Broadway
New York, New York 10018

Component Values

Electrical components shown on the diagrams are in the following units unless noted otherwise:

- Capacitors = Values one or greater are in picofarads (pF). Values less than one are in microfarads (μ F).
- Resistors = Ohms (Ω).

———— The information and special symbols below may appear in this manual. ————

Assembly Numbers and Grid Coordinates

Each assembly in the instrument is assigned an assembly number (e.g., A20). The assembly number appears on the circuit board outline on the diagram, in the title for the circuit board component location illustration, and in the lookup table for the schematic diagram and corresponding component locator illustration. The Replaceable Electrical Parts list is arranged by assemblies in numerical sequence; the components are listed by component number *(see following illustration for constructing a component number).

The schematic diagram and circuit board component location illustration have grids. A lookup table with the grid coordinates is provided for ease of locating the component. Only the components illustrated on the facing diagram are listed in the lookup table. When more than one schematic diagram is used to illustrate the circuitry on a circuit board, the circuit board illustration may only appear opposite the first diagram on which it was illustrated; the lookup table will list the diagram number of other diagrams that the circuitry of the circuit board appears on.

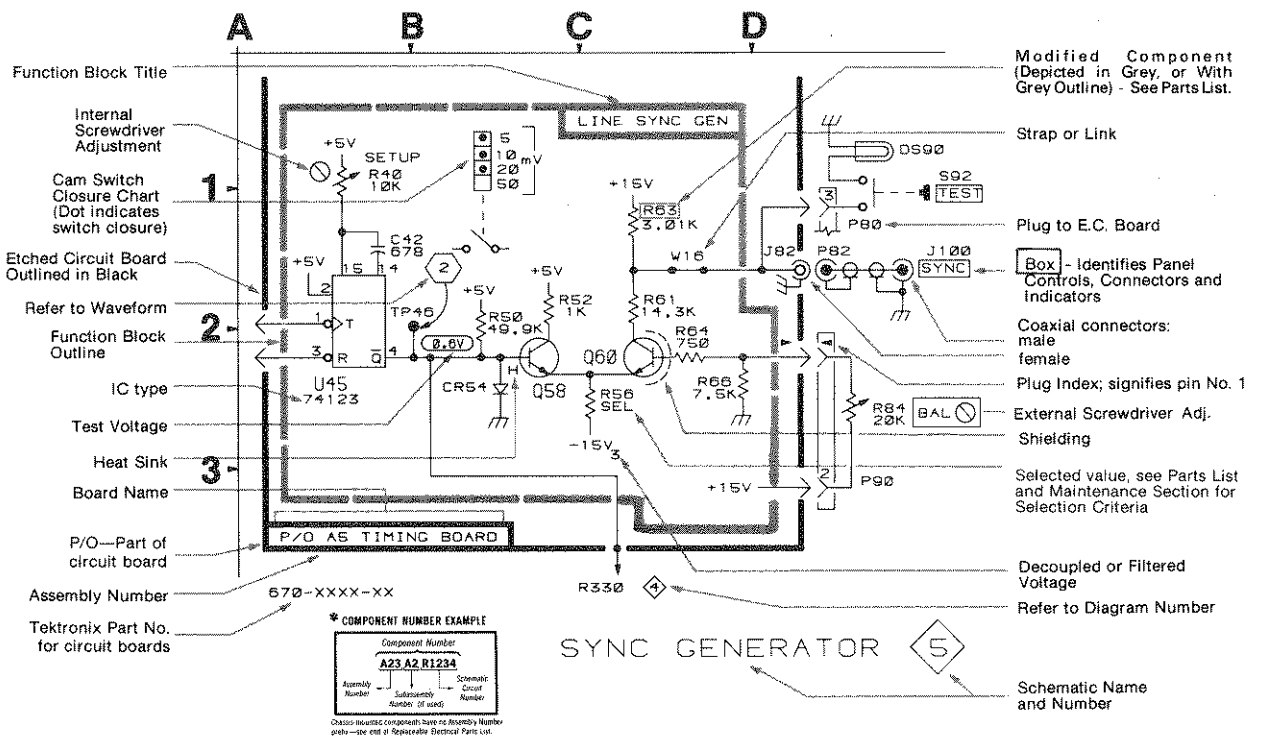

VOLTAGE AND WAVEFORM TEST CONDITIONS

Typical voltage measurements were obtained under the following conditions unless noted otherwise on the individual diagrams:

Voltmeter

Type	Non-loading digital multimeter
Input impedance	10 MΩ
Range	0 to 1000 volts
Recommended type (as used for voltages on diagrams)	Tektronix 7D13A Digital Multimeter

7A18A (left vertical compartment)

DISPLAY MODE	ALT
TRIGGER SOURCE	MODE
CH 2 POLARITY	+UP

CH 1 and CH 2

VOLTS/DIV	10 mV
COUPLING	DC
POSITION	Centered
VARIABLE	CAL IN
Signal Applied	No signal for voltage measurements, 40 mV square wave from oscilloscope Calibrator applied to both input connectors for waveforms.

7A16A (right vertical compartment using a 10X probe with readout coding ring. P6053B probe used for waveforms on diagrams)

Polarity	+UP
Bandwidth	Full
Position	Centered
Coupling	AC
Variable	Cal In

7B80 (A Horizontal compartment)

Level/Slope	Centered on positive slope
Triggering Mode	P-P Auto
Coupling	AC
Source	Ext
Magnifier	X1
Time/Div	1 ms
Variable	Cal In
Ext Trig In connector	No connection for voltage measurements. For waveforms Sig Out from oscilloscope connected to Ext Trig In connector.

7704A

Vertical Mode	Right
Horizontal Mode	A
A Intensity	Optimum
B Intensity	Counterclockwise
Calibrator	
Volts	40 mV
Rate	1 kHz
A Trigger Source	Right Vert
B Trigger Source	Left Vert

All voltages given on the diagrams are in volts. All currents are in milliamps. Waveforms shown are actual waveform photographs taken with a Tektronix Oscilloscope Camera System. Vertical deflection factor shown on waveform is the actual deflection factor from the probe tip. Voltages and waveforms on the diagrams (shown in grey) are not absolute and may vary between instruments because of component tolerances, internal calibration or front panel settings. Readouts are simulated in larger-than-normal type.

NOTE

The spring tension of the pin sockets ensures a good connection between the circuit board and pin. This spring tension may be damaged by using the pin sockets as a connecting point for spring-loaded probe tips, alligator clips, etc.

BLOCK DIAGRAM

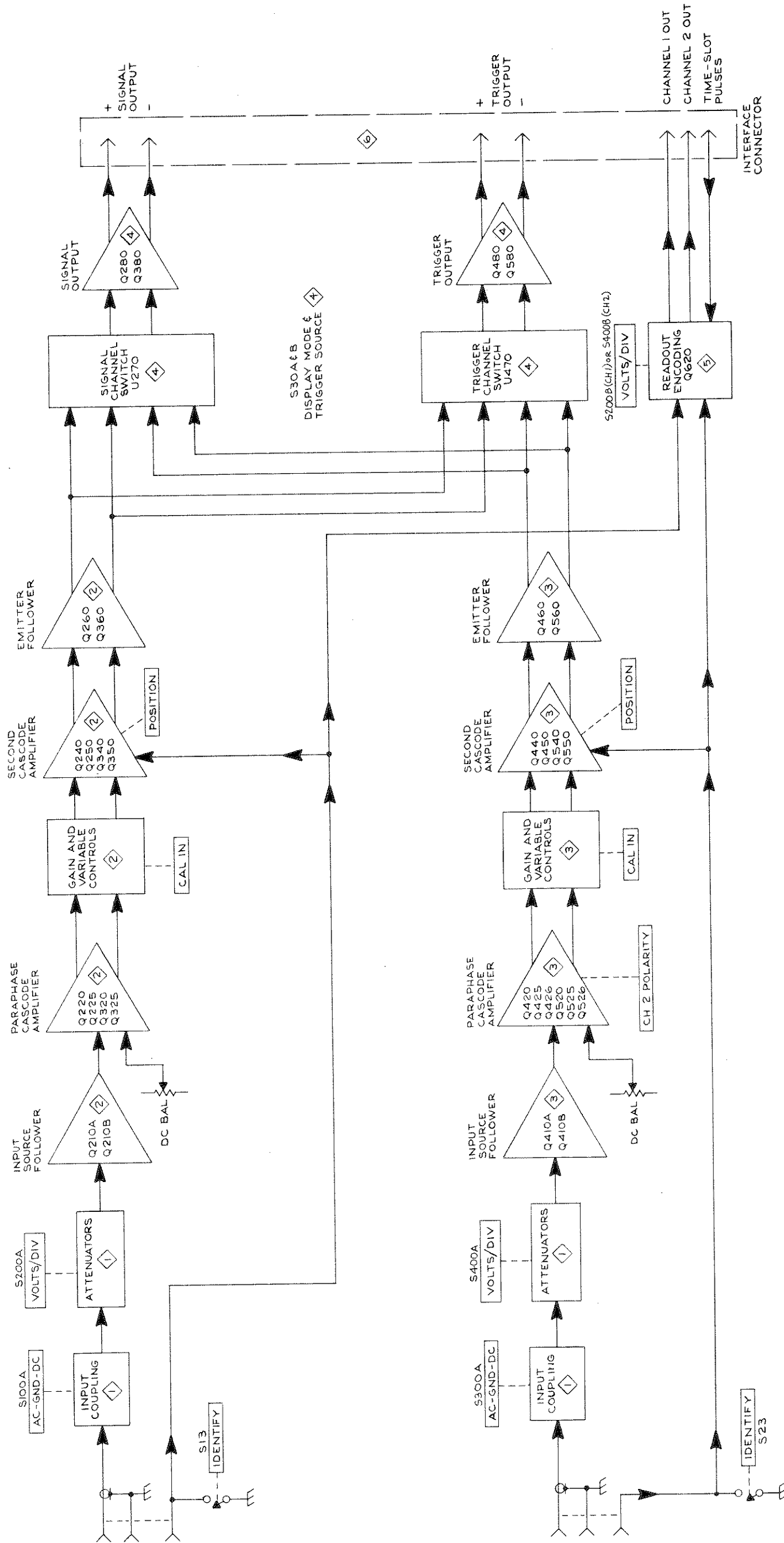

BLOCK DIAGRAM

(1126) 4329-19

7A18A

P/O A2 ASSY			CH 1 Input Ampl		
Circuit Number	Schematic Location	Board Location	Circuit Number	Schematic Location	Board Location
C210	A2	H2	R222	E5	G3
C212	B3	H2	R223	C5	G1
C216	B2	H3	R224	C4	G2
C225	C2	G2	R226	E3	G2
C241	F2	E2	R227	D6	G2
C245	E5	F2	R236	E5	F2
C246	F5	F2	R240	F4	E2
C256	K3	E1	R241	F3	E2
C257	J6	D1	R242	G2	E2
C264	L3	D2	R243	F3	F2
C313	B4	G2	R244	F5	F2
C318	B4	G3	R245	E4	F2
C325	D7	G1	R246	F4	F1
C345	F5	F1	R249	G4	F2
C356	K7	D1	R250	L5	E3
C364	L7	D2	R251	K3	E2
			R256	L3	E2
CR210	B3	G3	R257	J6	E1
CR220	C3	G2	R259	L5	G1
CR221	C3	G2	R260	L5	D2
CR256	K2	E2	R263	L2	D2
			R264	B3	G3
P245	F2	F2	R313	C3	G3
P257	E1	F2	R317	C4	G2
P258	F2	F2	R318	C4	G2
			R319	C4	G2
Q210A	C2	G2	R320	B7	G1
Q210B	C3	G2	R321	B8	F3
Q225	D2	G2	R322	C7	G1
Q240	F2	F2	R323	C8	G1
Q245	G4	F2	R324	C6	G1
Q250	L2	E2	R325	D7	G1
Q260	L3	D2	R326	E6	G2
Q320	C7	G1	R327	D5	G2
Q325	D7	G1	R340	F5	E1
Q340	F7	F1	R341	F7	E1
Q345	G4	F1	R342	G7	E1
Q350	K7	E2	R343	F7	E1
Q360	L7	D2	R345	F5	F1
			R350	L5	E2
R210	A2	H2	R351	L6	E1
R211	B2	H2	R356	K7	E1
R212	B2	H2	R357	K2	E2
R215	C2	G3	R359	L5	E2
R216	C2	G2	R363	L7	D1
R218	B2	G2	R364	L7	D1

P/O A2 ASSY also shown on 3, 4, 6 & 7

P/O A1A3 ASSY

P/O A1A3 ASSY			CH 1 Input Ampl		
Circuit Number	Schematic Location	Board Location	Circuit Number	Schematic Location	Board Location
P675	H3	H1	R675	H5	G1
R660	J3	H1	R676	H5	H1
R661	J3	K1	R677	H5	G1
R663	J3	H1	R679	J5	H1
R665	H3	H1	R681	J5	H1
R666	J3	H1	S667	H4	J1
R668	J4	H1	U675A	J4	G1
R670	J4	H1	U675B	J5	G1
R672	J4	H1			

P/O A1A3 ASSY also shown on 3 & 6

A2-AMPLIFIER CIRCUIT BOARD

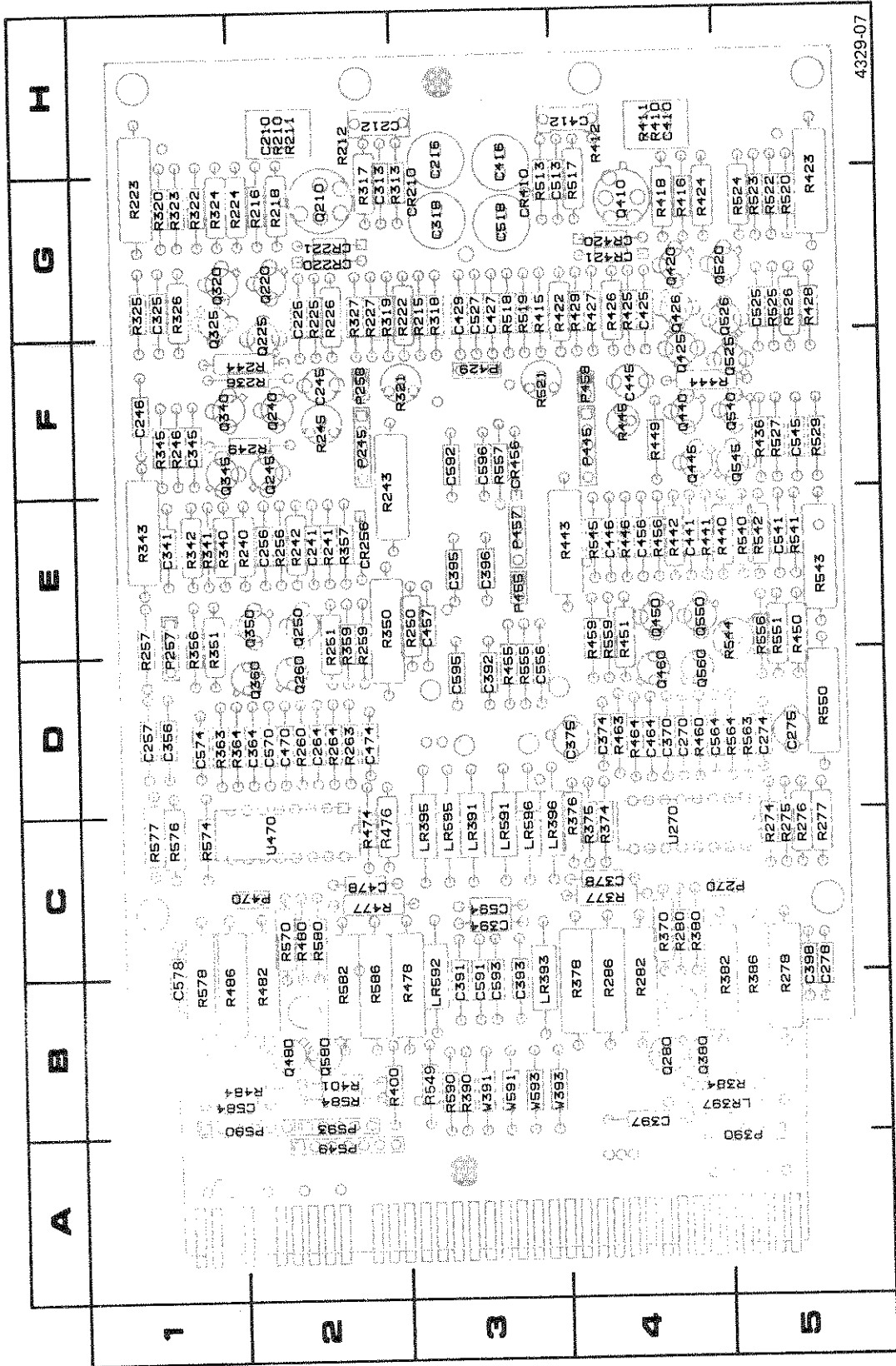
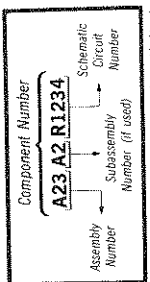

Fig. 8-1. Amplifier Circuit Board Assembly.

Static Sensitive Devices
See Maintenance Section

COMPONENT NUMBER EXAMPLE



TEST WAVEFORMS FOR DIAGRAM

2

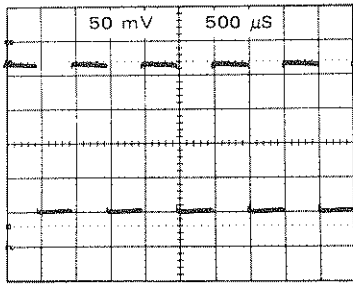

1

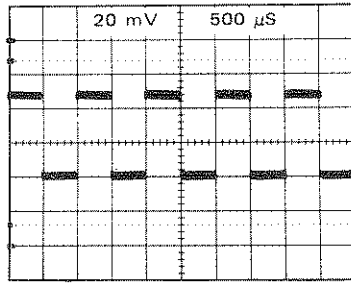

2

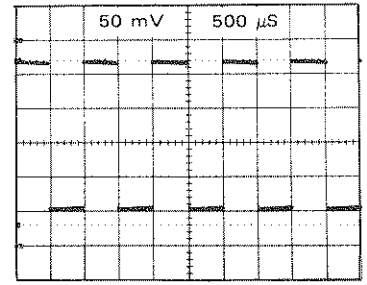

3

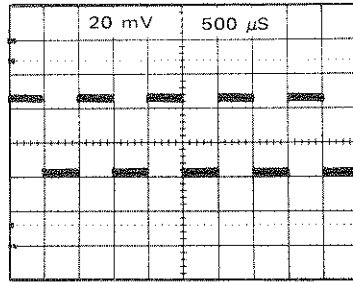

4

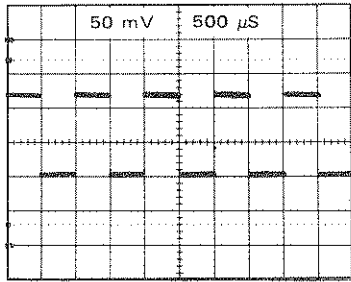

5

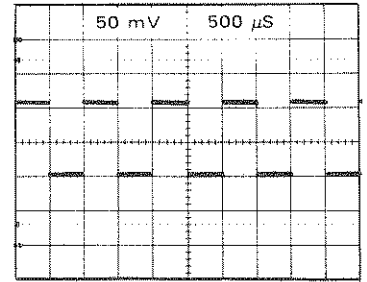

6

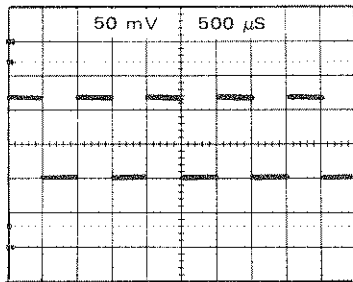

7

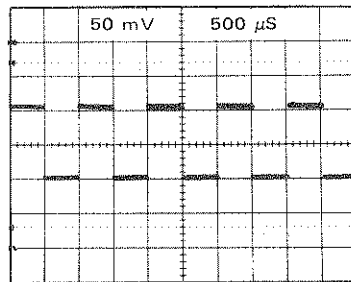

8

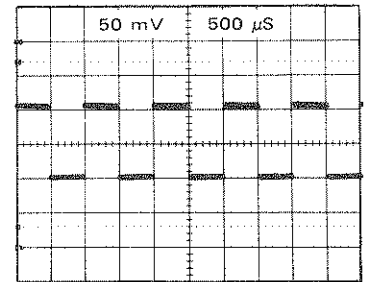

9

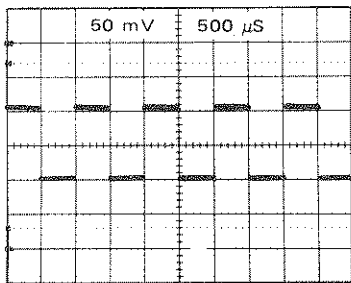

10



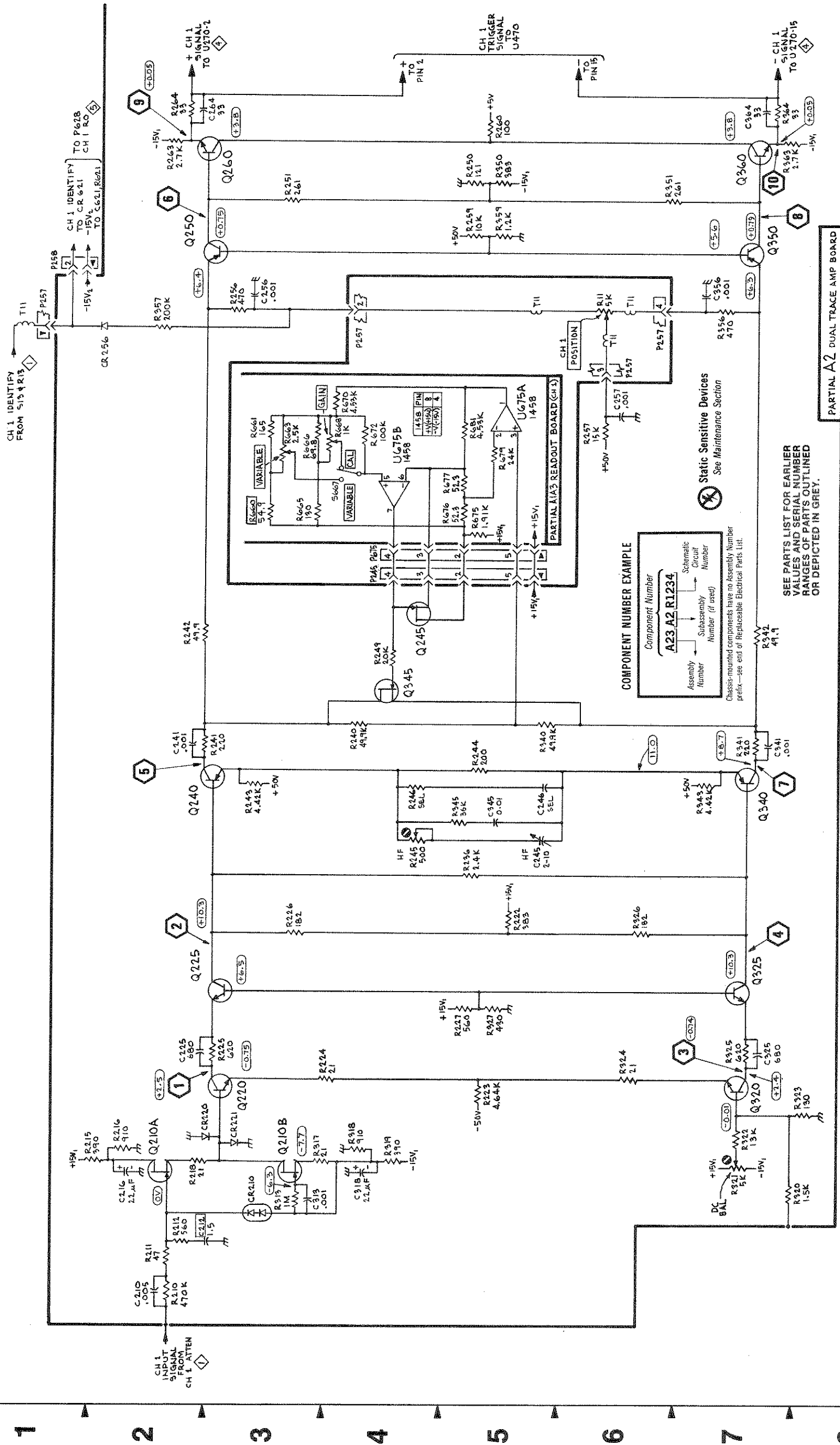

2

CH 1 INPUT AMPLIFIER

4329-10
REV JAN 1965

7A18A

Static Sensitive Devices
See Maintenance Section

COMPONENT NUMBER EXAMPLE

Component Number	A23 A2 R1234
Assembly Number	A23
Subassembly Number (if used)	A2
Schematic Circuit Number	R1234

Chassis-mounted components have no Assembly Number prefix—see end of Replaceable Electrical Parts List.

SEE PARTS LIST FOR EARLIER VALUES AND SERIAL NUMBER RANGES OF PARTS OUTLINED OR DEPICTED IN GREY.

PARTIAL A2 DUAL TRACE AMP BOARD

PARTIAL A2 DUAL TRACE AMP BOARD

CHANNEL 2 INPUT AMPLIFIER 3

P/O A2 ASSY		CH 2 Input Ampl 3			
Circuit Number	Schematic Location	Board Location	Circuit Number	Schematic Location	Board Location
C410	A2	H4	R416	C2	G4
C412	B2	H4	R418	B2	G4
C416	B2	H3	R422	E5	G4
C425	C7	G4	R423	C5	G5
C427	B6	G3	R424	C7	G4
C429	C5	G3	R425	C7	G4
C441	F3	E4	R426	E4	G4
C445	F5	F4	R427	C5	G4
C446	F5	E4	R428	D5	G4
C456	K3	E4	R429	D5	G4
C457	K6	E3	R436	E5	F5
C464	L2	D4	R440	F4	E5
C513	B3	G4	R441	F3	E4
C518	B4	G3	R442	G2	E4
C525	C2	G5	R443	F3	E4
C527	B5	G3	R444	F5	F4
C541	F7	E5	R445	E4	F4
C545	F5	F5	R446	F5	F4
C556	K7	D3	R449	G4	F4
C564	L7	D4	R450	L5	E5
CR410	B3	G3	R451	L3	E4
CR420	C3	G4	R455	K5	D3
CR421	C2	G4	R456	K3	E4
CR456	K2	F3	R459	L5	E4
P429		F4	R460	L2	D4
P445		E4	R463	L2	D4
P455		E3	R464	B3	G3
P457		E3	R513	B3	G3
P458		F4	R518	C4	G3
P549		A2	R519	C4	G3
Q410A	C2	G4	R520	B8	G5
Q410B	C3	G4	R521	B7	F3
Q420	D6	F4	R522	C7	G5
Q425	D7	G4	R523	C8	G5
Q426	F3	F4	R524	C5	G5
Q440	G4	F4	R525	C3	G5
Q445	L2	E4	R526	E6	G5
Q450	L2	D4	R527	C6	F5
Q460	C7	G5	R529	D5	F5
Q520	D3	F5	R540	F5	E5
Q525	D2	G5	R541	F7	E5
Q526	F7	F5	R542	G7	E5
Q540	G4	E4	R543	F7	E5
Q550	K7	D4	R544	G7	E5
Q560	L7	D4	R545	F4	E4
R410	A2	H4	R549	H6	B3
R411	B2	H4	R550	L5	D5
R412	B2	H4	R551	L6	E5
R415	C1	G3	R555	K7	D3
			R556	K7	E5
			R557	K2	F3
			R559	L5	E4
			R563	L7	D5
			R564	L7	D5
P/O A2 ASSY also shown on 2, 4, 6 & 7					
P/O A1A3 ASSY		CH 2 Input Ampl 3			
P675	H3	H1	R675	H5	G1
R660	J3	H1	R676	H4	G1
R663	J3	I1	R677	H4	H1
R665	H3	K1	R679	J5	G1
R666	J3	H1	R681	J4	H1
R668	J4	I1	S667	H4	H1
R670	J4	I1	U675A	J5	G1
R672	J4	H1	U675B	J4	G1
P/O A1A3 ASSY also shown on 2 & 6					

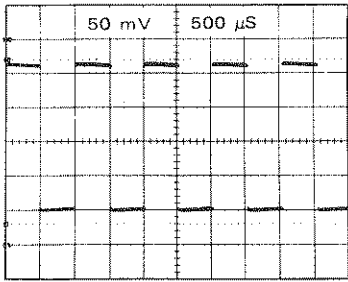

11

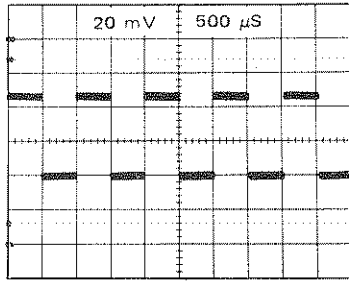

12

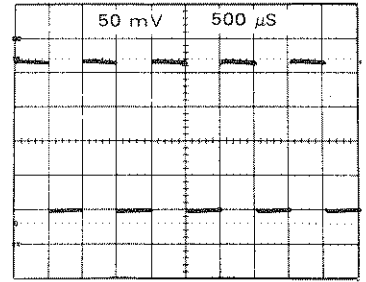

13

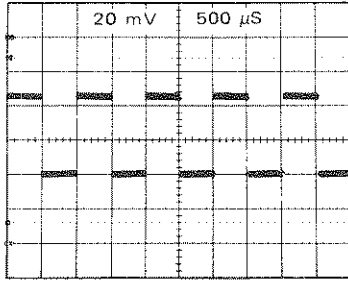

14

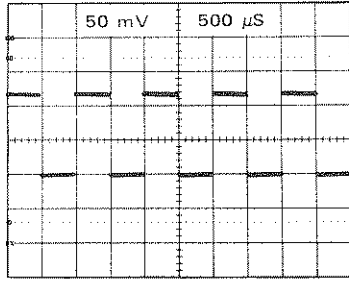

15

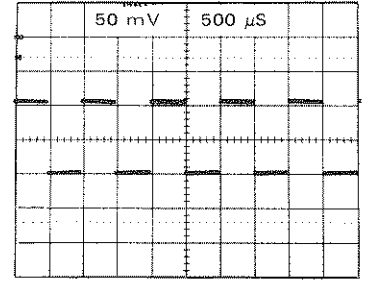

16

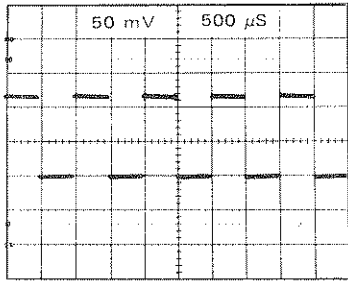

17

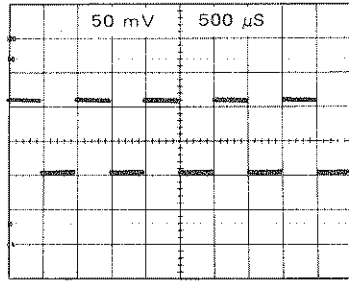

18

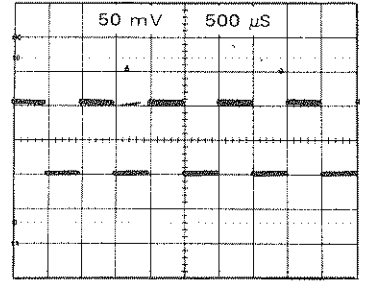

19

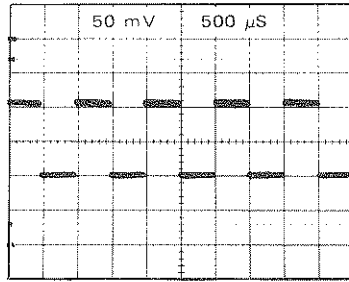

20

3

A B C D E F G H J K L

1 2 3 4 5 6 7 8

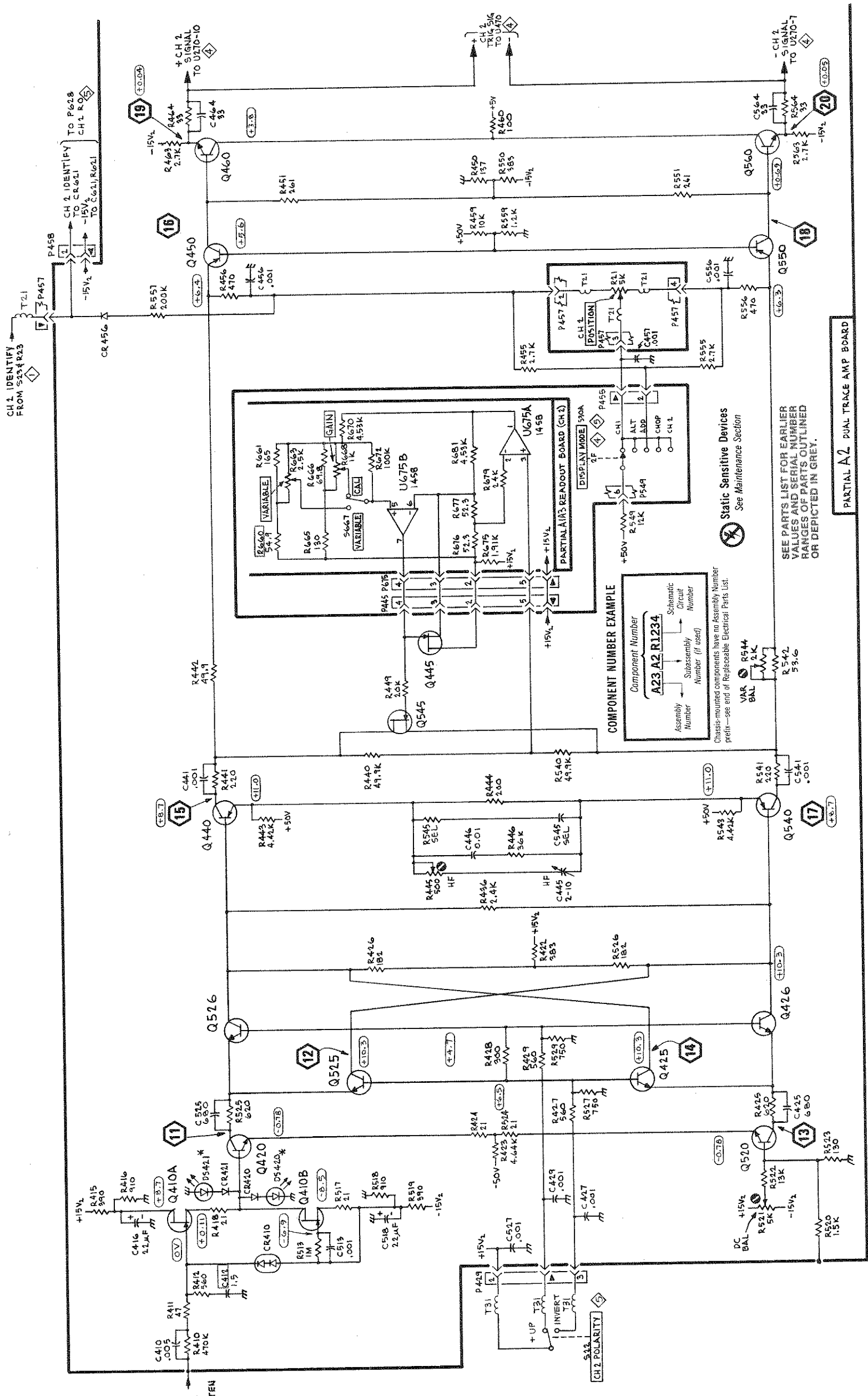

PARTIAL A2 DUAL TRACE AMP BOARD

3

CH2 INPUT AMPLIFIER

4329-11
REV JAN 1985

7A18A

CHANNEL SWITCHING

4

P/O A2 ASSY		Channel Switching 4			
Circuit Number	Schematic Location	Board Location	Circuit Number	Schematic Location	Board Location
C270	J1	D4	R286	L1	B4
C274	G1	D5	R370	G5	C4
C275	G1	D5	R374	C3	C4
C278	G2	C5	R375	G3	C4
C370	G4	D4	R376	G3	C4
C374	G3	D4	R377	G2	C4
C375	G3	D4	R378	G3	B4
C378	G3	C4	R380	K4	C4
C470	J5	D2	R382	K4	C4
C474	G5	D2	R384	L3	B4
C478	G6	C2	R386	L4	B4
C570	G8	D2	R400	B7	B5
C574	G7	D1	R401	B8	B2
C578	H7	B1	R474	G6	B2
C584	K6	B1	R476	G6	C2
P270			R477	G6	C2
P390		C5	R478	G5	C2
P470		A5	R480	K5	C2
P549		C2	R482	K5	C2
		A2	R484	K5	B2
Q280	K1	B4	R486	L5	C1
Q380	L4	B4	R570	G8	C2
Q480	K5	B4	R574	G7	C1
Q580	K8	B2	R576	G7	C1
			R577	G6	C1
R274	G2	C5	R578	G6	C1
R275	G2	C5	R580	K8	C2
R276	G1	C5	R582	K8	B2
R277	G2	C5	R584	K7	B2
R278	G1	C5	R586	L7	B2
R280	K1	B5	U270	J4	C4
R282	K1	C4	U470	J8	C2

P/O A2 ASSY also shown on

2

3

6

&

7

TEST WAVEFORMS FOR DIAGRAM

4

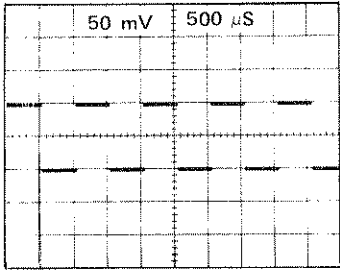

21

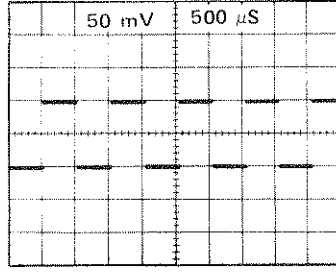

22

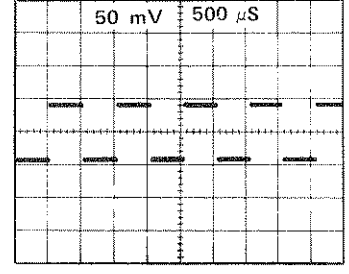

23

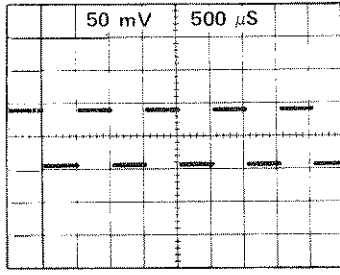

24

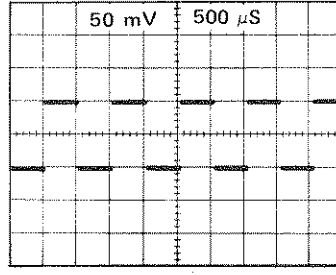

25

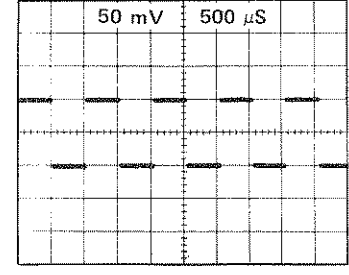

26

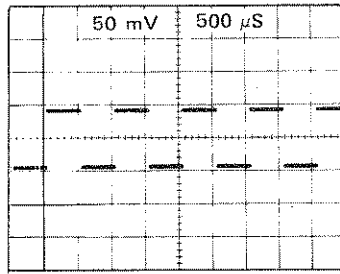

27

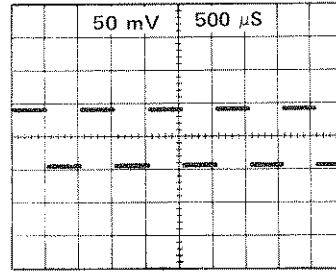

28

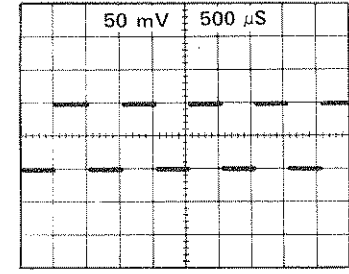

29

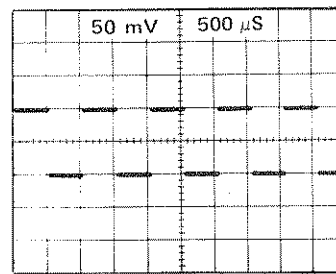

30



A B C D E F G H J K L

1 2 3 4 5 6 7 8

CHANNEL SWITCHING

4

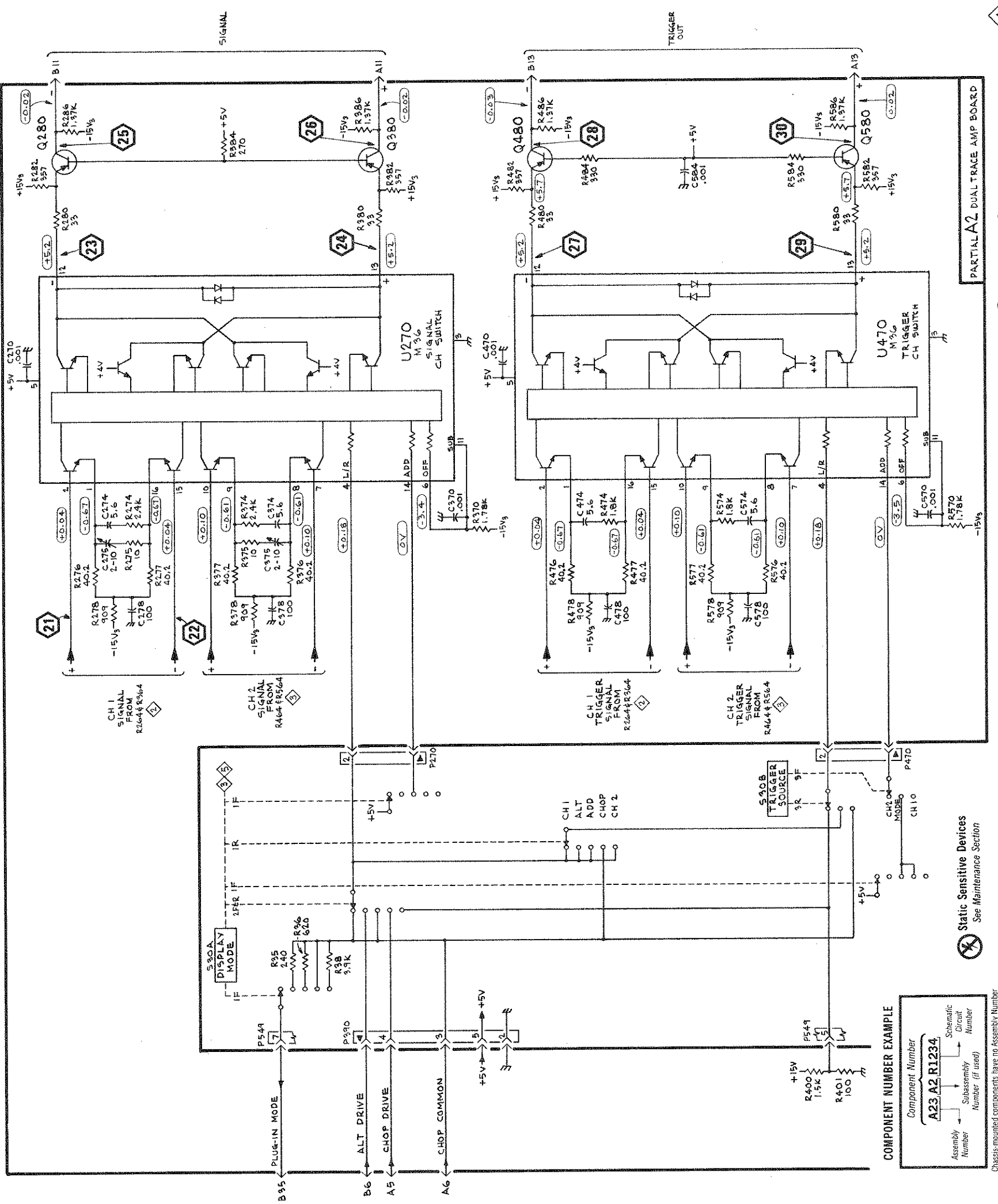

4

CHANNEL SWITCHING

Static Sensitive Devices
See Maintenance Section

COMPONENT NUMBER EXAMPLE
Component Number
A23 A2 R1234
Assembly Number Subassembly Number Schematic Circuit Number
Number (if used)

Chassis-mounted components have no Assembly Number prefix—see end of Replaceable Electrical Parts list.

4329-12
REV MAY 1983

7A18A

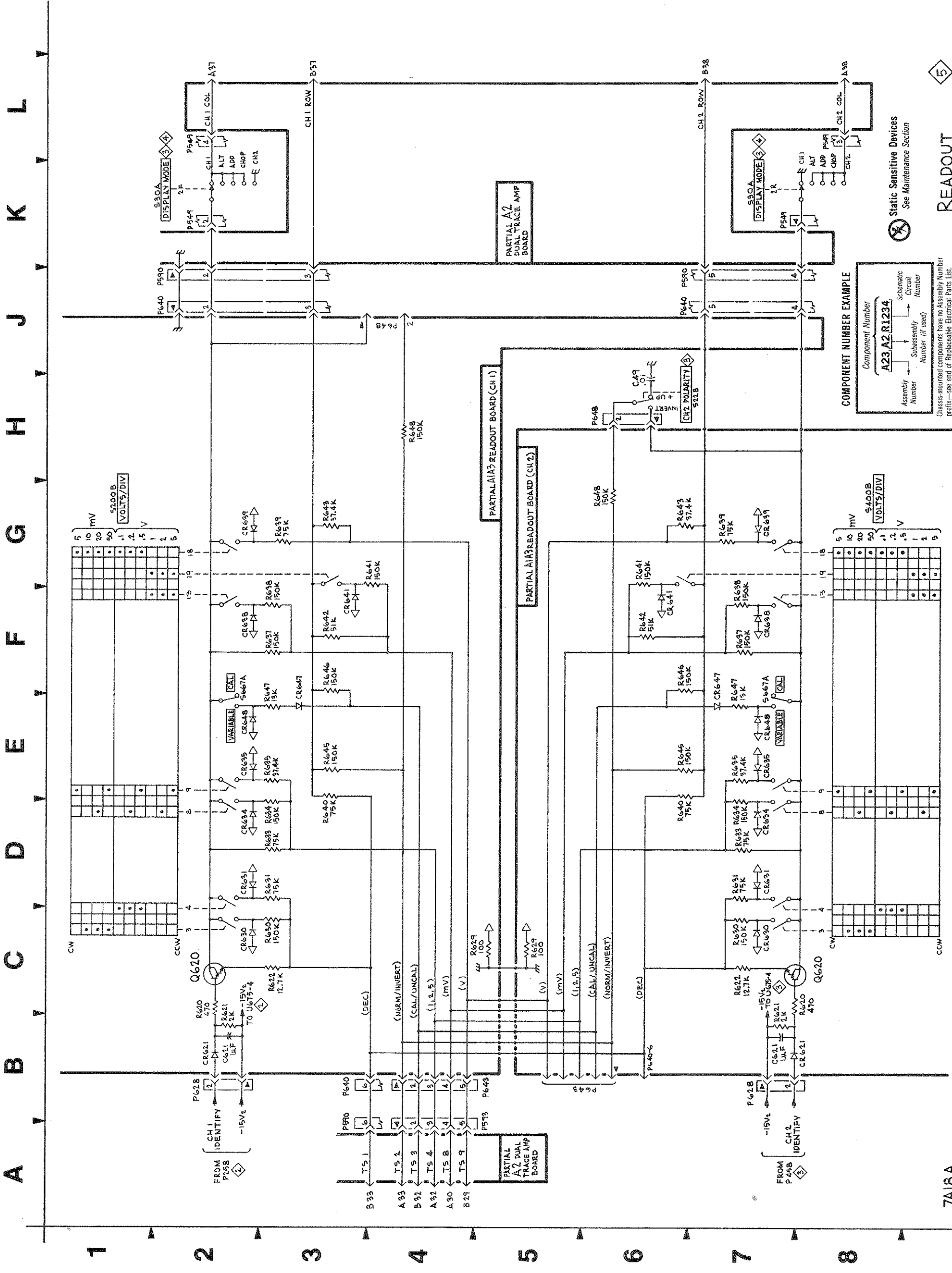

Static Sensitive Devices
See Maintenance Section

READOUT

COMPONENT NUMBER EXAMPLE

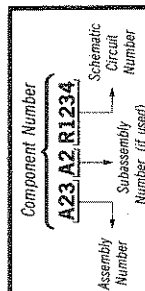

Chassis mounted components have no Assembly Number prefix—see end of Replicable Electrical Parts List.

INTERFACE CONNECTIONS 6

P/O A2 ASSY			Interface Connections 6		
Circuit Number	Schematic Location	Board Location	Circuit Number	Schematic Location	Board Location
C391	D5	B3	LR393	E6	B3
C392	E5	D3	LR395	E5	C3
C393	D5	B3	LR396	E6	C3
C394	E5	C3	LR397	D7	B4
C395	E5	C3	LR591	H5	C3
C396	E6	E3	LR592	G6	B3
C397	D7	B4	LR595	G5	C3
C398	E7	C5	LR596	G6	C3
C591	H5	B3			
C592	G5	F3	R390	C4	B3
C593	H5	B3	R590	J4	B3
C594	G6	C3			
C595	G5	D3	W391	D5	B3
C596	G6	F3	W393	D5	B3
			W591	H5	B3
LR391	D5	C3	W593	H5	B3

P/O A2 ASSY also shown on 2 , 3 , 4 & 6



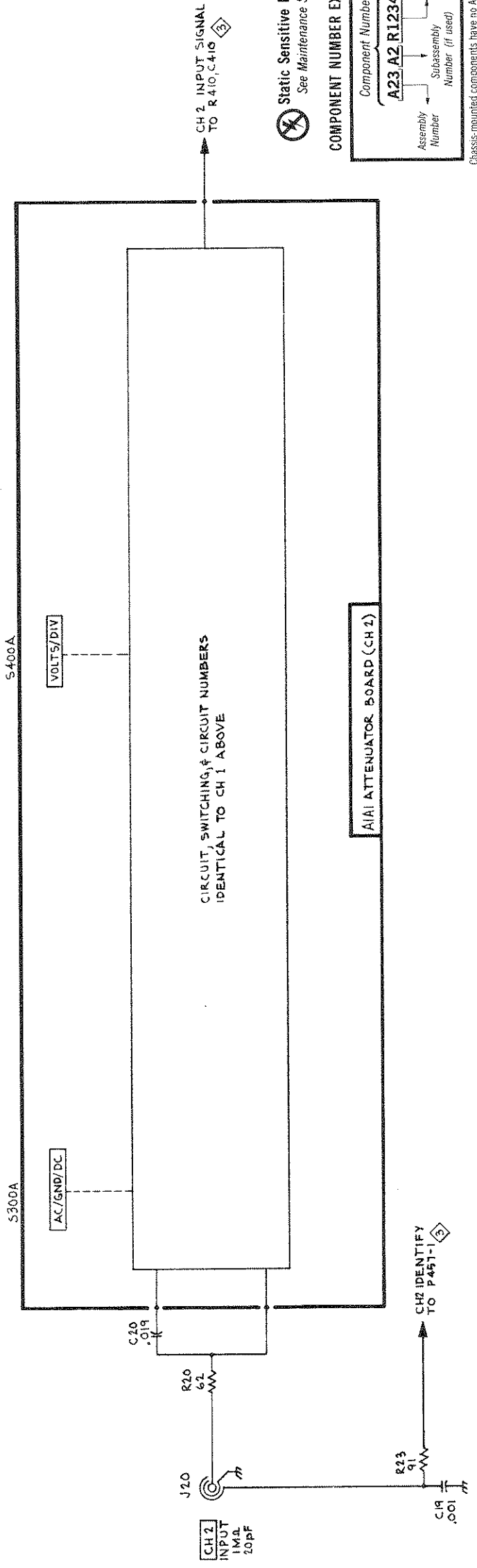
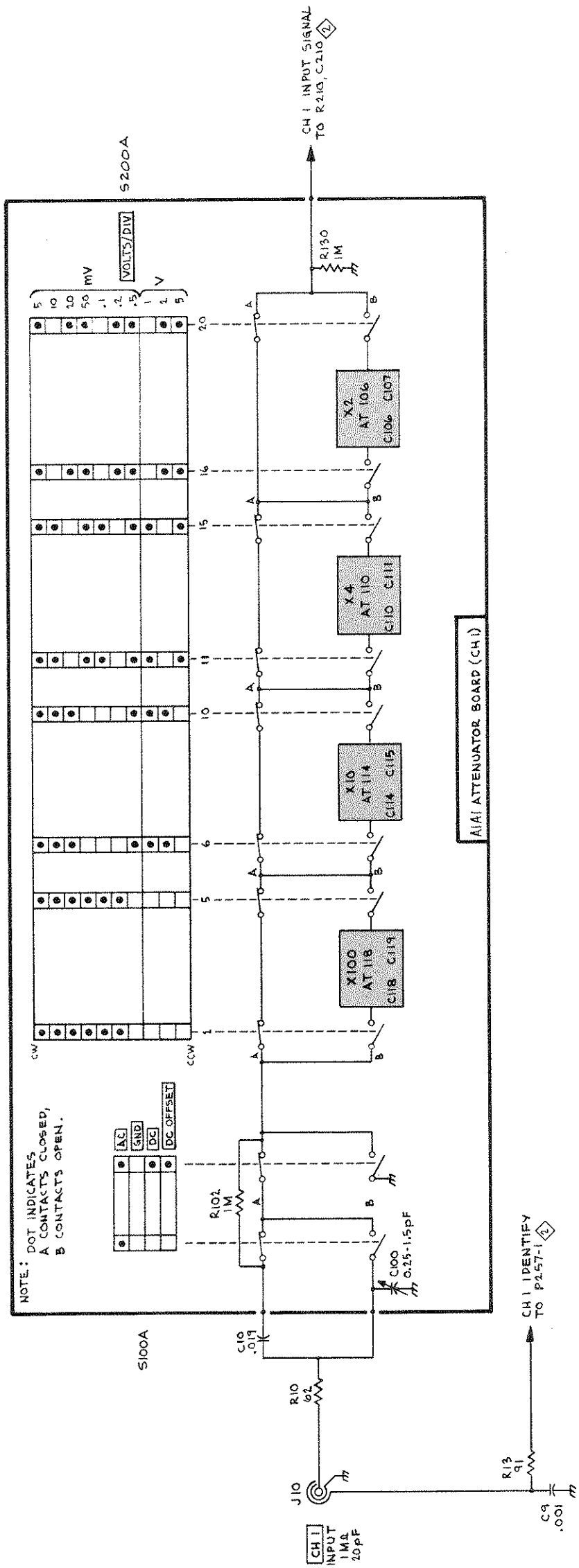

Static Sensitive Devices
See Maintenance Section

COMPONENT NUMBER EXAMPLE

Component Number	A23 A2 R1234
Assembly Number	A23
Subassembly Number (if used)	A2
Schematic Circuit Number	R1234

Chassis-mounted components have no Assembly Number prefix—see end of Replaceable Electrical Parts List.

OPTION 6-CHANNEL 1 INPUT AMPLIFIER

8

P/O A2 ASSY		Option 6-CH 1 Input Ampl	
Circuit Number	Schematic Location	Circuit Number	Schematic Location
C210	A2	R223	C5
C212	B3	R224	C4
C216	B2	R226	E3
C225	C2	R227	D5
C241	F2	R236	E5
C245	E5	R240	F4
C246	F5	R241	F3
C256	K3	R242	G2
C257	J6	R243	F3
C264	L3	R244	F5
C313	B3	R245	E4
C318	B4	R246	F4
C325	D7	R249	G4
C345	F5	R250	L5
C356	K7	R251	L3
C364	L7	R256	K3
		R257	J6
CR210	B3	R259	L5
CR220	C3	R260	L5
CR221	C3	R263	L2
CR256	K2	R264	L2
		R313	B3
DS220	C2	R317	C3
DS221	C3	R318	C4
		R319	C4
Q210A	C2	R320	B8
Q210B	C3	R321	B7
Q225	D2	R322	C7
Q240	F2	R323	C8
Q245	G4	R324	C6
Q250	L2	R325	D7
Q260	L3	R326	E6
Q320	C7	R327	D5
Q325	D7	R340	F5
Q340	F7	R341	F7
Q345	G4	R342	G7
Q350	K7	R343	F7
Q360	L7	R345	F5
		R350	L5
R210	A2	R351	L6
R211	B2	R356	K7
R212	B2	R357	K2
R215	C2	R359	L5
R216	C2	R363	L7
R218	B2	R364	L7
R222	E5		
P/O A2 ASSY also shown on 9			
P/O A1A3 ASSY		Option 6-CH 1 Input Ampl	
Circuit Number	Schematic Location	Circuit Number	Schematic Location
R660	H3	R675	H5
R661	J3	R676	H5
R663	J3	R677	H5
R665	H3	R679	J5
R666	J3	R681	J5
R668	J4	S667	H4
R670	J4	U675A	J4
R672	J4	U675B	J5
P/O A1A3 ASSY also shown on 9			



A B C D E F G H J K L Y

OPTION 06-CHANNEL 1 INPUT AMPLIFIER

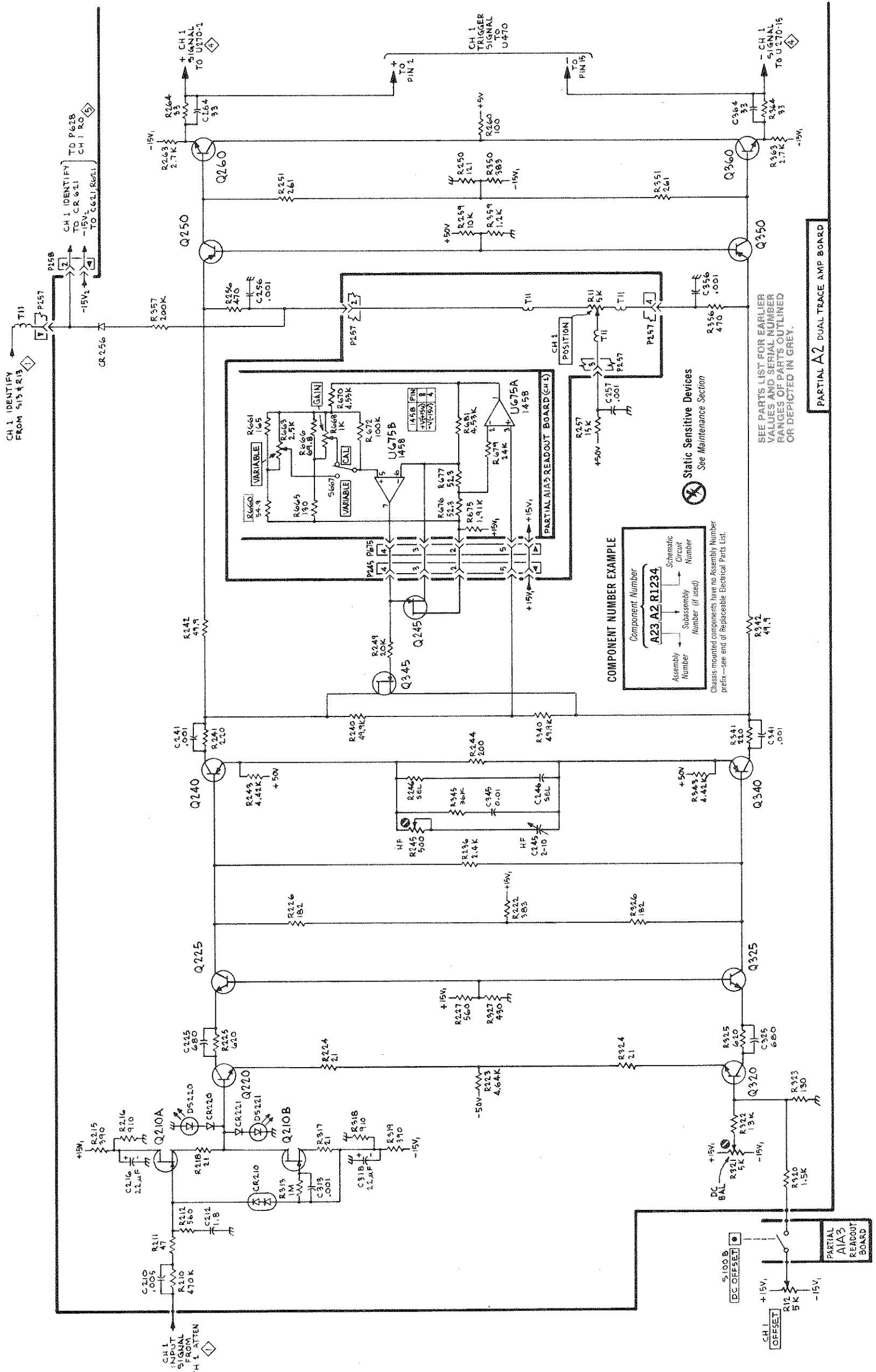

SEE PARTS LIST FOR EARLIER VALUES AND SERIAL NUMBER RANGES OF PARTS OUTLINED OR DEPICTED IN GREY.

COMPONENT NUMBER EXAMPLE
 Component Number
 Assembly Number
 Subassembly Number (if used)
 Schematic Number
 Circuit Number

Chassis-mounted components have no Assembly Number prefix—see end of Replaceable Electrical Parts List.

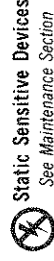

Static Sensitive Devices
 See Maintenance Section

PARTIAL A2 DUAL TRACE AMP BOARD



OPTION 06-CH 1 INPUT AMPLIFIER

4529-16
 REV SEP 1984

7A18A

OPTION 6-CHANNEL 2 INPUT AMPLIFIER

9

P/O A2 ASSY		Option 6-CH 2 Input Ampli	
Circuit Number	Schematic Location	Circuit Number	Schematic Location
C410	A2	R422	E5
C412	B2	R423	C5
C416	B2	R424	C5
C425	C7	R425	C7
C427	B6	R426	E4
C429	C5	R427	C5
C441	F3	R428	D5
C445	E5	R429	D5
C446	F5	R436	E5
C456	K3	R440	F4
C457	K6	R441	F3
C464	L2	R442	G2
C513	B3	R443	F3
C518	B4	R444	F5
C525	C2	R445	E4
C527	B5	R446	F5
C541	F7	R449	G4
C545	F5	R450	L5
C556	K7	R451	L3
C564	L7	R455	K5
		R456	K3
CR410	B3	R459	L5
CR420	C3	R460	L5
CR421	C2	R463	L2
CR456	K2	R464	L2
		R513	B3
DS420	C3	R518	C4
DS421	C2	R519	C4
		R520	B8
Q410A	C2	R521	B7
Q410B	C3	R522	C7
Q420	C3	R523	C8
Q425	D6	R524	C5
Q426	D7	R525	C3
Q440	F3	R526	E6
Q445	G4	R527	C6
Q450	L2	R529	D5
Q460	L2	R540	F5
Q520	C7	R541	F7
Q525	D3	R542	G7
Q526	D2	R543	F7
Q540	F7	R544	G7
Q545	G4	R545	F4
Q550	K7	R549	H6
Q560	L7	R550	L5
		R551	L6
R410	A2	R555	K7
R411	B2	R556	K7
R412	B2	R557	K2
R415	C1	R559	L5
R416	C2	R563	L7
R418	B2	R564	L7
P/O A2 ASSY also shown on 8			
P/O A1A3 ASSY		Option 6-CH 2 Input Ampli	
Circuit Number	Schematic Location	Circuit Number	Schematic Location
R660	H3	R675	H5
R661	J3	R676	H4
R663	J3	R677	H4
R665	H3	R679	J5
R666	J3	R681	J4
R668	J4	S667	H4
R670	J4	U675A	J5
R672	J4	U675B	J4
P/O A1A3 ASSY also shown on 8			



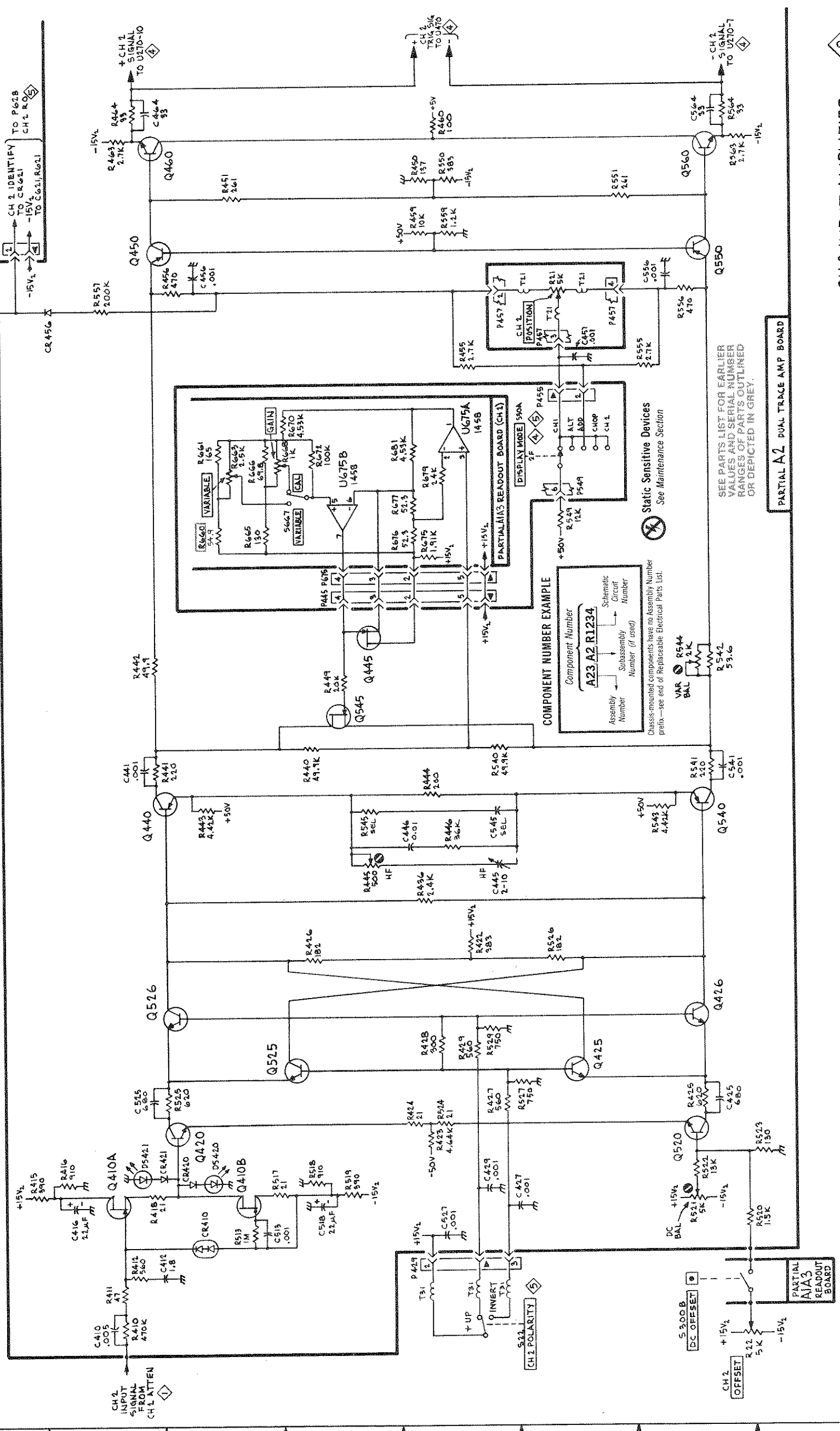

SEE PARTS LIST FOR EARLIER VALUES AND SERIAL NUMBER RANGES OF PARTS OUTLINED OR DEPICTED IN GREY.

COMPONENT NUMBER EXAMPLE

Assembly Number	Subassembly Number (if used)	Schematic Circuit Number
A23 A2	R1234	

Chassis-mounted components have no Assembly Number prefix—see end of Replaceable Electrical Parts List.

Static Sensitive Devices
See Maintenance Section

PARTIAL A2 DUAL TRACE AMP BOARD

A B C D E F G H I J K L

REPLACEABLE MECHANICAL PARTS

PARTS ORDERING INFORMATION

Replacement parts are available from or through your local Tektronix, Inc. Field Office or representative.

Changes to Tektronix instruments are sometimes made to accommodate improved components as they become available, and to give you the benefit of the latest circuit improvements developed in our engineering department. It is therefore important, when ordering parts, to include the following information in your order: Part number, instrument type or number, serial number, and modification number if applicable.

If a part you have ordered has been replaced with a new or improved part, your local Tektronix, Inc. Field Office or representative will contact you concerning any change in part number.

Change information, if any, is located at the rear of this manual.

ITEM NAME

In the Parts List, an Item Name is separated from the description by a colon (:). Because of space limitations, an Item Name may sometimes appear as incomplete. For further Item Name identification, the U.S. Federal Cataloging Handbook H6-1 can be utilized where possible.

FIGURE AND INDEX NUMBERS

Items in this section are referenced by figure and index numbers to the illustrations.

INDENTATION SYSTEM

This mechanical parts list is indented to indicate item relationships. Following is an example of the indentation system used in the description column.

```

1 2 3 4 5           Name & Description
Assembly and/or Component
Attaching parts for Assembly and/or Component
-----
Detail Part of Assembly and/or Component
Attaching parts for Detail Part
-----
Parts of Detail Part
Attaching parts for Parts of Detail Part
-----

```

Attaching Parts always appear in the same indentation as the item it mounts, while the detail parts are indented to the right. Indented items are part of, and included with, the next higher indentation. The separation symbol - - - - - indicates the end of attaching parts.

Attaching parts must be purchased separately, unless otherwise specified.

ABBREVIATIONS

INCH	ELECTRN	ELECTRON	IN	INCH	SE	SINGLE END
# NUMBER SIZE	ELEC	ELECTRICAL	INCAND	INCANDESCENT	SECT	SECTION
ACTR ACTUATOR	ELECTLT	ELECTROLYTIC	INSUL	INSULATOR	SEMICON	SEMICONDUCTOR
ADPTR ADAPTER	ELEM	ELEMENT	INTL	INTERNAL	SHLD	SHIELD
ALIGN ALIGNMENT	EPL	ELECTRICAL PARTS LIST	LPHLDR	LAMPHOLDER	SHLDR	SHOULDERED
AL ALUMINUM	EQPT	EQUIPMENT	MACH	MACHINE	SKT	SOCKET
ASSEM ASSEMBLED	EXT	EXTERNAL	MECH	MECHANICAL	SL	SLIDE
ASSY ASSEMBLY	FIL	FILLISTER HEAD	MTG	MOUNTING	SLFLKG	SELF-LOCKING
ATTEN ATTENUATOR	FLEX	FLEXIBLE	NIP	NIPPLE	SLVG	SLEEVEING
AWG AMERICAN WIRE GAGE	FLH	FLAT HEAD	NON WIRE	NOT WIRE WOUND	SPR	SPRING
BD BOARD	FLTR	FILTER	OBD	ORDER BY DESCRIPTION	SQ	SQUARE
BRKT BRACKET	FR	FRAME or FRONT	OD	OUTSIDE DIAMETER	SST	STAINLESS STEEL
BRS BRASS	FSTNR	FASTENER	OVH	OVAL HEAD	STL	STEEL
BRZ BRONZE	FT	FOOT	PH BRZ	PHOSPHOR BRONZE	SW	SWITCH
BSHG BUSHING	FXD	FIXED	PL	PLAIN or PLATE	T	TUBE
CAB CABINET	GSKT	GASKET	PLSTC	PLASTIC	TERM	TERMINAL
CAP CAPACITOR	HDL	HANDLE	PN	PART NUMBER	THD	THREAD
CER CERAMIC	HEX	HEXAGON	PNH	PAN HEAD	THK	THICK
CHAS CHASSIS	HEX HD	HEXAGONAL HEAD	PWR	POWER	TNSN	TENSION
CKT CIRCUIT	HEX SOC	HEXAGONAL SOCKET	RCPT	RECEPTACLE	TPG	TAPPING
COMP COMPOSITION	HLCP	HELICAL COMPRESSION	RES	RESISTOR	TRH	TRUSS HEAD
CONN CONNECTOR	HLEXT	HELICAL EXTENSION	RGD	RIGID	V	VOLTAGE
COV COVER	HV	HIGH VOLTAGE	RLF	RELIEF	VAR	VARIABLE
CPLG COUPLING	IC	INTEGRATED CIRCUIT	RTNR	RETAINER	W/	WITH
CRT CATHODE RAY TUBE	ID	INSIDE DIAMETER	SCH	SOCKET HEAD	WSHR	WASHER
DEG DEGREE	IDEN	IDENTIFICATION	SCOPE	OSCILLOSCOPE	XFMR	TRANSFORMER
DWR DRAWER	IMPLR	IMPELLER	SCR	SCREW	XSTR	TRANSISTOR

CROSS INDEX—MFR. CODE NUMBER TO MANUFACTURER

Mfr. Code	Manufacturer	Address	City, State, Zip
000BK	STAUFFER SUPPLY	105 SE TAYLOR	PORTLAND, OR 97214
000CY	NORTHWEST FASTENER SALES, INC.	7923 SW CIRRUS DRIVE	BEAVERTON, OR 97005
000FW	WESTERN SINTERING CO INC.	2620 STEVENS DRIVE	RICHLAND, WA 99352
00779	AMP, INC.	P.O. BOX 3608	HARRISBURG, PA 17105
01121	ALLEN-BRADLEY COMPANY	1201 2ND STREET SOUTH	MILWAUKEE, WI 53204
09922	BURNDY CORPORATION	RICHARDS AVENUE	NORWALK, CT 06852
12327	FREEWAY CORPORATION	9301 ALLEN DRIVE	CLEVELAND, OH 44125
22526	BERG ELECTRONICS, INC.	YOKU EXPRESSWAY	NEW CUMBERLAND, PA 17070
22599	ESNA, DIV. OF AMERACE CORPORATION	16150 STAGG STREET	VAN NUYS, CA 91409
24931	SPECIALITY CONNECTOR CO., INC.	2620 ENDRESS PLACE	GREENWOOD, IN 46142
70278	ALLIED STEEL AND CONVEYORS, DIV. OF SPARTON CORP.	17333 HEALY	DETROIT, MI 48212
71590	CENTRALAB ELECTRONICS, DIV. OF GLOBE-UNION, INC.	P O BOX 858	FORT DODGE, IA 50501
72228	CONTINENTAL SCREW CO., DIV. OF AMTEL, INC.	459 MT. PLEASANT	NEW BEDFORD, MA 02742
73743	FISCHER SPECIAL MFG. CO.	446 MORGAN ST.	CINCINNATI, OH 45206
77900	SHAKEPROOF		
78189	DIV OF ILLINOIS TOOL WORKS	SAINT CHARLES RD	ELGIN, IL 60120
79136	ILLINOIS TOOL WORKS, INC.	ST. CHARLES ROAD	ELGIN, IL 60120
80009	SHAKEPROOF DIVISION	47-16 AUSTEL PLACE	LONG ISLAND CITY, NY 11101
83385	WALDES, KOHINOOR, INC.	P O BOX 500	BEAVERTON, OR 97077
86928	TEKTRONIX, INC.	2530 CRESCENT DR.	BROADVIEW, IL 60153
87308	CENTRAL SCREW CO.	701 SONORA AVENUE	GLENDALE, CA 91201
92101	SEASTROM MFG. COMPANY, INC.		
93907	N. L. INDUSTRIES, INC., SOUTHERN SCREW DIV.	P. O. BOX 1360	STATESVILLE, NC 28677
97464	SCHULZE MFG, 50 INGOLD RD		
T0435	BURLINGAME, CA 94010		
T0588	TEXTRON INC. CAMCAR DIV	600 18TH AVE	ROCKFORD, IL 61101
	INDUSTRIAL RETAINING RING CO.	57 CORDIER ST.	IRVINGTON, NJ 07111
	LEWIS SCREW CO.	4114 SOUTH PERORIA AVE.	CHICAGO, IL 60609
	UNIVERSAL PRECISION PRODUCTS	1775 NW 216TH	HILLSBORO, OR 97123

Fig. & Index No.	Tektronix Part No.	Serial/Model No.		Qty	1	2	3	4	5	Name & Description	Mfr	Mfr Part Number
		Eff	Dscont								Code	
1-1	337-1064-04	B010100	B010450	1						SHIELD,ELEC:SIDE PLUG-IN UNITS	80009	337-1064-00
	337-1064-12	B010451		1						SHIELD,ELEC:SIDE FOR PLUG-IN UNIT	80009	337-1064-12
-2	366-1077-00			2						KNOB:GRAY	80009	366-1077-00
	213-0153-00			2						.SETSCREW:5-40 X 0.125,STL BK OXD,HEX	000CY	ORD BY DESCR
-3	366-1059-00			2						PUSH BUTTON:GRAY	80009	366-1059-00
-4	131-0679-02			2						CONNECTOR,RCPT.:BNC,MALE,3 CONTACT	24931	28JR270-1
										*****ATTACHING PARTS*****		
-5	220-0497-00			2						NUT,PLAIN,HEX.:0.5-28 X 0.562 INCH HEX,BRS	73743	ORD BY DESCR
-6	210-1039-00			2						WASHER,LOCK:INT,0.521 ID X 0.625 INCH O	24931	ORD BY DESCR
										*****END ATTACHING PARTS*****		
-7	366-1308-00			2						KNOB:RED	80009	366-1308-00
	213-0153-00			2						.SETSCREW:5-40 X 0.125,STL BK OXD,HEX	000CY	ORD BY DESCR
-8	366-1058-83			1						KNOB,LATCH:GRAY	80009	366-1058-83
										*****ATTACHING PARTS*****		
-9	214-1095-00			1						PIN,SPG,SPLIT:0.094 OD X 0.187 INCH LONG	22599	52-022-094-0187
										*****END ATTACHING PARTS*****		
-10	105-0076-04			1						RELEASE BAR,LCH:PLUG-IN UNIT	80009	105-0076-04
-11	366-1163-00			1						KNOB:LIGHT GRAY	80009	366-1163-00
	213-0153-00			1						.SETSCREW:5-40 X 0.125,STL BK OXD,HEX	000CY	ORD BY DESCR
-12	214-1280-00			1						SPRING,HLCPS:0.14 OD X 1.126"L,0.16"DIA	80009	214-1280-00
-13	366-1165-00			1						KNOB:GRAY	80009	366-1165-00
	213-0153-00			2						.SETSCREW:5-40 X 0.125,STL BK OXD,HEX	000CY	ORD BY DESCR
-14	366-0215-01	B010100	B012129	2						KNOB:LEVER SWITCH	80009	366-0215-01
	366-0215-02	B012130		2						RES.,FXD,CMPSN:220 OHM,5%,0.25W	01121	CB2215
-15	366-1299-00			2						KNOB:GRAY	80009	366-1299-00
	213-0153-00			4						.SETSCREW:5-40 X 0.125,STL BK OXD,HEX	000CY	ORD BY DESCR
-16	214-3369-00			2						SPRING,GROUND:	80009	214-3369-00
-17	333-1411-01			1						PANEL,FRONT:	80009	333-1411-01
-18	348-0235-00			2						SHLD GSKT,ELEC:4.734 INCH LONG	92101	ORD BY DESCR
-19	358-0216-00			1						BUSHING,PLASTIC:0.257 ID X 0.412 INCH OD	80009	358-0216-00
-20	131-1075-00			1						CONTACT,ELEC:GROUNDING,CU BE HEAT TRTD	80009	131-1075-00
-21	-----			1						SWITCH,SLIDE:(SEE S22 REPL)		
										*****ATTACHING PARTS*****		
-22	210-0405-00			2						NUT,PLAIN,HEX:2-56 X 0.188,BRS,CD PL	73743	12157-50
-23	210-0259-00			2						TERMINAL,LUG:0.099 ID,LOCKING,BRS,CD PL	80009	210-0259-00
-24	211-0030-00			2						SCREW,MACHINE:2-56 X 0.25,FLH,82DEG,STL	83385	ORD BY DESCR
										*****END ATTACHING PARTS*****		
-25	-----			2						RESISTOR,VAR:(SEE R11, R21 REPL)		
										*****ATTACHING PARTS*****		
-26	210-0583-00			2						NUT,PLAIN,HEX:0.25-32 X 0.312 INCH,BRS	73743	2X20317-402
										*****END ATTACHING PARTS*****		
-27	210-0223-01			2						TERMINAL,LUG:0.25 INCH DIA,SE,60 DEG BEN	86928	ORD BY DESCR
-28	386-1447-54			1						SUBPANEL,FRONT:	80009	386-1447-54
										*****ATTACHING PARTS*****		
-29	213-0793-00			4						SCREW,TPG,TF:6-32 X 0.4375,TAPTITE,FIL	93907	ORD BY DESCR
										*****END ATTACHING PARTS*****		
-30	214-1054-00			1						SPRING,FLAT:0.825 X 0.322,SST	80009	214-1054-00
-31	105-0075-00			1						BOLT,LATCH:7A & 7B SER PL-IN	80009	105-0075-00
-32	210-0288-00			2						TERMINAL,LUG:0.125 ID X 1.125 INCH LONG	80009	210-0288-00
										*****ATTACHING PARTS*****		
-33	210-0586-00			2						NUT,PL,ASSEM WA:4-40 X 0.25,STL CD PL	T0435	ORD BY DESCR
-34	211-0105-00			2						SCREW,MACHINE:4-40 X 0.188,100 DEG,FLH ST	83385	ORD BY DESCR
										*****END ATTACHING PARTS*****		
-35	200-1199-04			2						COV,ATTEN CHAS:	80009	200-1199-04
										*****ATTACHING PARTS*****		
-36	211-0007-00			8						SCREW,MACHINE:4-40 X 0.188,PNH STL,CD PL	83385	ORD BY DESCR
-37	210-0004-00			8						WASHER,LOCK:#4 INTL,0.015 THK,STL CD PL	77900	1204-00-000541C
										*****END ATTACHING PARTS*****		
-38	337-1423-05			2						SHIELD,ELEC:ATTENUATOR	80009	337-1423-05
										*****ATTACHING PARTS*****		
-39	213-0055-00			2						SCR,TPG,THD FOR:2-32 X 0.188 INCH,PNH STL	93907	ORD BY DESCR
										*****END ATTACHING PARTS*****		
-40	407-0906-00			1						BRKT,CKT BD:BRASS CU-SN-ZN	80009	407-0906-00
										*****ATTACHING PARTS*****		
-41	210-0586-00			2						NUT,PL,ASSEM WA:4-40 X 0.25,STL CD PL	T0435	ORD BY DESCR
-42	211-0008-00			4						SCREW,MACHINE:4-40 X 0.250,PNH,STL,POZ	83385	ORD BY DESCR
										*****END ATTACHING PARTS*****		

Replaceable Mechanical Parts—7A18A

Fig. & Index No.	Tektronix Part No.	Serial/Model No.		Qty	1	2	3	4	5	Name & Description	Mfr Code	Mfr Part Number
		Eff	Dscont									
1-43	-----			1						CKT BOARD ASSY:AMPLIFIER(SEE A2 REPL) ***** (ATTACHING PARTS)*****		
-44	211-0008-00			4						SCREW,MACHINE:4-40 X 0.250,PNH,STL,POZ ***** (END ATTACHING PARTS)*****	83385	ORD BY DESCR
	-----			-						CKT BOARD ASSY INCLUDES:		
-45	214-0579-00			1						.TERM,TEST POINT:BRS CD PL	80009	214-0579-00
-46	124-0162-00			2						.TERMINAL BOARD:4 NOTCH,CERAMIC,STUD MTD	80009	124-0162-00
-47	355-0046-00			2						.MOUNT,TERM. BD:0.577 INCH H	80009	355-0046-00
-48	136-0729-00			2						.SKT,PL-IN ELEK:MICROCKT,16 CONTACT	09922	DILB16P-108T
-49	200-0945-01			4						.COVER,HALF XSTR:DUAL TO-18,W/2-56 THD ***** (ATTACHING PARTS)*****	80009	200-0945-01
-50	211-0001-00			4						.SCREW,MACHINE:2-56 X 0.25 INCH,PNH STL ***** (END ATTACHING PARTS)*****	87308	ORD BY DESCR
-51	200-0945-00			4						.COVER,HALF XSTR:DUAL TO-18,ALUMINUM	80009	200-0945-00
-52	136-0252-07			76						.SOCKET,PIN CONN:W/O DIMPLE	22526	75060-012
-53	131-0608-00			48						.TERMINAL,PIN:0.365 L X 0.025 PH BRZ GOLD	22526	48283-036
-54	407-0912-00			1						.BRACKET,CKT BD:BRASS CU-SN-ZN PL	80009	407-0912-00
-55	214-1061-00			1						.SPRING,GROUND:FLAT	80009	214-1061-00
-56	129-0554-01			2						.SPACER,POST:0.975L W/0.094 ID ***** (ATTACHING PARTS)*****	80009	129-0554-01
-57	211-0008-00	B010100	B011599	4						SCREW,MACHINE:4-40 X 0.250,PNH,STL,POZ	83385	ORD BY DESCR
	213-0912-00	B011600		4						SCREW,TPG,TF:4-20 X 0.25,PNH,STL,CD,PL ***** (END ATTACHING PARTS)*****	72228	ORD BY DESCR
-58	-----			1						SWITCH ASSY:(SEE S30 REPL) ***** (ATTACHING PARTS)*****		
-59	210-0590-00			1						NUT,PLAIN,HEX:0.375-32 X 0.438" BRS	73743	2X28269-402
-60	210-0012-00			1						WASHER,LOCK:INTL,0.384 ID,INTL,0.022 TH ***** (END ATTACHING PARTS)*****	77900	1220-02-00-0541C
	-----			-						SWITCH ASSY INCLUDES:		
-61	175-3093-00			2						.LEAD ASSY,ELEC:2.26 AWG,3.0 L,RIBBON	80009	175-3093-00
-62	352-0169-00			2						.HLDR,TERM CONN:2 WIRE,BLACK	80009	352-0169-00
-63	175-6178-00			1						.CA ASSY,SP,ELEC:2.26 AWG,4.0 L,RIBBON	80009	175-6178-00
-64	352-0169-05			1						.HLDR,TERM CONN:2 WIRE,GREEN	80009	352-0169-05
-65	175-6998-00			1						.CA ASSY,SP,ELEC:2.26 AWG,4.0 L,RIBBON	80009	175-6998-00
-66	352-0163-00			1						.HLDR,TERM CONN:5 WIRE,BLACK	80009	352-0163-00
-67	175-5414-00			1						.CA ASSY,SP,ELEC:7.26 AWG,3.5 L,RIBBON	80009	175-5414-00
-68	352-0165-09			1						.HLDR,TERM CONN:7 WIRE,WHITE	80009	352-0165-09
	-----			2						CKT BD ASSY:CAM SW & READOUT(SEE A1 REPL)		
-69	441-0992-04			2						.CHAS,PL-IN UNIT:ATTENUATOR ***** (ATTACHING PARTS)*****	80009	441-0992-04
-70	211-0097-00			4						.SCREW,MACHINE:4-40 X 0.312 INCH,PNH STL	83385	ORD BY DESCR
-71	210-0004-00			4						.WASHER,LOCK:#4 INTL,0.015 THK,STL CD PL	77900	1204-00-000541C
-72	129-0299-00			8						.POST,ELEC-MECH:HEX,0.333 INCH LONG	80009	129-0299-00
-73	210-0004-00			8						.WASHER,LOCK:#4 INTL,0.015 THK,STL CD PL	77900	1204-00-000541C
-74	210-0405-00			6						NUT,PLAIN,HEX:2-56 X 0.188,BRS,CD PL	73743	12157-50
-75	211-0001-00			6						.SCREW,MACHINE:2-56 X 0.25 INCH,PNH STL	87308	ORD BY DESCR
-76	210-0053-00			6						.WASHER,LOCK:#2 SPLIT,0.02THK STL CAD PL		ORD BY DESCR
-77	210-1134-00			6						.WASHER,FLAT:0.09 ID X 0.25 INCH OD,BRS ***** (END ATTACHING PARTS)*****	12327	ORD BY DESCR
-78	-----			2						.CKT BOARD ASSY:ATTENUATOR(SEE A1A1 REPL)		
-79	131-1031-00			20						.CONTACT ASSY,EL:CAM SWITCH,TOP	80009	131-1031-00
-80	131-1030-00			20						.CONT ASSY,ELEC:CAM SWITCH,BOTTOM	80009	131-1030-00
-81	136-0252-01			16						.CONTACT,ELEC:0.178 INCH LONG	00779	1-332095-2
-82	136-0333-00			4						.SOCKET,PIN TERM:U/W 0.03 DIA PINS	00779	1-331677-4
-83	210-3082-00			20						.EYELET,METALLIC:0.047 OD X 0.133 L,BRASS	80009	210-3082-00
-84	337-1406-00			2						.SHLD,ELECTRICAL:CAM CONTACTS	80009	337-1406-00
-85	-----			2						.SW,CAM ACTR,ASSY:VOLTS/DIV(SEE A1A2 REPL) ***** (ATTACHING PARTS)*****		
-86	211-0292-00			12						.SCR,ASSEM WSHR:4-40 X 0.29,BRS NI PL	78189	51-040445-01
-87	131-0907-00			4						.CONTACT,ELEC:GROUNDING,CU BE ALBALOY PL ***** (END ATTACHING PARTS)*****	80009	131-0907-00
	-----			-						.CAM SWITCH ASSY INCLUDES:		
-88	105-0243-00			2						.ACTUATOR,SWITCH:AC,DC ***** (ATTACHING PARTS)*****	80009	105-0243-00
-89	213-0214-00			2						.SCREW,CAP SCH:2-56 X 0.375"HEX HD STL ***** (END ATTACHING PARTS)*****	70278	ORD BY DESCR

Fig. & Index No.	Tektronix Part No.	Serial/Model No.		Qty	Name & Description	Mfr Code	Mfr Part Number
		Eff	Dscont				
1-90	401-0180-00			2	..BEARING,CAM SW:FRONT & REAR(ATTACHING PARTS).....	80009	401-0180-00
-91	354-0390-00			2	..RING,RETAINING:0.338 ID X 0.025" THK,STL(END ATTACHING PARTS).....	79136	5100-37MD
-92	210-0406-00			24	..NUT,PLAIN,HEX:4-40 X 0.188,BRS,CD PL	73743	12161-50
-93	214-1752-00			8	..ROLLER,DETENT:	80009	214-1752-00
-94	214-1139-00			2	..SPRING,FLAT:0.885 X 0.156 CU BE GLD CLR	80009	214-1139-00
	214-1139-02			4	..SPRING,FLAT:GREEN COLORED	80009	214-1139-02
	214-1139-03			4	..SPRING,FLAT:RED COLORED	80009	214-1139-03
-95	-----			2	..ACTUATOR,CAM SW:(SEE A1A2S100,S300 REPL)		
-96	384-0878-01			2	..SHAFT,CAM SW:FRONT	80009	384-0878-01
-97	401-0178-00			2	..BEARING,CAM SW:CENTER(ATTACHING PARTS).....	80009	401-0178-00
-98	354-0443-00			2	..RING,RETAINING:0.328 FREE ID X 0.448 OD(END ATTACHING PARTS).....	97464	200-37
-99	-----			2	..ACTUATOR,CAM SW:(SEE A1A2S200,S400 REPL)		
-100	384-0880-01			2	..SHAFT,CAM SW:2.927 L X 0.188 OD,INTMD	80009	384-0880-01
-101	401-0180-00			2	..BEARING,CAM SW:FRONT & REAR	80009	401-0180-00
	200-1227-01			1	..COVER,CAM SW:3 & 24 ELEMENTS,ALUMINUM(ATTACHING PARTS).....	80009	200-1227-01
	211-0292-00			6	..SCR,ASSEM WSHR:4-40 X 0.29,BRS NI PL(END ATTACHING PARTS).....	78189	51-040445-01
-102	337-1754-00			4	..SHIELD,ELEC:ATTENUATOR(ATTACHING PARTS).....	80009	337-1754-00
-103	213-0120-00			12	..SCR,TPG,THD FOR:2-32 X 0.250 INCH,PNH STL	83385	ORD BY DESCR
-104	210-0053-00			12	..WASHER,LOCK:#2 SPLIT,0.02THK STL CAD PL		ORD BY DESCR
-105	210-1110-00			12	..WASHER,FLAT:0.092 ID X 0.14 OD BRS(END ATTACHING PARTS).....	86928	ORD BY DESCR
-106	-----			2	..CKT BOARD ASSY:READOUT(SEE A1A3 REPL)		
-107	131-1031-00			16	..CONTACT ASSY,EL:CAM SWITCH, TOP	80009	131-1031-00
-108	210-3082-00			16	..EYELET,METALLIC:0.047 OD X 0.133 L,BRASS	80009	210-3082-00
-109	131-0608-00			20	..TERMINAL,PIN:0.365 L X 0.025 PH BRZ GOLD	22526	48283-036
-110	361-0515-00			4	..SPACER,SWITCH:PLASTIC	80009	361-0515-00
-111	214-1190-02			2	..CPLG,SHAFT,RGD:0.125 OD TO 0.081 OD,AL	80009	214-1190-02
-112	214-1136-00			2	..ACTUATOR,SL SW:DUAL DPST	80009	214-1136-00
-113	351-0180-00			2	..SLIDE,GUIDE:SWITCH ACTUATOR	80009	351-0180-00
-114	-----			6	..CONTACT,ELEC:CKT BD SW,SPR,CU BE ..(SEE S667 REPL)		
-115	376-0152-00			2	..CPLG,SHAFT,RGD:0.075 & 0.125 ID,AL	80009	376-0152-00
-116	354-0251-00			4	..RING,COUPLING:0.251 ID X 0.375 INCH OD,AL	80009	354-0251-00
-117	376-0125-00			2	..COUPLER,CAM SW:	80009	376-0125-00
-118	376-0124-00			2	..ARM,SWITCH ACTR:DRIVER	80009	376-0124-00
-119	384-1178-00			1	EXTENSION SHAFT:0.123 OD X 6.1 INCH LONG	80009	384-1178-00
-120	384-1388-00			1	EXTENSION SHAFT:3.02 L X 0.078 OD,SST,PSVT	80009	384-1388-00
-121	386-1402-00			1	PANEL,REAR:(ATTACHING PARTS).....	80009	386-1402-00
-122	213-0793-00			4	SCREW,TPG,TF:6-32 X 0.4375,TAPTITE,FIL(END ATTACHING PARTS).....	93907	ORD BY DESCR
-123	220-0547-01			4	NUT,BLOCK:0.38 X 0.26 X 0.282 (2)4-40(ATTACHING PARTS).....	000FW	ORD BY DESCR
-124	211-0105-00			4	SCREW,MACHINE:4-40 X 0.188,100 DEG,FLH ST(END ATTACHING PARTS).....	83385	ORD BY DESCR
-125	426-0736-00			1	FR SECT,PLUG-IN:TOP	80009	426-0736-00
-126	426-0737-00			1	FR SECT,PLUG-IN:BOTTOM	80009	426-0737-00
-127	175-7208-00			1	CA ASSY,SP,ELEC:2,26 AWG,3.0 L,RIBBON	80009	175-7208-00
-128	352-0169-08			2	..HLDR,TERM CONN:2 WIRE,GRAY	80009	352-0169-08
-129	175-7209-00			1	CA ASSY,SP,ELEC:2,26 AWG,10.0 L,RIBBON	80009	175-7209-00
-130	352-0169-02			2	..HLDR,TERM CONN:2 WIRE,RED	80009	352-0169-00
-131	175-7210-00			1	CA ASSY,SP,ELEC:3,26 AWG,8.0 L	80009	175-7210-00
-132	352-0161-09			1	..CONN BODY,PL,EL:3 WIRE WHITE	80009	352-0161-09
-133	175-7211-00			1	CA ASSY,SP,ELEC:4,26 AWG,2.0 L,RIBBON	80009	175-7211-00
-134	352-0162-07			1	..HLDR,TERM CONN:4 WIRE,VIOLET	80009	352-0162-07
-135	175-2774-00			1	CA ASSY,SP,ELEC:5,26 AWG,3.0L	80009	175-2774-00
-136	352-0163-05			2	..HLDR,TERM CONN:5 WIRE,GREEN	80009	352-0163-05

Replaceable Mechanical Parts—7A18A

Fig. & Index No.	Tektronix Part No.	Serial/Model No.		Qty	1	2	3	4	5	Name & Description	Mfr Code	Mfr Part Number
		Eff	Dscont									
1-137	175-7212-00			1						CA ASSY,SP,ELEC:5,26 AWG,4.0 L	80009	175-7212-00
-138	352-0163-05			2						.HLDR,TERM CONN:5 WIRE,GREEN	80009	352-0163-05
-139	175-7213-00			1						CA ASSY,SP,ELEC:5,26 AWG,3.0 L,RIBBON	80009	175-7213-00
-140	352-0163-03			2						.HLDR,TERM CONN:5 WIRE,ORANGE	80009	352-0163-03
-141	175-2582-00			1						CA ASSY,SP,ELEC:6,26 AWG,3.0 L,RIBBON	80009	175-2582-00
-142	352-0164-00			2						.HLDR,TERM CONN:6 WIRE,BLACK	80009	352-0164-00
-143	175-8012-00			1						CA ASSY,SP,ELEC:9,26 AWG,5.5 L,RIBBON	80009	175-8012-00
	131-0707-00			18						.CONTACT,ELEC:22-26 AWG,BRS & CU BE GOLD	22526	47439
-144	352-0163-00			2						.HLDR,TERM CONN:5 WIRE,BLACK	80009	352-0163-00
-145	352-0164-03			2						.HLDR,TERM CONN:6 WIRE,ORANGE	80009	352-0164-03

FIG. 1 EXPLODED VIEW

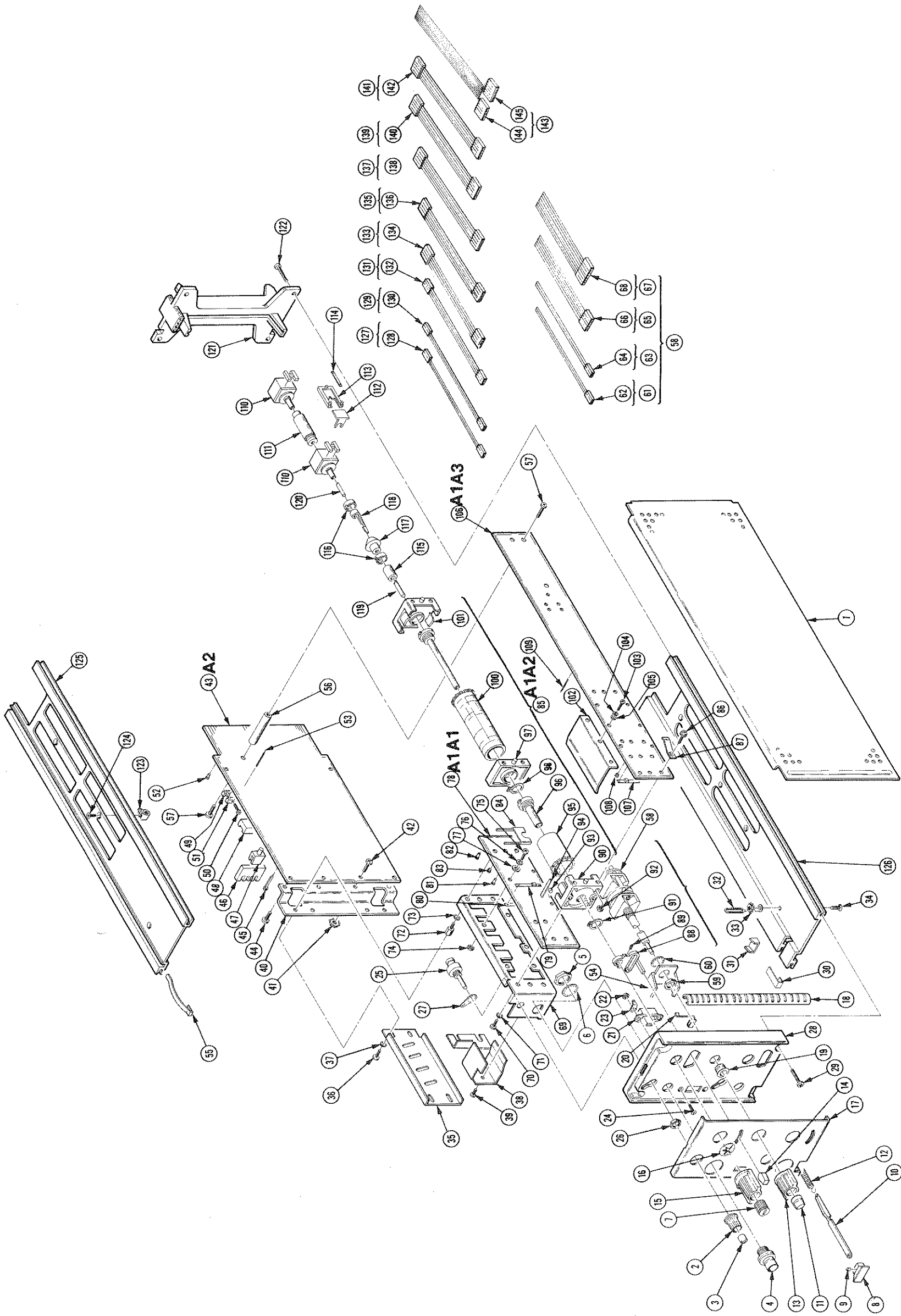

7A18A DUAL TRACE AMPLIFIER

REV SEP 1983

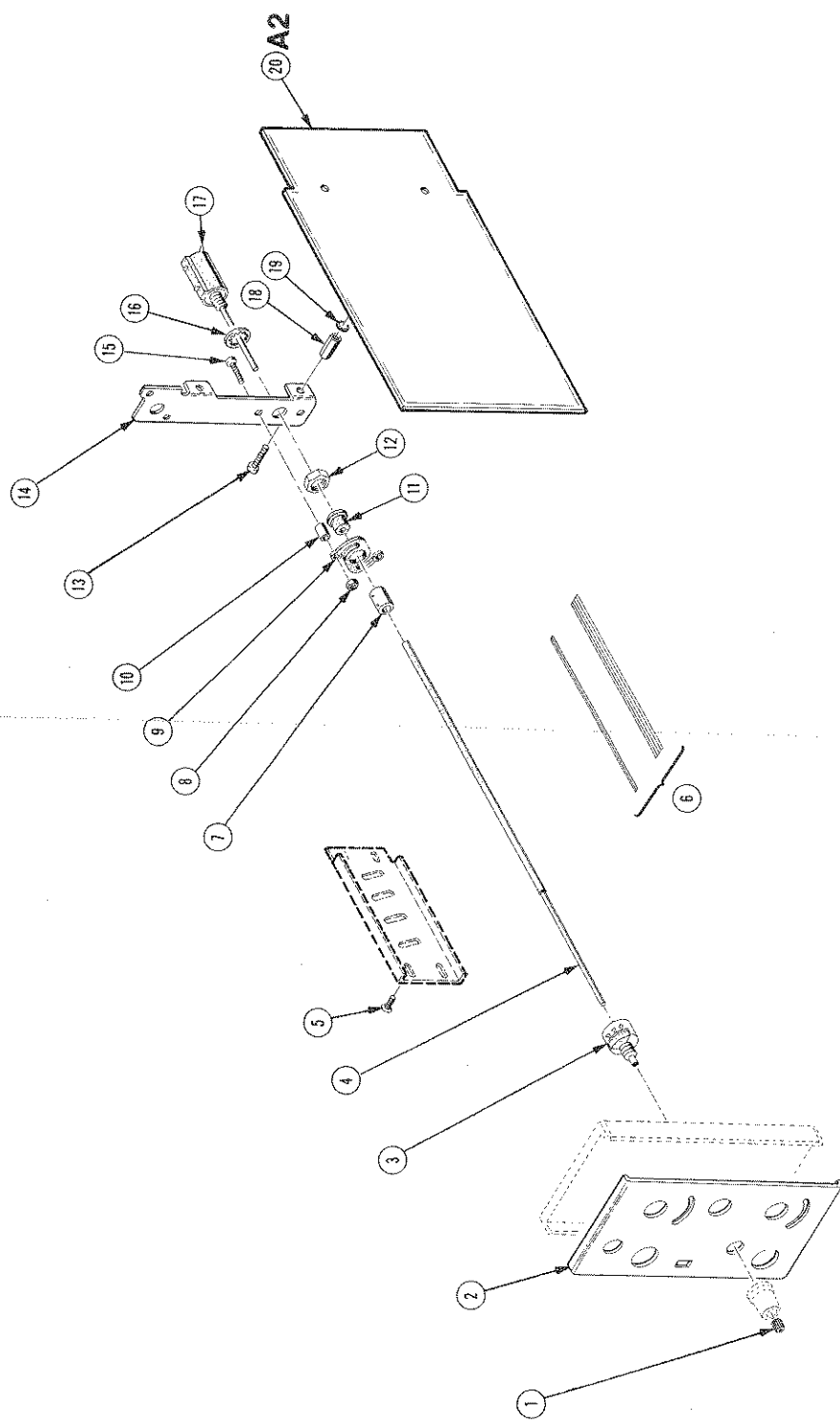

Fig. & Index No.	Tektronix Part No.	Serial/Model No.		Qty	1 2 3 4 5	Name & Description	Mfr	
		Eff	Dscont				Code	Mfr Part Number
2-1	366-1319-02			2		KNOB:GY,0.79 ID,0.28 OD,0.32 H	80009	366-1319-02
	213-0075-00			2		.SETSCREW:4-40 X 0.094,STL BK OXD,HEX	000BK	ORD BY DESCR
-2	333-1411-02			1		PANEL,FRONT:	80009	333-1411-02
-3	-----			2		RESISTOR,VAR:(SEE R11,R21 REPL)		
-4	384-1313-00			2		EXTENSION SHAFT:9.85 X 0.123 OD,EPOXY GLAS	T0588	ORD BY DESCR
-5	211-0101-00			4		SCREW,MACHINE:4-40 X 0.25,FLH,100 DEG,STL	83385	ORD BY DESCR
-6	195-0226-00			2		WIRE SET,ELEC:	80009	195-0226-00
-7	376-0039-00			2		ADPT,SHAFT,CPLG:0.128 AND 0.082"DIA SHAFT	80009	376-0039-00
-8	210-0405-00			4		NUT,PLAIN,HEX:2-56 X 0.188,BRS,CD PL	73743	12157-50
-9	426-0261-00			2		MOUNT,RESILIENT:	80009	426-0261-00
-10	166-0251-00			4		SPACER,SLEEVE:0.125 ID X 0.297 INCH LONG	80009	166-0251-00
-11	105-0296-00			2		BRAKE,SHAFT:VARIABLE RESISTOR	80009	105-0296-00
-12	210-0583-00			2		NUT,PLAIN,HEX:0.25-32 X 0.312 INCH,BRS	73743	2X20317-402
-13	211-0008-00	B010100	B011599	2		SCREW,MACHINE:4-40 X 0.250,PNH,STL,POZ	83385	ORD BY DESCR
	213-0810-00	B011600		2		SCREW,TPG,TR:4-20 X 0.75 L,PNH,STL,CD PL	93907	ORD BY DESCR
-14	407-1566-00			1		BRKT,ANGLE:VAR RESISTOR,ALUMINUM	80009	407-1566-00
-15	211-0081-00			4		SCREW,MACHINE:2-56 X 0.562,PNH STL	83385	ORD BY DESCR
-16	210-0046-00			2		WASHER,LOCK:0.261 ID,INTL,0.018 THK,BRS	77900	1214-05-00-0541C
-17	-----			2		RESISTOR,VAR:(SEE R12,R22 REPL)		
-18	129-0299-00	B010100	B011599	2		POST,ELEC-MECH:HEX,0.333 INCH LONG	80009	129-0299-00
	166-0026-00	B011600		2		SPACER,SLEEVE:0.375 L X 0.125 ID,AL	71590	P7610-1
-19	210-0004-00			2		WASHER,LOCK:#4 INTL,0.015 THK,STL CD PL	77900	1204-00-000541C
-20	-----			1		CKT BOARD ASSY:AMPLIFIER(SEE A2 REPL)		

Tektronix Part No.	Serial/Model No. Eff	Dscont	Qty	1	2	3	4	5	Name & Description	Mfr Code	Mfr Part Number
-----------------------	-------------------------	--------	-----	---	---	---	---	---	--------------------	-------------	-----------------

STANDARD ACCESSORIES

070-4329-00			1						MANUAL, TECH: INSTRUCTION	80009	070-4329-00
-------------	--	--	---	--	--	--	--	--	---------------------------	-------	-------------

7A18A DUAL TRACE AMPLIFIER



MANUAL CHANGE INFORMATION

At Tektronix, we continually strive to keep up with latest electronic developments by adding circuit and component improvements to our instruments as soon as they are developed and tested.

Sometimes, due to printing and shipping requirements, we can't get these changes immediately into printed manuals. Hence, your manual may contain new change information on following pages.

A single change may affect several sections. Since the change information sheets are carried in the manual until all changes are permanently entered, some duplication may occur. If no such change pages appear following this page, your manual is correct as printed.

0
1
2
3
4
5
6
7
8
9

0

Free Manuals Download Website

<http://myh66.com>

<http://usermanuals.us>

<http://www.somanuals.com>

<http://www.4manuals.cc>

<http://www.manual-lib.com>

<http://www.404manual.com>

<http://www.luxmanual.com>

<http://aubethermostatmanual.com>

Golf course search by state

<http://golfingnear.com>

Email search by domain

<http://emailbydomain.com>

Auto manuals search

<http://auto.somanuals.com>

TV manuals search

<http://tv.somanuals.com>