



**PLEASE CHECK FOR CHANGE INFORMATION
AT THE REAR OF THIS MANUAL.**

**AM 502
DIFFERENTIAL
AMPLIFIER**

Francais Deutsch 日本語

INSTRUCTION MANUAL

**Tektronix, Inc.
P.O. Box 500
Beaverton, Oregon 97077**

Serial Number _____

070-1582-01
Product Group 75

**First Printing MAY 1983
Revised OCT 1986**

Copyright © 1973, 1978 Tektronix, Inc. All rights reserved. Contents of this publication may not be reproduced in any form without the written permission of Tektronix, Inc.

Products of Tektronix, Inc. and its subsidiaries are covered by U.S. and foreign patents and/or pending patents.

TEKTRONIX, TEK, SCOPE-MOBILE, and  are registered trademarks of Tektronix, Inc.

Printed in U.S.A. Specification and price change privileges are reserved.

Copyright © 1973, 1978 durch Tektronix, Inc. Alle Rechte vorbehalten. Der Inhalt dieser Publikation darf ohne Genehmigung von Tektronix, Inc. nicht weitergegeben werden.

Produkte von Tektronix, Inc. und seinen Tochtergesellschaften sind durch US- und Auslandspatente und/oder schwebende Patente abgedeckt.

TEKTRONIX, TEK, SCOPE-MOBILE und  sind geschützte Warenzeichen von Tektronix, Inc.

Gedruckt in U.S.A. Spezifikations- und Preisänderungen bleiben vorbehalten.

Copyright © 1973, 1978 TEKTRONIX INC. Tous droits réservés. Le contenu de ce manuel ne peut être reproduit sous quelque forme que ce soit sans l'accord de Tektronix Inc.

Tous les produits TEKTRONIX sont brevetés US et Etranger et les logotypes TEKTRONIX, TEK SCOPE MOBILE,  sont déposés.

Imprimé aux USA. TEKTRONIX se réserve le droit de modifier : caractéristiques et prix dans le cadre de développements technologiques.

© 1973, 1978 年版權所有テクトロニクス社。不許複製。

TEKTRONIX、TEK、SCOPE-MOBILE、 はテクトロニクス社の登録商標です。

米国にて印刷。仕様及び価格は予告なく変更する場合があります。

INSTRUMENT SERIAL NUMBERS

Each instrument has a serial number on a panel insert, tag, or stamped on the chassis. The first number or letter designates the country of manufacture. The last five digits of the serial number are assigned sequentially and are unique to each instrument. Those manufactured in the United States have six unique digits. The country of manufacture is identified as follows:

| | |
|---------|--|
| B000000 | Tektronix, Inc., Beaverton, Oregon, USA |
| 100000 | Tektronix Guernsey, Ltd., Channel Islands |
| 200000 | Tektronix United Kingdom, Ltd., London |
| 300000 | Sony/Tektronix, Japan |
| 700000 | Tektronix Holland, NV, Heerenveen, The Netherlands |

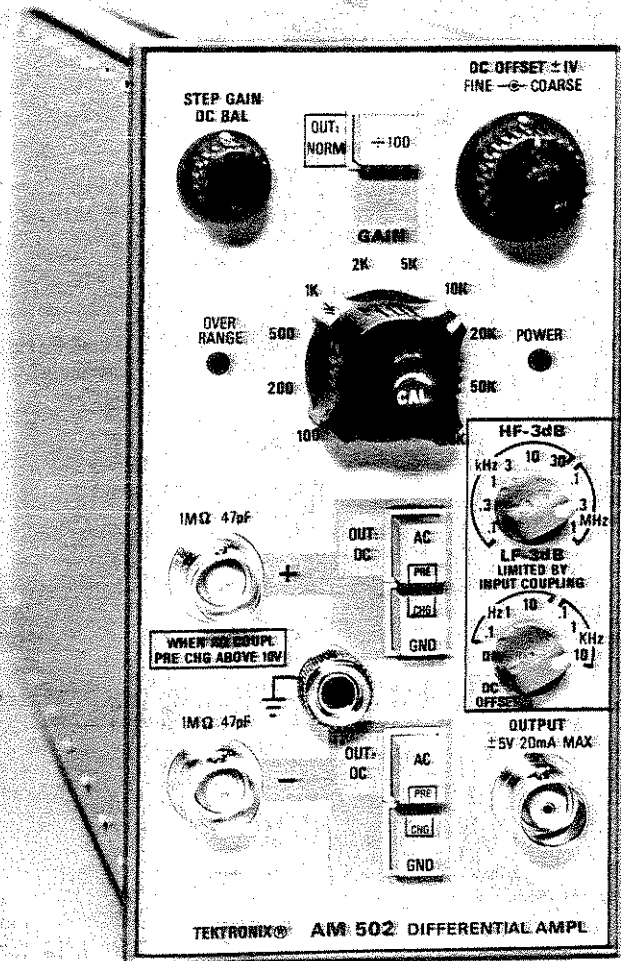

1582-1

AM 502 Differential Amplifier plug-in module.

OPERATING INSTRUCTIONS

INTRODUCTION

Description

The AM 502 is a dc-coupled differential amplifier with excellent common-mode rejection capabilities and high gain for low voltage measurements. The dc offset capability permits nulling up to 1 volt dc, so that low level, low frequency signals impressed on a dc level can be amplified without the degradation often introduced by ac input coupling. High and low frequency -3 dB points can be selected at the front panel to suit the application. Signal inputs and outputs are available at the rear connector as well as at the front panel. A front panel lamp indicates most overrange conditions of excessive input signal, excessive gain, or excessive offset.

The input circuit can be represented by approximately 1 megohm to ground paralleled by approximately 47 picofarads. The input impedance can be raised to about 200 megohms with the removal of a jumper.

Overload protection is provided by fuses in series with the input which open when large amounts of current flow due to overloading conditions.

A STEP GAIN DC BALANCE control is provided to adjust for zero shift as the gain switch is changed from one position to another.

The DC OFFSET COARSE and FINE controls give offset up to ± 1 volt dc potential difference at the input connectors. The amplifier internal bias is changed to accomplish the offset. The LF -3 dB switch must be in the DC OFFSET position to actuate these controls.

The HF -3 dB switch is used to reduce the upper bandwidth limit as necessary to improve the signal-to-noise ratio when using the AM 502 in low-frequency applications. The LF -3 dB control increases the lower bandwidth frequency.

Use of the pre-charging feature prevents surge currents, due to charging the ac coupling capacitor, from damaging the circuit under test.

Installation and Removal

CAUTION

Turn the power module off before inserting the plug-in; otherwise, damage may occur to the plug-in circuitry. Because of the high current drawn by the AM 502, it is also recommended that the power module be turned off before removing the AM 502. Refer to Fig. 1-1. Check to see that the plastic barriers on the interconnecting jack of the selected power module compartment match the cut-outs in the AM 502 circuit board edge connector.

Align the AM 502 chassis with the upper and lower guides of the selected compartment. Push the module in and press firmly to seat the circuit board in the interconnecting jack.

To remove the AM 502, pull on the release latch located in the lower left corner, until the interconnecting jack disengages and the AM 502 will slide out.

Controls and Connectors

Refer to Fig. 1-2. Even though the AM 502 is fully calibrated and ready to use, the functions and actions of the controls and connectors should be reviewed before attempting to use it. Pull the Power switch on the power module to apply power to the AM 502. The POWER indicator light indicates when power is applied to the AM 502.

OPERATING CONSIDERATIONS

Overheating

The AM 502 is designed to operate at an ambient temperature from 0° to $+50^{\circ}$ C. However, when operating several power supplies in a multi-plug-in power module, especially at low output voltages, or when operating close to other heat-producing equipment, internal temperature may exceed safe limits and actuate a thermal cutout in the power module. Refer to the power module instruction manual for more complete information.

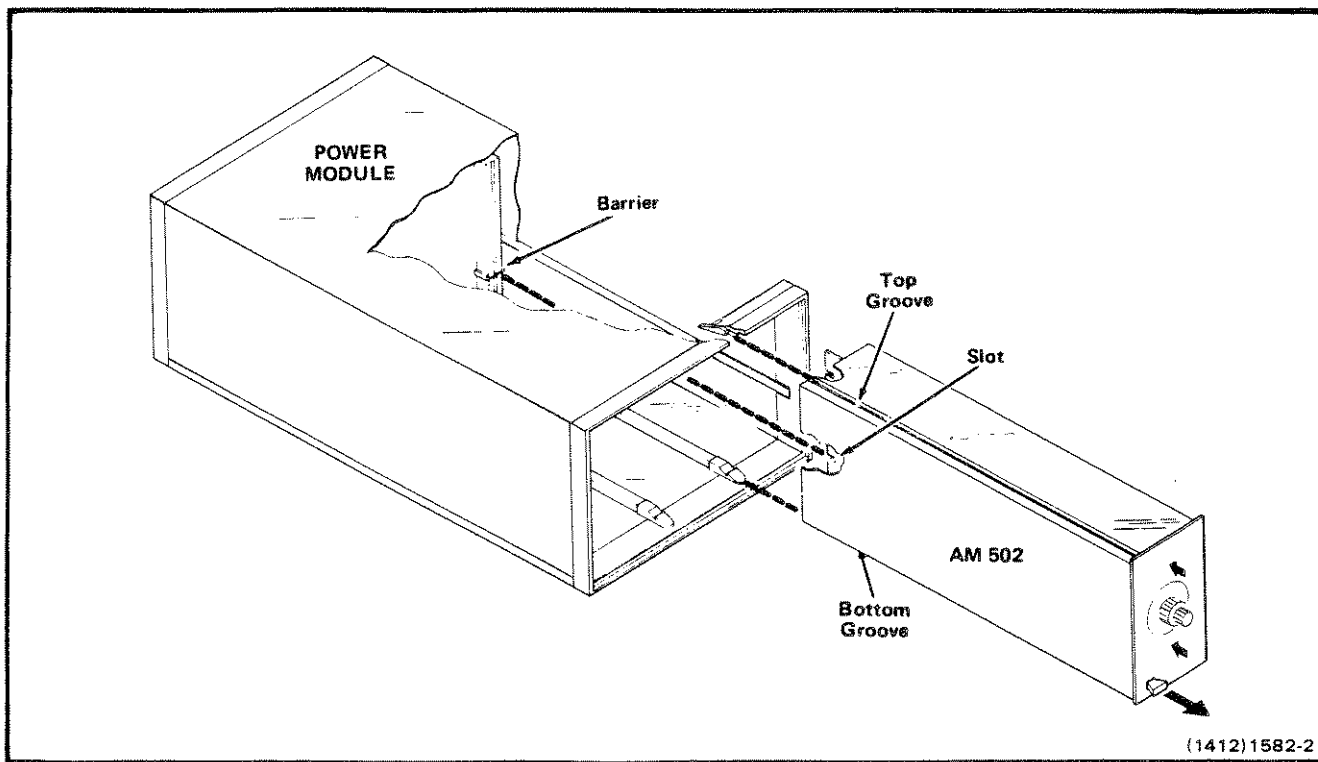

Fig. 1-1. Plug-in installation and removal.

Input Connections

Unshielded test leads can be used to connect the AM 502 to a signal source when a high-level, low-frequency signal is monitored at a low impedance point. However, when any of these factors is missing, it becomes increasingly important to use shielded signal cables. In all cases, the signal-transporting leads should be kept as short as practical.

When making single-ended input measurements (conventional amplifier operation), be sure to establish a common ground connection between the device under test and the AM 502. The shield of a coaxial cable is normally used for this purpose. See Fig. 1-3 for reference. Push the GND button for the input not connected to the device under test.

In some cases differential measurements require no common chassis ground connection, and therefore are less susceptible to interference by ground-loop currents.

Consider the change in the source operating characteristics due to loading by the signal input cables. The circuit at the input connectors can be represented by approximately 1 megohm to ground paralleled by approximately 47 picofarads. Two feet of 50 ohm coaxial cable increases the parallel capacitance by about 60 picofarads, which could be excessive in many situations. To minimize these effects, use a higher impedance cable or an attenuator probe.

Probes

Attenuator probes decrease the resistive-capacitive loading of a signal source. They also extend the measurement range of the AM 502 to substantially higher voltages. Some measurements require a higher resistance input to the AM 502, with very little source loading or signal attenuation. In such situations use a FET probe or the high-impedance input provision of the AM 502. Contact your Tektronix Representative for further information on probes.

High Impedance Input

To raise the internal input impedance of the AM 502 to about 200 megohms, remove the P40 plug (Fig. 3-1). Make certain the attenuator is in the NORM mode. Signal source impedance now becomes an important factor. For example, a 100 picoampere gate current through 10 megohms produces a one-millivolt offset. This offset may result in significant error when small voltages are measured.

Input Overloading

When measuring unknown dc voltages, push the $\div 100$ pushbutton in, and start with the 100 position on the GAIN switch. Increase the GAIN switch setting and finally release the $\div 100$ pushbutton until a suitable output signal is obtained. If the input circuit of the AM 502 is overdriven, large amounts of current will flow, opening the protective fuses.

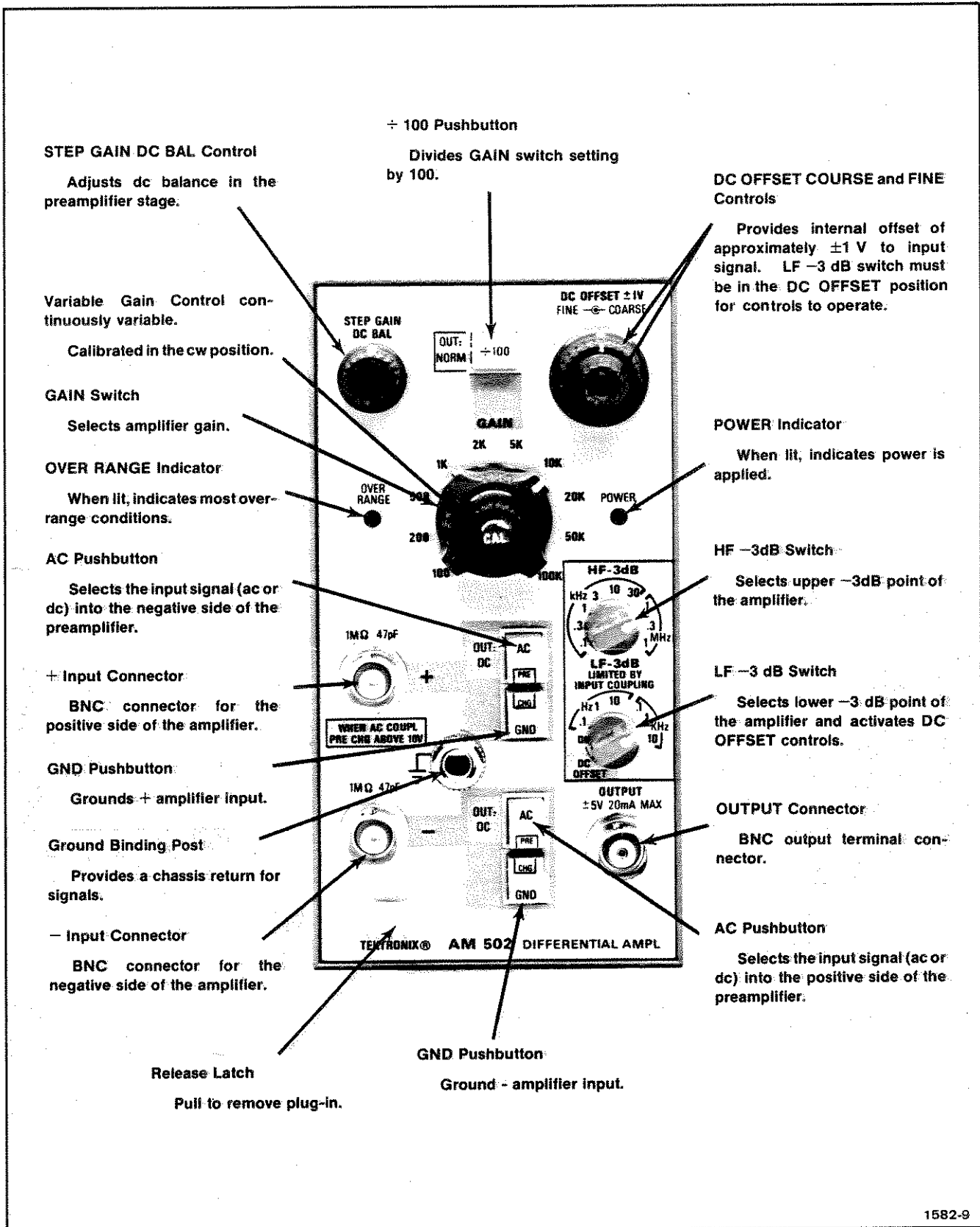

1582-9

Fig. 1-2. AM 502 controls and connectors.

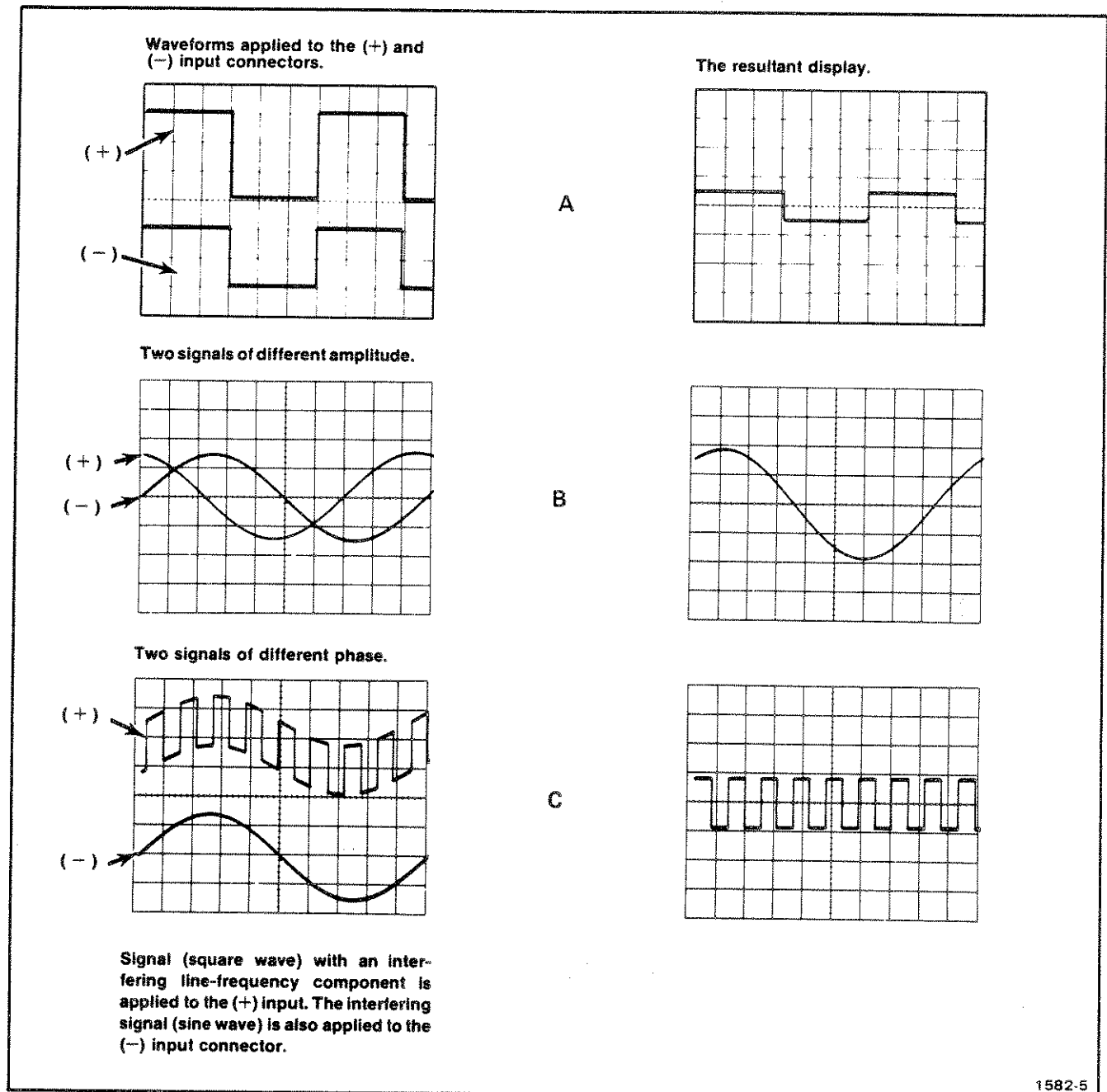

Fig. 1-3. Waveforms showing differential rejection of a common-mode signal. Resultant waveforms show the difference between the two signals.

Output Connections

Make output connections using a bnc to dual binding post connector, or a coaxial cable with at least one bnc connector. To prevent current limiting in the output stage, do not load the output with less than 250 ohms. Output current is limited to 20 milliamperes.

Step Gain DC Balance

If this control is misadjusted, the dc output level will shift as the GAIN switch position is changed. Push both GND buttons and place the GAIN switch in the 100 position. Rotate the GAIN switch from stop to stop while adjusting the STEP GAIN DC BAL control for no dc shift at the OUTPUT terminal.

DC Offset Coarse and Fine

Use these controls to offset up to ± 1 volt dc potential difference at the input connectors. The amplifier internal bias is changed to accomplish the offset. The differential rejection capabilities of the AM 502 are not affected. The LF -3dB switch must be in the DC OFFSET position to activate these controls.

HF and LF Bandwidth Reduction

Use the HF -3dB switch to reduce the upper bandwidth limit, as necessary, to improve the signal-to-noise ratio when using the AM 502 in low-frequency applications. The LF -3dB control increases the lower bandwidth frequency. Use this control to reduce dc drift, when raising the lower bandwidth does not undesirably reduce the bandwidth for the signal being measured.

Pre-Charging

Use of this feature prevents surge currents, due to charging the ac coupling capacitor in the AM 502, from damaging the circuit under test. Before connecting the AM 502 to a signal containing a dc component, push the AC and GND pushbuttons. Connect the input to the circuit under test. Wait about one second for the coupling capacitor to charge. Release the GND pushbutton, and the coupling capacitor is charged to the value of the dc voltage to be measured.

Differential Operation

A differential measurement is made by connecting each of the two inputs to selected points in the test circuit. The input to the amplifier will then be the difference in voltage of the two selected points. Consideration should be given to the proper connection method used between the AM 502 and the circuit under test; otherwise improper measurement results may occur. See Fig. 1-4 for reference.

Differential voltage measurements are made by applying the signals to the +input and -input connectors. Set the input coupling switches to the same position, AC or DC, depending on the measurement being made. In differential measurements, only the voltage difference between the two signals is amplified. Common mode signals (common in amplitude, phase, and frequency) are rejected. See Fig. 1-3 A, B, and C for reference.

Single-ended measurements often yield unsatisfactory results because of the interference resulting from ground-loop currents between the AM 502 and the device under test. In other cases, it may be desirable to eliminate a dc voltage by means other than the use of a blocking

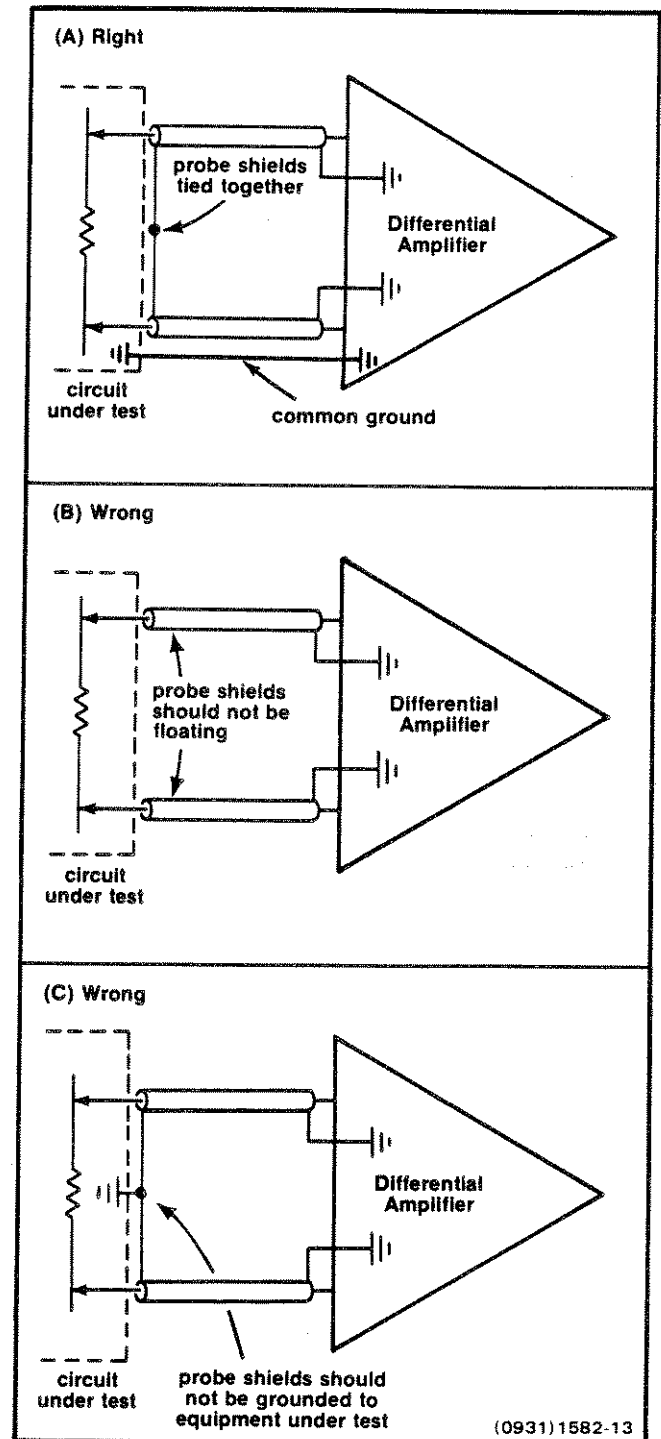

Fig. 1-4. Connecting a differential amplifier to a signal source.

capacitor, which could limit the low-frequency response. The limitations of single-ended measurements are effectively eliminated by using differential measurements.



SPECIFICATION AND PERFORMANCE CHECK

SPECIFICATION

Performance Conditions

The electrical characteristics are valid only if the AM 502 has been calibrated at an ambient temperature between +20°C and +30°C and is operating at an ambient temperature between 0°C and +50°C unless otherwise noted.

Items listed in the Performance Requirements column of the Electrical Characteristics are verified by completing the Performance Check in this manual. Items listed in the Supplemental Information column are not verified in this manual; they are either explanatory notes or performance characteristics for which no limits are specified.

Table 2-1

ELECTRICAL CHARACTERISTICS

| Characteristics | Performance Requirements | Supplemental Information |
|--------------------|--|---|
| Gain | | |
| Normal Mode | 100 to 100,000 within 2%, 10 steps in 1, 2, 5 sequence. | |
| ÷100 Mode | 1 to 1000 within 2%. | |
| Variable Range | | Continuously variable uncalibrated gain to at least 2.5 times the calibrated gain setting. |
| Frequency Response | | |
| Direct Coupled | dc to 1 MHz | With Gain control set to 20K or less, selectable HF -3dB points are within +1dB, -2dB. Upper -3dB point reduces to 500 KHz at 50K gain, and 250 KHz at 100K gain. |
| AC Coupled | 2 Hz or less, at lower frequency -3dB point to 1 MHz. | |
| Bandwidth | | |
| HF -3dB | 100 Hz to 1 MHz, 9 steps in 1-3 sequence. | Reference approximately 5.0 V peak-to-peak output at 1 KHz. |
| Accuracy | +1dB, -2dB | Reading range -2dB to -5dB. |
| LF -3dB | 0.1 Hz to 10 kHz 6 steps in 1-10 sequence. | |
| Accuracy | +1dB, -2dB | Reading range -2dB to -5dB. |

Table 2-1 (Con't)

| Characteristics | Performance Requirements | Supplemental Information |
|---|--|--|
| Output | | |
| Voltage Swing | ± 5 V. | |
| Current | | ± 20 mA |
| R_o | | 5 Ω or less |
| Minimum Load Impedance | | 250 Ω |
| Common Mode | | |
| Normal Mode Range | ± 5 V. | |
| Rejection Range | 100 dB, dc to 50 kHz. | Direct coupled with inputs shorted together. |
| $\div 100$ Mode Range | ± 50 V. | |
| Rejection Range | 50 dB, dc to 50 kHz. | Direct coupled with less than 100 V peak-peak sine-wave input. |
| DC Offset Range | | At least + and - 1 V. |
| Maximum Safe Input Voltage | | |
| Direct Coupled Normal Mode | | 15 V (dc plus peak ac) to 5 MHz or less. |
| $\div 100$ Mode | | 350 V (dc plus peak ac) to 5 MHz or less. |
| AC Coupled | | 350 V (dc plus peak ac) with coupling capacitor precharged. |
| Maximum Input Gate Current (each input) | | 50 pA at 25°C. |
| Noise (Referred to Input) | | |
| NORM mode | ≤ 25 μ V, tangentially measured with 25 Ω or less source resistance. | 10 Hz to 1 MHz selected bandwidth. Typically ≤ 6.0 nV/ $\sqrt{\text{Hz}}$ above 1 kHz. |
| $\div 100$ Mode | | Typically ≤ 2.0 μ V/ $\sqrt{\text{Hz}}$ from 1 kHz to 9 kHz, decreasing in a 1/F fashion to ≤ 600 nV/ $\sqrt{\text{Hz}}$ above 30 kHz. |
| Voltage Drift with Time | | |
| Short Term | | 10 μ V (peak-to-peak) per hour |

Table 2-1 (cont)

| Characteristics | Performance Requirements | Supplemental Information |
|--------------------------------|--------------------------|---|
| Long Term | | 20 μ V (peak-to-peak) per hour. |
| Voltage Drift with Temperature | | 100 μ V per $^{\circ}$ C. |
| Input R and C | | Resistance, 1 M Ω . Capacitance, Approximately 47 pF. |

Table 2-2
ENVIRONMENTAL

| Characteristics | Information |
|-----------------------------|---|
| Temperature | |
| Operating | 0 $^{\circ}$ C to +50 $^{\circ}$ C |
| Storage | -40 $^{\circ}$ C to +75 $^{\circ}$ C |
| Altitude | |
| Operating | To 15,000 feet; maximum operating temperature decreased by 1 $^{\circ}$ C/1000 feet from 5000 to 15,000 feet. |
| Storage | To 50,000 feet. |
| Vibration | |
| Operating and Non-operating | With the instrument complete and operating, vibration frequency swept from 10 to 55 to 10 Hz at 1 minute per sweep. Vibrate 15 minutes in each of the three major axes at 0.015 inch total displacement. Hold 10 minutes at any major resonance, or in none, at 55 Hz. Total time 75 minutes. |
| Shock | |
| Operating and Non-operating | 30 g's 1/2 sine, 11 ms duration, 2 shocks in each direction along 3 major axes, for a total of 18 shocks. |

Table 2-3
PHYSICAL CHARACTERISTICS

| Characteristics | Information |
|---|--------------------------------|
| Overall Dimensions (measured at maximum points) | |
| Height | 5.0 inches 12.7 centimeter |
| Width | 2.5 inches 6.35 centimeter |
| Length | 11.8 inches 30.0 centimeter |
| Net Weight (Instrument Only) | 1.8 lbs. .82 kilograms |

PERFORMANCE CHECK

Introduction

This procedure checks the electrical characteristics of the AM 502 that appear in the Specification section of this manual. If the instrument fails to meet the requirements given in this performance check, the calibration procedure should be performed. This procedure can also be used by an incoming inspection facility to determine acceptability of performance.

The electrical characteristics in Section 2 are valid only if the AM 502 is calibrated at an ambient temperature of +20° C to +30° C and operated at an ambient temperature of 0° C to +50° C. Forced air circulation is required for ambient temperature above +40° C.

Tolerances that are specified in this performance check procedure apply to the instrument under test and do not include test equipment error.

Test Equipment Required

The following test equipment, or equivalent, is required to perform the performance check. Test equipment characteristics listed are the minimum required to verify the performance of the equipment under test. Substitute equipment must meet or exceed the stated requirements. All test equipment is assumed to be operating within tolerances.

Special test devices are used where necessary to facilitate the procedure. Most of these are available from Tektronix, Inc. and can be ordered through your local Tektronix Field Office or representative.

Table 2-4

LIST OF TEST EQUIPMENT REQUIREMENTS

| Description | Performance Requirements | Applications | Example |
|------------------------------|---|---|--|
| Oscilloscope | Bandwidth, dc to 2 MHz; Minimum deflection factor, 20 mV/div; sweep rate, .2 ms/div to 1 μ s/div; accuracy, within 3%. | Used throughout procedure to provide display. | TEKTRONIX 5110. 5A13N, 5B10N. |
| Power Module | Three compartments or more. | All tests | TEKTRONIX TM 503 or TM 504. |
| Calibration Generator | Amplitude calibration, 5 mV to 10 V; accuracy, $\pm 0.25\%$ into 1 M Ω ; output, square wave at approximately 1 kHz. | Amplifier gain check | TEKTRONIX PG 506 Calibration Generator. ^a |
| Function Generator | Waveforms, sine and square; voltage amplitude, 10 V p-p; frequency range, 1 kHz to 50 kHz; accuracy, within 3%. | Signal generation for cross neutralization and high frequency cmrr check. | TEKTRONIX FG 501 Function Generator. ^a |
| Termination | Impedance, 50 Ω ; accuracy, within 2%; connectors, bnc. | Output termination for signal generator. | Tektronix Part No. 011-0049-01 |
| Attenuator, 10X (4 required) | Impedance, 50 Ω ; accuracy, within 2%; connectors, bnc. | Output attenuation for signal generator. Noise check. | Tektronix Part No. 011-0059-02 |
| Coaxial cable (2 required) | Impedance, 50 Ω ; length, 36 inches; connectors, bnc. | Provides signal interconnection. | Tektronix Part No. 012-0057-01 |

^a Requires TM 500-Series power module

Preliminary Procedure

1. Ensure that all test equipment and the AM 502 under test are suitably adapted to the line voltage to be applied. Refer to the installation section of the power module manual.

2. Ensure that all test equipment is suitably adapted to the applied line voltage.

3. Install the AM 502 into the power module, and if applicable, install the TM 500 series test equipment into the test equipment power module.

4. Connect the equipment under test and the test equipment to a suitable line voltage source. Turn all equipment on and allow at least 20 minutes for the equipment to stabilize.

Initial Control Settings

Set the following controls during warm-up time:

AM 502

| | |
|------------------|-----------------------|
| STEP GAIN DC BAL | midrange |
| ÷100 | pushbutton out |
| DC OFFSET | |
| FINE and COARSE | midrange |
| GAIN | 100 |
| CAL | fully clockwise (cal) |
| HF -3dB | 1 MHz |
| LF -3dB | DC OFFSET |
| + AC | pushbutton out |
| + GND | pushbutton out |
| - AC | pushbutton out |
| - GND | pushbutton in |

Oscilloscope

Intensity, Focus Set for well-defined trace and normal brightness.

Vertical Amplifier

| | |
|-----------|-----------------------|
| Volts/Div | 1 V |
| + Input | dc |
| Variable | fully clockwise (cal) |

Time Base Plug-In

| | |
|--------------|--|
| Time/Div | .5 ms |
| Variable | (cal in) |
| Triggering | |
| + Slope | selected |
| Mode | p-p auto |
| Coupling | ac |
| Source | internal |
| Position | Set so trace starts at left side of graticule. |
| Display Mode | main sweep |
| Magnifier | X1 |

Calibration Generator

| | |
|-----------|-----|
| Amplitude | 1 V |
|-----------|-----|

PERFORMANCE CHECK PROCEDURE

NOTE

The oscilloscope vertical amplifier system gain, the 50-ohm termination, and 50-ohm attenuator are required to be calibrated within 0.5% accuracy prior to proceeding with Steps 1 and 2. The PG 506 calibration generator may be used to set the system to 0.5% accuracy.

1. Check Amplifier Gain. Gain Accuracy is within 2%

a. Connect the calibration generator to the AM 502 + input connector through a 50-ohm cable, a 50-ohm 10X attenuator and 50-ohm terminator.

b. Connect a 50-ohm cable from the AM 502 OUTPUT connector to the vertical amplifier input connector.

c. Adjust the AM 502 DC OFFSET controls (FINE and COARSE) until the OVERRANGE indicator light goes out. Position the crt display to the center of the graticule with the vertical amplifier position control.

d. Check—using the AM 502 GAIN and calibration generator amplitude settings given in Table 2-5, check the vertical deflection within the given limits.

Specification and Performance Check—AM 502

NOTE

The OVER RANGE indicator light must remain off during all switch settings. Adjust the DC OFFSET controls as required during the check procedure.

NOTE

Install both plug-in side covers and insert plug-in into power module for checking gain below 5K setting to minimize noise on the display.

Table 2-5

AMPLIFIER GAIN ACCURACY

| AM 502 GAIN Setting | AM 502 HF -3 dB Switch Setting | Calibration Generator Amplitude Setting | Vertical Deflection in Divisions |
|---------------------|--------------------------------|---|----------------------------------|
| 100 | 1 MHz | 1 V | 4.9 - 5.1 |
| 200 | 1 MHz | .5 V | 4.9 - 5.1 |
| 500 | 1 MHz | .2 V | 4.9 - 5.1 |
| 1K | 1 MHz | .1 V | 4.9 - 5.1 |
| 2K | 1 MHz | 50 mV | 4.9 - 5.1 |
| 5K | 1 MHz | 20 mV | 4.9 - 5.1 |
| 10K | 10 kHz | 10 mV | 4.9 - 5.1 |
| 20K | 10 kHz | 5 mV | 4.9 - 5.1 |
| 50K | 10 kHz | 2 mV | 4.9 - 5.1 |
| 100K | 10 kHz | 1 mV | 4.9 - 5.1 |

2. Check $\div 100$ Amplifier Gain Accuracy. Gain Accuracy is within 2%

a. Disconnect all cables and repeat Step 1 parts a, b, c, and d.

b. Set the AM 502 GAIN switch to 10K and the HF -3 dB switch to 1 MHz; push in the $\div 100$ pushbutton.

c. Set the calibration generator amplitude control to 1 V. Adjust the AM 502 DC OFFSET control (FINE and COARSE) until the OVERRANGE indicator light goes out.

d. Position the crt display to the center of the graticule with the vertical amplifier position control.

e. Check—the crt display amplitude for 4.9 to 5.1 divisions.

f. Disconnect the 50-ohm terminator from the AM 502 + input connector and connect it to the - input connector. Push in the + input GND pushbutton and push and release the - input GND pushbutton.

g. Check—repeat parts d, e, and f of this step.

h. Disconnect the 50-ohm termination, 10X attenuator, and cable.

3. Check Common Mode Rejection. Rejection Ratio is 100 dB, dc to 50 kHz

a. Connect a dual-input connector cable between the AM 502 + input and - input connector.

b. Set the AM 502 $\div 100$ pushbutton out; the + input and - input AC and GND pushbuttons out, and the GAIN switch to 100.

c. Set the AM 502 HF -3 dB switch to .3 MHz and the LF -3 dB switch to DC.

d. Set the vertical amplifier deflection factor for 10 mV/div.

e. Connect a 50-ohm cable from the function generator to the center connector of the dual-input connector. Set the function generator for a 10 V, 50 kHz sine-wave output signal, with DC offset set to 0 at <1 V.

$$10V_{pp} = 3.535V_{RMS}$$

f. Adjust vertical amplifier position to center display on screen.

g. Check—the crt display for one division of vertical deflection or less.

4. Check $\div 100$ Common Mode Rejection. Rejection Ratio is 50 dB, dc to 50 kHz

a. Disconnect the 50-ohm cable from the function generator and connect it to the calibration generator output. Press in the $\div 100$ pushbutton.

b. Set the vertical amplifier deflection factor for 100 mV/div.

c. Set the calibration generator for a 100 volt, square-wave output signal.

d. Check—crt display for 3.1 divisions or less of vertical deflection.

e. Disconnect the dual-input connector and 50-ohm cable from the AM 502 input connectors.

5. Check HF -3 dB Bandwidth. Accuracy is +1 dB, -2 dB

a. Set the AM 502 HF -3 dB switch to 1 MHz, the - input pushbutton to GND, and +100 pushbutton out.

b. Set the vertical amplifier deflection factor to 1 V/div, and the time-base sweep rate to 1 ms/div.

c. Set the function generator controls for a 50 mV, 1 kHz sine-wave output signal. (Use appropriate attenuation to eliminate input overdrive condition.)

d. Connect a 50-ohm cable from the function generator to the AM 502 + input connector. Adjust the vertical deflection amplitude for a five-division display.

e. Set the function generator output frequency to 1 MHz.

f. Check—the amplitude of the crt display for 3.15 to 3.85 divisions.

NOTE

The specification in part f of this step must be met before proceeding with part g of this step.

g. Check—the remaining settings of the HF -3 dB switch, using Table 2-6 as reference. (Change time-base sweep rate as needed for lower frequencies.)

Table 2-6

HF -3 dB BANDWIDTH ACCURACY

| AM 502 HF -3 dB Switch Setting | Function Generator Output Frequency | Vertical Deflection in Divisions |
|--------------------------------|-------------------------------------|----------------------------------|
| .3 MHz | 300 kHz | 3.15 - 3.85 |
| .1 MHz | 100 kHz | 3.15 - 3.85 |
| 30 kHz | 30 kHz | 3.15 - 3.85 |
| 10 kHz | 10 kHz | 3.15 - 3.85 |
| 3 kHz | 3 kHz | 3.15 - 3.85 |
| 1 kHz | 1 kHz | 3.15 - 3.85 |
| .3 kHz | 300 Hz | 3.15 - 3.85 |
| .1 kHz | 100 Hz | 3.15 - 3.85 |

i. Set the HF -3 dB switch to 1 MHz.

6. Check LF -3 dB Bandwidth. Accuracy is +1 dB, -2 dB

a. Check—the settings of the LF -3 dB switch, using Table 2-7 as reference. Adjust the time-base sweep rate to obtain an appropriate display.

Table 2-7

LF -3 dB BANDWIDTH ACCURACY

| AM 502 LF -3 dB Switch Setting | Function Generator Output Frequency | Vertical Deflection in Divisions |
|--------------------------------|-------------------------------------|----------------------------------|
| 10 kHz | 10 kHz | 3.15 - 3.85 |
| 1 kHz | 1 kHz | 3.15 - 3.85 |
| .1 kHz | .1 kHz | 3.15 - 3.85 |
| 10 Hz | 10 Hz | 3.15 - 3.85 |
| 1 Hz | 1 Hz | 3.15 - 3.85 |

NOTE

The components used in the .1 Hz position are also used in the other positions of the switch; therefore, the tolerance of the .1 Hz position is checked.

b. Press in the AM 502 + input AC pushbutton. Set the function generator controls for a 2 Hz output signal.

c. Check—the amplitude of the crt display for 3.15 to 3.85 divisions.

d. Disconnect the 50-ohm cable from the AM 502 + input connector and connect it to the - input connector.

e. Press in the AM 502 + input GND pushbutton and - input AC pushbutton. Press to release the - input GND pushbutton.

f. Check—the amplitude of the crt display for 3.15 to 3.85 divisions.

g. Set the LF -3 dB switch to the DC OFFSET position. Press in the AM 502 - input GND pushbutton.

h. Disconnect the 50-ohm cable from the AM 502 - input connector.

Specification and Performance Check—AM 502

7. Check Overall Noise (Tangentially Measured)

a. Set the AM 502 GAIN control to 100K; press in to release the + input AC and GND pushbutton, and the - input AC pushbutton.

b. Set the vertical amplifier deflection factor to 5 V/div. Set the time-base sweep rate to 10 μ s/div, and the trigger source switch to external.

c. Connect a 50-ohm termination to the AM 502 + input connector; connect four series-connected 10X attenuators to the 50-ohm termination.

d. Connect a 50-ohm cable from the calibration generator fast-rise output connector to the end of the attenuator string. Set the pulse duration control for 1 ms.

e. Adjust the AM 502 DC OFFSET controls (FINE and COARSE) until the OVER RANGE indicator light goes out.

f. Adjust the calibration generator pulse amplitude control and observe two noise bands as shown in Fig. 2-1A (remove one attenuator if necessary, to produce the desired display).

g. Decrease the calibration generator pulse amplitude until the noise bands just merge. See Fig. 2-1B.

h. Remove three of the attenuators and connect the signal through the 50-ohm attenuator (including the 50-ohm termination), to the vertical amplifier input and measure the pulse amplitude. Calculate the tangentially measured display noise as follows:

$$\text{Noise (in } \mu\text{V)} = \frac{\text{Signal level (measured in part h)}}{\text{Attenuation Removed}}$$

Typical figures are:

$$\frac{12 \text{ mV}}{10^3} = 12 \times 10^{-6} = 12 \mu\text{V of noise}$$

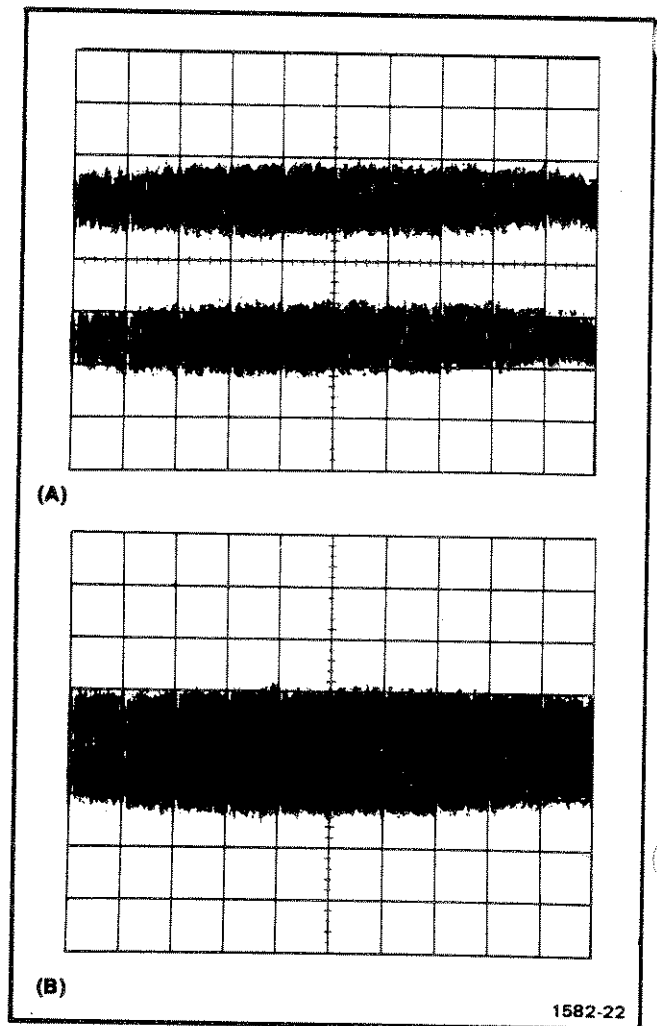

Fig. 2-1. Typical display of (A) two noise bands and (B) noise bands merged.

i. Disconnect all cables and equipment.

This completes the Performance Check of the AM 502 Differential Amplifier.

Free Manuals Download Website

<http://myh66.com>

<http://usermanuals.us>

<http://www.somanuals.com>

<http://www.4manuals.cc>

<http://www.manual-lib.com>

<http://www.404manual.com>

<http://www.luxmanual.com>

<http://aubethermostatmanual.com>

Golf course search by state

<http://golfingnear.com>

Email search by domain

<http://emailbydomain.com>

Auto manuals search

<http://auto.somanuals.com>

TV manuals search

<http://tv.somanuals.com>