

INSTRUCTION MANUAL

POWER MODULE

TM 501

Serial Number _____

WARRANTY

Tektronix warrants that this product is free from defects in materials and workmanship. The warranty period is one (1) year from the date of shipment. Tektronix will, at its option, repair or replace the product if Tektronix determines it is defective within the warranty period and if it is returned, freight prepaid, to a service center designated by Tektronix.

Tektronix is not obligated to furnish service under this warranty:

- a. to repair damage resulting from attempts by personnel other than Tektronix representatives to install, repair, or service the product;
- b. to repair damage resulting from improper use or from connecting the product to incompatible equipment;
- c. if personnel other than Tektronix representatives modify the hardware or software.

There is no implied warranty of fitness for a particular purpose. Tektronix is not liable for consequential damages.

Copyright © 1972 Tektronix, Inc. All rights reserved. Contents of this publication may not be reproduced in any form without the written permission of Tektronix, Inc.

Products of Tektronix, Inc. and its subsidiaries are covered by U.S. and foreign patents and/or pending patents.

TEKTRONIX, TEK, SCOPE-MOBILE, and  are registered trademarks of Tektronix, Inc.

Printed in U.S.A. Specification and price change privileges are reserved.

TABLE OF CONTENTS

	Page
INSTALLATION PROCEDURE	1
OPERATING INSTRUCTIONS	4
POWERING UP	4
BUILDING A SYSTEM	5
SPECIFICATIONS	6
SYSTEM MAINTENANCE	7
GENERAL	7
TROUBLESHOOTING AIDS	8
TROUBLESHOOTING TECHNIQUES	8
PARTS ORDERING AND REPLACEMENT	10
SERVICE INFORMATION	14
INTERFACE PIN ASSIGNMENTS	15
DETAILED BLOCK DIAGRAM	15
PARTS LOCATION GRID	16
ELECTRICAL PARTS LIST	17
SCHEMATIC	19
MECHANICAL PARTS LIST	20
EXPLODED VIEW DRAWING	

INSTALLATION PROCEDURE

Before you start...

1. Check the rear panel markings. If the factory settings are compatible with the available line voltage and frequency, insert the desired plug-ins. Use the bail to raise the front of the instrument.

...go to Operating Instructions...

2. If a change is needed, follow these steps:

a. Line Selector Block(s)

Remove the two hold-down screws on the top of the dust cover cabinet and lift the cabinet off. This gives easy access to the Line Selector blocks located on the main circuit board.

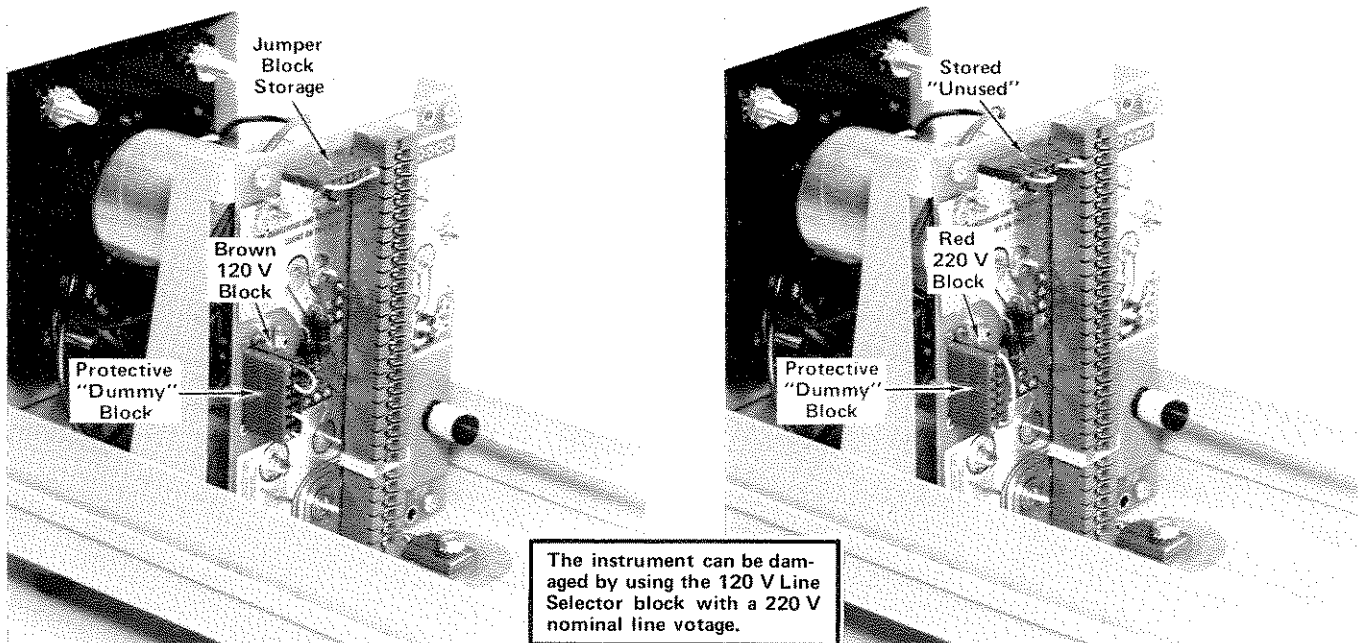

b. Line Range Taps

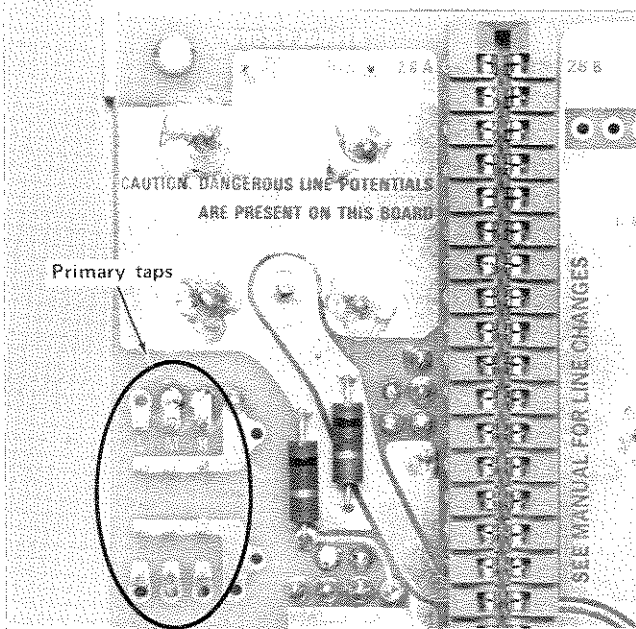

Standard Transformer (SN BO50000 - below)

Line Selector Block Position	Regulating Ranges
L Do not use	Internally disconnected
M (110 V Nominal)	99 VAC to 121 VAC
H (120 V Nominal)	108 VAC to 132 VAC

Universal Transformer (SN BO50000-up)

Line Selector Block Position	Regulating Ranges	
	120-Volts Nominal	220-Volts Nominal
L	90 VAC to 110 VAC	180 VAC to 220 VAC
M	99 VAC to 121 VAC	198 VAC to 242 VAC
H	108 VAC to 132 VAC	216 VAC to 264 VAC
Line Fuse Data	0.6 A slow-blow	0.3 A med-blow

c. Rear Panel

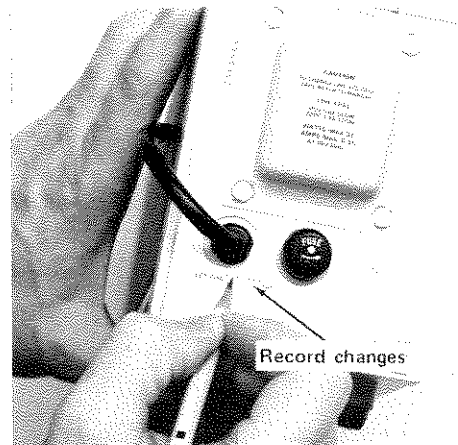
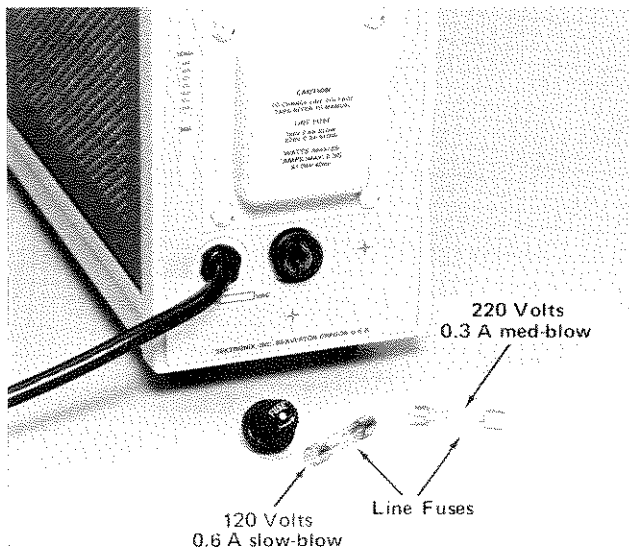

3. Replace the cabinet.
4. If necessary, change the line cord power plug to match the power source receptacle or use an adapter.
5. Plug the cord into the power source.
6. Insert the desired plug-ins.
7. Use the bail to raise the front of the instrument. **...go to Operating Instructions...**



TM 501 Power Module with plug-in.

TM 501 OPERATING INSTRUCTIONS

INTRODUCTION

Description

The TEKTRONIX TM 501 Power Module is a single-compartment wide mainframe for the TM 500 Series of Modular Instrumentation. It is a basic power source for the many plug-in module members of the TM 500 Series family. Factory options allow customer modification using signal access at the plug-in module/power module interface to provide rear panel inputs and outputs.

Power Source

This instrument is designed to operate from a power source with its neutral at or near earth (ground) potential with a separate safety-earth conductor. It is not intended for operation from two phases of a multi-phase system, or across the legs of a single-phase, three-wire system.

Power Usage

The TM 501 can require up to 35 W of power at the upper limits of the high line voltage ranges. Actual power consumption depends on the particular module and operating mode selected.

Operating Temperatures

The TM 501 is designed to operate in ambient temperatures between 0°C and +50°C. Before operating the TM 501 after storage in temperatures within the specified storage range, allow the chassis to return to room ambient before applying power.

POWERING UP

Plug-in Modules



Turn the Power Module off before inserting the plug-in; otherwise, damage may occur to the plug-in circuitry.

Module Installation

1. Check the location of the white plastic barriers on the interconnecting jack to insure that their locations match the slots in the edge of the plug-in module's circuit board.

2. Align the plug-in module chassis with the upper and lower guides of the compartment. Push the module in and press firmly to seat the circuit board in the interconnecting jack. (Remove the plug-in module by pulling on the white release latch located in the lower left corner of each module.)

3. Pull the POWER button on the right side of the TM 501. Some plug-in modules have independent power switches, usually labeled OUTPUT, controlling application of mainframe power to the module itself. Push this button to activate the plug-in module.

Loading Considerations

The TM 501 can require up to 35 W of power from the line at high-line voltage range settings. Actual power consumed, of course, depends on the particular module selected. This power capability can best be utilized by carefully planning the external loads and the resulting power distributions. Optimum conditions would dissipated as much power as possible in external loads in an ambient temperature around +25°C.

The TM 501 provides the plug-in module with access to a pair of heat-sinked, chassis-mounted transistors, one NPN and one PNP. These Series-Pass transistors allow plug-in modules to operate in power ranges not possible if the power had to be dissipated in the modules themselves.

BUILDING A SYSTEM

Family Compatibility

Mechanically, the plug-in modules are very similar to other TEKTRONIX product families. However, they are not **electrically** compatible. Therefore, the TM 501 interface has barriers on the mating connectors between pins 6 and 7 to insure that incompatible plug-ins cannot be inserted. See Figure 1. A compatible module will have a matching slot between pins 6 and 7 of its main circuit board edge connector. This slot and barrier combination is the primary keying assignment.

Another identifier for TM 500-compatible plug-in modules is the white color of the release latch.

Customizing the Interface

The modularity of this instrumentation system provides for a host of functions to be performed by the plug-in modules. Specific functions are grouped into families or classes, of which there may be several plug-in module members. For instance, some classes are Power Supplies,

Signal Sources, Measurement and so forth. Each modular member of a functional family will have a second slot peculiar to its family assignment located in its edge connector. The TM 501 user can "program" the Power Module to accept only members of a certain family by installing a second barrier in the interface connector to match the module's slot location. For extra barriers, order TEKTRONIX Part Number 214-1543-02.

Rear Panel

The rear sub-panel is punched for BNC and multi-pin connector mountings. Customer- or factory-installed connectors and wiring (see following description of catalog Option 2) could provide external access to the interface for external I/O control. This feature makes the TM 500 Series Modular Instrumentation System very flexible.

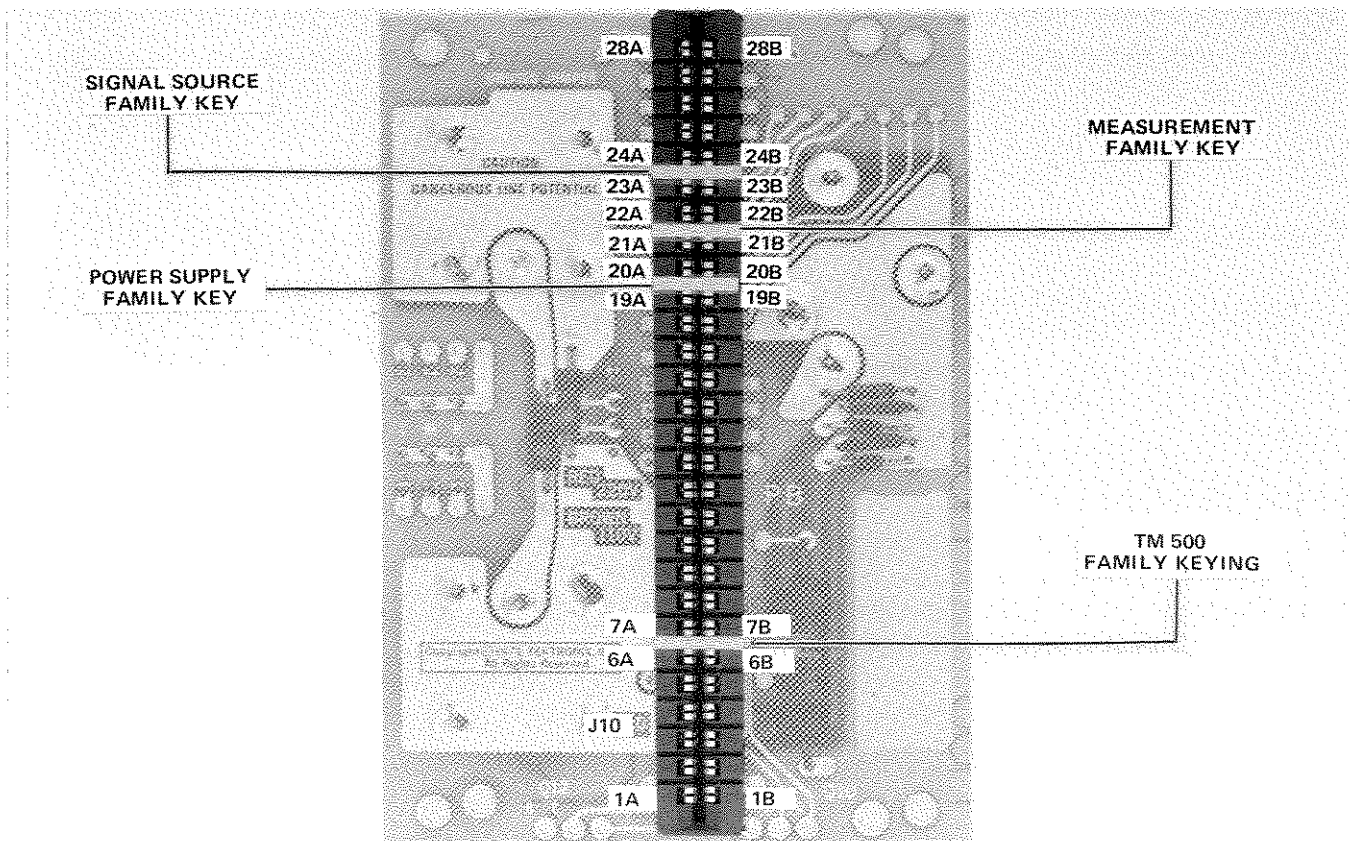

Figure 1. Keying assignments for family functions.

Option 2. This factory-installed option adds 25-mil squarepin connectors to the rear of the interconnecting jack at all pin locations from pins 14A and B through pins 28A and B. This will keep the interface flexible by making it easy and fast to change customized wiring using prepared wires with squarepin receptacles and long-nose pliers or

tweezers. It also protects the circuit board from damage by repeated soldering and unsoldering of jumper wires. This option also adds a BNC connector and a 50-pin connector to the rear panel. These connectors are **not** pre-wired in order to give a system designer as much flexibility as possible. Instead, prepared jumpers, coax cables, and interconnection jack barriers are included in a kit.

SPECIFICATIONS

Power Requirements

Line Voltage Ranges. Universal Transformer. 100, 110, 120, 200, 220, 240 VAC, all within 10%. Range changing for transformer accomplished with quick-change line-selector blocks.

Power Cord Conductor Identification

Conductor	Color	Alternate Color
Ungrounded (Line)	Brown	Black
Grounded (Neutral)	Blue	White
Grounding (Earthing)	Green-Yellow	Green-Yellow

Line Frequency Ranges. Universal Transformer: 48 Hz to 440 Hz.

Power Consumption. Maximum primary power approximately 35 W at high line. Actual power consumption depends on plug-in selection and operating modes.

Supplies (Unregulated)

Two 25 VAC windings, 500 mA each.

+33.5 V and -33.5 V, 500 mA, maximum.

17.5 VAC and +11.5 V, 1.0 A, maximum, shared in any combination between these two supplies.

NOTE

Current and voltage ratings are for main frame maintenance only. In practice, not all available power may be used at once. More detailed information is supplied with kit 040-0652-03 (TM 500-plug-in).

Temperature Range

Operating: 0°C to +50°C. Nonoperating: -40°C to +75°C.

Altitude Range

Operating: To 15,000 feet. Nonoperating: To 50,000 feet.

Other

Dimensions with Feet and Bail: H 6.0 in., W 3.9 in., L 15.3 in.

Weight without Plug-ins: Approximately 6.0 lb.



TM 501 SYSTEM MAINTENANCE

GENERAL

Introduction

This section of the manual is meant to support the entire TM 500 Series family of modules with a general coverage of the most commonly-needed service information pertinent to preventive maintenance, troubleshooting, ordering parts, and replacing components and sub-assemblies.

Cabinet Removal

WARNING

Dangerous potentials exist at several points throughout the system. When the system must be operated with the cabinet removed, do not touch exposed connections or components. Some transistors have voltages present on their cases. Disconnect power before cleaning the system or replacing parts.

Two screws on the top secure the cabinet to the TM 501 frame. Remove them and lift the cabinet straight up. Do not operate the system with the cabinet removed any longer than necessary for troubleshooting and calibration. Re-install the cabinet to protect the interior from dust and to remove personnel shock hazards.

Cleaning

CAUTION

Avoid using chemical cleaning agents which might damage plastic parts. Avoid chemicals containing benzene, toluene, xylene, acetone, or similar solvents.

Exterior. Loose dust may be removed with a soft cloth or a dry brush. Water and a mild detergent may be used; however, abrasive cleaners should not be used.

Interior. Cleaning the interior of a unit should precede calibration since the cleaning processes could alter the settings of calibration adjustments. Use low-velocity compressed air to blow off accumulated dust. Hardened dirt can be removed with a soft, dry brush, cotton-tipped swab, or a cloth dampened in a solution of water and mild detergent.

Preventive Maintenance

Preventive maintenance steps performed on a regular basis will enhance the reliability of the instrumentation system. However, periodic checks of the semiconductors in the absence of a malfunction are not recommended as preventive maintenance measures. See the semiconductor checking information under Troubleshooting Techniques which follow. A convenient time to perform preventive maintenance is just before instrument calibration.

Calibration

To insure accurate signal generation and measurement, the performance of individual units comprising the system should be checked periodically. Refer to the Instruction Manual for each unit for complete calibration and verification procedures.

Repackaging for Shipment

If the Tektronix instrument is to be shipped to a Tektronix Service Center for service or repair, attach a tag showing: owner (with address) and the name of an individual at your firm that can be contacted, complete instrument serial number and a description of the service required.

Save and re-use the package in which your instrument was shipped. If the original packaging is unfit for use or not available, repackage the instrument as follows:

Surround the instrument with polyethylene sheeting to protect the finish of the instrument. Obtain a carton of corrugated cardboard of the correct carton strength and having inside dimensions of no less than six inches more than the instrument dimensions. Cushion the instrument by tightly packing three inches of dunnage or urethane foam between carton and instrument, on all sides. Seal carton with shipping tape or industrial stapler

The carton test strength for your instrument is 200 pounds.

TROUBLESHOOTING AIDS

Introduction

The following is provided to augment information contained elsewhere in this and other TM 500 Series family manuals when troubleshooting becomes necessary.

Circuit Descriptions

Each manual has a section devoted to explaining circuit operating theory. Used conjointly with the schematics, this can be a powerful analytic tool.

Diagrams

Block diagrams and detailed circuit schematics are located on foldout pages in the service section of most of the TM 500 Series family manuals. The schematic diagrams show the component values and assigned circuit reference numbers of each part necessary to the circuit design. Usually the first page of the service sections defines the circuit symbols and reference designators used in that particular instrument. Major circuits are usually identifiable by a series of component numbers. Important waveforms and voltages may be shown within the diagrams or on adjoining aprons. Those portions of the circuits located on circuit boards are enclosed with a blue tint outline.

Cam Switch Charts

Cam switches shown on the diagrams are coded in comprehensive charts to locate the cam number of the switch contact in the complete switch assembly, counting from the front, or knob end, toward the rear of the switch. The charts also indicate with a solid dot when each contact is closed.

Circuit Board Illustrations

Line illustrations showing component locations keyed with a grid scheme for each circuit board are usually placed on the back of a foldout page and sequenced as close as possible to an associated schematic. The GRID LOC column in the Electrical Parts Lists keys each component to the Location illustrations.

Component and Wiring Color Codes

Colored stripes or dots on electrical components signify electrical values, tolerances, etc., according to EIA standards. Components not color-coded usually have information printed on the body. The wiring coding follows the same EIA standards with the exception of the AC power cord of the Power Modules. It is coded like this:

Black	Line
White	Neutral
Green with a Yellow stripe	Safety Earth or Ground

Testing Equipment

Generally, a wide-band oscilloscope, a probe, and a multimeter are all that is needed to perform basic waveform and voltage checks for diagnostic purposes. The calibration procedures in the manual for each plug-in module list specific test equipment and the features necessary to adequately check out that particular module.

TROUBLESHOOTING TECHNIQUES

Introduction

This troubleshooting procedure is arranged in an order which checks the simple trouble possibilities before proceeding to extensive troubleshooting.

Control Settings

Incorrect control settings can indicate a trouble that does not exist. If there is any question about the correct function or operation of any control, see the Operating Instructions section of the manual for the instrument involved.

System and Associated Equipment

Before proceeding with troubleshooting the TM 500 Series system, check that the instruments in the system are operating correctly. Check for proper interconnection between the power module and the plug-in module. Check the line voltage at the power source. Check that the signal is properly connected and that the interconnecting cables and the signal source are not defective.

The associated plug-in modules can be checked for proper operation quickly by substituting other like units known to be operating properly. If the trouble persists after substitution, then the power module is probably at fault.

Visual Check

Inspect the portion of the system in which the trouble is suspected. Many troubles can be located by visual clues such as unsoldered connections, broken wires, damaged circuit boards, damaged components, etc.

Instrument Calibration

Check the calibration of the suspected plug-in module or the affected circuit if the trouble is obviously in a certain circuit. The trouble may only be a result of misadjustment or may be corrected by re-calibration. Complete calibration instructions are given in the manual for each instrument in the system.

Circuit Isolation

Note the symptom. It often identifies the circuit in which the trouble is located. When trouble symptoms appear in more than one circuit, check the affected circuits by making waveform and voltage measurements.

Incorrect operation of all circuits often means trouble in the power supplies. Using a multimeter, check first for correct voltages of the individual regulated supplies according to the plug-in module schematics and calibration procedures. Then check the unregulated supplies of the power module. Defective components elsewhere in the instruments can appear as power supply problems. In these instances, suspected circuits should be disconnected from apparently bad power supplies one at a time to narrow the search.

Voltages and Waveforms

Often defective components can be located by using waveform and voltage indications when they appear on the schematic or in the calibration procedures. Such waveforms and voltage labels are typical indications and will vary between instruments. To obtain operating conditions similar to those used to take these readings, refer to the first diagram in the service sections.

Component Checking

If a component cannot be disconnected from its circuit, then the effects of the associated circuitry must be considered when evaluating the measurement. Each for soldered-in transistors and integrated circuits most components can be lifted at one end from the circuit board.

Transistors and IC's. Turn the power switch off before removing or replacing any semiconductor.

A good check of transistor operation is actual performance under operating conditions. A transistor can most effectively be checked by substituting a new component for it (or one which has been checked previously). However, be sure that circuit conditions are not such that a replacement transistor might also be damaged. If substitute transistors are not available, use a dynamic tester. Static-type testers are not recommended, since they do not check operation under simulated operating conditions. A suction-type desoldering tool must be used to remove soldered-in transistors; see component replacement procedure for details.

Integrated circuits can be checked with a voltmeter, test oscilloscope, or by direct substitution. A good understanding of the circuit description is essential to troubleshooting circuits using IC's. Operating waveforms, logic levels, and other operating information for the IC's are given in the circuit description information of the appropriate manual. Use care when checking voltages and waveforms around the IC's so that adjacent leads are not shorted together. A convenient means of clipping a test probe to the 14- and 16-pin in-line IC's is with an integrated-circuit test clip. This device also doubles as an extraction tool.

Diodes. Do not use an ohmmeter that has a high internal current. High currents may damage the diode.

A diode may be checked for an open or shorted condition by measuring the resistance between terminals. With an ohmmeter scale having an internal source of between 800 mV and 3 V, the resistance should be very high in one direction and very low when the leads are reversed.

Resistors. Check the resistors with an ohmmeter. Resistor tolerances are given in the Electrical Parts List in every manual. Resistors do not normally need to be replaced unless the measured value varies widely from the specified value.

Capacitors. A leaky or shorted capacitor can be detected by checking resistance with an ohmmeter on the highest scale. Use an ohmmeter which will not exceed the voltage rating of the capacitor. The resistance reading should be high after initial charge of the capacitor. An open capacitor can best be detected with a capacity meter, or by checking whether it passes AC signals.

PARTS ORDERING AND REPLACING

Ordering

Standard Parts. All electrical and mechanical replacement parts can be obtained through the local TEKTRONIX Field Office or representative. However, many of the standard electronic components can be obtained locally in less time than is required to order them from Tektronix, Inc. Before purchasing or ordering replacement parts, check the Parts Lists for value, tolerance, rating, and description. When selecting replacement parts, it is important to remember that the physical size and shape of the component may affect its performance in an instrument. All replacement parts should be direct replacements unless it is known that a different component will not adversely affect the instrument performance.

Special Parts. Some parts are manufactured or selected by Tektronix, Inc., to satisfy particular requirements, or are manufactured for Tektronix, Inc., to our specifications. Most of the mechanical parts used in this system have been manufactured by Tektronix, Inc. Order all special parts directly from the local TEKTRONIX Field Office or representative.

Ordering Procedure. When ordering replacement parts from Tektronix, Inc., please include the following minimum information:

1. Instrument Type (PS 501, SG 502, DC 501, etc.)
2. Instrument Serial Number (For example, B010250)
3. A description of the part (if electrical, include the circuit number)
4. TEKTRONIX part number

Please do not return any instruments or parts before receiving directions from Tektronix, Inc.

A listing of TEKTRONIX Field Offices, Service Centers, and Representatives can be found in the TEKTRONIX Product Catalog and Supplements.

Replacing

The exploded view drawings associated with the Mechanical Parts Lists, located to the rear of most manuals,

may be especially helpful when disassembling or re-assembling individual components or sub-assemblies.

Circuit Boards. If a circuit board is damaged beyond repair the entire assembly including all soldered-on components, can be replaced. Part numbers are given in the mechanical parts list for the completely wired (670 prefix) board (388 prefix).

To remove or replace a board, proceed as follows:

1. Disconnect all leads connected to the board (both soldered lead connections and solderless pin connections).
2. Remove all screws holding the board to the chassis or other mounting surface. Some boards may be held fast by plastic mounting clips around the board edges. For these, push the mounting clips away from the circuit board edges to free the board. Also, remove any knobs, etc., that would prevent the board from being lifted out of the instrument.
3. Lift the circuit board out of the unit. Do not force or bend the board.
4. To replace the board, reverse the order of removal. Use care when replacing pin connectors; if forced into place incorrectly positioned, the pin connectors may be damaged.

Transistors and IC's. Transistors and IC's should not be replaced unless they are actually defective. If removed from their sockets during routine maintenance return them to their original sockets. Unnecessary replacement or switching of semiconductor devices may affect the calibration of the instruments. When a transistor is replaced, check the operation of the part of the instrument that may be affected.

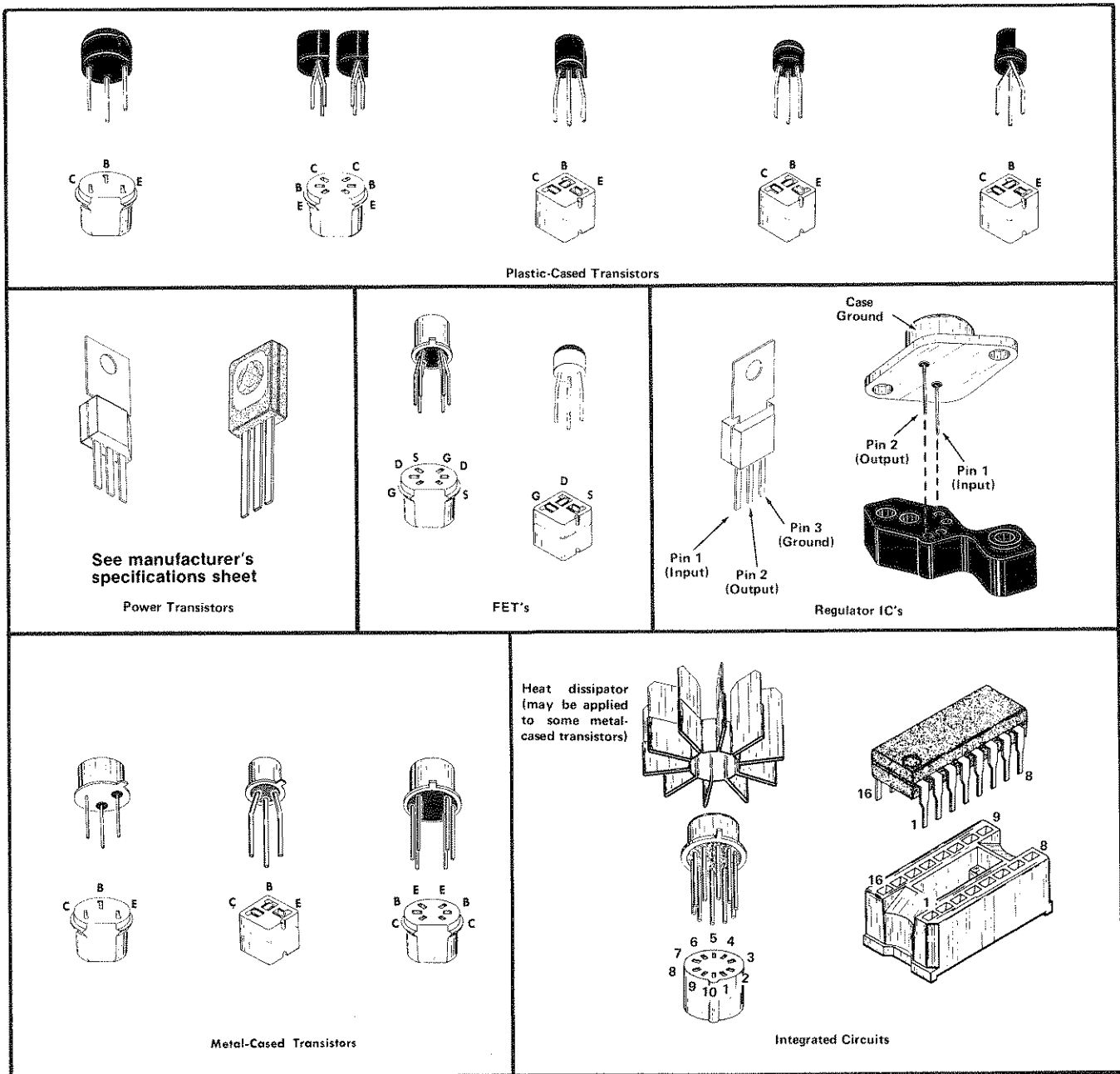

Figure 2. Semiconductor device lead configurations found in the TM 500 family.

Replacement semiconductors should be of the original type or a direct replacement. Figure 2 shows the lead configuration of the semiconductors used in this instrument system. When removing soldered-in transistors, use a suction-type de-soldering tool to remove the solder from the holes in the circuit board.

An extracting tool should be used to remove the 14- and 16-pin integrated circuits to prevent damage to the pins. This tool is available from Tektronix, Inc. Order TEKTRONIX Part No. 003-0619-00. If an extracting tool is

not available, use care to avoid damaging the pins. Pull slowly and evenly on both ends of the IC. Try to avoid having one end of the IC disengage from the socket before the other end.

To replace one of the power transistors mounted on the Power Module chassis adjacent to the interface circuit board, first unsolder the leads. Then, loosen the nuts which clamp the transistor to the chassis. Remove the defective transistor. When replacing the transistor, use a mica washer on the metal tab to increase heat transfer from the transistor to the chassis.

Interconnecting Pins. To replace a pin which is mounted on a circuit board, first disconnect any pin connectors. Then, unsolder the damaged pin and pull it out of the board with a pair of pliers. Be careful not to damage the wiring on the board with too much heat. Ream out the hole in the circuit board with a 0.031-inch drill. Remove the ferrule from the new interconnecting pin and press the new pin into the hole in the circuit board. Position the pin in the same manner as the old pin. If the old pin was bent at an angle to mate with a connector, bend the new pin to match the associated pins.

NOTE

A pin replacement kit including necessary tools, instructions, and replacement pins is available from Tektronix, Inc. Order TEKTRONIX Part No. 040-0542-00.

Cam Switches. Repair of cam-type switches should be undertaken only by experienced maintenance personnel. Switch alignment and spring tension of the contacts must be carefully maintained for proper operation of the switch. For assistance, contact your local TEKTRONIX Field Office or representative.

NOTE

A cam-type switch repair kit including necessary tools, instructions, and replacement contacts is available from Tektronix, Inc. Order TEKTRONIX Part No. 040-0541-00.

The cam-type switches consist of rotating cam drums which are turned by front-panel knobs, and sets of spring-leaf contacts mounted on adjacent circuit boards. The contacts are actuated by lobes on the cams. These switches can be disassembled for inspection, cleaning, repair, or replacement as follows:

1. Remove the screws which hold the metal cover on the switch, and lift the cover off the switch. The switch is now open for inspection or cleaning.

2. To completely remove a switch from the circuit board, first remove any knobs or shaft extensions. Loosen the coupling at the potentiometer at the rear of the switch, and pull the long shaft out of the switch assembly.

3. Remove the screws (from the opposite side of the circuit board) which hold the cam drum to the board.

4. To remove the cam drum from the front support block, remove the retaining ring from the shaft on the front of the switch and slide the cam drum out of the support block. Be careful not to lose the small detent roller.

5. To replace defective switch contacts, follow the instructions given in the switch repair kit.

6. To re-install the switch assembly, reverse the above procedure.

Pushbutton Switches. The pushbutton switches are not repairable and should be replaced as a unit if defective. Use a suction-type de-soldering tool to remove solder from the circuit board when removing these switches.

Incandescent Bulbs. Most of these light bulbs are mounted on the sub-panel using plastic sleeve stand-offs. Unsolder the lead wires and pull the bulb out of the sleeve from the rear of the sub-panel.

Light-Emitting Diodes. LED's used as indicators are mounted on the sub-panels with plastic sleeve sockets similar to the incandescent bulb mountings or they are soldered directly to a sub-assembly and so mounted that they protrude through holes in the panel. In these cases, the sub-assembly must be exposed and the anode and cathode lead orientations carefully noted before unsoldering the defective LED. See Figure 3 for LED lead identifying information.

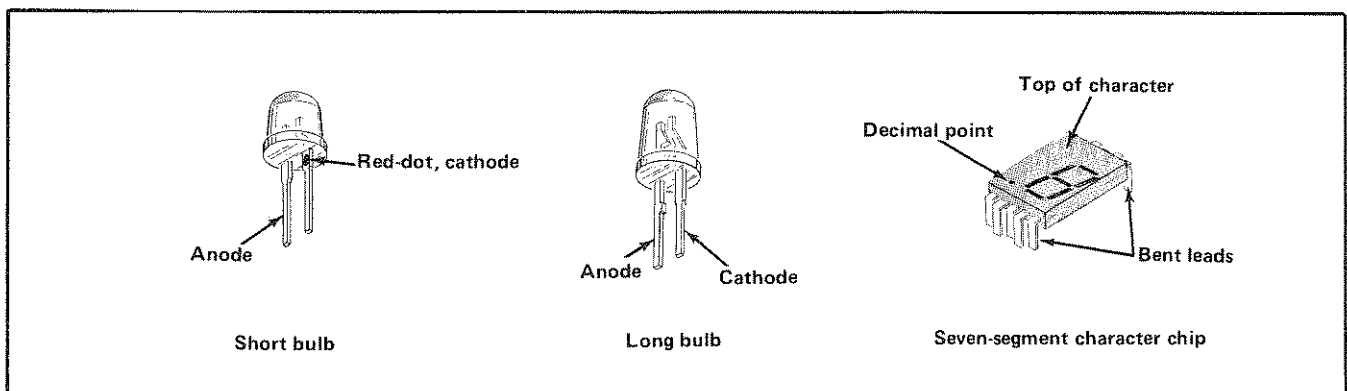

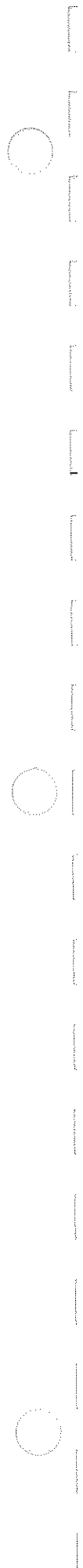

Figure 3. Light-emitting diode (LED) lead orientation illustration.

 **Power Transformer.** Replace the transformer only with a TEKTRONIX direct replacement transformer. Refer to the exploded view drawing at the rear of the Power Module manuals for disassembly of the rear panel to expose the

power transformer. Refer to the schematic diagram color-coding information for correct wiring. After replacement, check out the power supply voltages before installing a plug-in module.



DIAGRAMS AND CIRCUIT BOARD ILLUSTRATIONS

Symbols and Reference Designators

Electrical components shown on the diagrams are in the following units unless noted otherwise:

- Capacitors = Values one or greater are in picofarads (pF).
Values less than one are in microfarads (μF).
- Resistors = Ohms (Ω).

Graphic symbols and class designation letters are based on ANSI Standard Y32.2-1975.

Logic symbology is based on ANSI Y32.14-1973 in terms of positive logic. Logic symbols depict the logic function performed and may differ from the manufacturer's data.

The overline on a signal name indicates that the signal performs its intended function when it goes to the low state.

Abbreviations are based on ANSI Y1.1-1972.

Other ANSI standards that are used in the preparation of diagrams by Tektronix, Inc. are:

- Y14.15, 1966 Drafting Practices.
- Y14.2, 1973 Line Conventions and Lettering.
- Y10.5, 1968 Letter Symbols for Quantities Used in Electrical Science and Electrical Engineering.

The following prefix letters are used as reference designators to identify components or assemblies on the diagrams.

A	Assembly, separable or repairable (circuit board, etc)	H	Heat dissipating device (heat sink, heat radiator, etc)	S	Switch or contactor
AT	Attenuator, fixed or variable	HR	Heater	T	Transformer
B	Motor	HY	Hybrid circuit	TC	Thermocouple
BT	Battery	J	Connector, stationary portion	TP	Test point
C	Capacitor, fixed or variable	K	Relay	U	Assembly, inseparable or non-repairable (integrated circuit, etc.)
CB	Circuit breaker	L	Inductor, fixed or variable	V	Electron tube
CR	Diode, signal or rectifier	M	Meter	VR	Voltage regulator (zener diode, etc.)
DL	Delay line	P	Connector, movable portion	W	Wirestrap or cable
DS	Indicating device (lamp)	Q	Transistor or silicon-controlled rectifier	Y	Crystal
E	Spark Gap, Ferrite bead	R	Resistor, fixed or variable	Z	Phase shifter
F	Fuse	RT	Thermistor		
FL	Filter				

The following special symbols may appear on the diagrams:

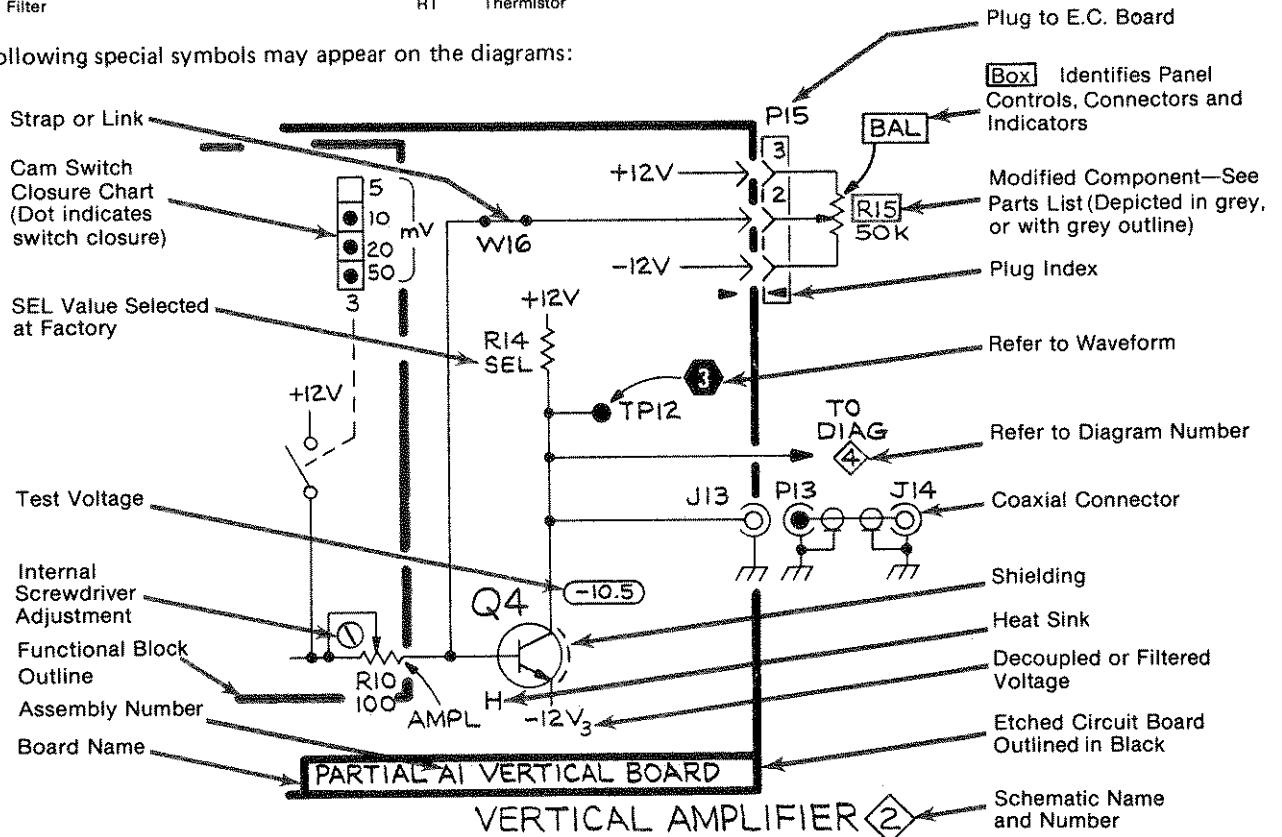



POWER MODULE INTERFACE PIN ASSIGNMENTS

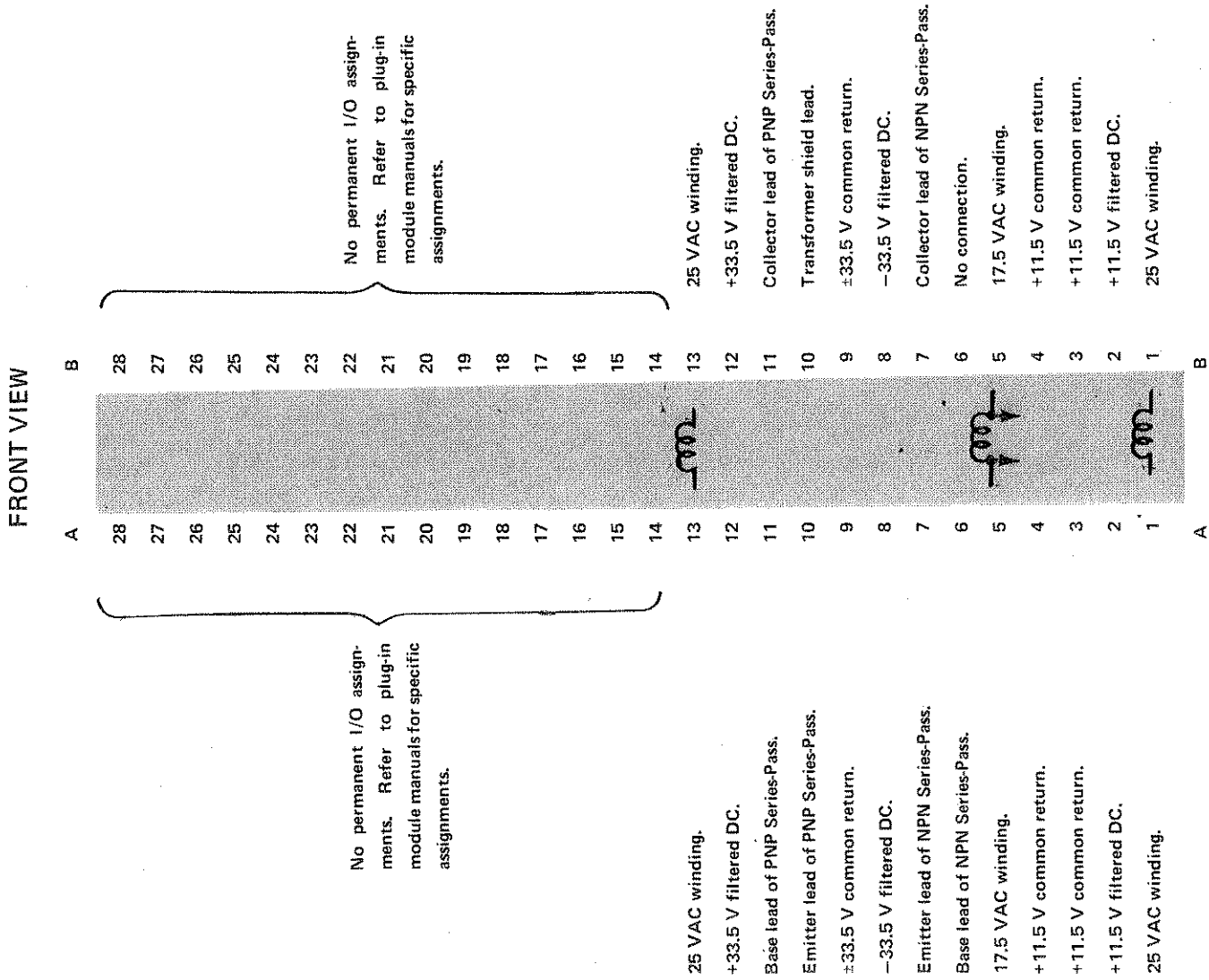

DETAILED BLOCK DIAGRAM

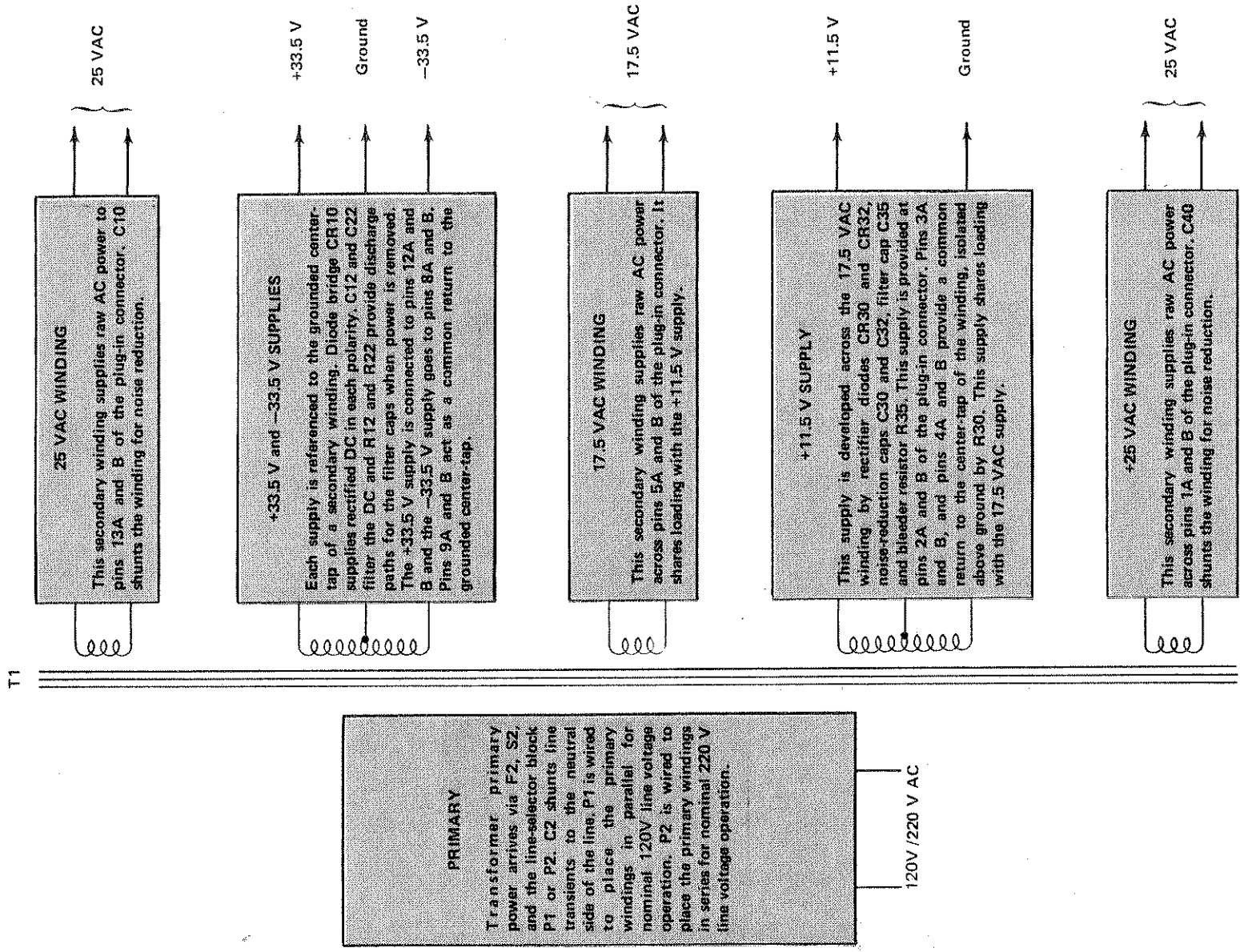

PARTS LOCATION GRID

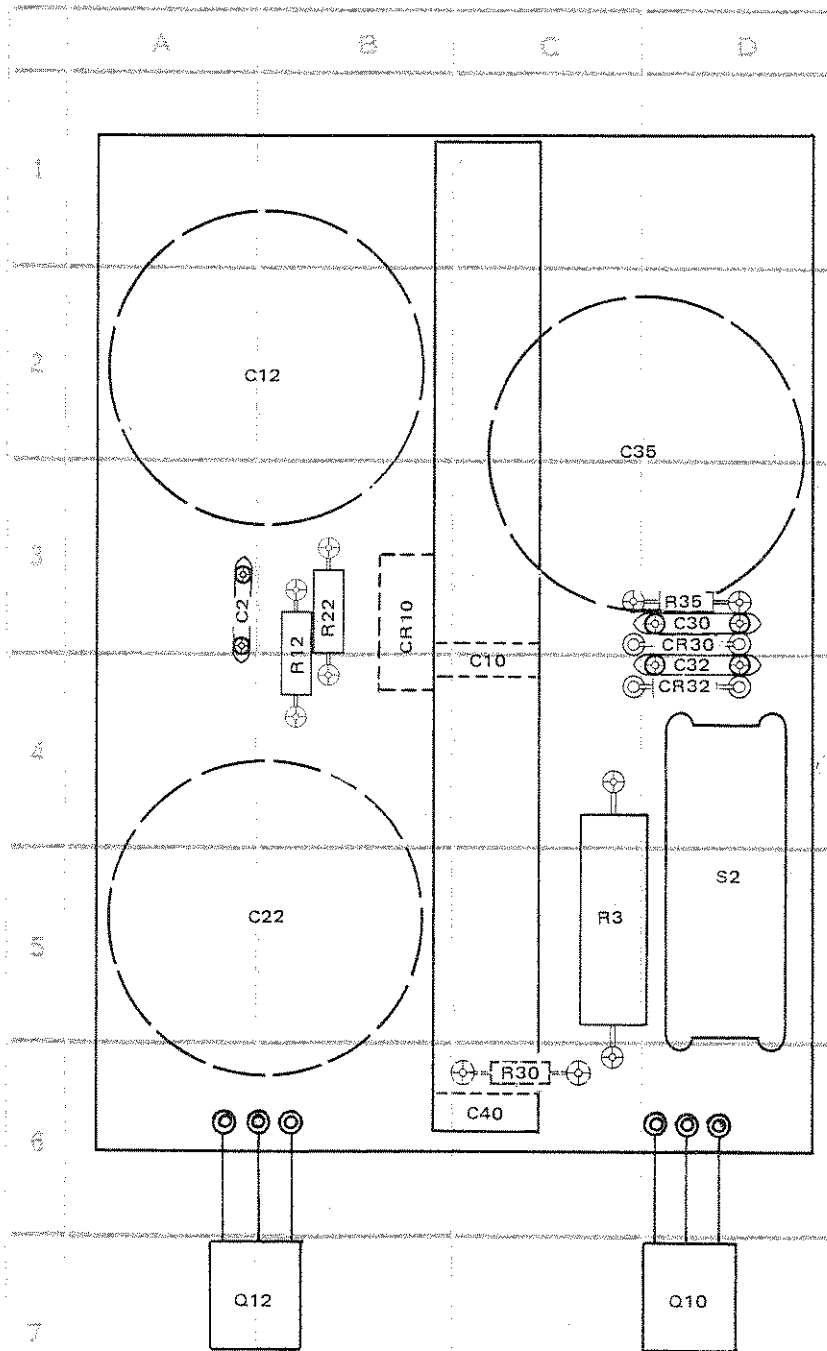

NOTE: COMPONENTS SHOWN WITH DASHED LINES ARE LOCATED ON BACK SIDE OF BOARD.

REV C, APR 1979

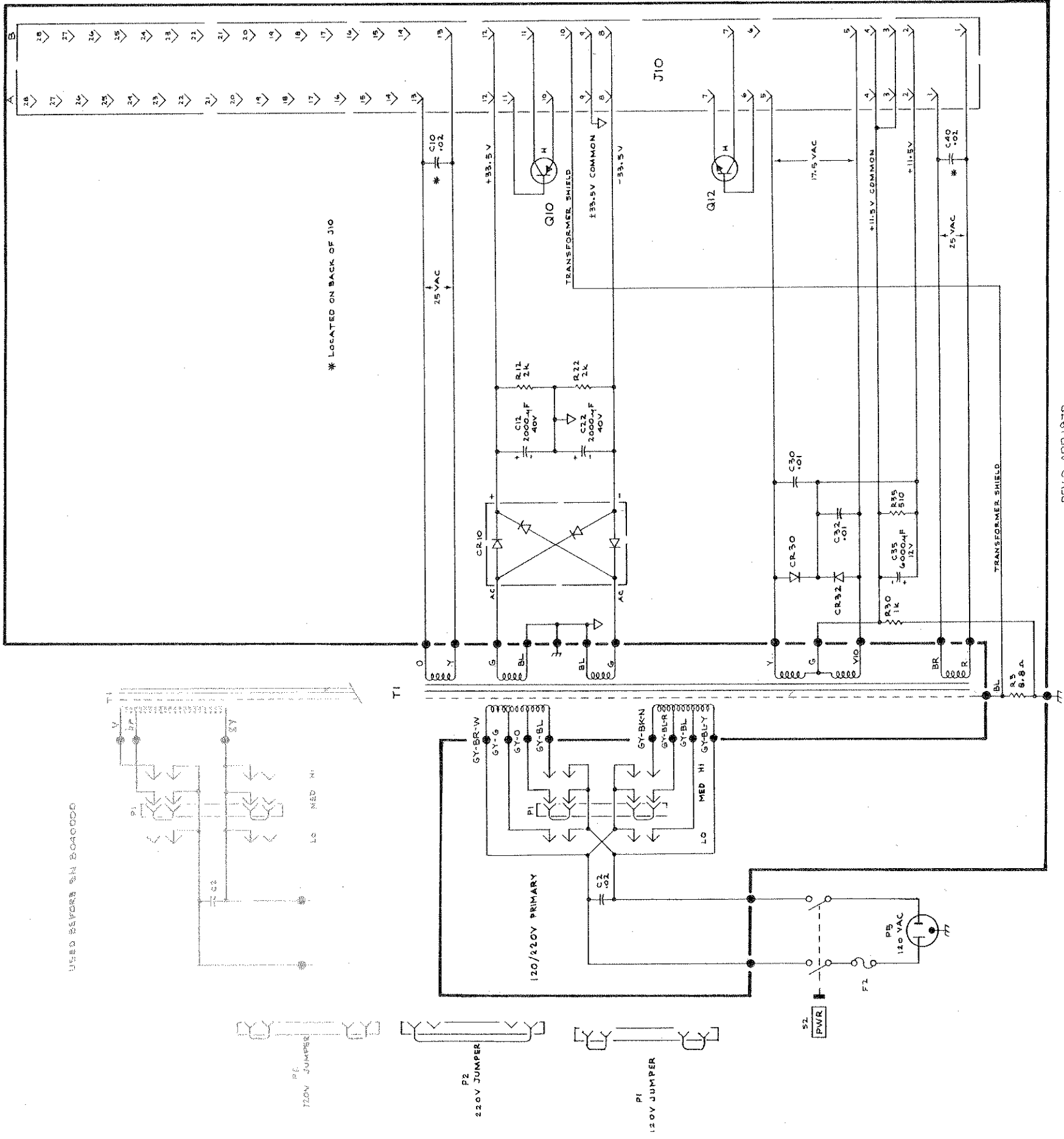

REPLACEABLE ELECTRICAL PARTS

PARTS ORDERING INFORMATION

Replacement parts are available from or through your local Tektronix, Inc. Field Office or representative.

Changes to Tektronix instruments are sometimes made to accommodate improved components as they become available, and to give you the benefit of the latest circuit improvements developed in our engineering department. It is therefore important, when ordering parts, to include the following information in your order: Part number, instrument type or number, serial number, and modification number if applicable.

If a part you have ordered has been replaced with a new or improved part, your local Tektronix, Inc. Field Office or representative will contact you concerning any change in part number.

Change information, if any, is located at the rear of this manual.

SPECIAL NOTES AND SYMBOLS

- X000 Part first added at this serial number
- 00X Part removed after this serial number

ITEM NAME

In the Parts List, an Item Name is separated from the description by a colon (:). Because of space limitations, an Item Name may sometimes appear as incomplete. For further Item Name identification, the U.S. Federal Cataloging Handbook H6-1 can be utilized where possible.

ABBREVIATIONS

ACTR	ACTUATOR	PLSTC	PLASTIC
ASSY	ASSEMBLY	QTZ	QUARTZ
CAP	CAPACITOR	RECP	RECEPTACLE
CER	CERAMIC	RES	RESISTOR
CKT	CIRCUIT	RF	RADIO FREQUENCY
COMP	COMPOSITION	SEL	SELECTED
CONN	CONNECTOR	SEMICOND	SEMICONDUCTOR
ELCTLT	ELECTROLYTIC	SENS	SENSITIVE
ELEC	ELECTRICAL	VAR	VARIABLE
INCAND	INCANDESCENT	WW	WIREWOUND
LED	LIGHT EMITTING DIODE	XFMR	TRANSFORMER
NONWIR	NON WIREWOUND	XTAL	CRYSTAL

CROSS INDEX—MFR. CODE NUMBER TO MANUFACTURER

Mfr. Code	Manufacturer	Address	City, State, Zip
01121	ALLEN-BRADLEY COMPANY	1201 2ND STREET SOUTH	MILWAUKEE, WI 53204
03508	GENERAL ELECTRIC COMPANY, SEMI-CONDUCTOR PRODUCTS DEPARTMENT	ELECTRONICS PARK	SYRACUSE, NY 13201
04713	MOTOROLA, INC., SEMICONDUCTOR PROD. DIV.	5005 E MCDOWELL RD, PO BOX 20923	PHOENIX, AZ 85036
14099	SEMTECH CORP.	652 MITCHELL RD.	NEWBURY PARK, CA 91320
56289	SPRAGUE ELECTRIC CO.		NORTH ADAMS, MA 01247
71400	BUSSMAN MFG., DIVISION OF MCGRAW-EDISON CO.	2536 W. UNIVERSITY ST.	ST. LOUIS, MO 63107
72982	ERIE TECHNOLOGICAL PRODUCTS, INC.	644 W. 12TH ST.	ERIE, PA 16512
80009	TEKTRONIX, INC.	P O BOX 500	BEAVERTON, OR 97077
91637	DALE ELECTRONICS, INC.	P. O. BOX 609	COLUMBUS, NE 68601
91929	HONEYWELL, INC., MICRO SWITCH DIV.	CHICAGO & SPRING STS.	FREEPORT, IL 61032
95238	CONTINENTAL CONNECTOR CORP.	34-63 56TH ST.	WOODSIDE, NY 11377

Ckt No.	Tektronix Part No.	Serial/Model No. Eff	Dscont	Name & Description	Mfr Code	Mfr Part Number
A1	670-2023-00			CKT BOARD ASSY: INTERFACE	80009	670-2023-00
A1	670-3404-00			CKT BOARD ASSY: INTERFACE (OPTION 2 ONLY)	80009	670-3404-00
C2	283-0022-00			CAP., FXD, CER DI: 0.02UF, 1400VDCAC	80009	283-0022-00
C10	283-0004-00			CAP., FXD, CER DI: 0.02UF, +80-20%, 150V	72982	855-558Z5V0203Z
C12	290-0577-00			CAP., FXD, ELCTLT: 2000UF, 50V	56289	68D10504
C22	290-0577-00			CAP., FXD, ELCTLT: 2000UF, 50V	56289	68D10504
C30	283-0002-00			CAP., FXD, CER DI: 0.01UF, +80-20%, 500V	72982	811-546E103Z
C32	283-0002-00			CAP., FXD, CER DI: 0.01UF, +80-20%, 500V	72982	811-546E103Z
C35	290-0578-00			CAP., FXD, ELCTLT: 6000UF, 12V	56289	68D10429
C40	283-0004-00			CAP., FXD, CER DI: 0.02UF, +80-20%, 150V	72982	855-558Z5V0203Z
CR10	152-0488-00			SEMICONV DEVICE: SILICON, 200V, 1500MA	04713	3N55 FAMILY
CR30	152-0198-00	B010100	B039999	SEMICONV DEVICE: SILICON, 200V, 3A	03508	1N5624
CR30	152-0198-02	B040000		SEMICONV DEVICE: SILICON, 200V, 3A	14099	3SM2
CR32	152-0198-00	B010100	B039999	SEMICONV DEVICE: SILICON, 200V, 3A	03508	1N5624
CR32	152-0198-02	B040000		SEMICONV DEVICE: SILICON, 200V, 3A	14099	3SM2
F2	159-0043-00			FUSE, CARTRIDGE: 3AG, 0.6A, 250V, SLOW-BLOW (FOR 120 VOLT OPERATION)	71400	MDL 6/10
F2	159-0029-00			FUSE, CARTRIDGE: 3AG, 0.3A, 250V, SLOW-BLOW (FOR 220 VOLT OPERATION)	71400	MDL3/10
J10	131-1078-00			CONNECTOR, RCPT, :28/56 CONTACT	95238	600-1156Y256DF30
Q10	151-0373-00			TRANSISTOR: SILICON, PNP	80009	151-0373-00
Q12	151-0349-00			TRANSISTOR: SILICON, NPN, SEL FROM MJE2801	04713	SJE924
R3	308-0704-00			RES., FXD, WW: 8.8 OHM, 5%, 5W	91637	CW5-8R800J
R12	301-0202-00			RES., FXD, CMPSN: 2K OHM, 5%, 0.50W	01121	EB2025
R22	301-0202-00			RES., FXD, CMPSN: 2K OHM, 5%, 0.50W	01121	EB2025
R30	302-0102-00			RES., FXD, CMPSN: 1K OHM, 10%, 0.50W	01121	EB1021
R35	315-0511-00			RES., FXD, CMPSN: 510 OHM, 5%, 0.25W	01121	CB5115
S2	260-1222-00			SWITCH, PUSH-PUL: 10A, 250VAC	91929	2DM301
T1	120-0790-00	B010100	B039999	XFMR, PWR, STPDN: 60HZ	80009	120-0790-00
T1	120-0791-00	B040000	B069999	XFMR, PWR, STPDN: 50-400HZ	80009	120-0791-00
T1	120-0791-01	B070000		XFMR, PWR, STPDN: 50-400HZ	80009	120-0791-01

1
2
3
4
5
6
7
8
9
10
11
12
13
14
15
16
17
18
19
20
21
22
23
24
25
26
27
28
29
30
31
32
33
34
35
36
37
38
39
40
41
42
43
44
45
46
47
48
49
50
51
52
53
54
55
56
57
58
59
60
61
62
63
64
65
66
67
68
69
70
71
72
73
74
75
76
77
78
79
80
81
82
83
84
85
86
87
88
89
90
91
92
93
94
95
96
97
98
99
100

REPLACEABLE MECHANICAL PARTS

PARTS ORDERING INFORMATION

Replacement parts are available from or through your local Tektronix, Inc. Field Office or representative.

Changes to Tektronix instruments are sometimes made to accommodate improved components as they become available, and to give you the benefit of the latest circuit improvements developed in our engineering department. It is therefore important, when ordering parts, to include the following information in your order: Part number, instrument type or number, serial number, and modification number if applicable.

If a part you have ordered has been replaced with a new or improved part, your local Tektronix, Inc. Field Office or representative will contact you concerning any change in part number.

Change information, if any, is located at the rear of this manual.

SPECIAL NOTES AND SYMBOLS

- X000 Part first added at this serial number
- 00X Part removed after this serial number

FIGURE AND INDEX NUMBERS

Items in this section are referenced by figure and index numbers to the illustrations.

INDENTATION SYSTEM

This mechanical parts list is indented to indicate item relationships. Following is an example of the indentation system used in the description column.

- ```

1 2 3 4 5 Name & Description
Assembly and/or Component
Attaching parts for Assembly and/or Component
 - - - * - - -
Detail Part of Assembly and/or Component
Attaching parts for Detail Part
 - - - * - - -
Parts of Detail Part
Attaching parts for Parts of Detail Part
 - - - * - - -

```

Attaching Parts always appear in the same indentation as the item it mounts, while the detail parts are indented to the right. Indented items are part of, and included with, the next higher indentation. The separation symbol - - - \* - - - indicates the end of attaching parts.

**Attaching parts must be purchased separately, unless otherwise specified.**

## ITEM NAME

In the Parts List, an Item Name is separated from the description by a colon (:). Because of space limitations, an Item Name may sometimes appear as incomplete. For further Item Name identification, the U.S. Federal Cataloging Handbook H6-1 can be utilized where possible.

## ABBREVIATIONS

|       |                    |         |                       |          |                      |          |                 |
|-------|--------------------|---------|-----------------------|----------|----------------------|----------|-----------------|
| "     | INCH               | ELCTRN  | ELECTRON              | IN       | INCH                 | SE       | SINGLE END      |
| #     | NUMBER SIZE        | ELEC    | ELECTRICAL            | INCAND   | INCANDESCENT         | SECT     | SECTION         |
| ACTR  | ACTUATOR           | ELCTLT  | ELECTROLYTIC          | INSUL    | INSULATOR            | SEMICONO | SEMICONDUCTOR   |
| ADPTR | ADAPTER            | ELEM    | ELEMENT               | INTL     | INTERNAL             | SHLD     | SHIELD          |
| ALIGN | ALIGNMENT          | EPL     | ELECTRICAL PARTS LIST | LPHLDR   | LAMPHOLDER           | SHLDR    | SHOULDERED      |
| AL    | ALUMINUM           | EQPT    | EQUIPMENT             | MACH     | MACHINE              | SKT      | SOCKET          |
| ASSEM | ASSEMBLED          | EXT     | EXTERNAL              | MECH     | MECHANICAL           | SL       | SLIDE           |
| ASSY  | ASSEMBLY           | FIL     | FILLISTER HEAD        | MTG      | MOUNTING             | SLFLKG   | SELF-LOCKING    |
| ATTEN | ATTENUATOR         | FLEX    | FLEXIBLE              | NIP      | NIPPLE               | SLVG     | SLEEVING        |
| AWG   | AMERICAN WIRE GAGE | FLH     | FLAT HEAD             | NON WIRE | NOT WIRE WOUND       | SPR      | SPRING          |
| BD    | BOARD              | FLTR    | FILTER                | OBD      | ORDER BY DESCRIPTION | SQ       | SQUARE          |
| BRKT  | BRACKET            | FR      | FRAME or FRONT        | OD       | OUTSIDE DIAMETER     | SST      | STAINLESS STEEL |
| BRS   | BRASS              | FSTNR   | FASTENER              | OVH      | OVAL HEAD            | STL      | STEEL           |
| BRZ   | BRONZE             | FT      | FOOT                  | PH BRZ   | PHOSPHOR BRONZE      | SW       | SWITCH          |
| BSHG  | BUSHING            | FXD     | FIXED                 | PL       | PLAIN or PLATE       | T        | TUBE            |
| CAB   | CABINET            | GSKT    | GASKET                | PLSTC    | PLASTIC              | TERM     | TERMINAL        |
| CAP   | CAPACITOR          | HDL     | HANDLE                | PN       | PART NUMBER          | THD      | THREAD          |
| CER   | CERAMIC            | HEX     | HEXAGON               | PNH      | PAN HEAD             | THK      | THICK           |
| CHAS  | CHASSIS            | HEX HD  | HEXAGONAL HEAD        | PWR      | POWER                | TNSN     | TENSION         |
| CKT   | CIRCUIT            | HEX SOC | HEXAGONAL SOCKET      | RCPT     | RECEPTACLE           | TPG      | TAPPING         |
| COMP  | COMPOSITION        | HLCPS   | HELICAL COMPRESSION   | RES      | RESISTOR             | TRH      | TRUSS HEAD      |
| CONN  | CONNECTOR          | HLEXT   | HELICAL EXTENSION     | RGD      | RIGID                | V        | VOLTAGE         |
| COV   | COVER              | HV      | HIGH VOLTAGE          | RLF      | RELIEF               | VAR      | VARIABLE        |
| CPLG  | COUPLING           | IC      | INTEGRATED CIRCUIT    | RTNR     | RETAINER             | W/       | WITH            |
| CRT   | CATHODE RAY TUBE   | ID      | INSIDE DIAMETER       | SCH      | SOCKET HEAD          | WSHR     | WASHER          |
| DEG   | DEGREE             | IDENT   | IDENTIFICATION        | SCOPE    | OSCILLOSCOPE         | XFMR     | TRANSFORMER     |
| DWR   | DRAWER             | IMPLR   | IMPELLER              | SCR      | SCREW                | XSTR     | TRANSISTOR      |

CROSS INDEX—MFR. CODE NUMBER TO MANUFACTURER

| Mfr. Code | Manufacturer                                                | Address                          | City, State, Zip           |
|-----------|-------------------------------------------------------------|----------------------------------|----------------------------|
| 000AH     | STANDARD PRESSED STEEL CO., UNBRAKO DIV.                    | 8535 DICE ROAD                   | SANTA FE SPRINGS, CA 90670 |
| 00779     | AMP, INC.                                                   | P O BOX 3608                     | HARRISBURG, PA 17105       |
| 04713     | MOTOROLA, INC., SEMICONDUCTOR PROD. DIV.                    | 5005 E MCDOWELL RD, PO BOX 20923 | PHOENIX, AZ 85036          |
| 07707     | USM CORP., USM FASTENER DIV.                                | 510 RIVER RD.                    | SHELTON, CT 06484          |
| 12136     | PHILADELPHIA HANDLE COMPANY, INC.                           | 1643 HADDON AVENUE               | CAMDEN, NJ 08103           |
| 12360     | ALBANY PRODUCTS CO., DIV. OF PNEUMO<br>DYNAMICS CORPORATION | 145 WOODWARD AVENUE              | SOUTH NORWALK, CT 06586    |
| 16428     | BELDEN CORP.                                                | P. O. BOX 1331                   | RICHMOND, IN 47374         |
| 18680     | HIGHLAND MFG. CO., THE DIV. OF BUELL<br>INDUSTRIES, INC.    | 1240 WOLCOTT STREET              | WATERBURY, CT 06720        |
| 22526     | BERG ELECTRONICS, INC.                                      | YOUK EXPRESSWAY                  | NEW CUMBERLAND, PA 17070   |
| 28520     | HEYMAN MFG. CO.                                             | 147 N. MICHIGAN AVE.             | KENILWORTH, NJ 07033       |
| 45722     | USM CORP., PARKER-KALON FASTENER DIV.                       |                                  | CAMPBELLSVILLE, KY 42718   |
| 70485     | ATLANTIC INDIA RUBBER WORKS, INC.                           | 571 W. POLK ST.                  | CHICAGO, IL 60607          |
| 73743     | FISCHER SPECIAL MFG. CO.                                    | 446 MORGAN ST.                   | CINCINNATI, OH 45206       |
| 75915     | LITTELFUSE, INC.                                            | 800 E. NORTHWEST HWY             | DES PLAINES, IL 60016      |
| 78189     | ILLINOIS TOOL WORKS, INC.<br>SHAKEPROOF DIVISION            | ST. CHARLES ROAD                 | ELGIN, IL 60120            |
| 78471     | TILLEY MFG. CO.                                             | 900 INDUSTRIAL RD.               | SAN CARLOS, CA 94070       |
| 80009     | TEKTRONIX, INC.                                             | P O BOX 500                      | BEAVERTON, OR 97077        |
| 83385     | CENTRAL SCREW CO.                                           | 2530 CRESCENT DR.                | BROADVIEW, IL 60153        |
| 86445     | PENN FIBRE AND SPECIALTY CO., INC.                          | 2032 E. WESTMORELAND ST.         | PHILADELPHIA, PA 19134     |
| 86928     | SEASTROM MFG. COMPANY, INC.                                 | 701 SONORA AVENUE                | GLENDALE, CA 91201         |
| 91929     | HONEYWELL, INC., MICRO SWITCH DIV.                          | CHICAGO & SPRING STS.            | FREEPORT, IL 61032         |
| 93907     | CAMCAR SCREW AND MFG. CO.                                   | 600 18TH AVE.                    | ROCKFORD, IL 61101         |
| 95238     | CONTINENTAL CONNECTOR CORP.                                 | 34-63 56TH ST.                   | WOODSIDE, NY 11377         |



| Fig. & Index No. | Tektronix Part No. | Serial/Model No. Eff | Dscont   | Qty | 1 | 2 | 3 | 4 | 5 | Name & Description                               | Mfr Code | Mfr Part Number  |
|------------------|--------------------|----------------------|----------|-----|---|---|---|---|---|--------------------------------------------------|----------|------------------|
| 1-1              | 390-0272-00        | B010100              | B059999  | 1   |   |   |   |   |   | CABINET, WRAPAROUND:                             | 80009    | 390-0272-00      |
|                  | 390-0272-01        | B060000              |          | 1   |   |   |   |   |   | CABINET, WRAPAROUND:                             | 80009    | 390-0272-01      |
|                  |                    |                      |          |     |   |   |   |   |   | (ATTACHING PARTS)                                |          |                  |
| -2               | 211-0622-00        |                      |          | 2   |   |   |   |   |   | SCREW, MACHINE: 6-32 X 0.188, TRH, SST, POZ      | 12360    | OBD              |
|                  | -----              |                      |          | -   |   |   |   |   |   | . CABINET ASSY INCLUDES:                         |          |                  |
| -3               | 367-0171-00        |                      |          | 2   |   |   |   |   |   | . HANDLE, CARRYING:                              | 12136    | 845-R-372-140-37 |
| -4               | 210-0586-00        | B010100              | B059999  | 2   |   |   |   |   |   | . NUT, PL, ASSEM WA: 4-40 X 0.25, STL CD PL      | 83385    | 211-041800-00    |
|                  | 210-0783-00        | B060000              |          | 2   |   |   |   |   |   | . RIVET, BLIND: 0.125 OD X 0.357 L, DOMED HEAD   | 07707    | AD 44 ABS        |
| -5               | 210-0958-00        | B010100              | B059999  | 2   |   |   |   |   |   | . WASHER, FLAT: 0.115 ID X 0.469 INCH OD, STL    | 78471    | OBD              |
|                  | 210-0993-00        | B060000              |          | 2   |   |   |   |   |   | . WSHR, SHOULDERED: 0.143" ID X 0.75" OD, BRS    | 86928    | OBD              |
| -6               | 210-0012-00        | B010100              | B059999X | 2   |   |   |   |   |   | . WASHER, LOCK: INTL, 0.375 ID X 0.50" OD STL    | 78189    | 1220-02-00-0541C |
|                  | 390-0272-00        |                      |          | 1   |   |   |   |   |   | . CABINET, WRAPAROUND:                           | 80009    | 390-0272-00      |
| -7               | 384-1158-00        |                      |          | 1   |   |   |   |   |   | SHAFT, EXTENSION: POWER SWITCH                   | 80009    | 384-1158-00      |
| -8               | 376-0127-00        |                      |          | 1   |   |   |   |   |   | COUPLER, SHAFT: PLASTIC                          | 80009    | 376-0127-00      |
| -9               | 260-1222-00        |                      |          | 1   |   |   |   |   |   | SWITCH, PUSH-PUL: 10A, 250VAC                    | 91929    | 2DM301           |
| -10              | 358-0216-00        |                      |          | 1   |   |   |   |   |   | BUSHING, PLASTIC: 0.257 ID X 0.412 INCH OD       | 80009    | 358-0216-00      |
| -11              | 333-1530-00        |                      |          | 1   |   |   |   |   |   | PANEL, FRONT:                                    | 80009    | 333-1530-00      |
|                  |                    |                      |          |     |   |   |   |   |   | (ATTACHING PARTS)                                |          |                  |
| -12              | 211-0022-00        |                      |          | 2   |   |   |   |   |   | SCREW, MACHINE: 2-56 X 0.188 INCH, PNH STL       | 83385    | OBD              |
|                  |                    |                      |          |     |   |   |   |   |   | (ATTACHING PARTS)                                |          |                  |
| -13              | 351-0334-00        | B010100              | B029999  | 1   |   |   |   |   |   | GUIDE, PL-IN UNI:                                | 80009    | 351-0334-00      |
|                  | 351-0379-01        | B030000              |          | 1   |   |   |   |   |   | GUIDE, PL-IN: UPPER                              | 80009    | 351-0379-01      |
|                  |                    |                      |          |     |   |   |   |   |   | (ATTACHING PARTS)                                |          |                  |
| -14              | 213-0254-00        |                      |          | 1   |   |   |   |   |   | SCREW, TPG, TF: 2-32 X 0.250, 100 DEG, FLH       | 45722    | OBD              |
|                  |                    |                      |          |     |   |   |   |   |   | (ATTACHING PARTS)                                |          |                  |
| -15              | 351-0286-00        | B010100              | B019999  | 1   |   |   |   |   |   | GUIDE, PL-IN UNI:                                | 80009    | 351-0286-00      |
|                  | 351-0286-01        | B020000              | B039999  | 1   |   |   |   |   |   | GUIDE, PL-IN UNI:                                | 80009    | 351-0286-01      |
|                  | 351-0286-02        | B040000              | B059999  | 1   |   |   |   |   |   | GUIDE, PL-IN UNI:                                | 80009    | 351-0286-02      |
|                  | 351-0286-04        | B060000              | B082889  | 1   |   |   |   |   |   | GUIDE, PL-IN UNI: LOWER, BLACK NYLON             | 80009    | 351-0286-04      |
|                  | 351-0286-07        | B082890              |          | 1   |   |   |   |   |   | GUIDE, PL-IN UNI: LOWER, NYLON                   | 80009    | 351-0286-07      |
|                  |                    |                      |          |     |   |   |   |   |   | (ATTACHING PARTS)                                |          |                  |
| -16              | 211-0101-00        | B010100              | B082889  | 1   |   |   |   |   |   | SCREW, MACHINE: 4-40 X 0.25" 100 DEG, FLH STL    | 83385    | OBD              |
|                  | 213-0814-00        | B082890              |          | 1   |   |   |   |   |   | SCREW, TPG, TR: 4-20, 0.25 L, PLASTITE           | 93907    | OBD              |
|                  |                    |                      |          |     |   |   |   |   |   | (ATTACHING PARTS)                                |          |                  |
| -17              | 348-0187-00        |                      |          | 4   |   |   |   |   |   | FOOT, CABINET: 0.780 X 1.650 INCH LONG           | 80009    | 348-0187-00      |
|                  |                    |                      |          |     |   |   |   |   |   | (ATTACHING PARTS)                                |          |                  |
| -18              | 211-0551-00        |                      |          | 1   |   |   |   |   |   | SCREW, MACHINE: 6-32 X 0.562 INCH, PNH STL       | 83385    | OBD              |
|                  |                    |                      |          |     |   |   |   |   |   | (ATTACHING PARTS)                                |          |                  |
| -19              | 348-0026-00        |                      |          | 2   |   |   |   |   |   | HINGE BLOCK, STA: LEFT                           | 80009    | 348-0026-00      |
| -20              | 348-0027-00        |                      |          | 2   |   |   |   |   |   | HINGE BLOCK, STA: RIGHT                          | 80009    | 348-0027-00      |
| -21              | 348-0303-00        |                      |          | 1   |   |   |   |   |   | STAND, ELEC EQPT:                                | 80009    | 348-0303-00      |
| -22              | 131-1018-00        | B010100              | B019999  | 1   |   |   |   |   |   | CONTACT, ELEC: PLUG-IN GROUND                    | 80009    | 131-1018-00      |
|                  | 131-1254-01        | B020000              | B075079X | 1   |   |   |   |   |   | CONTACT, ELEC: GROUNDING                         | 80009    | 131-1254-01      |
|                  |                    |                      |          |     |   |   |   |   |   | (ATTACHING PARTS)                                |          |                  |
| -23              | 211-0008-00        | B010100              | B075079X | 1   |   |   |   |   |   | SCREW, MACHINE: 4-40 X 0.25 INCH, PNH STL        | 83385    | OBD              |
|                  | 210-0586-00        | B010100              | B075079X | 1   |   |   |   |   |   | NUT, PL, ASSEM WA: 4-40 X 0.25, STL CD PL        | 83385    | 211-041800-00    |
|                  |                    |                      |          |     |   |   |   |   |   | (ATTACHING PARTS)                                |          |                  |
| -24              | -----              |                      |          | 1   |   |   |   |   |   | CKT BOARD ASSY: INTERFACE (SEE A1 EPL)           |          |                  |
| -25              | 131-0608-00        |                      |          | 14  |   |   |   |   |   | . TERMINAL, PIN: 0.365 L X 0.25 PH, BRZ, GOLD PL | 22526    | 47357            |
| -26              | 131-1078-00        |                      |          | 1   |   |   |   |   |   | . CONNECTOR, RCPT: 28/56 CONTACT                 | 95238    | 600-1156Y256DF30 |
| -27              | 214-1593-02        |                      |          | 1   |   |   |   |   |   | . KEY, CONN PLZN: CKT BD CONN                    | 80009    | 214-1593-02      |
|                  | 131-1895-00        |                      |          | 1   |   |   |   |   |   | . LINK, TERM. CONN: 8, 22 AWG, 1.5 L             | 80009    | 131-1895-00      |
| -28              | 131-0707-00        |                      |          | 2   |   |   |   |   |   | . . CONNECTOR, TERM.: 22-26 AWG, BRS& CU BE GOLD | 22526    | 47439            |
| -29              | 352-0166-01        |                      |          | 1   |   |   |   |   |   | . . CONN BODY, PL, EL: 8 WIRE BROWN              | 80009    | 352-0166-01      |
|                  | 131-1896-00        |                      |          | 1   |   |   |   |   |   | . LINK, TERM. CONN: 8, 22 AWG, 1.5 L             | 80009    | 131-1896-00      |
|                  | 352-0166-02        |                      |          | 1   |   |   |   |   |   | . . HLDR, TERM CONN: 8 WIRE, RED                 | 80009    | 352-0166-02      |
|                  | 131-0707-00        |                      |          | 2   |   |   |   |   |   | . . CONNECTOR, TERM.: 22-26 AWG, BRS& CU BE GOLD | 22526    | 47439            |
|                  | 352-0166-06        |                      |          | 1   |   |   |   |   |   | . CONN BODY, PL, EL: 8 WIRE BLUE                 | 80009    | 352-0166-06      |
|                  |                    |                      |          |     |   |   |   |   |   | (ATTACHING PARTS)                                |          |                  |
| -30              | 213-0088-00        |                      |          | 4   |   |   |   |   |   | SCR, TPG, THD CTG: 4-24 X 0.25 INCH, PNH STL     | 83385    | OBD              |
| -31              | 211-0012-00        | B010100              | B077419  | 2   |   |   |   |   |   | SCREW, MACHINE: 4-40 X 0.375, PNH STL CD PL      | 83385    | OBD              |
|                  | -----              |                      |          | -   |   |   |   |   |   | (STANDARD ONLY)                                  |          |                  |
|                  | 211-0098-00        | B077420              |          | 2   |   |   |   |   |   | SCR, CAP, SOC HD: 4-40 X 0.375 INCH, STL         | 000AH    | OBD              |
|                  | -----              |                      |          | -   |   |   |   |   |   | (STANDARD ONLY)                                  |          |                  |

Replaceable Mechanical Parts—TM 501

| Fig. & Index No. | Tektronix Part No. | Serial/Model No. Eff | Dscont  | Qty | 1 2 3 4 5 | Name & Description                                            | Mfr Code | Mfr Part Number  |
|------------------|--------------------|----------------------|---------|-----|-----------|---------------------------------------------------------------|----------|------------------|
| 1-               | 211-0012-00        | B010100              | B078539 | 2   |           | SCREW,MACHINE:4-40 X 0.375,PNH STL CD PL<br>- (OPTION 2 ONLY) | 83385    | OBD              |
|                  | 211-0098-00        | B078540              |         | 2   |           | SCR,CAP,SOC HD:4-40 X 0.375 INCH,STL<br>- (OPTION 2 ONLY)     | 000AH    | OBD              |
| -32              | 342-0136-00        |                      |         | 2   |           | INSULATOR,WSHR:0.812 OD X 0.0025 INCH THK                     | 04713    | OBD              |
| -33              | 210-0071-00        |                      |         | 2   |           | WASHER,SPR TNSN:0.146 ID X 0.323" OD,STL                      | 78189    | 4706-05-01-0531  |
| -34              | 210-0586-00        | B010100              | B077419 | 2   |           | NUT,PL,ASSEM WA:4-40 X 0.25,STL CD PL<br>- (STANDARD ONLY)    | 83385    | 211-041800-00    |
|                  | 220-0601-00        | B077420              |         | 1   |           | NUT,PLAIN,CAP.:4-40 X 0.25 INCH HEX,BRS<br>- (STANDARD ONLY)  | 73743    | 93261-03         |
|                  | 210-0586-00        | B010100              | B078539 | 2   |           | NUT,PL,ASSEM WA:4-40 X 0.25,STL CD PL<br>- (OPTION 2 ONLY)    | 83385    | 211-041800-00    |
|                  | 210-0601-00        | B078540              |         | 2   |           | EYELET,METALLIC:CAD PLATED<br>- (OPTION 2 ONLY)               | 18680    | A424             |
|                  |                    |                      |         |     |           | - - - * - - -                                                 |          |                  |
| -35              |                    |                      |         | 1   |           | TRANSFORMER:(SEE T1 EPL)<br>(ATTACHING PARTS)                 |          |                  |
| -36              | 212-0576-00        | B010100              | B039999 | 4   |           | SCREW,MACHINE:10-32 X 1.375",HEX,STL                          | 83385    | OBD              |
|                  | 212-0517-00        | B040000              |         | 4   |           | SCREW,MACHINE:10-32 X 1.750INCH,HEX HD STL                    | 83385    | OBD              |
|                  | 210-0812-00        | XB052090             | B091899 | 4   |           | WASHER,NONMETAL:#10,FIBER                                     | 86445    | OBD              |
|                  | 210-0010-00        | B091900              |         | 4   |           | WASHER,LOCK:INT,0.20 ID XO.376" OD,STL                        | 78189    | 1210-00-00-0541C |
|                  | 210-0206-00        | B091900              |         | 1   |           | TERMINAL,LUG:SE #10                                           | 86928    | A373-147-1       |
| -37              | 220-0410-00        |                      |         | 4   |           | NUT,EXTENDED WA:10-32 X 0.375 INCH,STL                        | 83385    | OBD              |
| -38              | 166-0226-00        |                      |         | 4   |           | INS SLV,ELEC:1.125 INCHES LONG<br>- - - * - - -               | 80009    | 166-0226-00      |
|                  |                    |                      |         |     |           | - - - * - - -                                                 |          |                  |
| -39              | 200-0379-01        |                      |         | 1   |           | COVER,ELEC XFMR:                                              | 80009    | 200-0379-01      |
| -40              | 210-0201-00        |                      |         | 1   |           | TERMINAL,LUG:SE #4<br>(ATTACHING PARTS)                       | 86928    | A373-157-2       |
|                  |                    |                      |         |     |           | - - - * - - -                                                 |          |                  |
| -41              | 210-0586-00        |                      |         | 1   |           | NUT,PL,ASSEM WA:4-40 X 0.25,STL CD PL<br>- - - * - - -        | 83385    | 211-041800-00    |
|                  |                    |                      |         |     |           | - - - * - - -                                                 |          |                  |
| -42              | 352-0076-00        | B010100              | B049999 | 1   |           | FUSEHOLDER:W/HARDWARE                                         | 75915    | 342012-L         |
|                  | 352-0362-00        | B050000              |         | 1   |           | FUSEHOLDER: W/MOUNTING HARDWARE<br>(ATTACHING PARTS)          | 75915    | 345001           |
|                  |                    |                      |         |     |           | - - - * - - -                                                 |          |                  |
| -43              | 210-0873-00        |                      |         | 1   |           | WASHER,NONMETAL:0.5 ID X 0.688 INCH OD,NPRN<br>- - - * - - -  | 70485    | OBD              |
|                  |                    |                      |         |     |           | - - - * - - -                                                 |          |                  |
| -44              | 358-0161-00        |                      |         | 1   |           | BSHG,STRAIN RLF:FOR 0.50 INCH HOLE,PLASTIC                    | 28520    | SR5P4            |
| -45              | 161-0033-04        | B010100              | B082459 | 1   |           | CABLE ASSY,PWR:                                               | 16428    | KH854-2          |
|                  | 161-0033-25        | B082460              |         | 1   |           | CABLE ASSY,PWR:3,18 AWG,125V,84.0 L                           | 16428    | OBD              |
|                  | 210-0201-00        | XB073290             |         | 1   |           | TERMINAL,LUG:SE #4<br>(ATTACHING PARTS)                       | 86928    | A373-157-2       |
|                  |                    |                      |         |     |           | - - - * - - -                                                 |          |                  |
|                  | 210-0586-00        | XB073290             |         | 1   |           | NUT,PL,ASSEM WA:4-40 X 0.25,STL CD PL<br>- - - * - - -        | 83385    | 211-041800-00    |
|                  |                    |                      |         |     |           | - - - * - - -                                                 |          |                  |
| -46              | 333-1560-00        |                      |         | 1   |           | PANEL,REAR:                                                   | 80009    | 333-1560-00      |
| -47              | 426-0876-00        | B010100              | B075979 | 1   |           | FRAME ASSEMBLY:CABINET                                        | 80009    | 426-0876-00      |
|                  | 426-0876-02        | B075080              |         | 1   |           | FRAME ASSEMBLY:CABINET                                        | 80009    | 426-0876-02      |
|                  | 334-3379-01        | XB080730             |         | 1   |           | MARKER,IDENT:MARKED GROUND SYMBOL                             | 80009    | 334-3379-01      |
|                  | 198-2070-00        |                      |         | 1   |           | WIRE SET,ELEC:                                                | 80009    | 198-2070-00      |
|                  | 131-2065-00        | XB084930             |         | 3   |           | . TERM,QIK DISC:18-22 AWG,BRASS TIN PLATED                    | 00779    | 2-350799-2       |

FIG. 1 EXPLODED

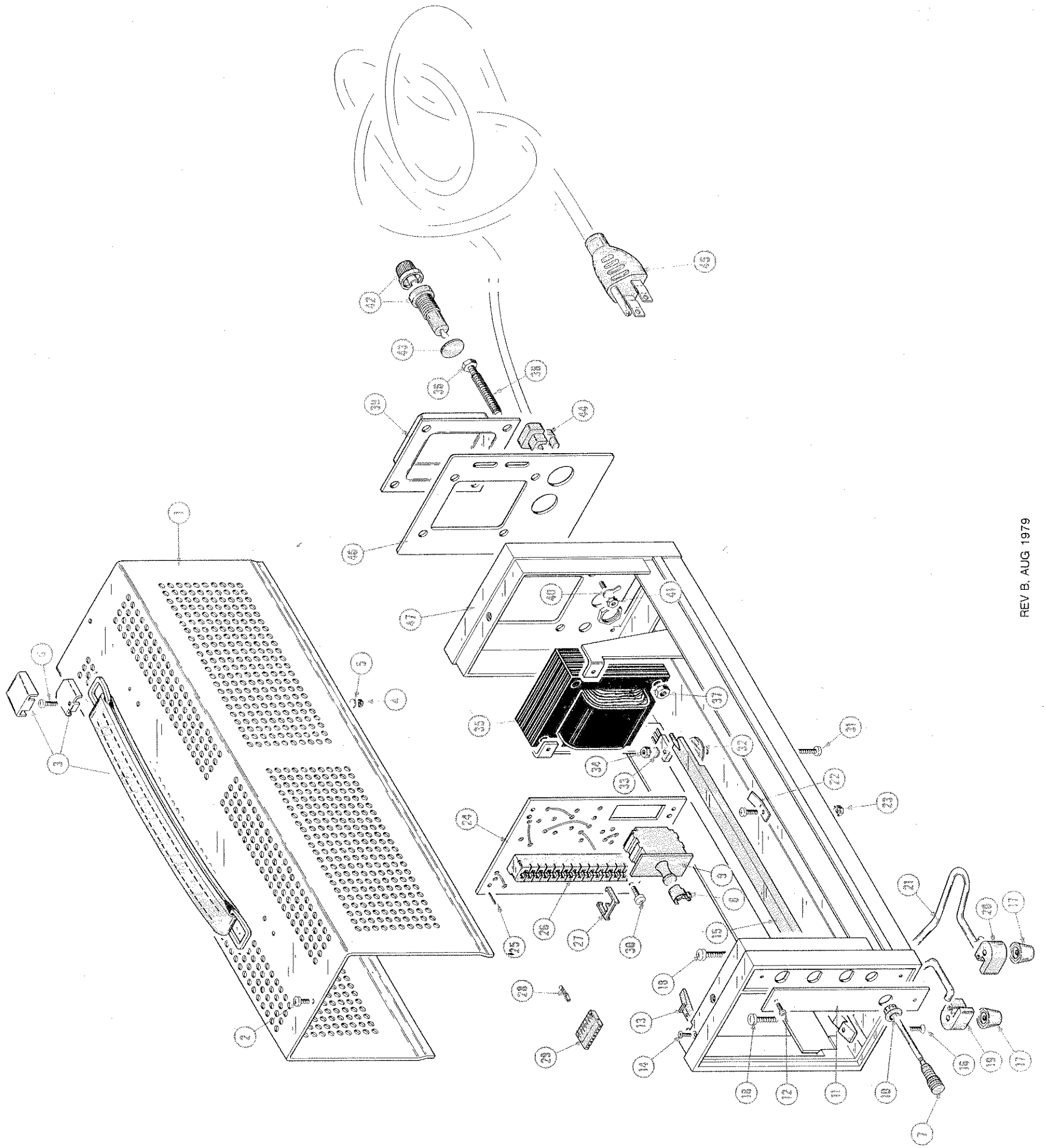

TM501 POWER MODULE

REV. B. AUG 1979



STANDARD ACCESSORIES

| Index<br>No. | Tektronix<br>Part No. | Serial/Model<br>No. Eff | No.<br>Dscnt | Qty |   |   |   |   |   | Name & Description        | Mfr   |                 |
|--------------|-----------------------|-------------------------|--------------|-----|---|---|---|---|---|---------------------------|-------|-----------------|
|              |                       |                         |              |     | 1 | 2 | 3 | 4 | 5 |                           | Code  | Mfr Part Number |
|              | 070-1304-00           |                         |              | 1   |   |   |   |   |   | MANUAL, TECH: INSTRUCTION | 80009 | 070-1304-00     |



## **MANUAL CHANGE INFORMATION**

At Tektronix, we continually strive to keep up with latest electronic developments by adding circuit and component improvements to our instruments as soon as they are developed and tested.

Sometimes, due to printing and shipping requirements, we can't get these changes immediately into printed manuals. Hence, your manual may contain new change information on following pages.

A single change may affect several sections. Since the change information sheets are carried in the manual until all changes are permanently entered, some duplication may occur. If no such change pages appear following this page, your manual is correct as printed.

## **SERVICE NOTE**

Because of the universal parts procurement problem, some electrical parts in your instrument may be different from those described in the Replaceable Electrical Parts List. The parts used will in no way alter or compromise the performance or reliability of this instrument. They are installed when necessary to ensure prompt delivery to the customer. Order replacement parts from the Replaceable Electrical Parts List.

# CALIBRATION TEST EQUIPMENT REPLACEMENT

## Calibration Test Equipment Chart

This chart compares TM 500 product performance to that of older Tektronix equipment. Only those characteristics where significant specification differences occur, are listed. In some cases the new instrument may not be a total functional replacement. Additional support instrumentation may be needed or a change in calibration procedure may be necessary.

Comparison of Main Characteristics

|                                 |                                                                                                                      |                                                                                                               |
|---------------------------------|----------------------------------------------------------------------------------------------------------------------|---------------------------------------------------------------------------------------------------------------|
| DM 501 replaces 7D13            |                                                                                                                      |                                                                                                               |
| PG 501 replaces 107             | PG 501 - Risetime less than 3.5 ns into 50 Ω.                                                                        | 107 - Risetime less than 3.0 ns into 50 Ω.                                                                    |
| 108                             | PG 501 - 5 V output pulse; 3.5 ns Risetime                                                                           | 108 - 10 V output pulse<br>1 ns Risetime                                                                      |
| PG 502 replaces 107             |                                                                                                                      |                                                                                                               |
| 108                             | PG 502 - 5 V output                                                                                                  | 108 - 10 V output                                                                                             |
| 111                             | PG 502 - Risetime less than 1 ns; 10 ns<br>Pretrigger pulse delay                                                    | 111 - Risetime 0.5 ns; 30 to 250 ns<br>Pretrigger pulse delay                                                 |
| PG 508 replaces 114             | Performance of replacement equipment is the same or better than equipment being replaced.                            |                                                                                                               |
| 115                             |                                                                                                                      |                                                                                                               |
| 2101                            |                                                                                                                      |                                                                                                               |
| PG 506 replaces 106             | PG 506 - Positive-going trigger output signal at least 1 V; High Amplitude output, 60 V.                             | 106 - Positive and Negative-going trigger output signal, 50 ns and 1 V; High Amplitude output, 100 V.         |
| 067-0502-01                     | PG 506 - Does not have chopped feature.                                                                              | 0502-01 - Comparator output can be alternately chopped to a reference voltage.                                |
| SG 503 replaces 190, 190A, 190B | SG 503 - Amplitude range 5 mV to 5.5 V p-p.                                                                          | 190B - Amplitude range 40 mV to 10 V p-p.                                                                     |
| 191                             | SG 503 - Frequency range 250 kHz to 250 MHz.                                                                         | 0532-01 - Frequency range 65 MHz to 500 MHz.                                                                  |
| 067-0532-01                     |                                                                                                                      |                                                                                                               |
| SG 504 replaces 067-0532-01     | SG 504 - Frequency range 245 MHz to 1050 MHz.                                                                        | 0532-01 - Frequency range 65 MHz to 500 MHz.                                                                  |
| 067-0650-00                     |                                                                                                                      |                                                                                                               |
| TG 501 replaces 180, 180A       | TG 501 - Trigger output-slaved to marker output from 5 sec through 100 ns. One time-mark can be generated at a time. | 180A - Trigger pulses 1, 10, 100 Hz; 1, 10, and 100 kHz. Multiple time-marks can be generated simultaneously. |
| 181                             | TG 501 - Trigger output-slaved to market output from 5 sec through 100 ns. One time-mark can be generated at a time. | 181 - Multiple time-marks                                                                                     |
| 184                             |                                                                                                                      | 184 - Separate trigger pulses of 1 and 0.1 sec; 10, 1, and 0.1 ms; 10 and 1 μs.                               |
| 2901                            | TG 501 - Trigger output-slaved to marker output from 5 sec through 100 ns. One time-mark can be generated at a time. | 2901 - Separate trigger pulses, from 5 sec to 0.1 μs. Multiple time-marks can be generated simultaneously.    |

**NOTE: All TM 500 generator outputs are short-proof. All TM 500 plug-in instruments require TM 500-Series Power Module.**

REV B, JUN 1978.







## Free Manuals Download Website

<http://myh66.com>

<http://usermanuals.us>

<http://www.somanuals.com>

<http://www.4manuals.cc>

<http://www.manual-lib.com>

<http://www.404manual.com>

<http://www.luxmanual.com>

<http://aubethermostatmanual.com>

Golf course search by state

<http://golfingnear.com>

Email search by domain

<http://emailbydomain.com>

Auto manuals search

<http://auto.somanuals.com>

TV manuals search

<http://tv.somanuals.com>