



PLEASE CHECK FOR CHANGE INFORMATION
AT THE REAR OF THIS MANUAL.

DM 501A DIGITAL MULTIMETER

Francais Deutsch 日本語

INSTRUCTION MANUAL

Tektronix, Inc.
P.O. Box 500
Beaverton, Oregon 97077

070-2749-00
Product Group 75

Serial Number 701-450

First Printing JUN 1979
Revised APR 1986

Copyright ©1974, 1980 Tektronix, Inc. All rights reserved. Contents of this publication may not be reproduced in any form without the written permission of Tektronix, Inc.

Products of Tektronix, Inc. and its subsidiaries are covered by U.S. and foreign patents and/or pending patents.

TEKTRONIX, TEK, SCOPE-MOBILE, and  are registered trademarks of Tektronix, Inc.

Printed in U.S.A. Specification and price change privileges are reserved.

Copyright © 1974, 1980 durch Tektronix, Inc. Alle Rechte vorbehalten. Der Inhalt dieser Publikation darf ohne Genehmigung von Tektronix, Inc. nicht weitergegeben werden.

Produkte von Tektronix, Inc. und seinen Tochtergesellschaften sind durch US- und Auslandspatente und/oder schwebende Patente abgedeckt.

TEKTRONIX, TEK, SCOPE-MOBILE und  sind geschützte Warenzeichen von Tektronix, Inc.

Gedruckt in U.S.A. Spezifikations- und Preisänderungen bleiben vorbehalten.

Copyright ©1974, 1980 TEKTRONIX INC. Tous droits réservés. Le contenu de ce manuel ne peut être reproduit sous quelque forme que ce soit sans l'accord de Tektronix Inc.

Tous les produits TEKTRONIX sont brevetés US et Etranger et les logotypes TEKTRONIX, TEK SCOPE MOBILE,  sont déposés.

Imprimé aux USA. TEKTRONIX se réserve le droit de modifier : caractéristiques et prix dans le cadre de développements technologiques.

© 1974, 1980 年版權所有テクトロニクス社。不許複製。

TEKTRONIX、TEK、SCOPE-MOBILE、 はテクトロニクス社の登録商標です。

米国にて印刷。仕様及び価格は予告なく変更する場合があります。

INSTRUMENT SERIAL NUMBERS

Each instrument has a serial number on a panel insert, tag, or stamped on the chassis. The first number or letter designates the country of manufacture. The last five digits of the serial number are assigned sequentially and are unique to each instrument. Those manufactured in the United States have six unique digits. The country of manufacture is identified as follows:

B000000	Tektronix, Inc., Beaverton, Oregon, USA
100000	Tektronix Guernsey, Ltd., Channel Islands
200000	Tektronix United Kingdom, Ltd., London
300000	Sony/Tektronix, Japan
700000	Tektronix Holland, NV, Heerenveen, The Netherlands

OPERATORS SAFETY SUMMARY

The general safety information in this part of the summary is for both operating and servicing personnel. Specific warnings and cautions will be found throughout the manual where they apply, but may not appear in this summary.

TERMS

In This Manual

CAUTION statements identify conditions or practices that could result in damage to the equipment or other property.

WARNING statements identify conditions or practices that could result in personal injury or loss of life.

As Marked on Equipment

CAUTION indicates a personal injury hazard not immediately accessible as one reads the marking, or a hazard to property including the equipment itself.

DANGER indicates a personal injury hazard immediately accessible as one reads the marking.

SYMBOLS

In This Manual



This symbol indicates where applicable cautionary or other information is to be found.

As Marked on Equipment



DANGER — High voltage.



Protective ground (earth) terminal.



ATTENTION — refer to manual.

Power Source

This product is intended to operate from a power source that will not apply more than 250 volts rms between the supply conductors or between either supply conductor and ground. A protective ground connection by way of the grounding conductor in the power cord is essential for safe operation.

Grounding the Product

This product is grounded through the grounding conductor of the power cord. To avoid electrical shock, plug the power cord into a properly wired receptacle before connecting to the product input or output terminals. A protective ground connection by way of the grounding conductor in the power cord is essential for safe operation.

Danger Arising From Loss of Ground

Upon loss of the protective-ground connection, all accessible conductive parts (including knobs and controls that may appear to be insulating) can render an electric shock.

Use the Proper Power Cord

Use only the power cord and connector specified for your product.

Use only a power cord that is in good condition.

Refer cord and connector changes to qualified service personnel.

Use the Proper Fuse

To avoid fire hazard, use only the fuse specified in the parts list for your product, and which is identical in type, voltage rating, and current rating.

Refer fuse replacement to qualified service personnel.

Do Not Operate in Explosive Atmospheres

To avoid explosion, do not operate this product in an atmosphere of explosive gases unless it has been specifically certified for such operation.

Do Not Operate Without Covers

To avoid personal injury, do not operate this product without covers or panels installed. Do not apply power to the plug-in via a plug-in extender.

SERVICING SAFETY SUMMARY

FOR QUALIFIED SERVICE PERSONNEL ONLY

Refer also to the preceding Operators Safety Summary.

Do Not Service Alone

Do not perform internal service or adjustment of this product unless another person capable of rendering first aid and resuscitation is present.

Use Care When Servicing With Power On

Dangerous voltages exist at several points in this product. To avoid personal injury, do not touch exposed connections and components while power is on.

Disconnect power before removing protective panels, soldering, or replacing components.

Power Source

This product is intended to operate from a power source that will not apply more than 250 volts rms between the supply conductors or between either supply conductor and ground. A protective ground connection by way of the grounding conductor in the power cord is essential for safe operation.

RECAPITULATIF DES CONSIGNES DE SECURITE

Le texte ci-dessous, divisé en deux parties, résume les consignes de sécurité qui doivent être observées à toutes les phases de l'utilisation, de la maintenance et des réparations de l'appareil.

Consignes de sécurité destinées aux utilisateurs. Les consignes générales de sécurité s'adressent à la fois aux utilisateurs et au personnel de maintenance. Avertissements et précautions à respecter sont annotés au long de ce manuel, à chaque fois que l'utilisation du DM 501A l'exige.

TERMES

Dans ce manuel

Les nota dénommés «Attention» indiquent les circonstances ou les manipulations pouvant provoquer des détériorations de l'appareil ou de tout autre équipement associé.

Les nota dénommés «Avertissement» indiquent les circonstances ou les manipulations pouvant entraîner blessures corporelles, éventuellement mortelles.

Gravés sur l'appareil

CAUTION (attention). Ce mot identifie les zones de risque de blessure, non immédiatement perceptibles ou un risque éventuel de détérioration de l'appareil.

DANGER. Ce mot indique les zones de risque immédiat pouvant entraîner blessures ou mort.

SYMBOLES

Dans ce manuel



Ce symbole de sécurité signifie : se reporter au manuel.

Gravés sur l'appareil



DANGER – Haute tension



Protection à la masse



ATTENTION – se reporter au manuel

Mise à la masse du produit

La mise à la masse du DM 501A s'effectue à l'aide d'un conducteur de masse du cordon d'alimentation. Pour éviter tout choc électrique, insérer la prise du cordon d'alimentation dans une prise de distribution correspondante avant de connecter l'entrée ou les terminaisons de sortie de l'appareil. Pour utiliser l'appareil en toute sécurité, une connexion à la borne de masse au moyen du conducteur de masse au cordon d'alimentation est indispensable.

Utiliser le cordon d'alimentation approprié

N'utiliser que le cordon d'alimentation et la prise recommandés pour votre appareil. N'utiliser qu'un cordon d'alimentation en bon état. Pour effectuer les changements de cordons d'alimentation et de prises, faire appel à un personnel qualifié.

Utiliser le fusible approprié

Pour éviter tout risque d'accident (incendie...) n'utiliser que le fusible recommandé pour votre appareil. Les remplacements de fusible doivent toujours être en harmonie avec le type, la vitesse de tension et la vitesse de courant. Seul, un personnel compétent peut procéder à un changement de fusible.

Ne pas utiliser l'appareil en atmosphère explosives

Pour éviter toute explosion, ne pas utiliser cet appareil dans une atmosphère de gaz explosifs à moins qu'une telle utilisation n'ait été spécifiquement reconnue possible.

Ne pas ôter les capots ou panneaux

Pour éviter tout incident corporel grave, ne pas ôter les panneaux ou capots de protection de l'appareil. Celui-ci ne doit pas fonctionner tant que les panneaux et capots n'ont pas correctement été mis en place.

Ne pas faire fonctionner l'appareil sans les capots et panneaux (pour les tiroirs de la série TM 500 uniquement)

Pour éviter tout incident corporel grave, ne pas utiliser l'appareil alors que les capots ou panneaux ne sont pas remis en place. N'appliquer aucune tension au tiroir par l'intermédiaire d'un cordon d'extension.

CONSIGNES DE SECURITE

UNIQUEMENT DESTINEES AU PERSONNEL DE MAINTENANCE

Il est indispensable de se référer également aux consignes de sécurité à l'attention des utilisateurs.

Ne jamais être seul pour procéder à l'entretien de l'appareil.

Agir avec précaution si l'on effectue une réparation alors que l'appareil est sous tension

Des tensions dangereuses existent en divers points de l'appareil. Pour éviter tout risque de blessure corporelle, ne touchez ni aux connexions exposées ni aux composants alors que l'appareil est sous tension. Couper l'alimentation avant d'enlever les panneaux de protection, d'effectuer des soudures ou de remplacer des composants.

Source d'alimentation

Ce produit est conçu pour fonctionner à partir d'une source d'alimentation qui n'appliquera pas plus de 250 V efficaces entre les conducteurs d'alimentation ou entre chaque conducteur d'alimentation et la terre. Pour utiliser l'appareil en toute sécurité, une connexion à la masse au moyen d'un conducteur de masse dans le cordon d'alimentation est indispensable.

SICHERHEITSANGABEN

Der folgende Text enthält in zwei Teilen Angaben über Sicherheitsvorkehrungen, die jederzeit bei Betrieb, Service und Reparatur des Gerätes beachtet werden müssen.

SICHERHEITSANGABEN FÜR DEN ANWENDER

Die allgemeinen Sicherheitsinformationen in diesem Teil der Angaben dienen dem Anwender- und Servicepersonal. Spezielle Warnungen und Hinweise sind überall im Handbuch zu finden, müssen jedoch in diesen Angaben nicht erscheinen.

BEGRIFFE

In diesem Handbuch:

VORSICHTSHINWEISE erläutern Bedingungen, die zur Zerstörung des Gerätes oder anderer Gegenstände führen könnten.

WARNUNGSHINWEISE erläutern Bedingungen, die zu Personenschäden führen können oder lebensgefährlich sind.

Markierungen auf dem Gerät:

CAUTION – VORSICHT weist darauf hin, daß durch zufälliges Berühren an einer nicht unmittelbar zugänglichen Stelle Personenschaden entstehen kann, oder Schaden am Gerät selbst.

DANGER – GEFAHR weist darauf hin, daß durch zufälliges Berühren an einer zugänglichen Stelle Personenschaden entstehen kann.

SYMBOLE

In diesem Handbuch:



Dieses Symbol zeigt an, wo Vorsicht walten zu lassen ist, oder wo Informationen zu finden sind.

Markierungen auf dem Gerät:



GEFAHR – Hochspannung.



Schutzerdungskontakt



ACHTUNG – beziehen Sie sich auf das Handbuch

Masseanschluß des Gerätes

Dieses Gerät wird über den Schutzleiter der Versorgungseinheit mit Erdpotential verbunden.

Zur Vermeidung von elektrischen Schlägen ist vor der Beschaltung der Ein- und Ausgänge der Netzstecker in eine korrekt verdrahtete Steckdose einzustecken. Verwenden Sie den Schutzleiter nicht als einzige Verbindung zwischen zwei oder mehreren Geräten. Zur Vermeidung von elektrischen Schlägen sind die Geräte untereinander mit separaten Leitungen zu verbinden.

Verwendung eines richtigen Netzkabels

Verwenden Sie nur Netzkabel, die für die Versorgungseinheit geeignet sind und die sich in gutem Zustand befinden.

Für detaillierte Informationen über Kabel und Stecker beziehen Sie sich auf Abbildungen innerhalb des Handbuches.

Ein Austausch von Kabeln und Steckern ist nur von geschultem Personal vorzunehmen.

Verwendung einer richtigen Sicherung

Zur Vermeidung von Brandschäden sind nur Sicherungen zu verwenden, die in den Teilelisten dieses Gerätes aufgeführt sind und die in Spannungs- und Stromwert entsprechend sind.

Ersatz von Sicherungen ist nur von geschultem Personal vorzunehmen.

Arbeiten Sie nicht in explosiver Umgebung

Zur Vermeidung von Explosionen ist die Inbetriebnahme dieses Gerätes in explosiver Umgebung zu unterlassen, wenn das Gerät nicht dafür geeignet ist.

Entfernen Sie keine Gehäuseabdeckungen

Zur Vermeidung von Personenschäden sind keine Gehäuseteile zu entfernen. Auch ist das Gerät ohne Gehäuse nicht in Betrieb zu nehmen.

Arbeiten Sie nicht ohne Gehäuseabdeckung

Zur Vermeidung von Personenschäden ist das Gerät nicht ohne Gehäuse in Betrieb zu nehmen. Der Einschub sollte nicht über einen Verlängerungsadapter betrieben werden.

SICHERHEITSANGABEN FÜR DEN SERVICE**NUR FÜR GESCHULTES PERSONAL**

Beziehen Sie sich auch auf die vorangehenden Sicherheitsangaben für den Anwender.

Führen Sie keine Servicetätigkeiten alleine durch

Nehmen Sie an dem Gerät keine Service- oder Einstellarbeiten vor, wenn nicht eine andere Person verfügbar ist, um im Bedarfsfall Erste Hilfe oder Wiederbelebungsversuche zu leisten.

Lassen Sie besondere Vorsicht walten, wenn Sie an einem unter Spannung stehenden Gerät arbeiten

An verschiedenen Stellen im Gerät liegen hohe und damit gefährliche Spannungen. Zur Vermeidung von Personenschäden sind solche Stellen und Bauteile nicht zu berühren, während Betriebsspannung anliegt.

Vor dem Entfernen von Gehäuseteilen, Löten oder Ersetzen von Bauteilen ist immer die Betriebsspannung zu entfernen.

Netzspannungsversorgung

Die Betriebsspannung für dieses Gerät darf $250 V_{eff}$ nicht überschreiten und ist an die Versorgungsleitungen bzw. an eine Versorgungsleitung und Masse anzulegen. Innerhalb des Netzanschlußkabels muß ein Schutzleiter vorhanden sein, der mit Gerätemasse verbunden ist.

ご使用の前に

DM 501A 型を安全にお使いいただくために、操作、点検、修理上の注意事項が、大きく2項目に分れて述べられています。

操作上の注意

操作上の注意は、オペレータの方にもサービス・エンジニアの方にも共通しています。このマニュアルの各所に特別の注意書きがありますが、これによく従ってください。

用語

マニュアル中の用語

警告 (WARNING) の項は人体に損傷を及ぼしたり危険を与える恐れのある場合の注意です。

注意 (CAUTION) の項は本機器または他の接続機器に損傷を及ぼす恐れのある場合の注意です。

機器上の用語

CAUTIONと記されている部分は人体や本機器に損傷を及ぼす恐れがありますのでご注意ください。

DANGERと記されている部分は、人体に危険を及ぼしますので手を触れないで下さい。

記号

マニュアル中の記号



注意等が記述されています。

機器上の記号



DANGER——高電圧



保護用接地ターミナル



ATTENTION——マニュアル参照

電源モジュールの接地

DM 501A 型は電源モジュールの接地線によって接地されます。電氣的ショックを防止するため、電源プラグを電源に接続するのは、入出力コネクタを接続する前に行ってください。

2台またはそれ以上の機器の間だけで接地線を接続するだけでなく、電氣的ショックを避けるため接地端子に接地して下さい。

電源コード

機器に適合する電源コード及びコネクタを使用して下さい。電源コードは損傷のないものをお使い下さい。

電源コードとコネクタに関する詳細は、TM500電源本体のマニュアルをご参照下さい。

コードとコネクタの交換の際は当社エンジニアにおたずね下さい。

ヒューズ

危険防止のため本機器のパーツ・リストに記載されている、形状、定格電圧、定格電流と同等のヒューズをご使用下さい。

ヒューズ交換の際は、当社エンジニアにおたずね下さい。

爆発防止

危険防止のため、爆発性のガスが周囲にあるような所では作動させないで下さい。

カバー、パネル

人体への損傷を避けるため、機器のカバーやパネルは取りはずさないで下さい。カバーやパネルをはずしたまま、機器を作動させないで下さい。

カバーの扱いについて

人体への損傷を避けるため、機器のカバーやパネルを取りはずしたまま作動させないで下さい。またプラグイン・エクステンダによって電源と接続しないで下さい。

サービス上の注意

サービス・エンジニアの方へ

“操作上の注意”を先にお読み下さい。

1人でサービスを行わないで下さい。

機器の内部点検または修理は、万一の場合に備えて応急処置のできる人がいる所で行って下さい。

電源を入れた場合の注意

機器内部には高電圧の部分があります。人体への危険を防止するため、電源がはいっている時は、露出している接続部分や部品には手を触れないで下さい。

パネルの取りはずし、ハンダ付、部品の交換を行う前には、電源を必ず切って下さい。

電源

DM 501A 型は電源コードの線間あるいは電源コードとグラウンド間が250Vrms以内の範囲の電源で作動します。安全のために電源コードのアース線できちんと接地して下さい。

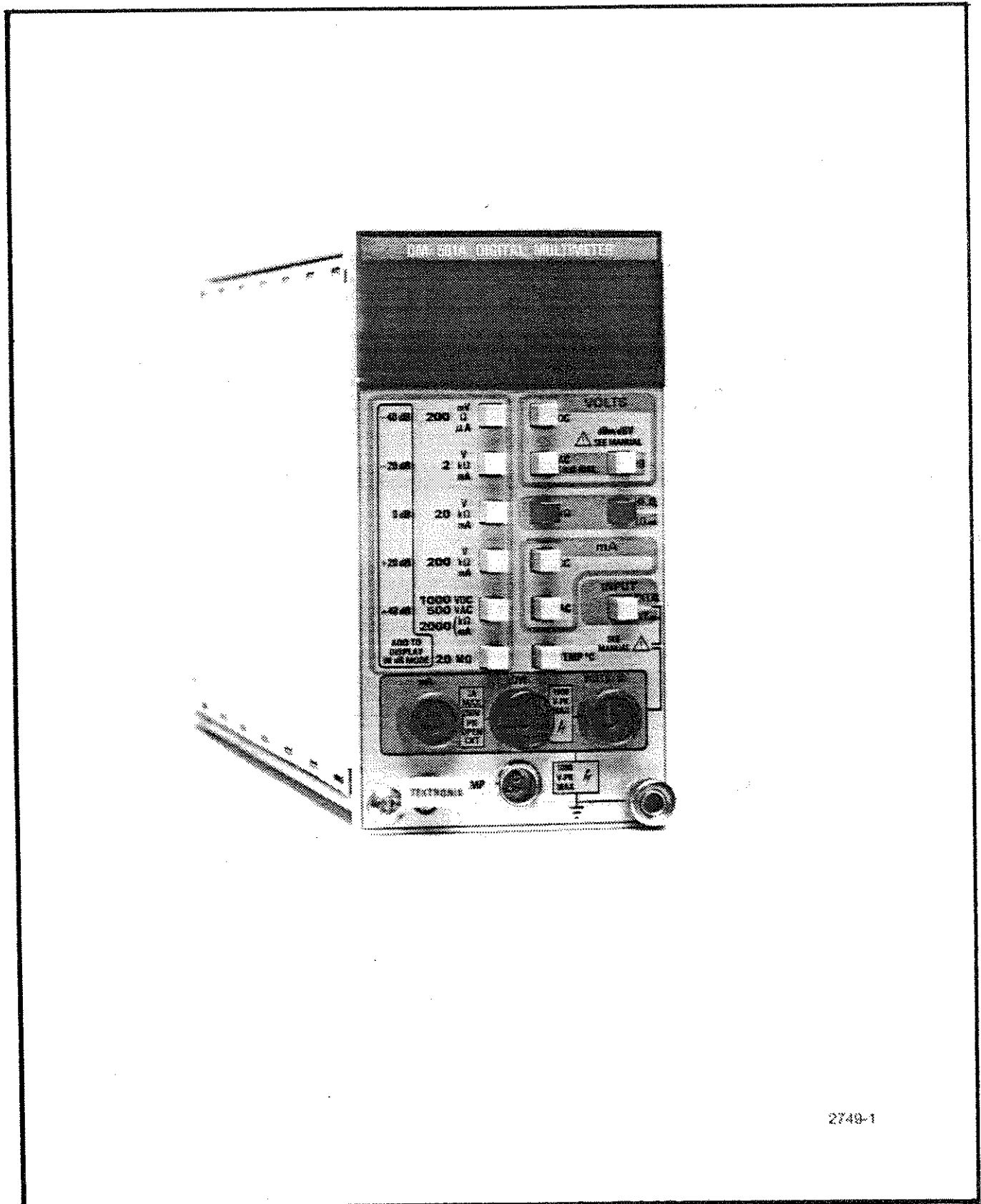

2749-1

DM 501A Digital Multimeter.

SPECIFICATION

Introduction

The DM 501A Digital Multimeter measures dc voltage and current, ac voltage and current, dBm, dBV, resistance, and temperature. The ac functions are ac coupled only, true rms responding. All the functions and ranges are front panel push button selected, including the rear interface connector input.

Readout in dBm or dBV is selected by an internal jumper. The unit is shipped with the internal jumper in the dBm position.

The readout is a 0.4" high, 4 1/2 digit display using seven segment LED. The decimal point is automatically positioned depending on the selected operating range of the instrument. Polarity indication is automatic.

Accessories

Standard accessories include this instruction manual, a set of test leads and the TEKTRONIX P6601 temperature probe with its instruction manual.

The P6601 temperature probe and temperature measurement capabilities are deleted for Option 2 instruments.

Performance Conditions

The electrical characteristics are valid only if the DM 501A has been calibrated at an ambient temperature between +21°C and +25°C and is operating at an ambient temperature between 0°C and +50°C, unless otherwise noted.

Items listed in the Performance Requirements column of the Electrical Characteristics are verified by completing the Performance Check in the Calibration section of this manual. These items are either explanatory notes or performance characteristics for which no limits are specified.

Table 1-1

ELECTRICAL CHARACTERISTICS (Front Panel)

Characteristics	Performance Requirements	Supplemental Information
DC VOLTMETER		
Accuracy for 200 mV, 2 V, 20 V 200 V and 1000 V ranges +18°C to +28°C		
200 mV range	±(0.05% of reading + 0.015% of full scale)	
2 V to 200 V ranges	±(0.05% of reading + 0.01% of full scale)	
1000 V range	±(0.05% of reading + 0.02% of full scale)	
0°C to +18°C, +28°C to +50°C		
200 mV to 200 V range	±(0.1% of reading + 0.025% of full scale)	
1000 V range	±(0.1% of reading + 0.05% of full scale)	

Table 1-1 (cont)

Characteristics	Performance Requirements	Supplemental Information
DC VOLTMETER (cont)		
Common Mode Rejection Ratio	100 dB at dc. 80 dB at 50 and 60 Hz.	With a 1 k Ω unbalance.
Normal Mode Rejection Ratio	60 dB at 50 or 60 Hz +0.2 Hz.	
Maximum Resolution		10 μ V.
Step Response Time		<1 second.
Input Resistance		10 M Ω \pm 0.5%.
Maximum Input Voltage		
VOLTS/ Ω to LOW		1000 V peak.
VOLTS/ Ω to ground		1000 V peak.
LOW to ground		1000 V peak.
Input Connectors		Front panel (EXT) or rear interface (INT)
AC VOLTMETER (TRUE RMS)		
Accuracy for 200 mV, 2 V, 20 V 200 V and 500 V ranges +18°C to +28°C		Input signal must be between 5% and 100% of full scale. The 500 V range requires a dynamic input signal between 500 V and 100 V rms.
200 mV to 200 V ranges		
40 Hz to 10 kHz	\pm (0.6% of reading + 0.05% of full scale)	
20 Hz to 40 Hz and 10 kHz to 20 kHz	\pm (1.0% of reading + 0.05% of full scale)	
500 V range		
40 Hz to 10 kHz	\pm (0.6% of reading + 0.2% of full scale)	
20 Hz to 40 Hz and 10 kHz to 20 kHz	\pm (1.0% of reading + 0.2% of full scale)	
0°C to +18°C, +28°C to +50°C		
200 mV to 200 V ranges		
40 Hz to 10 kHz	\pm (0.8% of reading + 0.075% of full scale)	
20 Hz to 40 Hz and 10 kHz to 20 kHz	\pm (1.3% of reading + 0.075% of full scale)	
500 V range		
40 Hz to 10 kHz	\pm (0.8% of reading + 0.3% of full scale)	
20 Hz to 40 Hz and 10 kHz to 20 kHz	\pm (1.3% of reading + 0.3% of full scale)	

Table 1-1 (cont)

Characteristics	Performance Requirements	Supplemental Information
AC VOLTMETER (TRUE RMS) (cont)		
Common Mode Rejection Ratio	≥ 60 dB at 50 and 60 Hz.	With a 1 k Ω unbalance.
Maximum Resolution		10 μ V.
Response Time		<2 seconds.
Input Impedance		10 M Ω \pm 0.5% paralleled by 160 pF.
Input Connectors		Front panel (EXT) or rear interface (INT).
Maximum Input Voltage		500 V rms or 600 Vdc not to exceed 1000 V peak.
VOLTS/ Ω to LOW		
VOLTS/ Ω to ground		1000 V peak.
LOW to ground		1000 V peak.
Crest Factor		4 at full scale.
DECIBELS (dB)—TRUE RMS		
Accuracy for -40 dB, -20 dB, 0 dB, +20 dB and +40 dB ranges		
+18°C to +28°C		
+20 dB to -15 dB	\pm 0.5 dB 20 Hz to 20 kHz	
-15 dB to -20 dB	\pm 0.5 dB 20 Hz to 2 kHz \pm 1.5 dB 2 kHz to 10 kHz	Typically < \pm 2.5 dB 10 kHz to 20 kHz.
0°C to +18°C, +28°C to +50°C		
+20 dB to -15 dB	\pm 1.1 dB 20 Hz to 20 kHz	
-15 dB to -20 dB	\pm 1.1 dB 20 Hz to 2 kHz \pm 2.1 dB 2 kHz to 10 kHz	Typically < \pm 3.1 dB 10 kHz to 20 kHz.
Maximum Resolution		0.1 dB.
Response Time		<2 seconds.
Input Impedance		10 M Ω paralleled by 160 pF.
Maximum Input Voltage		500 v rms or 600 Vdc not to exceed 1000 V peak. ^a
VOLTS/ Ω to LOW		
VOLTS/ Ω to ground		1000 V peak.
LOW to ground		1000 V peak.

^aEquivalent to 54 dBV or 56.2 dBm.

Table 1-1 (cont)

Characteristics	Performance Requirements	Supplemental Information
Crest Factor		4 at full scale.
Ref Voltage		
dBV		1 V.
dBm		0.7746-V (1 mW dissipated into 600 Ω). Selected by internal jumper.
Input Connectors		Front panel (EXT) or rear interface (INT).

OHMMETER

Accuracy for 200 Ω, 2 kΩ, 20 kΩ, 200 kΩ, 2000 kΩ and 20 MΩ ranges.				
+18°C to +28°C				
200 Ω to 200 kΩ LO Ω 2 kΩ to 2000 kΩ HI Ω	±(0.15% of reading + 0.015% of full scale)			
2000 kΩ LO	±(0.3% of reading + 0.015% of full scale)			
20 MΩ HI Ω	±(0.5% of reading + 0.015% of full scale)			
0°C to +18°C, +28°C to +50°C				
200 Ω to 200 kΩ LO Ω 2 kΩ to 2000 kΩ HI Ω	±(0.3% of reading + 0.025% of full scale)			
2000 kΩ LO Ω 20 MΩ HI Ω	±(1.2% of reading + 0.025% of full scale)			
Maximum Input Volts Any Range		250 V peak.		
Measuring Current and Full Scale Volts		Range	Source Current	
HI Ω			V Max at Full Scale	
		200 Ω	1.0 mA	0.2 V
		2 kΩ	1.0 mA	2.0 V
		20 kΩ	0.1 mA	2.0 V
		200 kΩ	10.0 μA	2.0 V
		2000 kΩ	1.0 μA	2.0 V
		20 MΩ	0.1 μA	2.0 V
LO Ω				
		200 Ω	1.0 mA	0.2 V
		2 kΩ	0.1 mA	0.2 V
		20 kΩ	10.0 μA	0.2 V
		200 kΩ	1.0 μA	0.2 V
		2000 kΩ	0.1 μA	0.2 V
		20 MΩ	0.1 μA	2.0 V

Table 1-1 (cont)

Characteristics	Performance Requirements	Supplemental Information	
Maximum Resolution		10 mΩ.	
Response Time		<2 seconds, 200 Ω to 2000 kΩ. <10 seconds, 20 MΩ scale.	
Maximum Open Circuit Voltage		<6 V.	
Input Connectors		Front panel (EXT) or rear interface (INT).	
DC AMMETER			
Accuracy for 200 μA, 2 mA, 20 mA, 200 mA and 2000 mA ranges. +18°C to +28°C	±(0.2% of reading + 0.015% of full scale)		
0°C to +18°C, +28°C to +50°C	±(0.3% of reading + 0.025% of full scale)		
Response Time		<1 second.	
Input Resistance		Range	Approximate Resistance
		200 μA	1.0 kΩ
		2 mA	100.0 Ω
		20 mA	10.2 Ω
		200 mA	1.2 Ω
		2000 mA	0.4 Ω
Maximum Input Current		2 A any range.	
Maximum Open Circuit Input Voltage (mA to LOW)		250 V peak.	
Maximum Floating Voltage mA to ground		1000 V peak.	
LOW to ground		1000 V peak.	
Input Connectors		Front panel only.	
Maximum Resolution		10 nA.	
AC AMMETER			
Accuracy for 200 μA, 2 mA, 20 mA, 200 mA and 2000 mA ranges. 20 Hz to 10 kHz (Sinewave) +18°C to +28°C	±(0.6% of reading + 0.05% of full scale)	Input current must be between 5% and 100% of full scale.	
0°C to +18°C, +28°C to +50°C	±(0.7% of reading + 0.075% of full scale)	Usable to 20 kHz.	
Response Time		<2 seconds.	
Input Resistance		Range	Approximate Resistance
		200 μA	1.0 kΩ
		2 mA	100.0 Ω
		20 mA	10.2 Ω
		200 mA	1.2 Ω
		2000 mA	0.4 Ω

Table 1-1 (cont)

Characteristics	Performance Requirements	Supplemental Information
AC AMMETER (cont)		
Maximum Input Current		2 A any range.
Maximum Open Circuit Input Voltage (mA to LOW)		250 V peak.
Maximum Floating Voltage		
mA to ground		1000 V peak.
LOW to ground		1000 V peak
Input Connectors		Front panel only.
Maximum Resolution		10 nA
TEMPERATURE		
Accuracy for the -62°C to +240°C range.		
+18°C to +28°C ambient		
Probe calibrated to instrument	±2°C from -62°C to +150°C. +3°C to -6°C from +150°C to +240°C	
Any probe	±4°C from -62°C to +150°C. +2°C to -8°C from +150°C to +240°C.	
0°C to +18°C, +28°C to +50°C	Add 1.5°C to the above tolerance in each direction.	
Input Connectors		

Table 1-1 (cont)

ELECTRICAL CHARACTERISTICS (Rear Interface Inputs)

Characteristics	Performance Requirements	Supplemental Information
Maximum Input Voltage (dc, ac, dB, and ohms)		
Pin 28B to 28A		200 V peak. Equivalent to 43 dBV or 45.2 dBm.
Pin 28B to ground		200 V peak.
Pin 28A to ground		200 V peak.

DC VOLTMETER (REAR INTERFACE INPUTS)

Accuracy for 200 mV, 2 V, 20 V, 200 V and 1000 V ranges.		
+18°C to +28°C		
200 mV range	$\pm(0.05\% \text{ of reading} + 0.015\% \text{ of full scale})$	
2 V to 200 V range	$\pm(0.05\% \text{ of reading} + 0.01\% \text{ of full scale})$	
1000 V range	$\pm(0.05\% \text{ of reading} + 0.02\% \text{ of full scale})$	
0°C to +18°C, +28°C to +50°C		
200 mV to 200 V range	$\pm(0.1\% \text{ of reading} + 0.025\% \text{ of full scale})$	
1000 V range	$\pm(0.1\% \text{ of reading} + 0.05\% \text{ of full scale})$	

(continues on next page)

Table 1-1 (cont)

Characteristics	Performance Requirements	Supplemental Information
AC VOLTMETER (REAR INTERFACE INPUTS)		
Accuracy for 200 mV, 2 V, 20 V, 200 V and 500 V ranges. +18°C to +28°C		Input signal must be between 5% and 100% of full scale input. The 500 V range is limited to between 200 V peak and 100 V rms.
200 mV to 200 V range		
40 Hz to 10 kHz	±(1.6% of reading + 0.05% of full scale)	
20 Hz to 40 Hz and 10 kHz to 20 kHz	±(2.0% of reading + 0.05% of full scale)	
500 V range		
40 Hz to 10 kHz	±(1.6% of reading + 0.2% of full scale)	
20 Hz to 40 Hz and 10 kHz to 20 kHz	±(2.0% of reading + 0.2% of full scale)	
0°C to +18°C, +28°C to +50°C		
200 mV to 200 V range		
40 Hz to 10 kHz	±(1.8% of reading + 0.075% of full scale)	
20 Hz to 40 Hz and 10 kHz to 20 kHz	±(2.3% of reading + 0.075% of full scale)	
500 V range		
40 Hz to 10 kHz	±(1.8% of reading + 0.3% of full scale)	
20 Hz to 40 Hz and 10 kHz to 20 kHz	±(2.3% of reading + 0.3% of full scale)	

DECIBELS (dB)—TRUE RMS (REAR INTERFACE INPUTS)

Accuracy for -40 dB, -20 dB, 0 dB, +20 dB and +40 dB ranges +18°C to +28°C		
+20 dB to -15 dB	±0.6 dB 20 Hz to 20 kHz	
-15 dB to -20 dB	±0.6 dB 20 Hz to 2 kHz ±1.6 dB 2 kHz to 10 kHz	Typically <2.6 dB 10 kHz to 20 kHz
0°C to +18°C, +28°C to +50°C		
+20 dB to -15 dB	±1.2 dB 20 Hz to 20 kHz	
-15 dB to -20 dB	±1.2 dB 20 Hz to 2 kHz ±2.2 dB 2 kHz to 10 kHz	Typically <3.2 dB 10 kHz to 20 kHz

Table 1-1 (cont)

Characteristics	Performance Requirements	Supplemental Information
OHMMETER (REAR INTERFACE INPUTS)		
Accuracy for 200 Ω , 2 k Ω , 20 k Ω , 200 k Ω , 2000 k Ω , and 20 M Ω ranges +18°C to +28°C		
200 Ω to 200 k Ω LO Ω 2 k Ω to 2000 k Ω HI Ω	$\pm(0.15\%$ of reading + 0.015% of full scale) + 0.02 Ω	
2000 k Ω LO Ω	$\pm(0.3\%$ of reading + 0.015% of full scale) + 0.02 Ω	
20 M Ω HI Ω	$\pm(0.5\%$ of reading + 0.015% of full scale) + 0.02 Ω	
0°C to +18°C, +28°C to +50°C		
200 Ω to 200 k Ω LO Ω 2 k Ω to 2000 k Ω HI Ω	$\pm(0.3\%$ of reading + 0.025% of full scale) + 0.02 Ω	
2000 k Ω LO Ω 20 M Ω HI Ω	$\pm(1.2\%$ of reading + 0.025% of full scale) + 0.02 Ω	

Table 1-2
MISCELLANEOUS

Characteristics	Description
Power Consumption	Approximately 9 watts.
Reading Rate	3 1/3 per second.
Over-range Indication	Flashing display except on 500 Vac and 1000 Vdc ranges.
Calibration Interval	1000 hours of operation or 6 months, whichever occurs first.
Warm-up Time	30 minutes (60 minutes after storage in high humidity environment).

Table 1-3
ENVIRONMENTAL^a

Characteristics	Description	
Temperature		
Operating	0°C to +50°C ^b	Meets or exceeds MIL-T-28800B, class 5 with exceptions. ^d
Non-operating	-55°C to +75°C	
Humidity	95% to 100% for 5 days (derated above 25°C)	Meets or exceeds MIL-T-28800B, class 5.
Altitude		
Operating	4.6 km (15,000 ft)	Meets or exceeds MIL-T-28800B, class 3.
Non-operating	15 km (50,000 ft)	
Vibration	0.64 mm (0.025") disp. 5-55-5 Hz ^{nc} (sine wave). 75 min. total.	Meets or exceeds MIL-T-28800B, class 3.
Shock	30 g's (half sine) 11 ms 18 shocks ^{nc}	Meets or exceeds MIL-T-28800B, class 3.
Bench Handling		
Operating	45° or 4" or equilibrium ^{nc} , whichever occurs first.	Meets or exceeds MIL-T-28800B, class 3.
E.M.C.		
Operating	30 Hz to 1 GHz ^b	Meets or exceeds MIL-T-28800B, class 3.
Electrical Discharge		
Operating	20 kV max. ^b	No MIL-T-28800 equivalent. Charge applied to each protruding area of the front panel except the input connectors.
Transportation		
Vibration	25 mm (1 inch at 270 rpm for 1 hr) ^c	National Safe Transit Association Preshipment Test Procedures project: 1A-B-1 and 1A-B-2.
Package Drop	10 drops from 3 ft (91 cm) ^c	

^aSee Table 1-4 for system modifiers.

^bWith power module.

^cWithout power module.

^dTemperature: During low temperature test MIL-T-28800B paragraph 4.5.5.1.3 (b) for class 5, steps 4 and 5 shall be performed before step 2. Also, the instrument shall not be operating during step 6, paragraph 4.5.5.1.3 (e), class 5. While operating, condensed moisture shall not be present on class 5 instruments. Drying of the instrument for this class may be performed in a suitable chamber, if necessary.

Table 1-4
TM 500 SYSTEMS
ENVIRONMENTAL SPECIFICATION

Characteristics	TM 501	TM 503	TM 504	TM 506	TM 515
Temperature Operating Non-operating	Meets same test standards as plug-in.				
Humidity Operating Non-operating	Meets same test standards as plug-in.				
Altitude Operating Non-operating	Meets same test standards as plug-in.				
Vibration Operating	0.26 mm (0.010 in.) disp., 10-55 Hz (sine wave). 75 min. total.			0.38 mm (0.015 in.) disp. 10-55 Hz (sine wave) 75 min.	
Shock Operating	20 g's (1/2 sine) 11 ms, 18 shocks			30 g's (1/2 sine) 11 ms, 18 shocks.	
Bench Handling Operating	Meets same test standards as plug-in.				
Electric Discharge Operating	Meets same test standards as plug-in.				
Transportation Vibration Package Drop	Meets same test standards as plug-in.				

Table 1-5
PHYSICAL CHARACTERISTICS

Characteristics	Description
Finish	Anodized aluminum panel and chassis.
Net Weight	≈2.5 lbs (1.13 kg).
Overall Dimensions	2.633 in. (66.8 mm) W x 11.240 in. (285.3 mm) D x 4.961 in. (125.9 mm) H.

OPERATING INSTRUCTIONS

Installation and Removal Instructions

The DM 501A is calibrated and ready to use when received. It operates in one compartment of a TM 500-Series power module. Refer to the power module instruction manual for line voltage requirements and power module operation.

CAUTION

Turn the power module off before inserting or removing the DM 501A; otherwise, arcing may occur at the rear interface connectors. Arcing reduces the connectors useful life and damage may be done to the plug-in circuitry.

Check to see that the plastic barriers on the interconnecting jack of the selected power module compartment match the cut-outs in the DM 501A circuit board edge connector. If they don't match, do not insert the plug-in until proper identification is made. When the units are properly matched, align the DM 501A chassis with the upper and lower guides (see Fig. 2-1) of the selected compartment. Insert the DM 501A into the compartment and press firmly to seat the circuit board in the interconnecting jack. The LED display should be visible when the power module power switch is turned on.

To remove the DM 501A, pull the release latch (located on the lower left corner) until the interconnecting jack disengages. The DM 501A will now slide out.

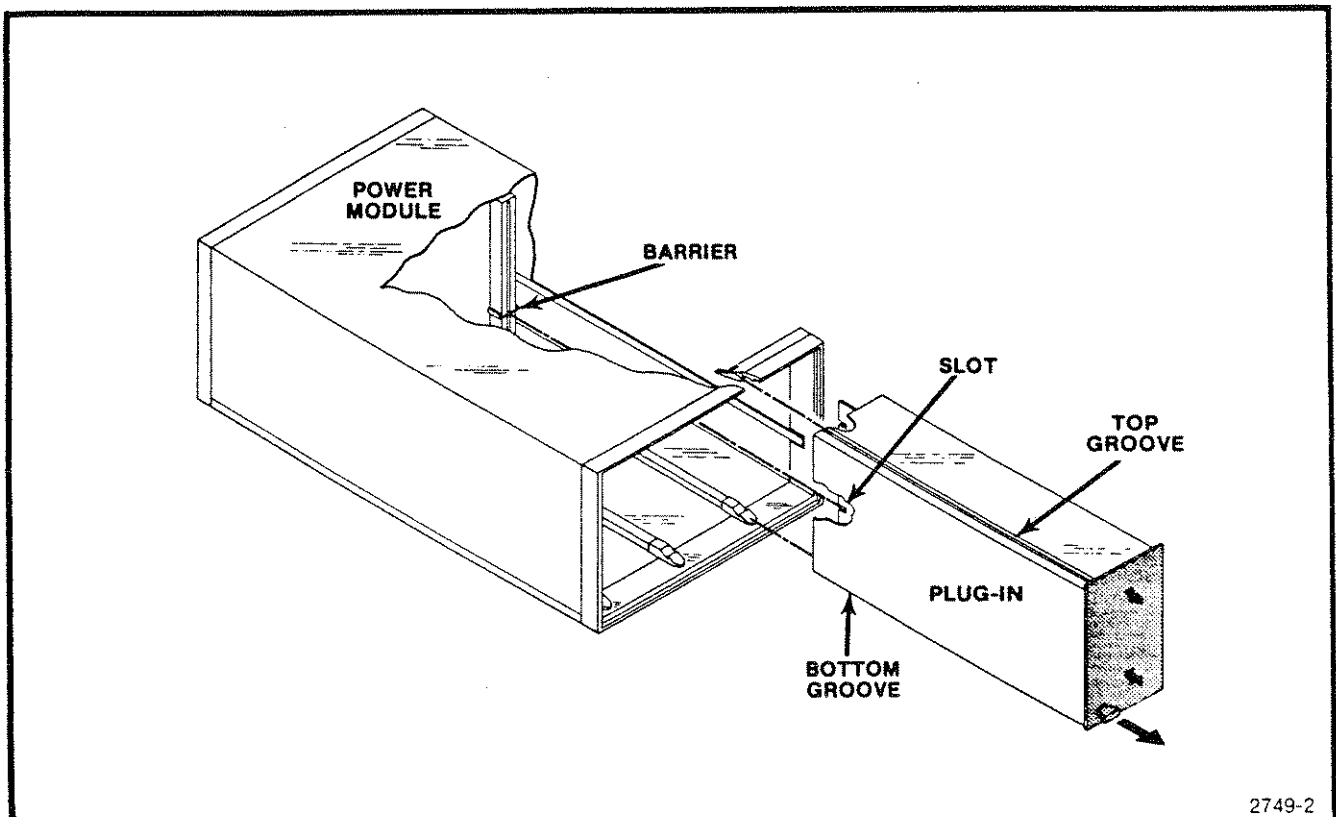



Fig. 2-1. Installation and removal.

CONTROLS AND CONNECTORS

- ① 4-1/2 digit LED readout with decimal point positioned by the selected range push button switch.
- ② Range selector push button switches for volts, ohms, current or decibel measurement.
- ③ Front-panel mA input used in conjunction with the LOW input for current measurement.
- ④ Temperature probe input connector.
- ⑤ Chassis ground binding post.
- ⑥  Front-panel inputs for volts, ohms and decibel measurements.
- ⑦ Temperature input function push button.

INPUT

- ⑧  Push button selects either rear interface inputs or front-panel inputs for measurement.

mA

- ⑨ Ac current function push button.
- ⑩ Dc current function push button.
- ⑪ Push button selects HI or LO as probe tip voltage for measuring ohms.
- ⑫ Ohms function push button.

VOLTS

- ⑬  Decibel function push button (used in conjunction with the AC volts push button).
- ⑭ Ac volts function push button.
- ⑮ Dc volts function push button.

- ⑯ Release latch. Pull to remove plug-in.



Refer to General Operating Information.

General Operating Information

With the DM 501A properly installed in the power module and the power switch on, allow thirty minutes warm-up time for operation to specified accuracy. Select the desired measurement function and range. When the value of the quantity measured is unknown, select the highest range first. Decrease the range setting until the display reads between 10% and 100% of the full-scale reading. This particular range will give maximum resolution. When an input signal causes the display to read greater than 19999, an overrange blinking display occurs. This blinking indicates the input is greater than the full-scale reading on the particular range selected.

The 1000 Vdc and 500 Vac range will not cause a blinking display when the input signal exceeds the maximum allowable input on this range.

CAUTION

Instrument damage may occur if maximum input potential is exceeded.

Input Connections



Four input connectors provide front-panel measurement connections. The VOLTS/ Ω and LOW input connectors are used for dc voltage, ac voltage, dBV, dBm and ac and dc resistance measurements. The mA and LOW input connectors are used for ac or dc current measurements. The input EXT-INT push button selects front-panel or rear interface input. Rear interface pins 28A (LO) and 28B (HI) are used for rear interface voltage, dB and resistance measurements. The TEMP input connector is used for temperature measurements.

CAUTION

To avoid equipment damage, do not apply a voltage exceeding 200 V peak between pins 28A and 28B of the rear interface connector.

Normal measurement conditions are with the LOW connector referenced to the device-under-test common. A connection between the LOW input connector and the ground terminal may be made to reference the input to the DM 501A chassis ground. Use caution as the LOW connector is connected to earth ground through the power module three-wire power cord.

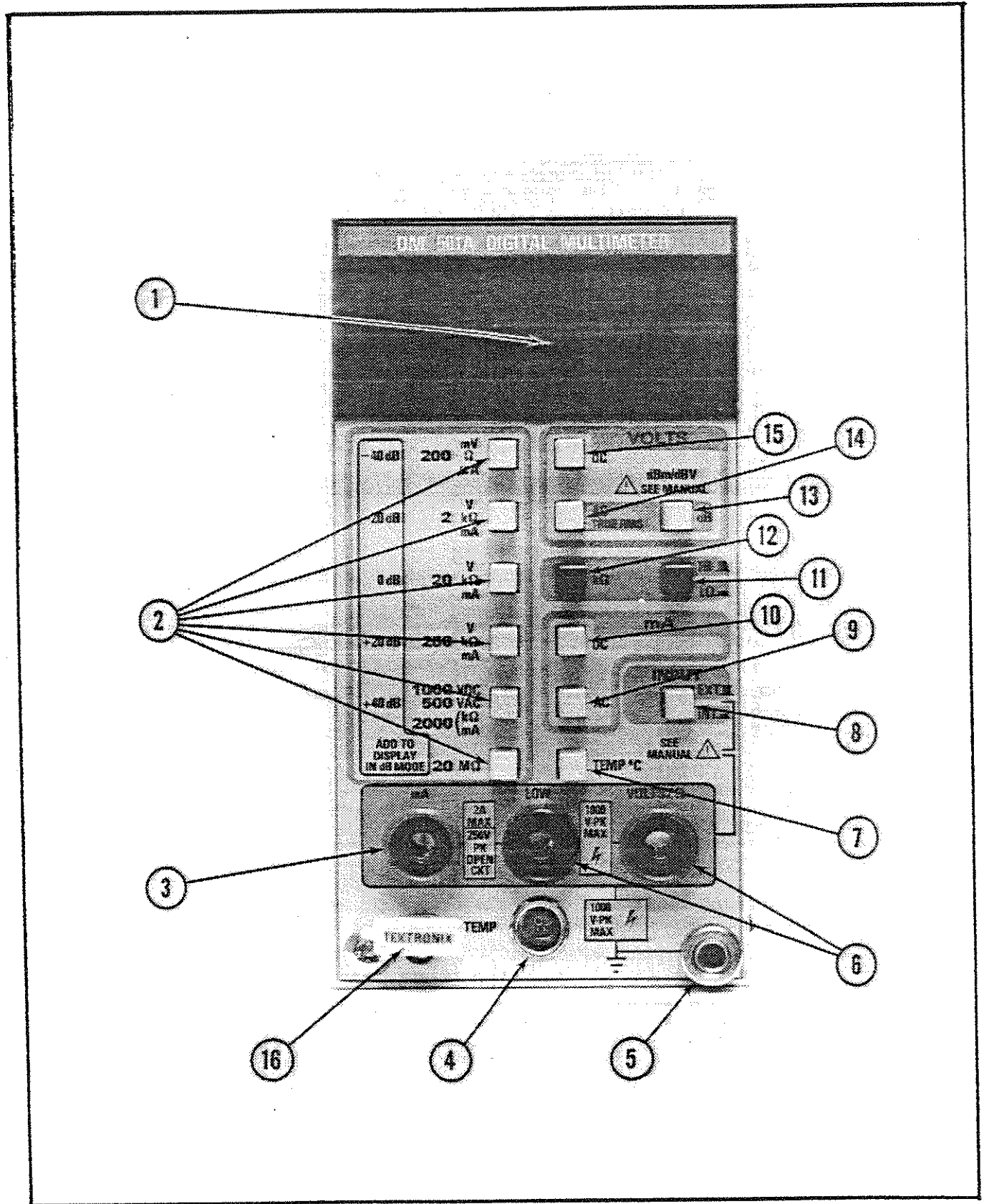

Fig. 2-2. Controls and connectors.

CAUTION

To help eliminate shock hazard from voltages measured by the DM 501A:

1. If the measured voltage exceeds 42.5 V peak, avoid all contact with the voltage source.
2. Disconnect test probes from circuit-under-test before disconnecting probes from the DM 501A, or before removing the DM 501A from the power module.

Dc Voltage Measurements

Press the VOLTS DC push button and an appropriate range button. Apply the voltage to be measured to the LOW and VOLTS/Ω input connectors. Observe the maximum input voltage ratings as indicated on the front panel. The readout displays a + reading if the input to the VOLTS/Ω connector is positive with respect to the LOW input connector. A - reading is displayed if the input at the VOLTS/Ω connector is more negative. With the LOW and VOLTS/Ω input connectors shorted, the display reads zero as to the specifications.

Dc Current Measurements

Press the mA DC push button and appropriate range button. Connect the dc current to be measured to the LOW and mA input connectors. Conventional current flowing into the mA connector and out of the LOW connector indicates a + on the display. The current input is protected with an internal fuse located on the circuit board. Refer to qualified personnel when checking this fuse.

Ac Voltage and dB Measurements

For ac voltage measurements, press the VOLTS AC push button and an appropriate range button. Connect the unknown voltage between the LOW and VOLTS/Ω input connectors. The ac voltage and dB measurements are made with an ac only calculating true rms to dc converter. Voltages can be measured with a crest factor up to four. The crest factor is the ratio of the peak voltage to rms voltage.

Press the VOLTS AC and dB push buttons with an appropriate range button. A ±20 dB dynamic range exists when any one range push button is pressed, except in the +40 dB range. The dB measurement is obtained by adding the displayed value to the selected range. For example, a -15.6 displayed reading on the -20 dB range corresponds to a -35.6 dB signal. When in the +40 dB range, the maximum displayed value must be limited to +16.2 dBm or +14 dBV because of the 500 Vac maximum rating of the instrument.

When the DM 501A is shipped, the 0 dB reference is 1 mW into 600 Ω (0.7746 V). A 0 dB reference of 1 V is also available through an internal jumper (see the Calibration Procedure).

WARNING

Refer jumper change to qualified personnel.

Ac Current Measurements

To measure ac current, press the mA push button and an appropriate range button. Connect the unknown ac current to be measured between the mA and LOW input connectors. The ac current measurements are made using an ac only calculating true rms to dc converter.

Resistance Measurements

Press the kΩ function push button and the appropriate range button. The scaling factor is a function of the range push buttons only. Select the HI or LO function push button for the maximum desired voltage at full scale (see Table 2-1). The HI function advantage is it's non-susceptibility to noise or thermocouple (dissimilar metals) generated error signals. The LO function advantage is allowing in-circuit measurements without forward biasing most silicon type semiconductor components.

The kΩ function provides constant current at the LOW and VOLTS/Ω input connectors. The conventional current flows from the VOLTS/Ω connector into the LOW connector. Refer to Table 2-1 for the value of current and maximum voltages across the input connectors for full-scale display readings (instrument not over-ranged). The maximum (open circuit) voltage available from the VOLTS/Ω connector referenced to the LOW connector in the kΩ function is approximately +6 V.

Table 2-1

OHMMETER SOURCE CURRENT AND VOLTAGE

Range Scale	Source Current		V Max at Full Scale	
	HI	LO	HI	LO
200 Ω	1 mA	1 mA	0.2 V	0.2 V
2 kΩ	1 mA	100 μA	2.0 V	0.2 V
20 kΩ	100 μA	10 μA	2.0 V	0.2 V
200 kΩ	10 μA	1 μA	2.0 V	0.2 V
2000 kΩ	1 μA	0.1 μA	2.0 V	0.2 V
20 MΩ	0.1 mA	0.1 μA	2.0 V	2.0 V

Temperature Measurements

Connect the P6601 temperature probe to the front-panel TEMP connector. Use care to align the connector pins. Press the TEMP °C push button. Apply the probe sensor tip to the device-under-test (DUT). Allow sufficient time for the probe tip to stabilize before taking a reading. The time to reach a stable reading is a function of the thermal mass of the probe and DUT, the thermal resistance of the probe and DUT, and the amount of heat being applied to the DUT.

Refer to the P6601 manual for more information on temperature measurements and probe use.

A list of standard accessories (and part numbers) is located in the Replaceable Mechanical Parts list.

Repackaging Information

If this Tektronix instrument is to be shipped to a Tektronix Service Center for service or repair, attach a tag showing owner (with address) and the name of an

individual at your firm that can be contacted. Include the complete instrument serial number and a description of the service required.

Save and re-use the package in which the instrument was shipped. If the original packaging is unfit for use or not available, repackage the instrument as follows:

Surround the instrument with polyethylene sheeting to protect the finish of the instrument. Obtain a carton of corrugated cardboard of the correct carton strength and having inside dimensions of no less than 6 inches more than the instrument dimensions. Cushion the instrument by tightly packing 3 inches of dunnage or urethane foam between carton and instrument on all sides. Seal the carton with shipping tape or an industrial stapler.

The carton test strength for this instrument is 200 pounds per square inch.

INSTRUCTIONS D'UTILISATION

Instructions d'installation et de démontage

Le multimètre numérique DM 501A est livré étalonné et prêt à fonctionner. Il peut être utilisé dans n'importe quel boîtier d'alimentation de la série TM 500 (se reporter au manuel d'instructions du châssis d'alimentation pour toute information relative à la mise sous tension de l'appareil).

ATTENTION

Couper l'alimentation du châssis avant d'insérer ou d'extraire le DM 501A (des arcs électriques pourraient se produire au niveau du connecteur, diminuer sa durée de vie et endommager les circuits du tiroir).

Vérifier que les détrompeurs situés sur le connecteur du châssis d'alimentation choisi s'adaptent aux encoches situées sur le connecteur arrière du circuit imprimé du DM 501A. L'insertion du tiroir ne peut se faire qu'à partir du moment où les détrompeurs sont correctement placés. Aligner ensuite les rainures supérieure et inférieure du DM 501A avec les guides du châssis d'alimentation (voir Fig. 2-1) et insérer à fond le tiroir. L'affichage doit apparaître dès la mise sous tension.

Pour extraire le DM 501, tirer le loquet de verrouillage (situé au coin inférieur gauche) jusqu'à ce que le connecteur arrière soit libéré. Faire ensuite glisser l'appareil.

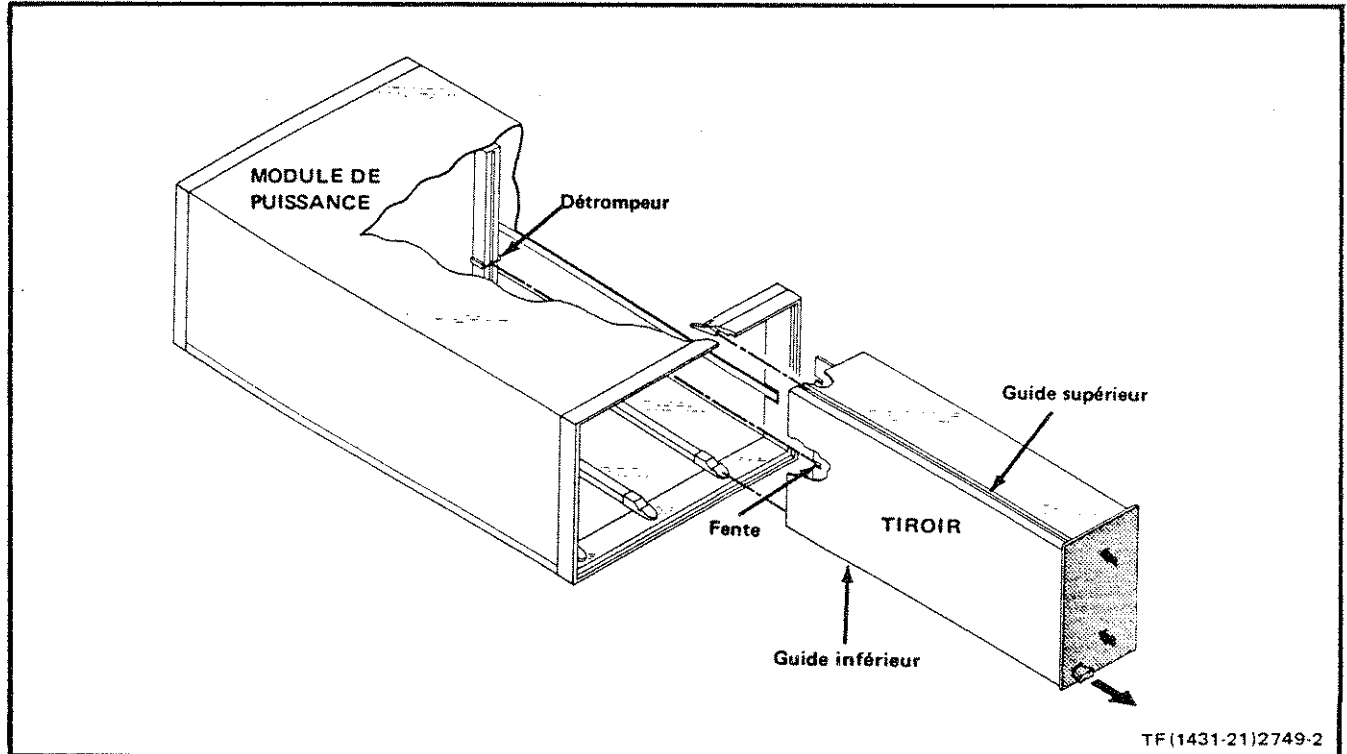



Fig. 2-1. Installation et démontage.

COMMANDES ET PRISES

- ① Affichage à 4 chiffres 1/2, réalisé par diodes électroluminescentes. L'emplacement de la virgule est déterminé par la gamme sélectionnée.
- ② Commandes de sélection de gammes pour les mesures de tension (volts), résistance (ohms), courant (ampères) ou niveaux (décibels).
- ③ Prise d'entrée mA située sur le panneau avant, utilisée conjointement avec l'entrée LOW pour les mesures de courant.
- ④ Prise d'entrée de la sonde de température.
- ⑤ Borne de mise à la masse du châssis.
- ⑥  Entrées situées sur le panneau avant pour effectuer des mesures de tension (volts), résistance (ohms) et niveaux (décibels).
- ⑦ Bouton de commande de la fonction « Mesure de température ».

INPUT (entrée)

- ⑧  Bouton poussoir sélectionnant soit les entrées au niveau du connecteur arrière, soit les entrées situées sur le panneau avant.

mA

- ⑨ Bouton de commande de la fonction « Mesure de courant alternatif ».
- ⑩ Bouton de commande de la fonction « Mesure de courant continu ».
- ⑪ Bouton poussoir sélectionnant les niveaux haute tension (HI) ou basse tension (LO) à l'embout de la sonde pour les mesures de résistance (ohms).
- ⑫ Bouton de commande de la fonction « Mesure de résistance ».

VOLTS

- ⑬  Bouton de commande de la fonction « Mesure de niveaux (décibels), utilisé conjointement avec le bouton poussoir de mesure de tension alternative.
- ⑭ Bouton de commande de la fonction « Mesure de tension alternative ».
- ⑮ Bouton de commande de la fonction « Mesure de tension continue ».
- ⑯ Loquet de verrouillage. Tirer pour extraire le tiroir.



Se reporter aux informations générales sur l'utilisation.

Informations générales sur l'utilisation

Le DM 501A étant correctement mis en place et le module d'alimentation placé sous tension, prévoir un temps de mise en chauffe de 30 minutes pour obtenir la précision annoncée. Sélectionner ensuite la nature de la mesure désirée et la gamme. Lorsque la valeur de la quantité mesurée est inconnue, sélectionner au départ la plus haute gamme. Choisir ensuite une gamme plus basse jusqu'à ce que l'affichage soit compris entre 10 % et 100 % de la pleine échelle. On obtient ainsi une résolution maximale. Si un signal d'entrée provoque un affichage supérieur à 19999, c'est-à-dire supérieur à l'affichage à pleine échelle de la gamme sélectionnée, l'affichage clignote indiquant ainsi qu'il y a dépassement de la capacité d'affichage de la gamme considérée.

La gamme de 1000 V continu et 500 V alternatif ne provoque aucun clignotement de l'affichage si le signal d'entrée excède la tension maximale autorisée dans cette gamme.

ATTENTION

L'instrument peut être endommagé si le potentiel appliqué est supérieur à la tension d'entrée maximale autorisée.

Connexions d'entrée

Les connexions du panneau avant sont composées de quatre prises d'entrée. Les prises d'entrée VOLTS/OHMS et LOW sont utilisées pour les mesures de tension continue, tension alternative, mesures de niveaux dBV, dBm et mesures de résistance alternative et continue. Les prises d'entrée mA et LOW sont utilisées pour les mesures de courant alternatif ou continu. Le bouton poussoir EXT/INT sélectionne l'entrée au niveau de l'interface arrière ou du panneau avant. Les broches 28A (LO) et 28B (HI) de l'interface arrière sont utilisées pour les mesures de tension, de niveau (dB) et de résistance au niveau de l'interface arrière. La prise d'entrée TEMP est utilisée pour les mesures de température.

ATTENTION

Afin d'éviter tout endommagement du tiroir, ne pas appliquer de tension excédant 200 V crête entre les broches 28A et 28B du connecteur arrière.

Lors de mesures classiques, la borne d'entrée LOW est reliée au commun du circuit sous test. Une connexion peut être établie entre la prise d'entrée LOW et la borne de masse afin de référencer l'entrée du DM 501A au châssis de l'appareil. Des précautions sont à prendre lorsque la borne LOW est ainsi reliée à la terre, au moyen du câble d'alimentation réseau à trois conducteurs.

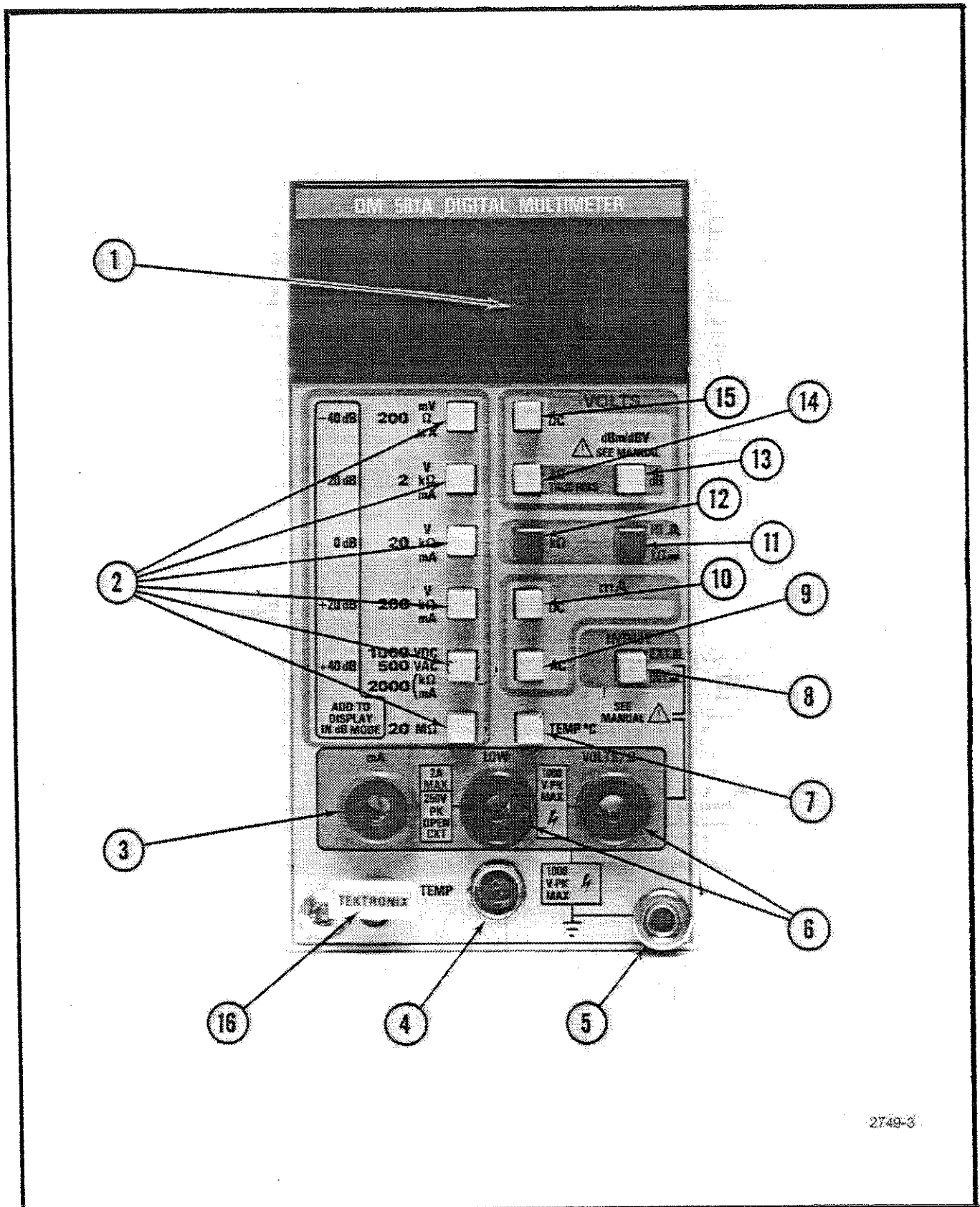

2749-3

Fig. 2-2. Commandes et prises

ATTENTION

Pour éliminer au mieux les risques éventuels d'électrocution :

1. Éviter tout contact avec la source de tension si la tension mesurée dépasse 42,5 V crête.
2. Déconnecter les sondes du circuit sous test avant de les déconnecter du DM 501A ou avant d'extraire le DM 501A de son module d'alimentation.

Mesures de tension continue

Appuyer sur le bouton poussoir VOLTS DC et sélectionner la gamme appropriée. Appliquer la tension à mesurer sur les prises d'entrée LOW et VOLT/ohm. S'assurer que la tension d'entrée maximale indiquée sur le panneau avant n'est pas dépassée. L'affichage indiquera un + si l'entrée de la prise VOLTS/ohm est positive par rapport à l'entrée LOW et un - dans le cas contraire. Si les entrées VOLTS/OHM et LOW sont réunies entre elles (court circuit), l'affichage doit indiquer «0».

Mesures de courant continu

Appuyer sur le bouton poussoir mA DC et sélectionner la gamme appropriée. Faire circuler le courant continu à mesurer entre les prises d'entrée LOW et mA. L'affichage indiquera un + si le courant entre la borne mA et sort par la borne LOW (sens conventionnel du courant). Un fusible interne situé sur le circuit imprimé protège l'entrée du courant. Seule une personne qualifiée peut procéder à la vérification de ce fusible.

Mesures de tension alternative et mesures de niveaux (décibels)

Pour effectuer les mesures de tension alternative, appuyer sur le bouton poussoir VOLTS AC et sélectionner la gamme appropriée. Appliquer la tension inconnue aux prises d'entrée LOW et VOLTS/OHM. Les mesures de tension alternative ou de niveaux (dB) s'effectuent grâce à un convertisseur tension efficace calculée/tension continue. Les tensions peuvent être mesurées avec un facteur de crête allant jusqu'à quatre. Le facteur de crête est le rapport de la tension crête sur la tension efficace.

Appuyer sur les boutons poussoirs VOLTS AC et dB et sélectionner la gamme appropriée. On obtient une dynamique de ± 20 dB sur n'importe quelle gamme exception faite de la gamme +40 dB. Les mesures de niveaux (dB) s'effectuent en additionnant la valeur affichée au nombre de dB indiqué par la gamme sélectionnée. Par exemple, supposons que la valeur affichée soit -15,6 dB sur une gamme de -20 dB. La valeur du signal sera alors de -35,6 dB. Sur la gamme de +40 dB, la valeur maximale affichée sera limitée à +16,2 dBm ou +14 dBV, la tension alternative maximale applicable à l'appareil étant de 500 V.

A la livraison de l'appareil, la valeur de référence 0 dB est d'un mW dissipé dans une résistance de 600 Ω (0,7746 V). La valeur de référence, en dBV, d'un volt est également disponible par l'intermédiaire d'un cavalier interne (voir la procédure d'étalonnage).

AVERTISSEMENT

Seul un personnel qualifié peut procéder au changement du cavalier.

Pour effectuer des mesures de courant alternatif, appuyer sur le bouton poussoir mA et sélectionner la gamme convenable. Appliquer le courant alternatif inconnu à mesurer aux prises d'entrée mA et LOW. Les mesures de courant alternatif s'effectuent grâce à un convertisseur tension efficace calculée/tension continue.

Mesures de résistance

Appuyer sur le bouton poussoir kΩ et sélectionner la gamme adéquate. Le facteur d'échelle est fonction de la gamme sélectionnée. Pour obtenir la tension maximale possible à pleine échelle (voir tableau 2-1) sélectionner par l'intermédiaire du bouton poussoir la tension haute (HI) ou la tension basse (LO). L'avantage de la fonction HI réside dans son insensibilité au bruit et à l'effet de thermocouple (dû à la présence de métaux différents) susceptibles de générer des erreurs. La fonction LO offre la possibilité d'effectuer des mesures de résistance dans les circuits sans créer de polarisation directe de la plupart des semi-conducteurs au silicium.

La fonction kΩ permet la circulation d'un courant constant entre les prises d'entrée LOW et VOLTS/kΩ. Le courant conventionnel circule de la prise VOLTS/Ω vers la prise LOW. Le tableau 2-1 indique les valeurs courant et des tensions maximales appliquées aux prises d'entrée pour une lecture à pleine échelle (sans dépassement de capacité). La tension maximale disponible (circuit ouvert) sur la prise VOLTS/Ω par rapport à la prise LOW dans la fonction kΩ est d'environ +6 V.

Tableau 2-1

Gamme	Courant de mesure		Tension maximale à pleine échelle	
	Tension haute	Tension basse	Tension haute	Tension basse
200 Ω	1 mA	1 mA	0.2 V	0.2 V
2 kΩ	1 mA	100 μA	2.0 V	0.2 V
20 kΩ	100 μA	10 μA	2.0 V	0.2 V
200 kΩ	10 μA	1 μA	2.0 V	0.2 V
2000 kΩ	1 μA	0.1 μA	2.0 V	0.2 V
20 MΩ	0.1 mA	0.1 μA	2.0 V	2.0 V

Mesures de température

Connecter la sonde P6601 à la prise TEMP du panneau avant. Procéder, avec soin, à l'alignement des broches du connecteur. Appuyer sur le bouton poussoir TEMP °C. Appliquer l'extrémité sensible de la sonde au composant sous test. Attendre suffisamment pour que la température de l'embout de la sonde se soit stabilisée avant d'effectuer une mesure. Le temps nécessaire à la stabilisation de la lecture dépend de plusieurs facteurs : la masse thermique de la sonde et du composant sous test, la résistance thermique de la sonde et du composant sous test et la quantité de chaleur appliquée au composant sous test.

Se reporter au manuel de la sonde P6601 pour avoir des informations complémentaires sur les mesures de température et l'utilisation de la sonde.

La liste des accessoires standard (avec leur référence) se trouve dans la liste des pièces mécaniques du manuel.

Instructions de réemballage pour expédition

Si un appareil Tektronix doit être expédié à un centre de maintenance Tektronix, pour entretien ou réparation, attachez à l'appareil une étiquette portant les indications

suivantes : nom du propriétaire, l'adresse complète et le nom du responsable pouvant être contacté. Ne pas oublier de mentionner le type complet de l'instrument, le numéro de série et une description de l'intervention souhaitée.

Nous vous recommandons de conserver le carton et le matériel d'emballage d'origine dans lequel vous avez reçu votre appareil. Si vous n'avez pas préservé ceux-ci, emballez l'instrument de la manière suivante :

- . Procurez-vous une boîte de carton ondulé dépassant d'au moins 15 cm les dimensions de l'appareil de manière à pouvoir entourer celui-ci de matériaux protecteurs.
- . Entourez l'instrument d'une feuille de polyéthylène de manière à assurer la protection du boîtier.
- . Intercalez entre le carton et l'instrument de la mousse d'uréthane, d'une épaisseur de 7,6 cm de chaque côté.
- . Fermez le carton au moyen d'une bande adhésive ou d'une grosse agrafeuse industrielle.

Test de résistance de l'emballage pour cet appareil : 15 kg/cm².

1
2
3
4
5
6
7
8
9
10
11
12
13
14
15
16
17
18
19
20
21
22
23
24
25
26
27
28
29
30
31
32
33
34
35
36
37
38
39
40
41
42
43
44
45
46
47
48
49
50
51
52
53
54
55
56
57
58
59
60
61
62
63
64
65
66
67
68
69
70
71
72
73
74
75
76
77
78
79
80
81
82
83
84
85
86
87
88
89
90
91
92
93
94
95
96
97
98
99
100

C

C

C

BEDIENUNGSANLEITUNG

Ein- und Ausbauanweisungen

Das DM 501A wird kalibriert und gebrauchsfertig geliefert. Es muß zur Anwendung in ein Einschubfach einer TM 500 Versorgungseinheit eingesetzt werden. Für die Bedienung und richtige Stromversorgung der Versorgungseinheit beziehen Sie sich bitte auf die Bedienungsanleitung Ihrer TM 500 Versorgungseinheit.



Vor dem Einsetzen oder Herausnehmen des DM 501A ist die Versorgungseinheit unbedingt auszuschalten, um an den rückseitigen Kontaktleisten Funkenbildung zu vermeiden, die die Funktionsdauer der Kontakte einschränken würde und evtl. Schaltkreise im Gerät beschädigen könnte.

Überprüfen Sie, ob der Plastiksteg der Verbindungsbuchse im Fach der Versorgungseinheit mit dem Ausschnitt in der Steckverbindungsleiste der DM 501A-Platine übereinstimmt. Setzen Sie den Einschub nicht ein, bevor das überprüft wurde. Bei Übereinstimmung setzen Sie das DM 501A Chassis in die obere und untere Führung (siehe Abb. 2-1) des gewählten Faches, und schieben es mit dem nötigen Druck so weit ein, bis die rückseitige Steckverbindungsleiste einrastet. Nach Einschalten der Versorgungseinheit sollte das LED-Display aufleuchten.

Zum Herausnehmen des DM 501A ziehen Sie die Entriegelungsklinke an der linken unteren Ecke des Einschubes, bis sich die rückseitige Steckverbindung löst. Nun kann das DM 501A dem Fach entnommen werden.





Bild 2-1. Ein- und Ausbau.

BEDIENUNGSELEMENTE UND STECKVERBINDUNGEN

- ① 4 1/2 stellige LED-Anzeige mit Dezimalpunkt, abhängig vom gewählten Bereich.
- ② Bereichswahl-Drucktasten für Messungen von Spannung, Widerstand, Strom und Dezibel.
- ③ Frontseitiger mA-Eingang in Verbindung mit dem LOW-Eingang für Strommessungen.
- ④ Eingangsbuchse für Temperaturtastkopf.
- ⑤ Chassis-Masseanschluß.
- ⑥  Frontseitige Eingänge für Spannungs-, Widerstands- und Dezibel-Messungen.
- ⑦ Drucktaste zur Aktivierung des Temperatureingangs.

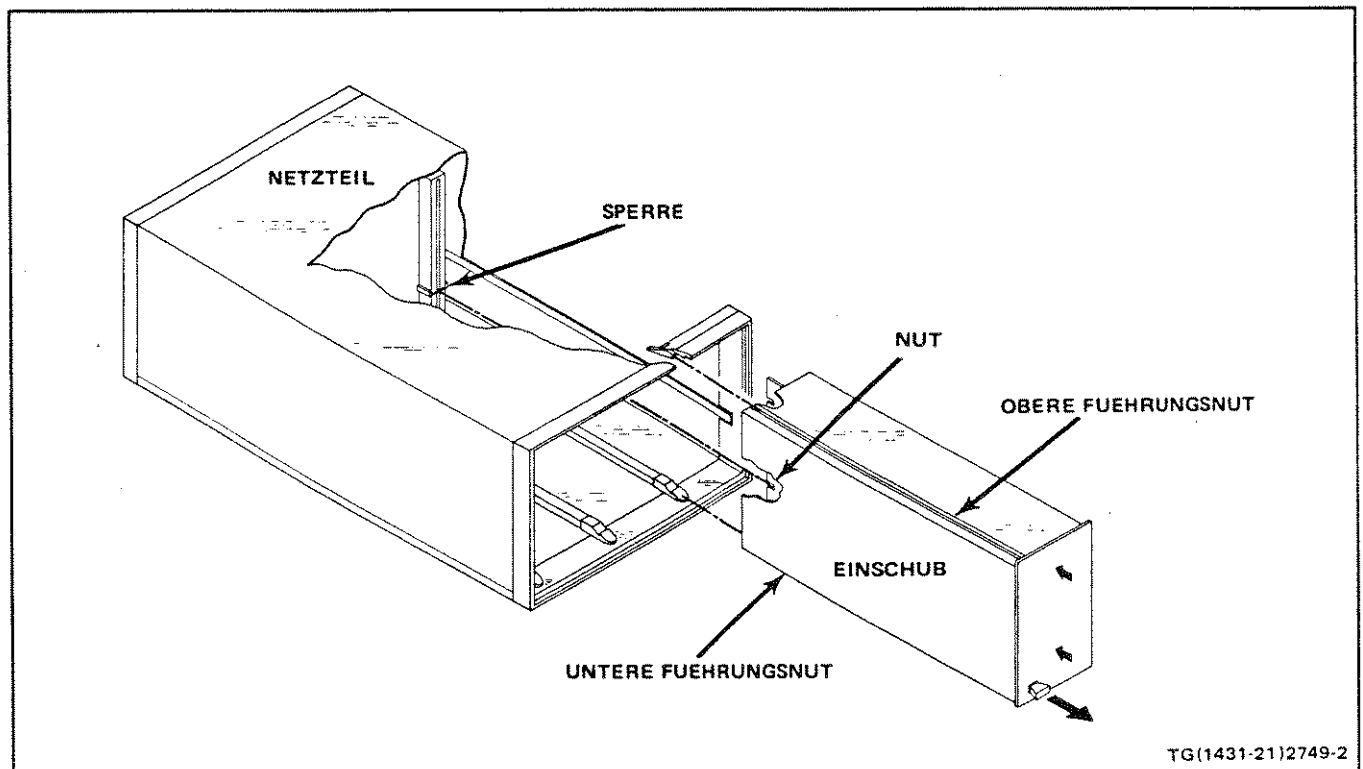

INPUT (Eingang)

- ⑧  Drucktaste zur Wahl der rückseitigen Interface-Eingänge oder der frontseitigen Meß-Eingänge

mA

- ⑨ Drucktaste für Wechselstrom (AC)-Meßbereich.
- ⑩ Drucktaste für Gleichstrom (DC)-Meßbereich.
- ⑪ Drucktaste für HI- oder LO-Betrieb bei Widerstandsmessungen.
- ⑫ Drucktaste für Widerstandsmessung.

VOLT

- ⑬  Drucktaste für den Dezibelmeßbereich. in Verbindung mit der Drucktaste für den Wechselspannungsmeßbereich (AC Volts).
- ⑭ Drucktaste für den Wechselspannungsmeßbereich (AC Volts).
- ⑮ Drucktaste für den Gleichspannungsmeßbereich (DC Volts).
- ⑯ Entriegelungsklinke zum Entnehmen des Einschubes.
-  Beziehen Sie sich auf die allgemeine Bedienungsanleitung.

Allgemeine Bedienungsanleitung

Das ist eine Versorgungseinheit eingesetzte DM 501A gestattet – nach einer Warmlaufzeit von 30 Minuten – Messungen mit der spezifizierten Genauigkeit. Hierzu ist die gewünschte Meßfunktion und der Bereich zu wählen. Ist der Meßwert unbekannt, muß zunächst der höchste Meßbereich gewählt werden. Der Meßbereich ist zu verkleinern, bis der Meßbereich zwischen 10% und 100% der Maximalanzeige liegt.

In diesem Meßbereich liegt die höchste Auflösung vor. Bei Anliegen eines Signals – was eine Anzeige von mehr als 19999 bewirkt – entsteht zum Erkennen des Überlaufs ein Blinken. Das Blinken zeigt also an, daß das Eingangssignal größer ist, als der gewählte Meßbereich.

Im 1000 V Gleichspannungs- und im 500 V Wechselspannungsbereich erfolgt bei Bereichsüberschreitung kein Blinken der Anzeige.

VORSICHT

Eine Zerstörung des Meßgerätes kann durch Überschreiten des maximal zulässigen Eingangssignals erfolgen!

Eingangs-Verbindungen

Über vier Eingänge können von der Frontseite her Meß-Signale eingespeist werden. Der Volt/Ohm und LOW-Eingang dient zur Messung von Gleichspannung, Wechselspannung, dBV, dBm und Widerstand. Der mA- und LOW-Eingang dient Gleichstrom- und Wechselstrommessungen. Über die Drucktaste EXT-INT werden die frontseitigen Eingänge oder die rückseitigen Interfaceingänge gewählt. Die rückseitigen Anschlußstifte 28A (LO) und 28B (HI) werden zur Messung von Spannung, dB und Widerstand verwendet. Der TEMP-Eingang steht für Temperaturmessungen zur Verfügung.

VORSICHT

Um eine Beschädigung der Anlage zu vermeiden, darf die Spannung an den Stiften 28A und 28B der rückseitigen Interfaceverbindungen max. 200 Vs betragen.

Unter üblichen Meßbedingungen liegt der LOW-Eingang, auf dem Massepotential des Meßobjektes. Um die Chassismasse des DM 501A auf Massepotential zu legen, kann der LOW-Eingang mit der Gerätemasse verbunden werden. Es ist dabei zu beachten, daß der LOW-Eingang dann über das 3-adrige Anschlußkabel mit Erdpotential verbunden ist.

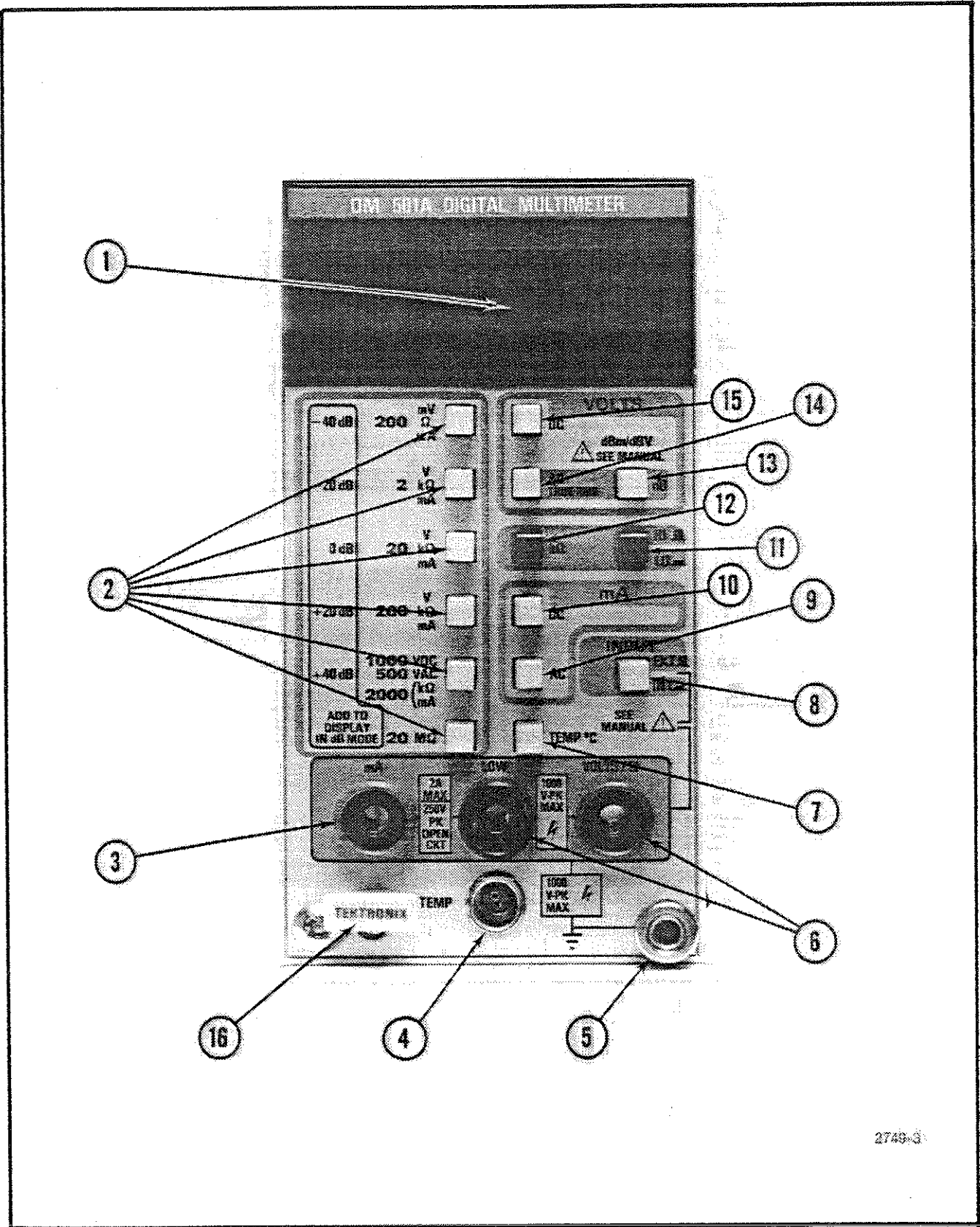

2749-3

Bild 2-2. Bedienungselemente und Stecker.

VORSICHT

Vermeidung von elektrischen Stromschlägen beim Umgang mit dem DM 501A.

1. Beträgt die zu messende Spannung mehr als 42,5 Vs, ist die Berührung spannungsführender Leiter zu vermeiden.
2. Vor dem Abklemmen der Meßleitungen am DM 501A und vor dem Herausnehmen des DM 501A aus der Versorgungseinheit, sind die Meßleitungen von der zu messenden Spannungsquelle zu trennen.

Gleichspannungsmessungen

Betätigen Sie die Drucktaste VOLTS DC (Gleichspannung) und eine entsprechende Bereichstaste. Die zu messende Spannung ist an die Eingangsbuchsen LOW und VOLTS/Ω zu legen, wobei die maximal zulässige Spannung, wie auf der Frontplatte bezeichnet, nicht überschritten werden darf. Das Display zeigt ein + Zeichen an, wenn der positive Pol der zu messenden Spannung an der Eingangsbuchse VOLTS/Ω und der negative Pol an LOW liegt. Im umgekehrten Fall erscheint im Display ein – Zeichen.

Bei kurzgeschlossenen Eingangsbuchsen zeigt das Display Null an.

Gleichstrommessungen

Betätigen Sie die Drucktaste mA DC (Gleichstrom) und eine entsprechende Bereichstaste. Der zu messende Strom ist über die Eingangsbuchsen LOW und mA zu führen. Die konventionelle Stromrichtung in die Buchse mA hinein und aus der Buchse LOW heraus, bewirkt ein + Zeichen im Display. Ein Schutz des Stromeingangs erfolgt durch eine Sicherung auf der Druckplatte im DM 501A.

Eine Überprüfung der Sicherung sollte nur von geschultem Personal vorgenommen werden.

Wechselspannungs- und dB-Messungen

Für Wechselspannungsmessungen ist die Drucktaste VOLTS AC (Wechselspannung) und eine entsprechende Bereichstaste zu betätigen.

Die zu messende Spannung ist an die Eingangsbuchsen LOW und VOLTS/Ω zu legen. Die Wechselspannungs- und dB-Messungen erfolgen mit Hilfe eines Wechselspannungs-Echtheffektiv/Gleichspannungskonverters,

wobei bis zu einem Crestfaktor von 4 gemessen werden kann. Der Crestfaktor ist definiert als das Verhältnis von Spitzenspannung zu Effektivspannung.

Betätigen Sie die Drucktasten VOLTS AC und dB, sowie eine entsprechende Bereichstaste. In jedem der mit den Drucktasten gewählten Bereiche – bis auf die +40 dB Bereichstaste – liegt ein Dynamikumfang von ±20 dB vor. Die dB-Messung erfolgt durch Addition des im Display angezeigten Wertes mit dem des gewählten dB-Bereichs;

z. B. ein angezeigter Wert von –15,6 mit einem gewählten Bereich von –20 dB ergibt ein Meßsignal von –35,6 dB. Im +40 dB Bereich ist der maximal zulässige Wert im Display +16,2 dBm oder +14 dBV aufgrund der maximal zulässigen Wechselspannung von 500 V. Bei Lieferung des DM 501A beträgt die 0 dB-Referenz 1 mW an 600 Ω (0,7746 V). Eine Umstellung auf 0 dB bei 1 V ist durch eine interne Brücke möglich (siehe hierzu die Kalibrieranweisung).

WARNUNG

Die Umstellung sollte nur von geschultem Personal durchgeführt werden.

Für Wechselstrommessungen ist die Drucktaste mA und eine entsprechende Bereichstaste zu betätigen. Der zu messende Strom ist über die Eingangsbuchsen mA und LOW zu führen.

Die Wechselstrommessungen erfolgen mit Hilfe eines Wechselstrom-Echtheffektiv/Gleichspannungskonverters.

Widerstandsmessungen

Betätigen Sie die Drucktaste kΩ und eine entsprechende Bereichstaste. Dann wählen Sie entsprechend der maximal gewünschten Meßspannung die Drucktasten HI oder LO (siehe Tabelle 2–1). Der Vorteil des HI-Betriebes ist die Unempfindlichkeit gegen Störspannungen wie sie z. B. durch Thermoelementbildung bei ungleichen Metallen entstehen können. Beim LO-Betrieb liegt die Meßspannung unterhalb der Schwellspannung von Siliziumhalbleitern, so daß ohne Einfluß innerhalb halbleiterbestückter Schaltungen gemessen werden kann.

Im Widerstandsmeßbetrieb liefern die Eingangsbuchsen LOW und VOLTS/Ω konstanten Strom mit Stromrichtung von der VOLTS/Ω Buchse in die LOW-Buchse. In Tabelle 2–1 sind die Strom- und Spannungswerte an den Eingangsbuchsen bei Bereichsendwert im Display aufgeführt. Die maximal an den Buchsen LOW und VOLTS/Ω verfügbare Leerlaufspannung beträgt +6 V.

Tabelle 2-1
Ohmmeter-Strom und -Spannung

Meßbereich	Meßstrom		max. Meßspannung bei Bereichs-Endwert	
	HI	LO	HI	LO
200 Ω	1 mA	1 mA	0,2 V	0,2 V
2 kΩ	1 mA	100 µA	2,0 V	0,2 V
20 kΩ	100 µA	10 µA	2,0 V	0,2 V
200 kΩ	10 µA	1 µA	2,0 V	0,2 V
2000 kΩ	1 µA	0,1 µA	2,0 V	0,2 V
20 MΩ	0,1 mA	0,1 µA	2,0 V	2,0 V

Temperaturmessungen

Schließen Sie den Temperaturtastkopf P 6601 an die Eingangsbuchse TEMP an, wobei auf richtige Ausrichtung der Steckerstifte geachtet werden muß. Betätigen Sie die Drucktaste TEMP °C und legen Sie die Tastkopfspitze an das Meßobjekt. Vor der Meßwertfeststellung ist eine ausreichende Zeit zur Wertstabilisierung zuzulassen. Diese Zeit ist abhängig von der thermischen Masse und dem Wärmewiderstand des Temperaturtastkopfes und des Meßobjektes sowie von der Temperatur des Meßobjektes. Detaillierte Angaben über Temperaturmessungen und die Anwendung des Temperaturtast-

kopfes entnehmen Sie bitte dem Handbuch des P 6601. Eine Aufstellung über das Standardzubehör (und Bestell-Nr.) befindet sich bei der Stückliste der mechanischen Bauteile.

Verpackungshinweise

Sollte dieses Tektronix-Meßgerät einmal an eine Tektronix-Servicestelle geschickt werden, so legen Sie dem Gerät einen Anhänger mit Namen und Adresse des Besitzers, der Geräte-Serien-Nr. und der gewünschten Serviceleistung bei.

Bewahren Sie die Originalverpackung des Gerätes für evtl. Wiederverwendung auf. Steht diese nicht mehr zur Verfügung, verfahren Sie bitte wie folgt:

Das Gerät ist zum Schutz seines Äußeren mit Plastikfolie zu umwickeln und in einen Karton aus Wellpappe mit genügender Festigkeit zu setzen. Die Innenmaße dieses Kartons sollten ca. 15 cm größer sein als die Geräteabmessungen. Polstern Sie das Gerät allseitig mit Styroporflocken oder Schaum. Der Karton ist außen mit Verpackungsband zu umwickeln.

Die Festigkeit des Originalkartons beträgt ca. 14 kg/cm².

1
2
3
4
5
6
7
8
9
10
11
12
13
14
15
16
17
18
19
20
21
22
23
24
25
26
27
28
29
30
31
32
33
34
35
36
37
38
39
40
41
42
43
44
45
46
47
48
49
50
51
52
53
54
55
56
57
58
59
60
61
62
63
64
65
66
67
68
69
70
71
72
73
74
75
76
77
78
79
80
81
82
83
84
85
86
87
88
89
90
91
92
93
94
95
96
97
98
99
100

C

C

C

取扱説明

取付および取はずし方法

DM501A型はTM500シリーズの本体に組込んで使用します。出荷時に校正されていますのですぐに使用できます。電源電圧については本体の取扱説明書をご覧ください。

注意

DM501A型を抜き差しする場合には本体の電源を切ってから行なって下さい。切らずに抜き差ししますと後部のインターフェイス・コネクタにアークが生じ、コネクタの寿命を縮めるばかりでなく、中の回路にも悪影響を与えます。

本体のコネクタ内に入っているプラスチックの位置決めスペーサとDM501A型のエッジ・コネクタのカット部分とが一致していることを確認します。差し込もうとする本体のコンパートメントの上下のガイド（2-1図）に沿ってDM501A型を押し込み、さらに本体のコネクタにDM501A型のエッジ・コネクタがしっかりと固定されるまで押して下さい。本体の電源をオンにしますとLEDが点灯します。DM501A型を取りはずす場合には、左下隅にあるつまみを引っぱりそのまま引き抜きます。

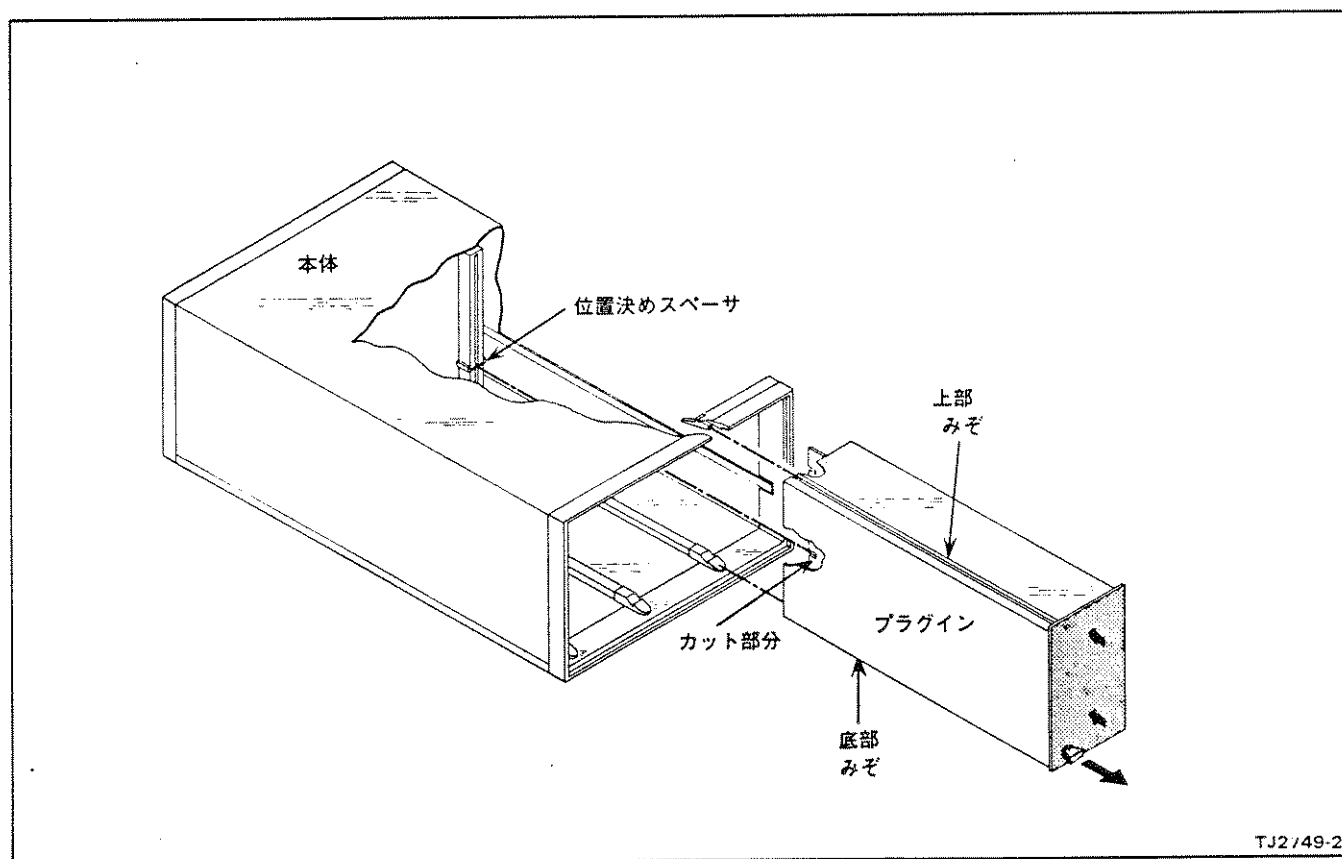

TJ2/49-2

2-1図 取付および取はずし方法

コントロールとコネクタ (2-2 図)

- ① 4桁のLED表示、小数点は押しボタン・スイッチでレンジを切換えると自動的に移動します。
- ② 電圧、抵抗、電流、dB測定のリレンジ切替用押しボタン・スイッチです。
- ③ 電流測定用入力端子でLOW入力と共に使用します。
- ④ 温度プローブ用入力コネクタです。
- ⑤ 接地用端子です。
- ⑥  電圧・抵抗・dB測定用入力端子です。
- ⑦ 温度測定用押しボタン・スイッチです。



INPUT

- ⑧  後部インターフェイス入力、前面パネル入力のどちらを測定するか選択する押しボタン・スイッチです。

mA

- ⑨ AC電流測定用押しボタン・スイッチです。
- ⑩ DC電流測定用押しボタン・スイッチです。
- ⑪ 抵抗測定時に、プローブ・チップ電圧のHIもしくはLOを選択する押しボタン・スイッチです。
- ⑫ 抵抗測定用押しボタン・スイッチです。

VOLTS

- ⑬  dB測定用押しボタン・スイッチです。(AC電圧測定用押しボタン・スイッチと共に使用します。)
- ⑭ AC電圧測定用押しボタン・スイッチです。
- ⑮ DC電圧測定用押しボタン・スイッチです。
- ⑯ プラグインを抜く時に使うつまみです。
 機能説明の項をご参照下さい。

機能説明

DM501A型は本体に組み込んで電源をオンにした後、30分の子熱時間で仕様の精度を満足します。希望の測定項目とレンジを選択しますが、測定しようとする値が不明の時には最初最も高いレンジで測定します。フル・スケールの10%と100%の間に測定結果が入るようにレンジを設定すれば、最適な分解能が得られます。入力信号がその設定レンジを超えた時、すなわち表示が19999を超えた場合には表示が点滅して過大入力を知らせます。1000V DC、および500V ACレンジでは最大許容入力を超えても点滅しません。

注意

最大入力電圧を超えると機械に損傷を与えますのでご注意ください。

入力コネクタ 

前面パネルには4つの入力コネクタがあり、VOLTS/ Ω とLOW入力コネクタはDC電圧、AC電圧、dBV、dBm、ACおよびDC抵抗測定に使用します。mAとLOW入力コネクタはACおよびDC電流測定に使用します。

INPUT EXT-INT押しボタン・スイッチは前面パネルまたは後部インターフェイス入力の選択を行ないます。後部インターフェイスのピン28A (LO) と28B (HI) は電圧、dB、抵抗測定に使用します。TEMP入力コネクタは温度測定に使用します。

注意

200Vピークを超える電圧を後部インターフェイス・コネクタのピン28Aと28Bに加えることはできませんのでご注意ください。

通常の測定では、LOWコネクタと測定回路のコモンとを接続します。LOWコネクタと接続端子との接続はDM501A型のシャーシグラウンドと入力との比較が表示されます。本体の3線電源コードを通してLOWコネクタがアース・グラウンドに接続される場合にはご注意ください。

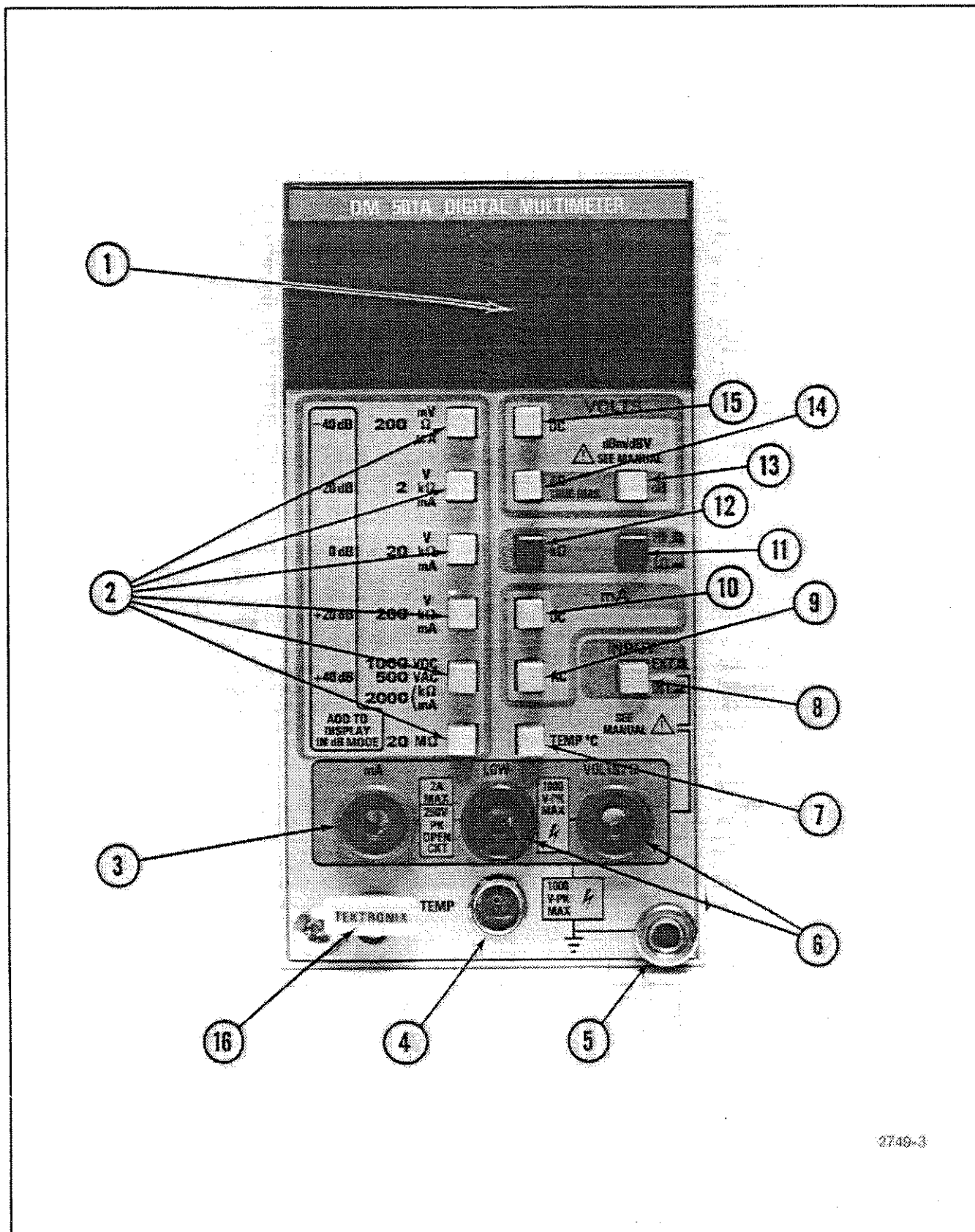

2749-3

2-2図 コントロールとコネクタ

注意

DM501A型による電圧測定時に人体に危害を与えないように、

1. 42.5Vピークを超える電圧を測定する時には電圧源に直接手を触れないようにご注意ください。
2. DM501A型からプローブをはずす前に測定回路側のプローブ端を先にはずして下さい。本体からDM501A型を引き抜く場合も同様です。

DC電圧測定

VOLTS DC ボタンを押しレンジを選びます。測定しようとする電圧をLOWとVOLTS/ Ω コネクタに入力します。前面パネルに書かれている最大入力電圧定格にご注意下さい。LOW入力コネクタに比べてVOLTS/ Ω コネクタに加わる電圧が大きい場合にはリードアウト表示は+になります。逆の場合には-になります。LOWとVOLTS/ Ω 入力コネクタをショートさせるとリードアウト表示は零になります。

DC電流測定

mA DC ボタンを押しレンジを選びます。測定しようとする電流をLOWとmAコネクタに入力します。LOWコネクタからmAコネクタに電流が流れる場合にはリードアウト表示は+になります。電流入力回路基板上にある内部ヒューズで保護されています。

AC電圧およびdB測定

AC電圧測定にはVOLTS AC ボタンを押しレンジを選びます。測定しようとする電圧をLOWとVOLTS/ Ω コネクタに入力します。AC電圧およびdB測定では真の実効値が計算されてリードアウト表示されます。電圧は波高率が4までの信号であれば測定できます。波高率はピーク電圧と実効値との比で表わされます。

dBで測定をするにはVOLTS ACとdB ボタンを押しレンジを選びます。+40dBレンジ以外ほどのレンジのボタンを押しても±20dBのダイナミックレンジを持っています。dB測定結果は設定したレンジに、リードアウト表示の値を加えることによって得られます。例えば-20dBレンジで-15.6のリードアウト表示であれば-35.6dBの信号という事になります。+40dBレンジでは、500V AC最大定格のために、最大リードアウト表示値は+16.2dBmもしくは+14dBVで制限されます。

DM501A型が工場から出荷される時には、0dBは600 Ω で1mW(0.7746V)になっています。内部ジャンパ線をかえることにより1Vで0dBにも変換できます。(校正手順の項をご参照下さい。)

AC電流の測定にはmAボタンを押しレンジを選びます。測定しようとするAC電流をmAとLOWコネクタに入力します。AC電流測定では真の実効値が計算されてリードアウト表示されます。

抵抗測定

k Ω ボタンを押しレンジを選びます。スケール・ファクタはレンジ切替の押しボタン・スイッチによって変わります。フル・スケールで最大電圧を得るようにHIまたはLOボタンを選びます。(表2-1)HIにした時の特長はノイズや熱電対(異種の金属接合)によって生じる誤差に影響されないことです。LOの場合には、ほとんどのシリコン型半導体素子に対してフォワード・バイアスすることなしに、インサーキット測定ができます。

k Ω 測定ではLOWとVOLTS/ Ω 入力コネクタに対して定電流を与えます。電流はVOLTS/ Ω コネクタからLOWコネクタに流れます。表2-1はフル・スケール時のリードアウト表示に対する電流値および入力コネクタ間の最大電圧を示しています。k Ω 測定時に、LOWコネクタに対するVOLTS/ Ω コネクタの最大(開放)電圧は約+6Vです。

表2-1 抵抗測定のソース電流と電圧値

レンジ	ソース電流		最大電圧 (フル・スケール)	
	HI	LO	HI	LO
200 Ω	1mA	1mA	0.2V	0.2V
2k Ω	1mA	100 μ A	2.0V	0.2V
20k Ω	100 μ A	10 μ A	2.0V	0.2V
200k Ω	10 μ A	1 μ A	2.0V	0.2V
2000k Ω	1 μ A	0.1 μ A	2.0V	0.2V
20M Ω	0.1mA	0.1 μ A	2.0V	2.0V

温度測定

前面パネルのTEMPコネクタにP6601型温度プローブを接続します。接続ピンに注意して差し込んで下さい。TEMP℃ボタンを押し、プローブの先端のチップを測定したい場所に接触させます。値を読取る前に、先端のチップの温度が十分安定するまで時間をかけて下さい。安定するまでの時間は、プローブと測定物(DUT)の熱容量および熱抵抗、DUTに与えられた熱の合計によって変わってきます。温度測定とプローブの使用方法についての詳しい説明はP6601型の取扱説明書をご覧ください。標準付属品(および部品番号)についてはメカニカル・パーツ表に記載されています。

梱包方法

納入時に機械が梱包されていた箱を使用すれば簡単に再梱包ができますが、もしその箱がない時には次のように行なって下さい。

機械の塗装を保護するためにポリエチレン・シートのような物でくるみます。機械の長さよりも15cm位長い丈夫なダンボール箱を用意し、その箱の中にウレタン・フォームのようなクッション材を、上下左右に均等に箱と機械のあいだに詰めます。箱をテープもしくは大型ホチキスでシーリングします。この機械については15kg/cm²以上の箱の強度があれば充分です。

WARNING

THE FOLLOWING SERVICING INSTRUCTIONS ARE FOR USE BY QUALIFIED PERSONNEL ONLY. TO AVOID PERSONAL INJURY, DO NOT PERFORM ANY SERVICING OTHER THAN THAT CONTAINED IN OPERATING INSTRUCTIONS UNLESS YOU ARE QUALIFIED TO DO SO. REFER TO OPERATORS SAFETY SUMMARY AND SERVICE SAFETY SUMMARY PRIOR TO PERFORMING ANY SERVICE.

THEORY OF OPERATION

Introduction

This section of the manual describes the circuits necessary to display in digital form, the value of an input voltage, current, resistance or temperature. Refer to the block diagram and the schematic diagrams (indicated by a diamond) in the diagram section for an overall view of the DM 501A operation, including typical input and output signal levels.

Voltage Input Circuits 1

The internal-external (INT-EXT) front-panel switch (S4-A and S4-B, see Fig. 3-1) is used to select either front-panel inputs or rear-interface inputs. In all functions except temperature, the LOW input connects to the main board floating ground (LO) through switches S4-A and S1-M.

A dc voltage applied to the VOLTS/ Ω connector passes through switches S1-C and S1-E to the top of the attenuator resistor series network consisting of R1112A, R1104 (20 Vdc), R1112B, R1110 (200 Vdc), R1112C, R1114 (1000 Vdc), and R1112D. The bottom end (pin 8) of R1112D is connected to floating ground through switch S1-E and S1-M. The input signal attenuation is selected by pressing the desired range switch for either 200 mV, 2 V, 20 V, 200 V, or 1000 V. The attenuated signal couples through switches S1-F, S1-D, S1-J, S1-L, and S1-N. The signal flows through R1613 (located on Diagram 2) to the Analog Converter (U1601 pin 15). Resistor R1613 is a current limiting component that protects U1601 from overload.

In the ac voltage function (see Fig. 3-2), switch S1-C is open (depressed position) and capacitor C1100 ac couples the input signal to the attenuator. Capacitors

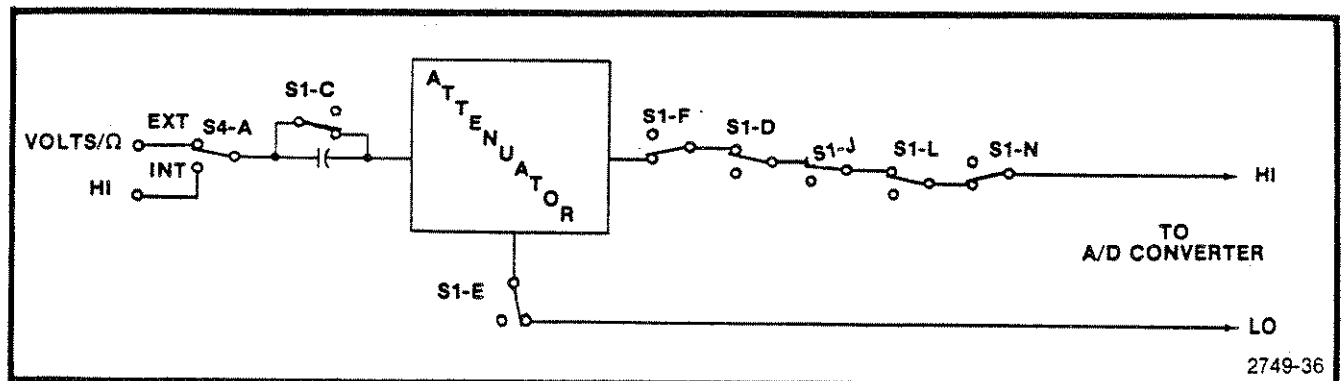

Fig. 3-1. Dc volts switching.

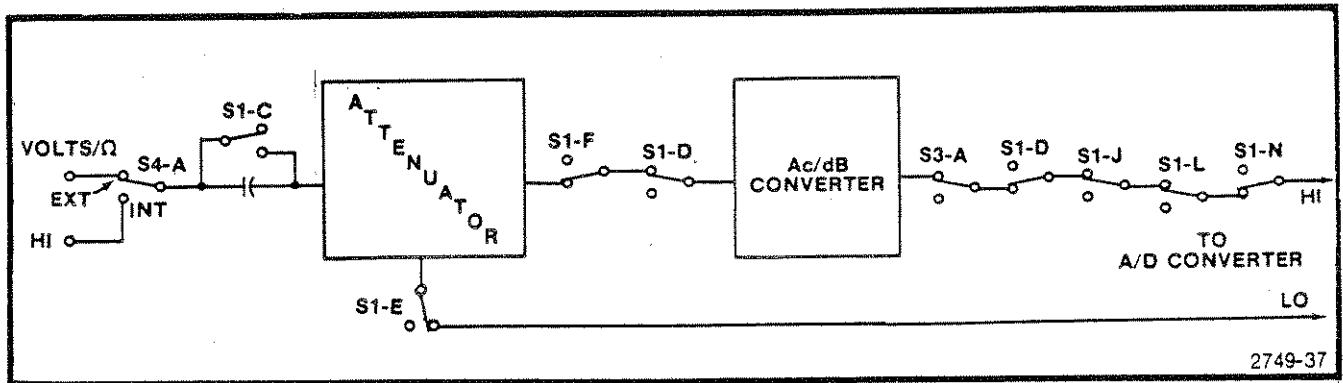

Fig. 3-2. Ac volts switching.

C1110, C1114 (20 Vac), and C1112 comprise the 20 Vac compensation. Capacitors C1120, C1128 (200 Vac), and C1122 comprise the 200 Vac compensation. The 500 Vac compensation consists of C1126, C1129 (500 Vac), and C1124. The attenuated signal passes through switches S1-F and S1-D (pin 3) and resistor RT1633 to the input of the AC Buffer (U1539). Simultaneously, the other half of switch S1-D (pin 5) couples the output of the dB Converter (U1429) through switch sections S3 and S1 to the Analog Converter, pin 15.

In the 200 mVac range position, switch S2-C activates relay K1528, which sets the AC Buffer (U1539) for X10 gain. Resistor R1539 and U1539 feedback resistor R1538 comprise the X1 and X10 gain setting network. The output of U1539 (pin 6) is coupled through capacitor C1539 and R1537 (2 Vac GAIN) to the input of U1429 (pin 1). The dB Converter (U1429) computes the rms level of the input ac signal and outputs the equivalent dc level on pin 8. This output signal (HI) is appropriately switch coupled through resistor R1613 (located on diagram 2) to the Analog Converter (U1601 pin 15).

The resistor (RT1633) with diodes CR1631 and CR1632 protect U1539 from input voltage overloads. When an overload occurs, diodes CR1631 and CR1632 clamp the signal at 0.7 V above or below the power supply voltage causing RT1633 to heat. When reaching the trigger Temperature, RT1633 will effectively open or achieve a very high resistance, thus limiting the input current to U1539.

dB Input Circuitry 1 (Refer to Fig. 3-3)

The dB Converter (U1429) also converts the ac signal input (pin 1) to a dc voltage proportional to dB at pin 5. This dc voltage is then coupled to pin 7, which has a resistor network to set the dB reference current and a jumper (J1435) that selects the dBm or dBV mode.

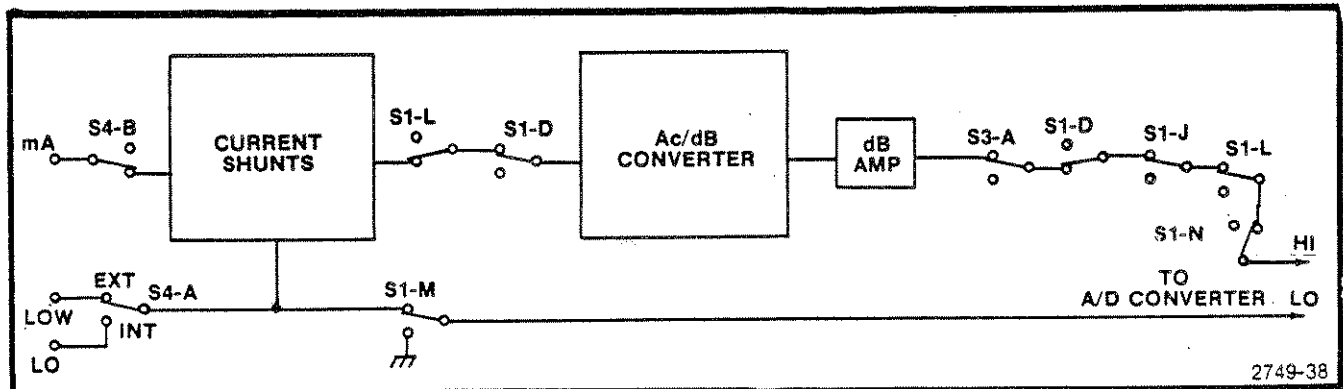

Fig. 3-3. dB switching.

With the jumper in the dBm mode, R1535 (dB \emptyset) is adjusted for \emptyset dBm when the \emptyset dB range switch is depressed and 0.7746 Vac is connected between the VOLTS/ Ω and LOW front-panel connectors.

When the jumper is in the dBV mode and the input signal is 1.000 Vac, the display readout is also \emptyset dB. The signal at U1429 (pin 7) is internally buffered and applied to pin 6 (dB BUF OUT). This signal changes approximately -3 mV per 1 dB change. The positive temperature coefficient resistor (RT1525) is used to provide compensation for the 0.3% per degree C temperature drift in the dB converter of U1429.

Potentiometer R1528 (dB Gain) in combination with U1538 (dB AMP), RT1525, and feedback resistor R1536, is used to scale the dB buffer output signal to 100 mV per dB at the input of U1538 (pin 6). This output signal feeds through switch sections S3 and S1, to resistor R1613 (located on diagram 2), then into the Analog Converter (U1601 pin 15).

When dB is selected, the display is limited to 0.1 dB resolution. This reduced resolution occurs when dB switch S3-A (pin 3) connects +5 V to Digit Select Driver U1701 (pin 1). The output of U1701 (pin 16) turns on diodes CR1605 and CR1607, disabling the digit select lines for the two least significant digits in the display (DS1200 and DS1101). Simultaneously, +5 V is coupled through diode CR1711 turning on the SIGN (DS1000) in the display. This same high level disables integrated circuits U1703A, U1703B, and U1705B and enables U1705A. The decimal point is displayed after the second most significant digit ranges.

Current Input Circuits 1 (Refer to Fig. 3-4 and Fig. 3-5)

The current input is only available through the front-panel mA and LOW connectors. Input current to the mA connector flows through fuse F1626 and the appropriate range switch and shunt resistors consisting of R1628A, B, and C and R1711 and R1713. In dc current function, with the mA dc front-panel switch (S1-J pin 4) closed, the voltage drop across the shunt resistors is directly coupled

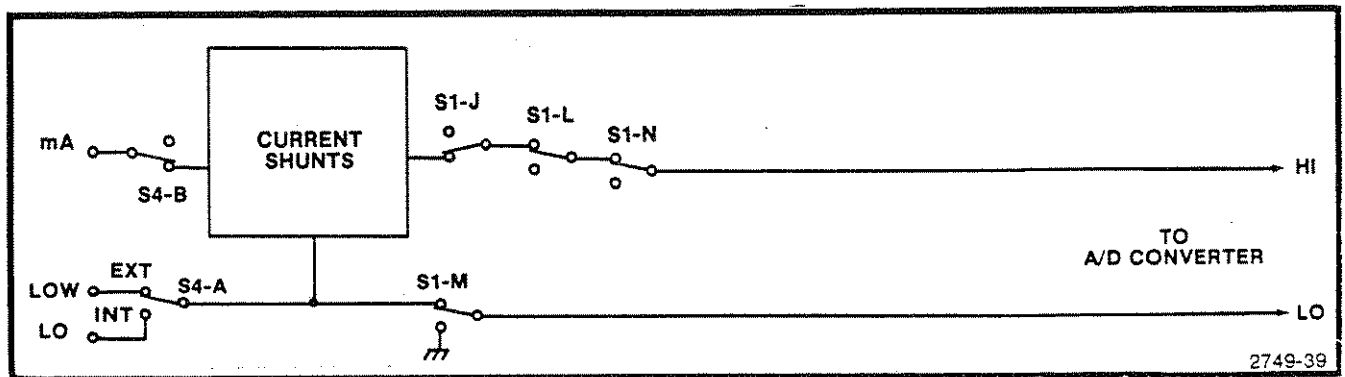

Fig. 3-4. Dc current switching.

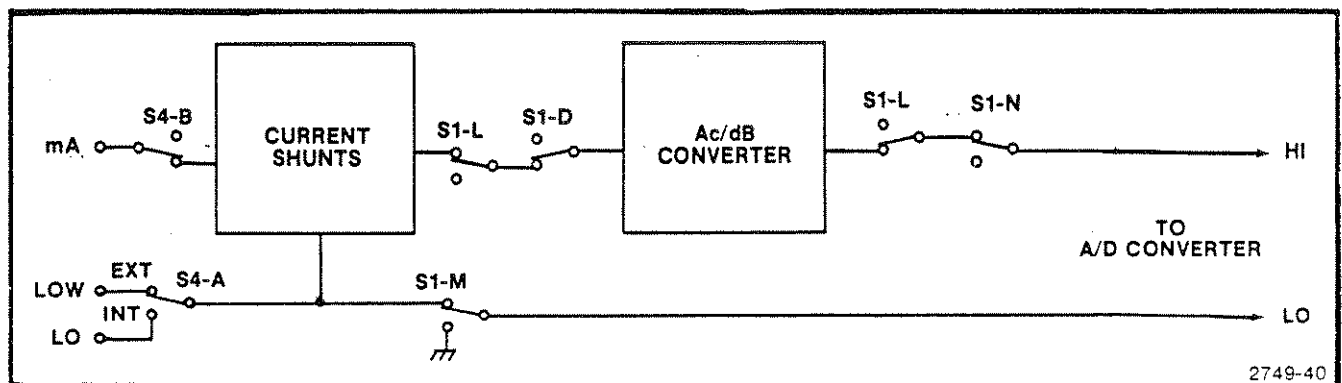

Fig. 3-5. Ac current switching.

to the Analog Converter (U1601 pin 15). In ac current function, the mA ac front-panel switch (S1-L pin 4) is closed. The voltage developed across the input current shunt is coupled to AC Buffer U1539, which is connected (by Relay K1528 energizer) as a X10 gain amplifier. The voltage at pin 6 of U1539 feed through R1537 to converter U1429 (pin 1) and outputs at pin 8 of U1429. Through appropriate switching, U1429 pin 8 output voltage couples to the Analog Converter, U1601 pin 15. Ac current is also measured as a true rms ac function.

The Ohms Reference Current Source, Q1415 and associated circuitry, generates a $100\ \mu\text{A}$ reference current. This current either flows through R1516 or R1516 in parallel with the series combination of R1515 and R1412 (LO Ω) depending on which ohms function and range is selected. This reference current develops either 1 V or 10 V across R1516. The Ohms Converter (U1515 and Q1525) applies 1 V or 10 V across the attenuator section selected by the range switches. The attenuator current, determined by the range switches, flows through ohms protection resistor RT1102 and out the VOLTS/ Ω front-panel connector or rear interface connector (pin 28B) through the unknown resistance to the LOW front-panel or rear interface connector (pin 28A). The output current from the VOLTS/ Ω or rear interface connector varies between $100\ \mu\text{A}$ and 1 mA in decade steps, depending on the selected range.

Ohms Converter 1 (Refer to Fig. 3-6)

The ohms converter circuitry generates a known current that flows out the front-panel VOLTS/ Ω connector through the unknown resistance. The voltage developed at the input connectors is proportional to the unknown resistance. This voltage is sensed by the a/d converter and displayed as an ohms value.

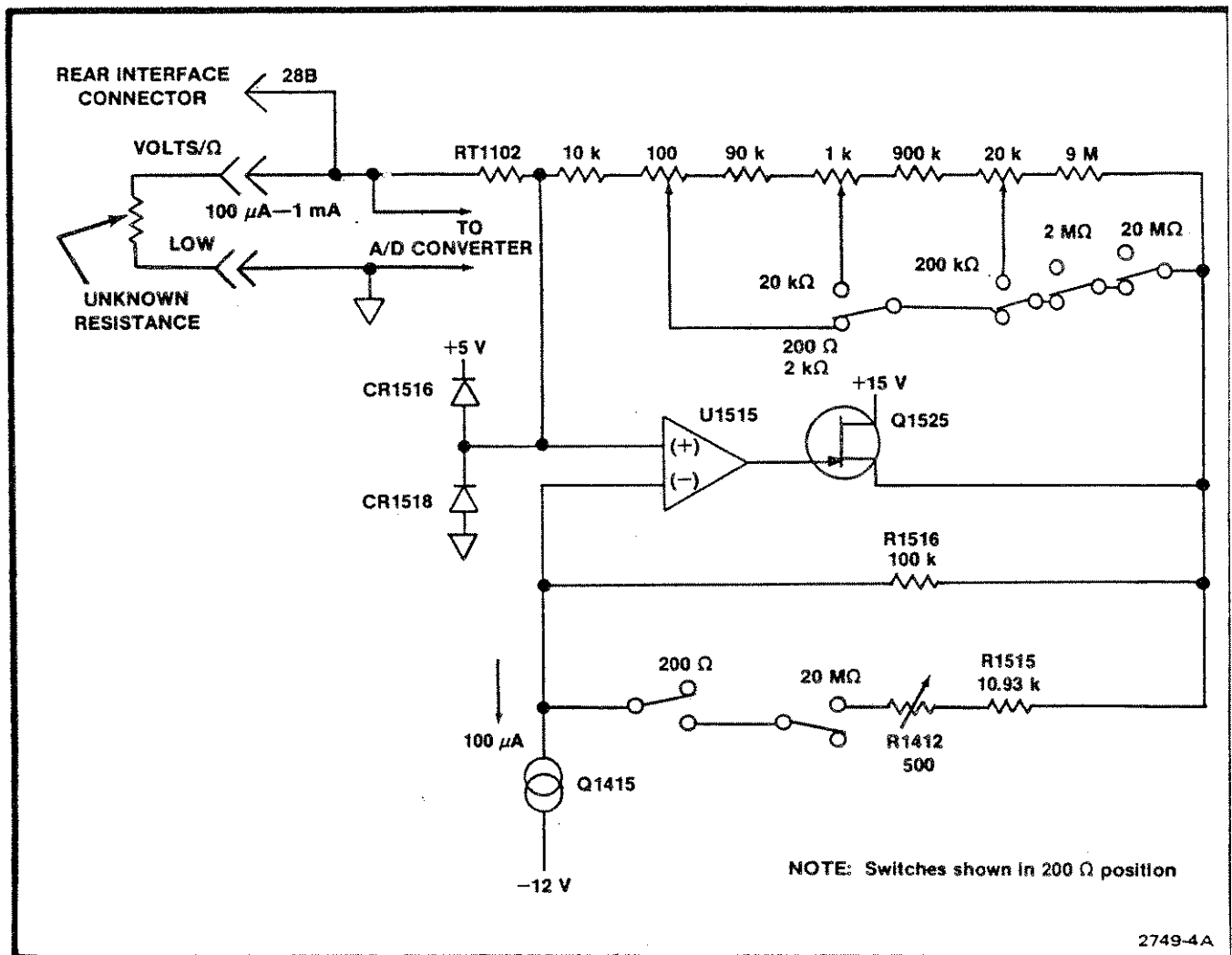

Fig. 3-6. Simplified ohms converter diagram.

Circuit protection to the ohmmeter function is provided by resistor RT1102 and clamping diodes CR1516 and CR1518. A voltage source inadvertently applied in the ohmmeter function will cause RT1102 to heat and effectively open.

Temperature Measurement Circuitry 3

The temperature circuitry is designed to operate with the P6601 Temperature Probe. The temperature sensing element consists of a thin-film platinum resistor in the tip of the probe. The sensor resistance, which is a function of temperature, is: $R = (R_0 + \alpha T + \beta T^2)$, where R_0 is 100 Ω , α is equal to 0.3738 Ω per degree C, and β is equal to $-8.85 \times 10^{-5} \Omega/^\circ\text{C}^2$ (nominal coefficient). T is temperature in degrees Celsius.

A 1 mA current source from transistor Q1731, zener diode VR1636, and related circuitry flows through the temperature probe sensor. When the temperature changes, the sensor resistance changes, which causes the voltage developed across the sensor to change. This voltage is shifted and amplified by the Temperature Amplifier (U1737). The output of U1737 (pin 6) applies this temperature probe signal to a network consisting of components R1931, CR1935, R1935, R1932, R1933, CR1934, and R1934. This network helps compensate for the non-linear function of the temperature probe. With diode CR1935 setting a break point at an equivalent 75 $^\circ\text{C}$ and diode CR1934 setting a break point at approximately 125 $^\circ\text{C}$, the output is somewhat linearized and equal to $\approx 1 \text{ mV}/^\circ\text{C}$ times probe temperature.

When the front panel TEMP $^\circ\text{C}$ push button is depressed, switch S1-N couples this temperature output to Analog Converter U1601 (pin 15).

Analog-to-Digital Converter 2

The analog-to-digital converter (a/d converter) in the DM 501A uses a Siliconix type LD120 analog converter (U1601) and a type LD121 digital converter (U1603) to convert the analog input voltage to a digital representation.

The Analog Converter (U1601) contains an input buffer-integrator-comparator and an auto-zero amplifier.

The Digital Converter (U1603) contains the necessary control logic for the analog converter as well as the buffers, multiplexers, latches, and counters needed to drive the display circuitry.

The basic sensitivity of the a/d converter is 2 V full scale indication, which is set by R1505 (2 Vdc). The 200 mV full scale input for the a/d converter is set by R1504 (200 mVdc) when the relay K1505 is energized through switches S1 and S2. The 2 Vdc \emptyset (R1405) is used to set the initial zero for the a/d converter when in the 2 V full scale mode. When the a/d converter input is set for 200 mV full scale mode, relays K1408 and K1505 are energized. The 200 mVdc \emptyset (R1415) is now in the circuit to adjust for the initial zero offset.

The a/d converter operates on a charge-balancing technique. The input voltage is converted to a current that charges integrator capacitor C1508. The converter counts the units of charge needed to keep the integrator output near zero. (See Fig. 8-2 in the Diagrams section.)

The conversion cycle is 49,152 clock pulses long of which 16,384 pulses are used in the AUTO-Zero (AZ) interval and 32,768 pulses are used in the measure interval.

Auto-Zero Period

The a/d converter system during the Auto-Zero period is represented by Fig. 3-7. In the A/Z period, the input buffer is connected to reference ground and the A/Z buffer input is connected through R1507 to the integrator output. Note the M/Z line is low. The U/D line is being toggled at a 50% duty cycle, which results in a current through R1605 and R1505 at one-half of $V_{\text{ref}} \div R_1$. The dynamics of the a/d converter system causes the voltage on capacitor C1505 (C_{int}) to attain the value required for the sum of the currents entering the integrator summing node to be zero. The A/Z voltage on C1505 is approximately -2 V , which is equivalent to the integrator output voltage.

Measure Interval

During the measure interval (see Fig. 3-8), the input buffer is connected to V_{in} and supplies the integrator with a current equal to $V_{\text{in}} \div R_2$. Capacitor C1505 (C_{int}) is disconnected from the integrator output. The current developed from V_{in} causes the integrator output voltage to move from V_{AZ} . Digital converter U1603 attempts to keep the integrator output voltage close to V_{AZ} by adding or subtracting units of charge to integrator capacitor C1508 (C_{int}). With a unit of charge equal to 14 counts, the net amount of charge for correction is totaled by the BCD counters. The measure interval can only resolve multiples of 14 counts.

Override Period

The override period immediately follows the measure interval and resolves the last of the measurement. The input buffer now connects to the high quality ground and the C_{AZ} switch is left open. The LD121 (U1603) causes the

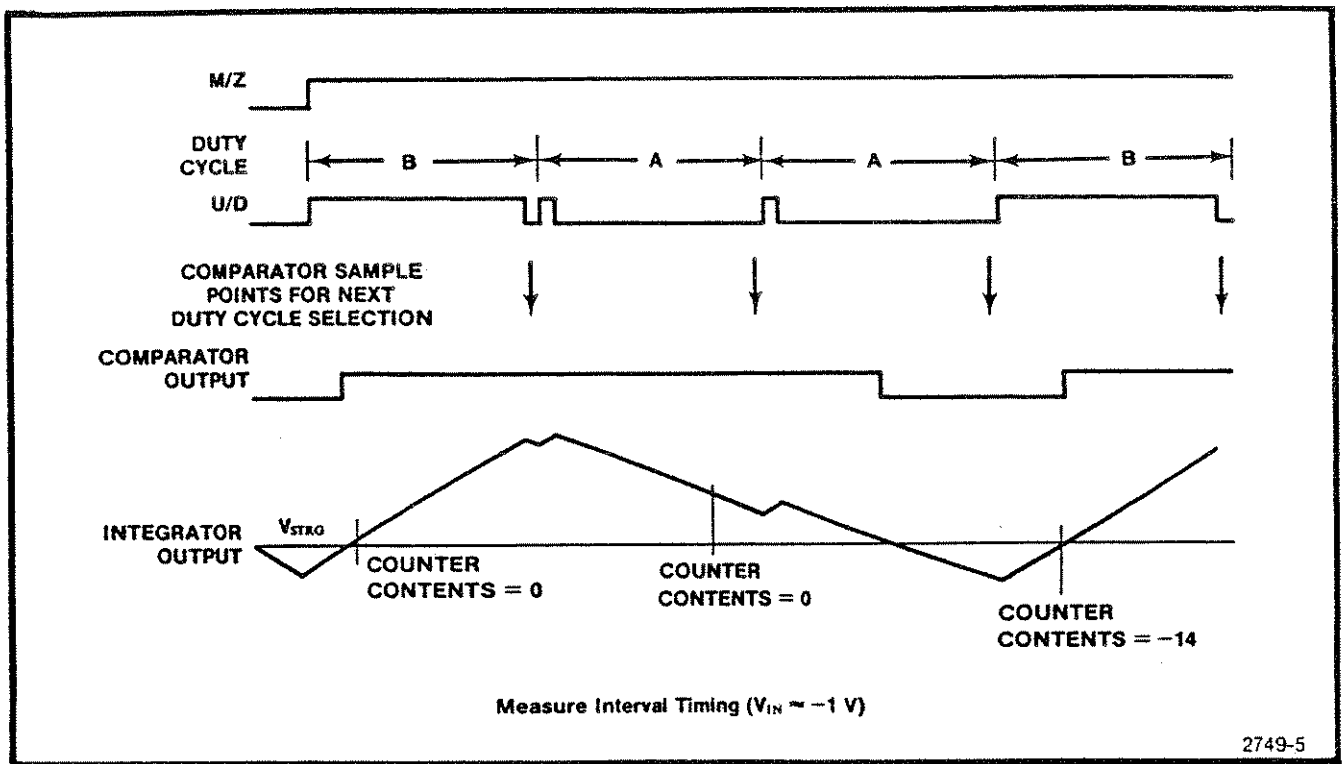

Fig. 3-7. Measure interval timing.

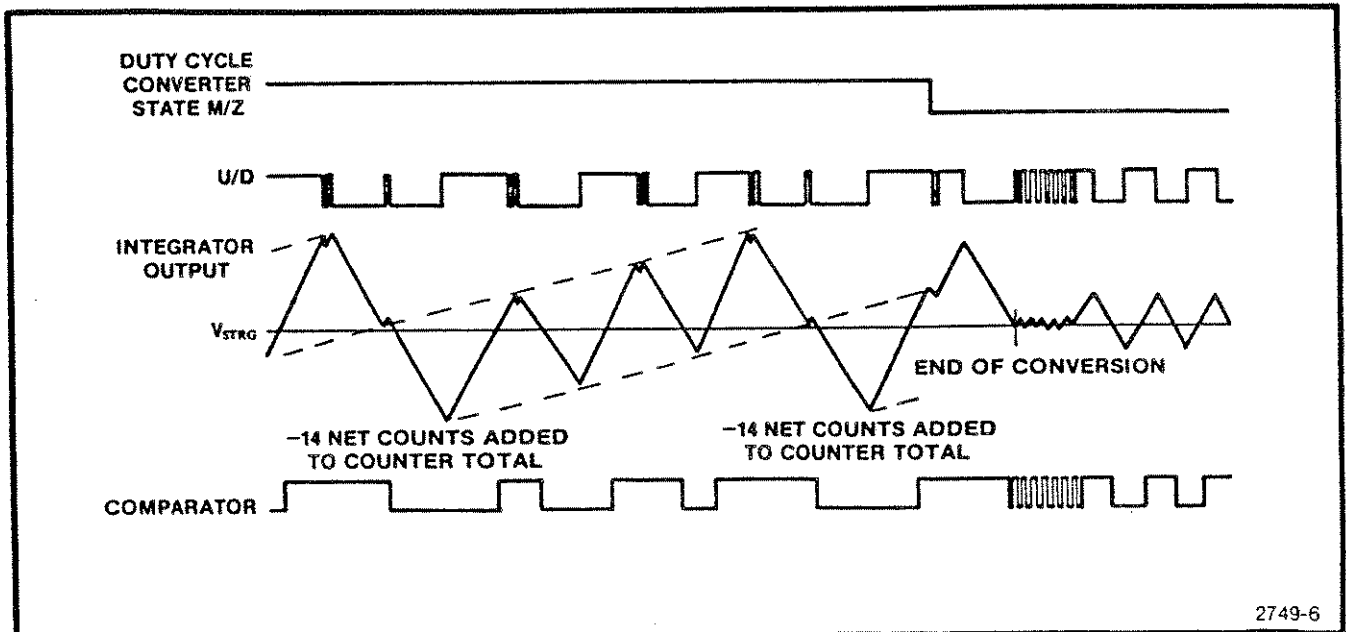

Fig. 3-8. Algorithm waveforms at end of measure interval.

integrator to go positive with respect to V_{AZ} (see Fig. 3-7), then returns it to V_{AZ} potential, stopping only when the LD120 (U1601) comparator changes state. The count is in single clock times.

The override period can exist a maximum of 56 clock times into the zero period, assuming the non-overload V_{in} . Since only 14 of the 16 counts in the U/D waveform (see Fig. 3-9) produce net counts, there are $\pm 28,672$ counts maximum out of the measure period of 32,768 clock times available.

At the end of the measure period (after the last count cycle has accumulated its counts), the data in the counter is transferred to the data latches. The data is then multiplexed to the bcd outputs at the time the proper digit select line is enabled.

The digit select lines drive U1701, Digit Select Driver, which pulls down on the appropriate display common cathodes. During the time when each of the digit select lines on U1603 is enabled, the corresponding digit information is available at the bcd output.

Display Driver 2

Display driver U1805 is a bcd to 7-segment decoder. The bcd digit information is decoded by U1805 and applied to the cathodes of 7-segment displays DS1000, DS1001, DS1100, DS1101, and DS1200. The output of U1805 is an active high that pulls up on the appropriate LED anodes. Figure 3-10 shows the waveforms available at the digit select lines and also the SIGN output. In addition to the sign information, the SIGN output also has the overrange and underrange information. The sign information is the only information used in this design.

Clock 2

The clock for the LD121 (U1603) consists of Q1435, crystal Y1425, and associated circuitry. This clock circuit is a Pierce coupled oscillator that oscillates at 163.84 kHz.

Decimal Point Circuitry 2

The decimal point circuit is composed of U1703, U1705, U1707, and associated circuitry. The decimal point line is only enabled when one of the range switches is selected and anded with a digit select line to turn on Q1805. The anded signal pulls the decimal point line high, turning on the appropriate decimal point at the correct time.

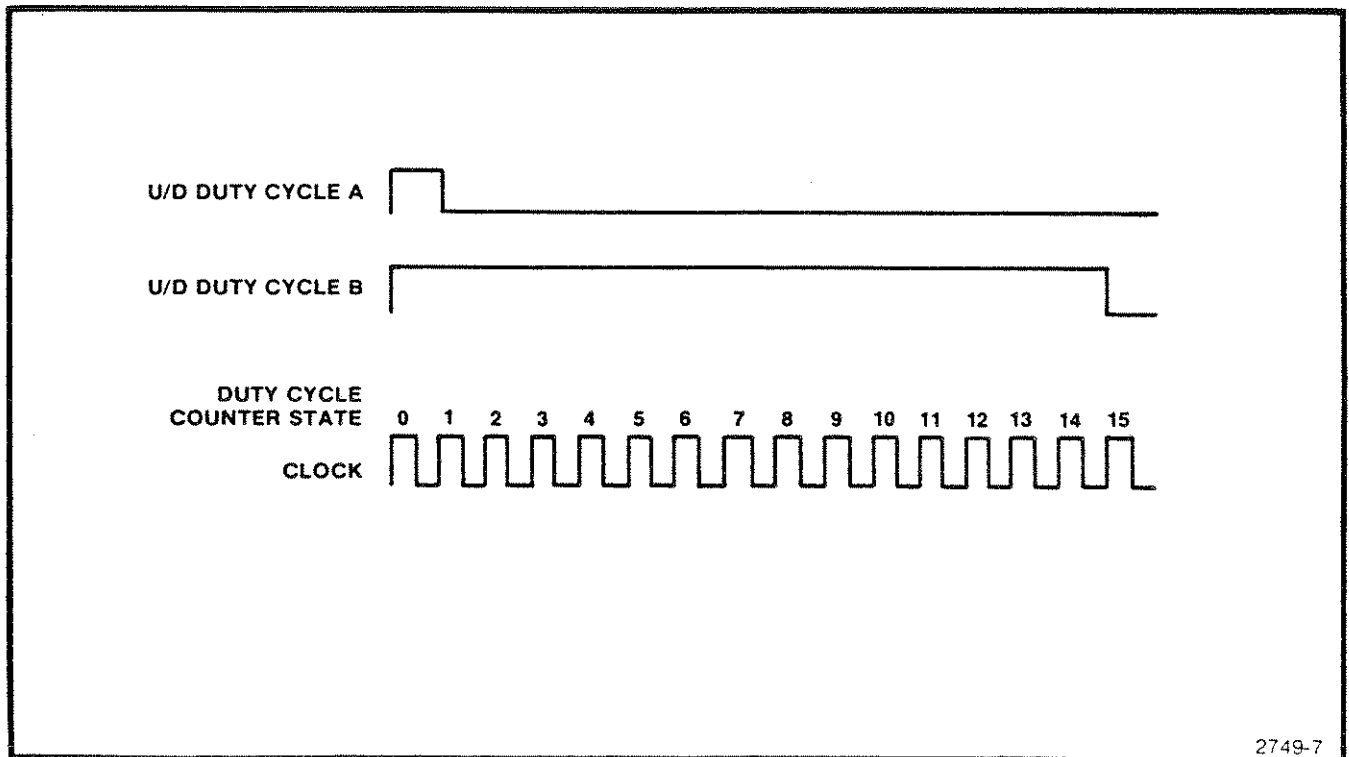

Fig. 3-9. Modulo 16 dual duty cycle counter waveforms.

Power Supply 3

The 25 Vac input to isolation transformer T1301 is supplied from the power module through rear interface pins 13A and 13B. The output voltage from pins 7 and 9 is rectified by CR1422 and applied to U1325 and U1335. These three-terminal regulators provide the +15 V source and -12 V source.

The output voltage from T1301, pins 10 and 12, is rectified by CR1424 and CR1426 and applied to U1431. This three-terminal regulator provides the +5 V source.

All three-terminal regulators are internally current limited.

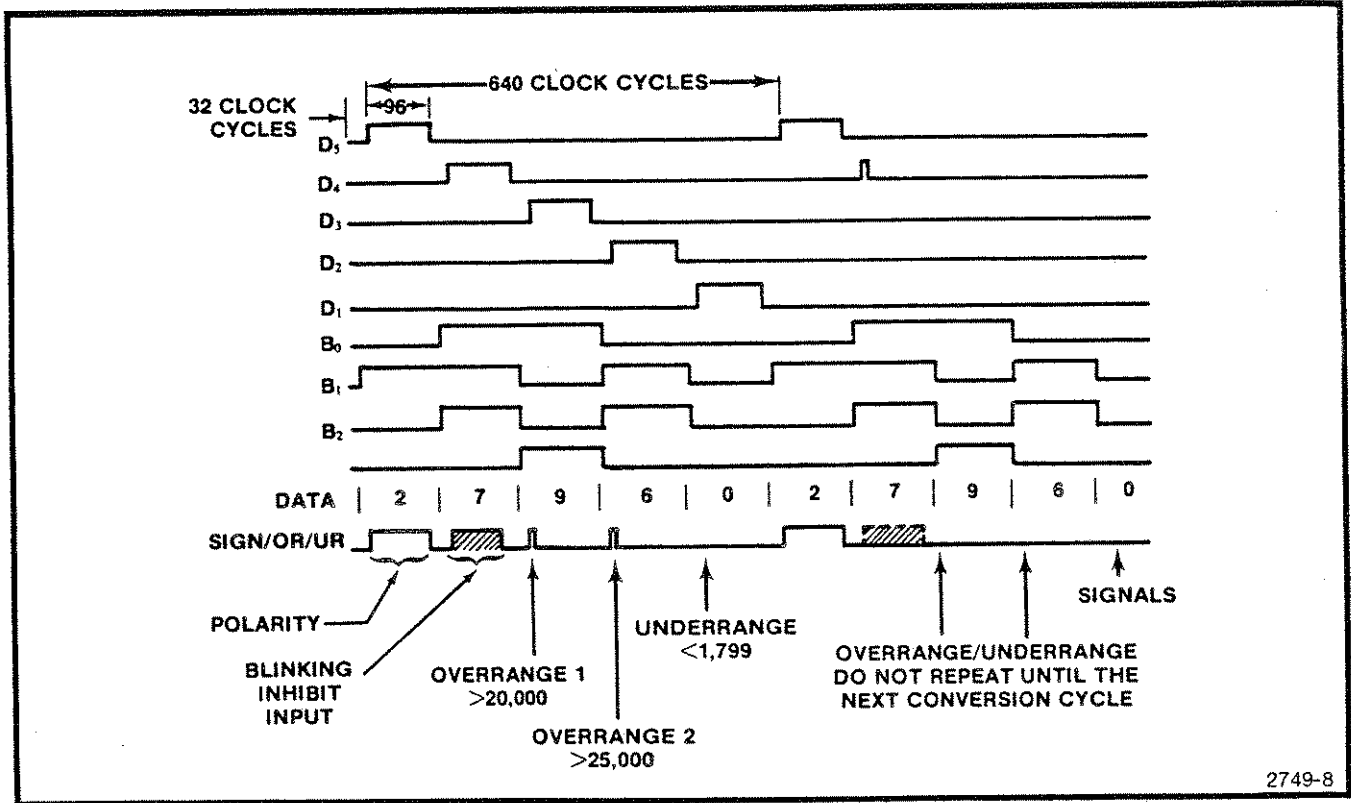

Fig. 3-10. LD121 data output waveforms.

CALIBRATION PROCEDURE

PERFORMANCE CHECK PROCEDURE

Introduction

This procedure checks the electrical performance requirements as listed in the Specification section in this manual. Perform the Adjustment procedure if the instrument fails to meet these checks. In some cases, recalibration may not correct the discrepancy; circuit troubleshooting is then indicated. Also, use this procedure to determine acceptability of performance in an incoming inspection facility.

For convenience, many steps in this procedure check the performance of this instrument at only one value in the specified performance range. Any value within the specified range, within appropriate limits, may be substituted. Performance requirements for various temperature ranges are listed in this procedure; when performing the procedure, use only the Display Limits listed for the ambient temperature in which the instrument is operating.

To check the rear interface accuracy specifications, access the rear interface pins 28A (LO) and 28B (HI) with a TM 500-series Option 2 power module. Instructions and accuracy tables for rear interface performance checks are given following this procedure.

Calibration Interval

To ensure instrument accuracy, check the calibration every 1000 hours of operation or at a minimum of every six months if used infrequently.

Services Available

Tektronix, Inc. provides complete instrument repair and adjustment at local field service centers and at the factory service center. Contact your local Tektronix field office or representative for further information.

Test Equipment Required

The following test equipment, or equivalent (refer to Table 4-1), is suggested to perform the Performance Check and Adjustment Procedure.

Table 4-1

LIST OF TEST EQUIPMENT REQUIREMENTS

Description	Performance Requirements	Applications	Example
Power Module		All tests.	TEKTRONIX TM 503 or TM 504.
Digital Voltmeter	Range, 0 to 50 V; accuracy, $\pm 0.1\%$.	Voltage measurement.	TEKTRONIX DM 501A*, DM 502A*, DM 505*.
Ac-Dc Current Source	Range, 0 to 2 A, sine-wave from 20 Hz to 10 kHz; accuracy, $\pm 0.06\%$. Range, 0 to 2 A, dc accuracy, $\pm 0.02\%$.	Ac-Dc ammeter accuracy check.	Valhalla Scientific Inc. 2500 Ac-Dc Current Calibrator.
Dc Voltage Source	Range, 0 to 1000 V; accuracy, $\pm 0.01\%$.	Dc voltmeter accuracy check.	Fluke Model 343A or 341A Dc Voltage Calibrator.
Ac Voltage Source	Range, 0 to 500 V; accuracy, $\pm 0.05\%$, 20 Hz to 20 kHz. Adjustable ± 0.2 Hz at 50 Hz and 60 Hz.	Ac voltmeter accuracy check.	Fluke Model 5200A Ac Calibrator and Fluke Model 5215A Power Amplifier.

Table 4-1 (cont)

Description	Performance Requirements	Applications	Example
Resistance Standard	Range, 0 to 20 M Ω ; accuracy, $\pm 0.05\%$.	Ohmmeter accuracy check.	Electro Scientific Industries, Inc. Model DB 62 Dekabox.
Temperature Bath	Range, -62°C to $+240^{\circ}\text{C}$; accuracy, $\pm 0.25^{\circ}\text{C}$.	Temperature probe check and adjustment.	Neslab Instruments Inc., Model ULT-80 Bath Circulator with denatured ethyl alcohol coolant, Model TX-9 ^b Circulator with Dow Corning 710 fluid and necessary hoses and adapters.

^aRequires a TM 500-series power module.

^bConnect the TX-9 cooling coil to the cooling pump in the ULT-80 to obtain temperatures between $+10^{\circ}\text{C}$ and $+40^{\circ}\text{C}$.

WARNING

Dangerous voltages may be encountered in the following steps. Caution must be exercised. Do not contact the output connectors of the voltage calibrator, the input terminals of the DM 501A, or the internal circuitry of the DM 501A.

FRONT PANEL INPUT ACCURACY CHECKS

1. Check Dc Voltage Accuracy

- a. Set the dc voltage calibrator for a minimum output voltage.
- b. Press the VOLTS DC function push button switch.
- c. Connect the dc voltage calibrator to the VOLTS/ Ω and LOW connectors through appropriate cables and adapters.
- d. Press the range push buttons and set the calibrator voltages as listed in Table 4-2.
- e. Check—that the DM 501A display reads within the display limits for the ambient temperature as listed in Table 4-2.
- f. Set the calibrator for a minimum output voltage.
- g. Remove all connections.

2. Check Dc and Ac Common Mode Rejection Ratios

- a. Connect a bnc female-to-dual banana connector to the VOLTS/ Ω and LOW connectors.
- b. Connect a dual-binding post with bnc male connector to the bnc female connector of the dual banana connector.
- c. Connect a 1 k Ω resistor between the binding posts.
- d. Connect the red lead of a clip lead adapter to female bnc connector to the red binding post (one side of the resistor).
- e. Connect the black lead of the clip lead adapter to the ground binding post of the DM 501A.
- f. Connect the bnc female connector through a coaxial cable to the dc voltage calibrator.
- g. Press the VOLTS DC function push button.

- h. Press the 200 mV range push button.
- i. Set the dc voltage calibrator for 10.00 V output.
- j. Check—the display for a reading of ≤ 00.13 .
- k. Move the red lead of the clip lead adapter to black binding post and repeat part j.
- l. Replace the dc voltage calibrator with an ac voltage calibrator.
- m. Set the ac calibrator for a 10 V ac rms output at either 50 or 60 Hz ± 0.2 Hz.
- n. Check—the display for a reading of ≤ 01.44 .
- o. Press the VOLTS AC TRUE RMS function push button.
- p. Check—the display for a reading of ≤ 14.33 .
- q. Move the red lead of the clip lead adapter back to the side of the resistor connected to the red binding post.
- r. Check as per part p.
- s. Press the VOLTS DC function push button.
- t. Check as per part n.
- u. Remove the connections to the DM 501A.

3. Check Dc Normal Mode Rejection (60 dB)

- a. Connect a bnc female-to-dual banana connector to the VOLTS/ Ω and LOW connectors.
- b. Connect the bnc female connector through a coaxial cable to the ac voltage calibrator.
- c. Press the VOLTS DC function push button.

- d. Press the 200 mV range push button.
- e. Set the ac calibrator for 1 V ac rms output at either 50 or 60 Hz, ± 0.2 Hz.
- f. Check—the display for a reading of ≤ 01.41 .

4. Check Ac Voltage Accuracy

- a. Connect the ac voltage calibrator to the VOLTS/ Ω and LOW connectors through appropriate cables and connectors.
- b. Press the VOLTS AC TRUE RMS function push button.
- c. Press the range push button and set the calibrator voltage as listed in Table 4-3.
- d. Check—that the DM 501A display reads within the display limits for the ambient temperatures and frequencies as listed in Table 4-3.
- e. Set the ac calibrator to a minimum voltage.

5. Check dBm Accuracy (Factory Shipped with internal jumper set for dBm readout)

- a. Press the VOLTS AC TRUE RMS and dB push buttons.
- b. Connect the ac voltage calibrator to the VOLTS/ Ω and LOW connectors through appropriate cables and connectors.
- c. Press the range push button and set the calibrator voltage and frequency as listed in Table 4-4.
- d. Check—that the DM 501A display readout is within the display limits for the ambient temperatures and frequencies as listed in Table 4-4.

Check dBV Mode limits. The check procedure is identical to the setup for the dBm Accuracy check with the exception of using the range push buttons and calibrator voltages as listed in Table 4-5.

6. Check Ohms Accuracy

- a. Connect a resistance standard to the VOLTS/ Ω and LOW connectors.
- b. Press the k Ω function push button and the appropriate HI or LO push button as indicated in Table 4-6.
- c. Press the range push button and set the resistance standard as listed in Table 4-6.
- d. Check—that the DM 501A display reads within the display limits for the ambient temperature as listed in Table 4-6.
- e. Remove all connections.

7. Check Dc Current Accuracy

- a. Connect the dc current source to the mA and LOW connectors through appropriate cables and connectors with the positive source to the mA connector.
- b. Press the mA DC function push button.
- c. Press the range push button and set the current source as listed in Table 4-7.
- d. Check—that the DM 501A display readout is within the display limits for the ambient temperature as shown in Table 4-7.
- e. Remove the dc current source and all connections.

8. Check Ac Current Accuracy

- a. Connect the precision ac current source to the mA and LOW connectors through appropriate cables and connectors.
- b. Press the mA AC function push button.
- c. Press the range push button and set the current source as listed in Table 4-8.
- d. Check—that the DM 501A display reads within the display limits for the ambient temperature as listed in Table 4-8.

- e. Remove the AC current source and all connections.

9. Check Temperature Accuracy

- a. Connect the temperature probe to the TEMP connector located on the front panel.
- b. Press the TEMP $^{\circ}$ C push button.
- c. Set the temperature bath for the first temperatures shown in the Temperature column in Table 4-9.
- d. Insert the probe in the bath and allow the probe to stabilize at the selected temperature.
- e. Check—that the display limits are as listed in Table 4-9.
- f. Repeat parts c, d, and e for the subsequent temperatures listed in Table 4-9.
- g. This completes the front panel performance check.

Rear Interface Accuracy Checks

To verify the accuracy of the dc voltage, ac voltage and resistance modes via the DM 501A rear interface, follow the steps outlined in the Performance Check Procedure for the front panel input connectors, but apply the voltages and resistances to rear interface pins 28B (HI) and 28A (LO). Access to the rear interface pins is most easily made using a TM 500-series, Option 2 power module.

Press the front panel EXT-INT push button to select rear interface input and use Table 4-10, Table 4-11, Table 4-12, Table 4-13, or Table 4-14 for the appropriate input voltages, frequencies, and display limits.

NOTE

The output cable fixture from the calibrating sources to the rear interface pins may have to be modified to accommodate accuracy checks via the rear interface.

Table 4-2

FRONT PANEL DC VOLTAGE ACCURACY

Range	Dc Calibration Voltage	DISPLAY LIMITS	
		Ambient Temp. Range +18°C to +28°C	Ambient Temp. Range 0°C to +18°C, +28°C to +50°C
200 mV	190.00 mV	190.13 to 189.87	190.24 to 189.76
2 V	1.9000 V	1.9012 to 1.8988	1.9024 to 1.8976
20 V	19.000 V	19.012 to 18.988	19.024 to 18.976
200 V	190.00 V	190.12 to 189.88	190.24 to 189.76
1000 V	1000.0 V	1000.7 to 999.3	1001.5 to 998.5

Table 4-3

FRONT PANEL AC VOLTAGE ACCURACY

Range	Ac Calibration Voltage	DISPLAY LIMITS			
		Ambient Temp. Range +18°C to +28°C		Ambient Temp. Range 0°C to +18°C, +28°C to +50°C	
		40 Hz to 10 kHz	20 to 40 Hz, 10 to 20 kHz	40 Hz to 10 kHz	20 to 40 Hz, 10 to 20 kHz
200 mV	190.00 mV	191.24 to 188.76	192.00 to 188.00	191.67 to 188.33	192.62 to 187.38
2 V	1.9000 V	1.9124 to 1.8876	1.9200 to 1.8800	1.9167 to 1.8833	1.9262 to 1.8738
20 V	19.000 V	19.124 to 18.876	19.200 to 18.800	19.167 to 18.833	19.262 to 18.738
200 V	190.00 V	191.24 to 188.76	192.00 to 188.00	191.67 to 188.33	192.62 to 187.38
500 V	500.00 V	504.0 to 496.0	506.0 to 494.0	505.5 to 494.5	508.0 to 492.0

Table 4-4

FRONT PANEL dBm ACCURACY

Calibration Frequency, 20 Hz to 20 kHz, +20 dB to -15 dB
20 Hz to 10 kHz, -15 dB to -20 dB

Range	Calibration Voltage	DISPLAY LIMITS	
		Ambient Temp. Range +18°C to +28°C	Ambient Temp. Range 0°C to +18°C, +28°C to +50°C
-40 dB	7.746 mV	-0.5 to +0.5	-1.1 to +1.1
-40 dB	77.46 mV	+19.5 to ^a +20.5	+18.9 to ^a +21.1
-40 dB	0.7746 mV	-19.5 to ^a -20.5 20 Hz to 2 kHz -18.5 to ^a -21.5 2 kHz to 10 kHz	-18.9 to ^a -21.1 20 Hz to 2 kHz -17.9 to ^a -22.1 2 kHz to 10 kHz
-20 dB	7.746 mV	-19.5 to -20.5 20 Hz to 2 kHz -18.5 to -21.5 2 kHz to 10 kHz	-18.9 to -21.1 20 Hz to 2 kHz -17.9 to -22.1 2 kHz to 10 kHz
-20 dB	77.46 mV	-0.5 to +0.5	-1.1 to +1.1
-20 dB	774.6 mV	+19.5 to ^a +20.5	+18.9 to ^a +21.1

^aWhen a 2 is displayed, the DM 501A overranges (flashing display) and illuminates the upper segment of the 1 in the most significant digit.

Table 4-5

FRONT PANEL dBV ACCURACY

Calibration Frequency, 20 Hz to 20 kHz, +20 dB to -15 dB
20 Hz to 10 kHz, -15 dB to -20 dB

Range	Calibration Voltage	DISPLAY LIMITS	
		Ambient Temp. Range +18°C to +28°C	Ambient Temp. Range 0°C to +18°C, +28°C to +50°C
-40 dB	10 mV	-0.5 to +0.5	-1.1 to +1.1
-40 dB	100 mV	+19.5 to ^a +20.5	+18.9 to ^a +21.1
-40 dB	1 mV	-19.5 to ^a -20.5 20 Hz to 2 kHz -18.5 to ^a -21.5 2 kHz to 10 kHz	-18.9 to ^a -21.1 20 Hz to 2 kHz -17.9 to ^a -22.1 2 kHz to 10 kHz
-20 dB	10 mV	-19.5 to -20.5 20 Hz to 2 kHz -18.5 to -21.5 2 kHz to 10 kHz	-18.9 to -21.1 20 Hz to 2 kHz -17.9 to -22.1 2 kHz to 10 kHz
-20 dB	100 mV	-0.5 to +0.5	-1.1 to +1.1
-20 dB	1 V	+19.5 to ^a +20.5	+18.9 to ^a +21.1

^aWhen a 2 is displayed, the DM 501A overranges (flashing display) and illuminates only the upper segment of the 1 in the most significant digit.

Table 4-6

FRONT PANEL RESISTANCE ACCURACY

Range	Resistance	DISPLAY LIMITS			
		Ambient Temp. Range +18°C to +28°C		Ambient Temp. Range 0°C to +18°C, +28°C to +50°C	
		HI	LO	HI	LO
200 Ω	190.00 Ω		190.32 to 189.68		190.62 to 189.38
2 kΩ	1.9000 kΩ	1.9032 to 1.8968	1.9032 to 1.8968	1.9062 to 1.8938	1.9062 to 1.8938
20 kΩ	19.000 kΩ	19.032 to 18.968	19.032 to 18.968	19.062 to 18.938	19.062 to 18.938
200 kΩ	190.00 kΩ	190.32 to 189.68	190.32 to 189.68	190.62 to 189.38	190.62 to 189.38
2000 kΩ	1900.0 kΩ	1903.2 to 1896.8	1906.0 to 1894.0	1906.2 to 1893.8	1923.3 to 1876.7
20 MΩ	19.000 MΩ	19.098 to 18.902		19.233 to 18.767	

Table 4-7

FRONT PANEL DC CURRENT ACCURACY

Range	Current	DISPLAY LIMITS	
		Ambient Temp. Range +18°C to +28°C	Ambient Temp. Range 0°C to +18°C, +28°C to +50°C
200 μA	190.00 μA	190.41 to 189.59	190.62 to 189.38
2 mA	1.9000 mA	1.9041 to 1.8959	1.9062 to 1.8938
20 mA	19.000 mA	19.041 to 18.959	19.062 to 18.938
200 mA	190.00 mA	190.41 to 189.59	190.62 to 189.38
2000 mA	1900.0 mA	1904.1 to 1895.9	1906.2 to 1893.8

Table 4-8

FRONT PANEL AC CURRENT ACCURACY

Range	Current	DISPLAY LIMITS	
		Ambient Temp. Range +18° C to +28° C	Ambient Temp. Range 0° C to +18° C, +28° C to +50° C
200 μ A	190.00 μ A	191.24 to 188.76	191.48 to 188.52
2 mA	1.9000 mA	1.9124 to 1.8876	1.9148 to 1.8852
20 mA	19.000 mA	19.124 to 18.876	19.148 to 18.852
200 mA	190.00 mA	191.24 to 188.76	191.48 to 188.52
2000 mA	1900.0 mA	1912.4 to 1887.6	1914.8 to 1885.2

Table 4-9

TEMPERATURE LIMITS

Temperature	DISPLAY LIMITS			
	Probe Calibrated To Instrument		Any Probe	
	Ambient Temp. Range		Ambient Temp. Range	
	+18° C to +28° C	0° C to +18° C +28° C to +50° C	+18° C to +28° C	0° C to +18° C +28° C to +50° C
-62° C	-60 to -64	-58.5 to -65.5	-58 to -66	-56.5 to -67.5
+125° C	+123 to +127	+121.5 to +128.5	+121 to +129	+119.5 to +130.5
+200° C	+194 to +200	+192.5 to +201.5	+192 to +202	+190.5 to +203.5

Table 4-10

REAR INTERFACE DC VOLTAGE ACCURACY

Range	Dc Calibration Voltage	DISPLAY LIMITS	
		Ambient Temp. Range +18° C to +28° C	Ambient Temp. Range 0° C to +18° C, +28° C to +50° C
200 mV	190.00 mV	190.13 to 189.87	190.24 to 189.76
2 V	1.9000 V	1.9012 to 1.8988	1.9024 to 1.8976
20 V	19.000 V	19.012 to 18.988	19.024 to 18.976
200 V	190.00 V	190.12 to 189.88	190.24 to 189.76
1000 V	190.00 V	190.3 to 189.7	190.7 to 189.3

Table 4-11
REAR INTERFACE AC VOLTAGE ACCURACY

Range	Ac Calibration Voltage	DISPLAY LIMITS			
		Ambient Temp. Range +18° C to +28° C		Ambient Temp. Range 0° C to +18° C, +28° C to +50° C	
		40 Hz to 10 kHz	20 to 40 Hz, 10 to 20 kHz	40 Hz to 10 kHz	20 to 40 Hz, 10 to 20 kHz
200 mV	190.00 mV	193.14 to 186.86	193.90 to 186.10	193.57 to 186.43	194.52 to 185.48
2 V	1.9000 V	1.9314 to 1.8686	1.9390 to 1.8610	1.9357 to 1.8643	1.9452 to 1.8548
20 V	19.000 V	19.314 to 18.686	19.390 to 18.610	19.357 to 18.643	19.452 to 18.548
200 mV	190.00 V	193.14 to 186.86	193.90 to 186.10	193.57 to 186.43	194.52 to 185.48
500 V	190.00 V	194.0 to 186.0	194.8 to 185.2	194.9 to 185.1	195.9 to 184.1

Table 4-12
REAR INTERFACE RESISTANCE ACCURACY

Range	Resistance	DISPLAY LIMITS			
		Ambient Temp. Range +18° C to +28° C		Ambient Temp. Range 0° C to +18° C, +28° C to +50° C	
		HI	LO	HI	LO
200 Ω	190.00 Ω		190.34 to 189.70		190.64 to 189.40
2 kΩ	1.9000 kΩ	1.9032 to 1.8968	1.9032 to 1.8968	1.9062 to 1.8938	1.9062 to 1.8938
20 kΩ	19.000 kΩ	19.032 to 18.968	19.032 to 18.968	19.062 to 18.938	19.062 to 18.838
200 kΩ	190.00 kΩ	190.32 to 189.68	190.32 to 189.68	190.62 to 189.38	190.62 to 189.38
2000 kΩ	1900.0 kΩ	1903.2 to 1896.8	1906.0 to 1894.0	1906.2 to 1893.8	1923.3 to 1876.7
20 MΩ	19.000 MΩ	19.098 to 18.902		19.233 to 18.767	

Table 4-13

REAR INTERFACE dBm ACCURACY

Calibration Frequency, 20 Hz to 20 kHz, +20 dB to -15 dB
20 Hz to 10 kHz, -15 dB to -20 dB

Range	Calibration Voltage	DISPLAY LIMITS	
		Ambient Temp. Range +18°C to +28°C	Ambient Temp. Range 0°C to +18°C, +28°C to +50°C
-40 dB	7.746 mV	-.6 to +.6	-1.2 to +1.2
-40 dB	77.46 mV	+19.4 to ^a +20.6	+18.8 to ^a +21.2
-40 dB	0.7746 mV	-19.4 to -20.6 20 Hz to 2 kHz -18.4 to -21.6 2 kHz to 10 kHz	-18.8 to -21.2 20 Hz to 2 kHz -17.8 to -22.2 2 kHz to 10 kHz
-20 dB	7.746 mV	-19.4 to -20.6 20 Hz to 2 kHz -18.4 to -21.6 2 kHz to 10 kHz	-18.8 to -21.2 20 Hz to 2 kHz -17.8 to -22.2 2 kHz to 10 kHz
-20 dB	77.46 mV	-.6 to +.6	-1.2 to +1.2
-20 dB	774.6 mV	+19.4 to ^a +20.6	+18.8 to ^a +21.2

^aWhen a 2 is displayed, the DM 501A overranges (flashing display) and illuminates only the upper segment of the 1 in the most significant digit.

Table 4-14

REAR INTERFACE dBV ACCURACY

Calibration Frequency, 20 Hz to 20 kHz, +20 dB to -15 dB
20 Hz to 10 kHz, -15 dB to -20 dB

Range	Calibration Voltage	DISPLAY LIMITS	
		Ambient Temp. Range +18°C to +28°C	Ambient Temp. Range 0°C to +18°C, +28°C to +50°C
-40 dB	10 mV	-.6 to +.6	-1.3 to +1.3
-40 dB	100 mV	+19.4 to ^a +20.6	+18.7 to ^a +21.3
-40 dB	1 mV	-19.4 to -20.6 20 Hz to 2 kHz -18.4 to -21.6 2 kHz to 10 kHz	-18.8 to -21.2 20 Hz to 2 kHz -17.8 to -22.2 2 kHz to 10 kHz
-20 dB	10 mV	-19.4 to -20.6 20 Hz to 2 kHz -18.4 to -21.6 2 kHz to 10 kHz	-18.8 to -21.2 20 Hz to 2 kHz -17.8 to -22.2 2 kHz to 10 kHz
-20 dB	100 mV	-.6 to +.6	-1.3 to +1.3
-20 dB	1 V	+19.4 to ^a +20.6	+18.7 to ^a +21.3

^aWhen a 2 is displayed, the DM 501A overranges (flashing display) and illuminates the upper segment of the 1 in the most significant digit.

ADJUSTMENT PROCEDURE

Introduction

Use this Adjustment Procedure to restore the DM 501A to original performance requirements. This Adjustment Procedure need not be performed unless the instrument fails to meet the Performance Requirements of the electrical characteristics listed in the Specification section, or if the Performance Check procedure cannot be completed satisfactorily. If the instrument has undergone repairs, the Adjustment Procedure is recommended.

Satisfactory completion of all adjustment steps in this procedure ensures that the instrument will meet the Performance Requirements.

Test Equipment Required

The test equipment (or equivalent) listed in Table 4-1 is required for adjustment of the DM 501A. Specifications given for the test equipment are the minimum necessary for accurate adjustment. All test equipment is assumed to be correctly calibrated and operating within specifications.

If other test equipment is substituted, calibration setup may need to be altered to meet the requirements of the equipment used.

Preparation

Access to the internal adjustments is achieved most easily when the DM 501A is connected to the power module with a flexible plug-in extender. Remove the left side cover of the DM 501A to access the adjustments on the main and attenuator boards. The electrical shield must be removed to make temperature adjustments. See Fig. 8-3 in the Diagram section at the rear of this manual.

Remove the power module cabinet to make adjustments to the DM 501A inside the power module. Install the DM 501A in the right side compartment of the power module with its unused compartments on the left side. Make adjustments at an ambient temperature between 21°C and 25°C (70°F and 77°F).

1. Check Power Supplies

- a. Set the test voltmeter to the 20 V range.
- b. Connect one lead of the voltmeter to the +15 V point located on the Main board, and the other lead to the LOW test point.
- c. Check—for a +15 V reading, $\pm 6\%$ (between +14.1 V and +15.9 V).
- d. Disconnect the voltmeter lead from the +15 V point and reconnect this lead to the -12 V point of the Main board.

e. Check—for a -12 V reading, $\pm 6\%$ (between +11.28 V and +12.72 V).

f. Disconnect the voltmeter lead from the -12 V point and reconnect this lead to the +5 V point on the Main board.

g. Check—for a +5 V reading, $\pm 6\%$ (between +4.70 V and +5.30 V).

2. Adjust 2 Vdc \emptyset and 200 mVdc \emptyset

- a. Press the VOLTS DC push button.
- b. Connect a shorting strap from the LOW connector to the VOLTS/ Ω connector on the front panel of the DM 501A.
- c. Press the 2 V range push button switch.
- d. Adjust—R1405 (2 Vdc \emptyset) for a DM 501A display reading of ± 0.000 .
- e. Press the 200 mV range push button.
- f. Adjust—R1415 (200 mVdc \emptyset), located on the Main board, for a DM 501A display reading of -00.01 to +00.01.
- g. Remove the shorting strap between the LOW and VOLTS/ Ω front panel connectors.

2A. 200 Ω Zero Adjust (SN B025410 & Up)

NOTE

The electrical shield must be removed to make the 200 Ω adjustment. The shield should be installed for all other adjustments.

- a. Push: DM 501A k Ω function button in. Push: 200 Ω range button in. Set: All other DM 501A buttons out. Connect: Shorting bar across the DM 501A LOW and VOLTS/ Ω INPUT jacks.
- b. Adjust: R1614 for a display of 00.00.
- c. Remove: Shorting bar from DM 501A.

3. Adjust Dc Voltage Ranges

- a. Select the range and required dc calibration voltage in the order listed in Table 4-15.

NOTE

The adjustment of the 2 Vdc range interacts with the setting of the 200 mV range but not vice-versa.

- b. Adjust the selected control for the required display.
- c. Return the calibrator to a minimum voltage.
- d. Remove connections.

4. Adjust AC Converter and Attenuator Compensation

- a. Press the VOLTS AC function push button.
- b. Press the 2 V range push button.
- c. Set the ac voltage source frequency to 10 kHz with an output of 0.1000 V rms.
- d. Connect the ac voltage source to the LOW connector and VOLTS/ Ω connector on the front panel.
- e. Adjust R1525 (LO Vac) for a display reading of .0997—.1002.
- f. Set the ac calibrator for a voltage of 1.9000 V rms at 10 kHz.
- g. Adjust R1537 (2 Vac) for a display reading of 1.8995—1.9005.
- h. Interaction may occur in the adjustments of R1525 and R1537. Repeat step 2, part b through part g, as needed.
- i. Adjust 20 Vac, 200 Vac, and 500 Vac ranges.

WARNING

Use an insulated shaft adjustment tool when adjusting capacitors C1114, C1128, and C1129. The input potential is connected to the metal top of these capacitors.

- j. Using Table 4-16, set the range and the required ac calibration voltage. Adjust the selected control for the required display reading.

- k. Set the ac voltage calibrator to a minimum voltage.

- l. Remove connections.

5. Adjust dB \emptyset and dB Gain

- a. Press the VOLTS AC push button.
- b. Check and note the position of the dBm/dBV internal jumper. Set the ac calibrator for 77.46 mV (dBm) or 100.00 mV (dBV) at a frequency of 10 kHz.
- c. Press the dB function push button.
- d. Press the -20 dB range push button.
- e. Adjust R1535 (dB \emptyset) for a display reading of -.1 to -.2.
- f. Set the ac calibrator for 774.6 mV (dBm) or 1.0000 V (dBV).
- g. Adjust R1528 (dB Gain) for a flashing display positive reading with the upper segment of the 1 in the most significant digit followed by the numerals 0.0.
- h. Set the ac calibrator for 7.746 mV (dBm) or 10.00 mV (dBV).
- i. Check for a flashing display negative reading with the upper segment of the 1 in the most significant digit followed by the numerals 0.0.
- j. The settings of R1535 (dB \emptyset) and R1528 (dB Gain) may need to be compromised for optimum operation within the limits specified. Refer to Tables 4-4 or 4-5.
- k. Remove the ac calibrator connections from the DM 501A.

6. Adjust HI Ohms and LO Ohms

- a. Press the k Ω function push button.
- b. Press the 20 k Ω range push button.
- c. Set all other push buttons to the out position.

- d. Set the resistance standard for 19.000 k Ω .
- e. Connect the resistance standard between the VOLTS/ Ω and LOW input connectors.
- f. With the HI-LO push button in the out position, adjust R1426 (HI Ω) for a display reading of 18.994 to 19.006.
- g. Press the HI-LO push button.
- h. Adjust R1412 (LO Ω) for a display reading of 18.994 to 19.006.
- i. Remove the resistance standard connections from the DM 501A.
- b. Connect the temperature probe to the front panel TEMP connector.
- c. Press the TEMP $^{\circ}$ C function push button.
- d. Place the temperature probe in a 0.0 $^{\circ}$ C (ice-bath) environment. Allow enough time for the display reading to stabilize.
- e. Adjust R1731 (TEMP \emptyset) for a display reading of -000.2 to +000.2.
- f. Place the temperature probe in a 100.0 $^{\circ}$ C environment. Allow enough time for the display reading to stabilize.
- g. Adjust R1831 (TEMP Set) for a display reading of 99.7 to 100.3.

7. Adjust TEMP \emptyset and TEMP Set

- a. Remove left side shield.
- h. Interaction may occur in TEMP \emptyset and TEMP Set adjustments. Repeat step 7 parts d through g, as needed.

Table 4-15
DC VOLTAGE RANGE ADJUSTMENTS

Range	Calibration Voltage	Adjust	Component Location	Display Reading
2 V	1.9000 V	R1505 (2 Vdc)	Main	1.8997—1.9003
200 mV	190.00 mV	R1504 (200 mVdc)	Main	1.8996—1.9004
20 V	19.000 V	R1104 (20 Vdc)	Attenuator	18.997—19.003
200 V	190.00 V	R1110 (200 Vdc)	Attenuator	189.97—190.03
1000 V	1000.0 V	R1114 (1000 Vdc)	Attenuator	999.80—1000.2

Table 4-16
AC VOLTAGE RANGE ADJUSTMENTS

Range	Calibration Voltage at 10 kHz	Adjust	Component Location	Display Reading
20 V	19.000	C1114 (20 Vac)	Attenuator	18.990—19.010
200 V	190.00	C1128 (200 Vac)	Attenuator	189.90—190.10
500 V	500.00	C1129 (500 Vac)	Attenuator	499.50—500.50

Vertical text on the left margin, likely bleed-through from the reverse side of the page. The text is extremely faint and difficult to read, but appears to be a list of items or a table of contents.

Free Manuals Download Website

<http://myh66.com>

<http://usermanuals.us>

<http://www.somanuals.com>

<http://www.4manuals.cc>

<http://www.manual-lib.com>

<http://www.404manual.com>

<http://www.luxmanual.com>

<http://aubethermostatmanual.com>

Golf course search by state

<http://golfingnear.com>

Email search by domain

<http://emailbydomain.com>

Auto manuals search

<http://auto.somanuals.com>

TV manuals search

<http://tv.somanuals.com>